

**UNITED STATES  
SECURITIES AND EXCHANGE COMMISSION**  
Washington, D.C. 20549

**AMENDMENT NO. 1 TO  
FORM F-4  
REGISTRATION STATEMENT  
UNDER  
THE SECURITIES ACT OF 1933**

**PRIME NUMBER HOLDING LIMITED**

(Exact Name of Registrant as Specified in Its Charter)

Cayman Islands  
(State or Other Jurisdiction of  
Incorporation or Organization)

4931  
(Primary Standard Industrial  
Classification Code Number)

Not Applicable  
(I.R.S. Employer  
Identification Number)

I/C/O NOCO-NOCO PTE. LTD.  
4 Shenton Way  
#04-06 SGX Centre 2  
Singapore 068807 +65 6970 9643  
(Address, including zip code, and telephone number, including area code, of Registrant's principal executive offices)

Cogency Global Inc.  
122 East 42nd Street, 18th Floor  
New York, NY 10168  
(Name, address, including zip code, and telephone number, including area code, of agent for service)

*Copies to:*

Arila E. Zhou, Esq.  
Ze'-ev D. Eiger, Esq.  
Robinson & Cole LLP  
Chrysler East Building  
666 Third Ave, 20<sup>th</sup> Floor  
New York, NY 10017  
Tel: 212-451-2908

Meng Ding, Esq.  
Sidley Austin  
c/o 39/F, Two Int'l Finance Centre  
8 Finance St, Central, Hong Kong  
+852 2509-7888

**Approximate date of commencement of proposed sale of the securities to the public: As soon as practicable after this Registration Statement becomes effective.**

If this Form is filed to register additional securities for an offering pursuant to Rule 462(b) under the Securities Act, check the following box and list the Securities Act registration statement number of the earlier effective registration statement for the same offering.

If this Form is a post-effective amendment pursuant to Rule 462(d) under the Securities Act, check the following box and list the Securities Act registration statement number of the earlier effective registration for the share offering.

If applicable, place an X in the box to designate the appropriate rule provision relied upon in conducting this transaction:

Exchange Act Rule 13e-4(i) (Cross-Border Issuer Tender Offer)

Exchange Act Rule 14d-1(d) (Cross-Border Third-Party Tender Offer)

Indicate by check mark whether the registrant is an emerging growth company as defined in Rule 405 of the Securities Act of 1933.

Emerging growth company

If an emerging growth company that prepares its financial statements in accordance with U.S. GAAP, indicate by check mark if the registrant has elected not to use the extended transition period for complying with any new or revised financial accounting standards† provided pursuant to Section 7(a)(2)(B) of the Securities Act.

† The term "new or revised financial accounting standard" refers to any update issued by the Financial Accounting Standards Board to its Accounting Standards Codification after April 5, 2012.

**The registrant hereby amends this registration statement on such date or dates as may be necessary to delay its effective date until the registrant shall file a further amendment which specifically states that this registration statement shall thereafter become effective in accordance with Section 8(a) of the Securities Act of 1933, as amended, or until the registration statement shall become effective on such date as the Securities and Exchange Commission, acting pursuant to said Section 8(a), may determine.**



**The information in this preliminary proxy statement/prospectus is not complete and may be changed. We may not issue these securities until the registration statement filed with the Securities and Exchange Commission is effective. This preliminary proxy statement/prospectus is not an offer to sell these securities and it is not soliciting an offer to buy these securities in any state where the offer or sale is not permitted.**

**PRELIMINARY - SUBJECT TO COMPLETION, DATED JUNE 21, 2023**

**PROXY STATEMENT FOR SPECIAL MEETING OF SHAREHOLDERS OF  
PRIME NUMBER ACQUISITION I CORP.  
and  
PROSPECTUS FOR UP TO [ ] ORDINARY SHARES  
OF  
PRIME NUMBER HOLDING LIMITED**

The board of directors of Prime Number Acquisition I Corp., a Delaware corporation (“PNAC”), has unanimously approved the Business Combination Agreement, dated December 29, 2022 (as may be amended, supplemented, or otherwise modified from time to time, the “Business Combination Agreement”), by and among Prime Number Holding Limited, an exempted company limited by shares incorporated under the laws of the Cayman Islands (“PubCo”), PNAC, Prime Number Merger Sub Inc., a Delaware corporation and a direct wholly-owned subsidiary of PubCo (“Merger Sub”), Prime Number New Sub Pte. Ltd., a Singapore private company limited by shares and a direct wholly-owned subsidiary of PubCo (“New SubCo”), NOCO-NOCO PTE. LTD., a Singapore private company limited by shares (“noco-noco”), and certain shareholders of noco-noco collectively holding a controlling interest (together with other shareholders of noco-noco subsequently joining the transactions, the “Sellers”), pursuant to which PNAC is proposing to enter into a business combination with noco-noco involving a merger and a share exchange, among which: (i) Merger Sub shall merge with and into PNAC, with PNAC as the surviving entity and a wholly-owned subsidiary of PubCo (the “Merger”), (ii) New SubCo shall acquire all of the issued and outstanding shares of noco-noco from the Sellers, and in exchange, PubCo shall issue to the Sellers the ordinary shares of PubCo, with noco-noco becoming a subsidiary of New SubCo and an indirect subsidiary of PubCo (the “Share Exchange”, and together with the Merger and the other transactions contemplated by the Business Combination Agreement, the “Business Combination”). Upon the consummation of the Business Combination, each of PNAC and noco-noco would become a subsidiary of PubCo, and PNAC stockholders and the Sellers would receive ordinary shares, par value \$0.0001 per share, of PubCo (“PubCo Ordinary Shares”) as consideration and become the shareholders of PubCo.

Pursuant to the Business Combination Agreement, upon the consummation of the Business Combination: (i) each PNAC unit (“PNAC Units”) issued and outstanding immediately prior to the effective time of the Merger shall be automatically detached and the holder thereof shall be deemed to hold one share of PNAC Class A Common Stock (defined below), one half of PNAC Warrant (defined below), and one PNAC Right (defined below); (ii) each share of PNAC Class A common stock, par value \$0.0001 per share (“PNAC Class A Common Stock”, together with PNAC Class B Common Stock, par value \$0.0001 per share, the “PNAC Common Stock”) issued and outstanding immediately prior to the effective time of the Merger shall be canceled in exchange for the right to receive one PubCo Ordinary Share, (iii) each PNAC warrant (“PNAC Warrant”) outstanding immediately prior to the effective time of the Merger shall cease to be a warrant with respect to PNAC Common Stock and be assumed by PubCo and converted into a warrant of PubCo to purchase one PubCo Ordinary Share subject to substantially the same terms and conditions prior to the effective time of the Merger; and (iv) each PNAC Right (“PNAC Right”) outstanding immediately prior to the effective time of the Merger shall cease to be a right with respect to PNAC Common Stock and be assumed by PubCo and converted into a right to receive one-eighth (1/8) of one PubCo Ordinary Share, subject to substantially the same terms and conditions prior to the effective time of the Merger. In addition, pursuant to the Business Combination Agreement, upon the consummation of the Share Exchange (i) New SubCo shall acquire the outstanding shares of noco-noco (“noco-noco Shares”) from the Sellers, (ii) in exchange, each Seller shall receive such number of newly issued PubCo Ordinary Share that is equal to the product of (a) the quotient of (i) \$1,350,000,000 (the “noco-noco Valuation”), divided by (ii) the price per PubCo Ordinary Share that equals to the redemption price of each share of PNAC Class A Common Stock in connection with the Business Combination (the “PubCo Per Share Price”), multiplied by (b) such Seller’s Pro Rata Portion as set out in the Allocation Schedule of the Business Combination Agreement. In addition, pursuant to corporate actions that PubCo shall take prior to the effective time of the Merger, PubCo shall issue 806,250 PubCo Ordinary Shares to such holders of the PNAC rights, with each PNAC right converted into a right to receive one-eighth (1/8) of one PubCo Ordinary Share upon the effective time of the Merger.

Pursuant to our current effective amended and restated certificate of incorporation, dated May 10, 2022 and as amended by a certificate of amendment dated May 17, 2023 (together, the “Existing PNAC Charter”), we have until July 17, 2023 to consummate the Business Combination (or November 17, 2023, if fully extended pursuant to the Existing PNAC Charter).

For details on the transactions involved in the Business Combination, see “*Questions and Answers about the Proposals—What is expected to happen in the Business Combination?*”

PNAC stockholders are being asked to consider a vote upon the Business Combination and certain proposals related thereto as described in this proxy statement/prospectus. As a result of, and upon consummation of the Business Combination, noco-noco shall become a subsidiary of PubCo, and PubCo shall become a new public company owned by the prior holders of PNAC Common Stock, the prior holders of PNAC Rights, the prior holders of PNAC Warrants, the Sellers, and certain third-party investors of a financing in connection with the Business Combination.

Prior to the closing of the Business Combination (the “Closing”), PubCo shall be renamed as “noco-noco Inc.” PubCo has applied for listing, to be effective upon the consummation of the Business Combination, of the PubCo Ordinary Shares on the Nasdaq Capital Market under the symbol “\_\_\_\_\_”.

No compensation of any kind, including finder’s and consulting fees, will be paid by PNAC to our Sponsors, officers, directors or any of our or their respective affiliates, for services rendered prior to or in connection with the completion of the Business Combination. However, these individuals will be reimbursed for any out-of-pocket expenses related to identifying and investigating potential target businesses and completing the Business Combination. Certain directors and officers of PNAC are direct or indirect members of the Sponsor, and, following the consummation of the Business Combination, each such director and officer of PNAC is entitled to receive PubCo Ordinary Shares and PubCo Warrants then held by the Sponsors as further described in “*Security Ownership of Certain Beneficial Owners and Management.*” for more information.

On October 25, 2022, PNAC entered into an engagement letter with Prime Number Capital LLC (“PNCPS”) and WestPark Capital, Inc. (“WestPark”), the representatives of the underwriters for the initial public offering of PNAC (the “IPO”), to act as the financial advisors to PNAC (the “Financial Advisory Engagement”). In connection with the Financial Advisory Engagement, PNCPS and Westpark will not receive any additional compensation for services rendered under the Financial Advisory Engagement except the deferred underwriting fee in the amount of \$2,257,500 as provided in a certain underwriting agreement for the IPO dated May 12, 2022 among PNAC, PNCPS and Westpark. PNAC also agrees to reimburse PNCPS and WestPark up to \$20,000 for its reasonable out-of-pocket expenses in connection with the performance of their services thereunder. In addition, on the same date, PNAC separately entered into an engagement letter with PNCPS who would, among others, use its reasonable efforts in identifying and introducing potential targets, value potential business combination and assess the proposed structure for business combination and assist in managing the process and other related service (the “Business Combination Advisory Engagement”). On January 31, 2023, PNAC entered into an amendment to the foregoing engagement letter to set forth the compensation for the Business Combination Advisory Engagement. In connection with the Business Combination Advisory Engagement, PNAC shall pay or cause the surviving entities of the Business Combination to pay PNCPS \$500,000 in cash and issue PNCPS 609,756 PubCo Ordinary Shares upon the Closing of the Business Combination. PNAC also agrees to reimburse PNCPS up to \$5,000 for its reasonable out-of-pocket expenses in rendering their services. In addition, on April 30, 2023, PNAC entered into a Placement Agent Agreement with PNCPS, pursuant to which PNCPS shall act as the placement agent for the solicitation and placement of securities of PNAC, in exchange for a placement fee of 7% of the aggregate gross proceeds received by PNAC from the sales of such securities. Further details of these arrangements are set forth in the section entitled “*Business Combination Proposal—Certain Engagements in Connection with the Business Combination and Related Transactions.*”

Immediately after the consummation of the Business Combination, 3DOM Alliance will hold approximately [68.0]% (under the no redemption scenario) or approximately [71.3]% (under the maximum redemption scenario) of PubCo’s voting power. As a result, PubCo will be a “controlled company” within the meaning of the corporate governance standards of the Nasdaq listing rules. Under these rules, a company of which more than 50% of the voting power in the election of directors is held by an individual, group or another company is a “controlled company” and may elect not to comply with certain corporate governance requirements. See “*Risk Factors—Risks Related to PubCo and Ownership of PubCo’s Shares—Because we are a “controlled company” as defined in the Nasdaq Stock Market Rules, you may not have protections of certain corporate governance requirements which otherwise are required by Nasdaq’s rules*” and “*Risk Factors—Risks Related to PubCo and Ownership of PubCo’s Shares—PubCo is a company incorporated in the Cayman Islands and will qualify as a foreign private issuer within the meaning of the rules under the Exchange Act, and as such PubCo is exempt from certain provisions applicable to United States domestic public companies.*”

Pubco is, and will be after the consummation of the Business Combination, considered a “foreign private issuer” under the Exchange Act and therefore exempt from certain rules under the Exchange Act, including the proxy rules, which impose certain disclosure and procedural requirements for proxy solicitations for U.S. and other issuers. Moreover, Pubco is not required to file periodic reports and financial statements with the SEC as frequently or within the same time frames as U.S. companies with securities registered under the Exchange Act, although it may elect to file certain periodic reports and financial statements with the SEC on a voluntary basis on the forms used by U.S. domestic issuers. Pubco is not required to comply with Regulation FD, which imposes restrictions on the selective disclosure of material information to shareholders. In addition, Pubco’s officers, directors and principal shareholders are exempt from the reporting and short-swing profit recovery provisions of Section 16 of the Exchange Act and the rules under the Exchange Act with respect to their purchases and sales of Pubco’s securities. Accordingly, after the Business Combination, if you continue to hold Pubco’s securities, you may receive less or different information about Pubco than you currently receive about PNAC or that you would receive about a U.S. domestic public company.

In addition, as a “foreign private issuer”, Pubco is permitted to follow certain home-country corporate governance practices in lieu of certain Nasdaq requirements. A foreign private issuer must disclose in its annual reports filed with the SEC each Nasdaq requirement with which it does not comply followed by a description of its applicable home country practice. Pubco currently intends to follow some, but not all, of the corporate governance requirements of Nasdaq. With respect to the corporate governance requirements of Pubco that it does follow, Pubco cannot give assurances that it will continue to follow such corporate governance requirements in the future, and may therefore in the future, rely on available Nasdaq exemptions that would allow Pubco to follow its home country practice. Unlike the requirements of Nasdaq, Pubco is not required, under the corporate governance practice and requirements in the Cayman Islands, to have its board consist of a majority of independent directors, nor is Pubco required to have a compensation committee, a nominating or a corporate governance committee consisting entirely of independent directors, or to have regularly scheduled executive sessions with only independent directors each year. Such Cayman Islands home country practices may afford less protection to holders of Ordinary Shares. For additional information regarding the home country practices Pubco intends to follow in lieu of Nasdaq requirements, see “*Management of Pubco Following the Business Combination—Foreign Private Issuer Status.*”

Pubco would lose its status as a “foreign private issuer” under current SEC rules and regulations if more than 50% of Pubco’s outstanding voting securities becomes directly or indirectly held of record by U.S. holders and one of the following is true: (i) the majority of Pubco’s directors or executive officers are U.S. citizens or residents; (ii) more than 50% of Pubco’s assets are located in the United States; or (iii) Pubco’s business is administered principally in the United States. If Pubco loses its status as a foreign private issuer in the future, it will no longer be exempt from the rules described above and, among other things, will be required to file periodic reports and annual and quarterly financial statements as if it were a company incorporated in the United States. If this were to happen, Pubco would likely incur substantial costs in fulfilling these additional regulatory requirements and members of Pubco’s management would likely have to divert time and resources from other responsibilities to ensuring these additional regulatory requirements are fulfilled. PubCo also expect that if it were required to comply with the rules and regulations applicable to U.S. domestic issuers, it would make it more difficult and expensive for PubCo to obtain director and officer liability insurance, and it may be required to accept reduced coverage or incur substantially higher costs to obtain coverage. These rules and regulations could also make it more difficult for PubCo to attract and retain qualified members of its board of directors.

The Business Combination Agreement is attached to this proxy statement/prospectus as Annex A. Upon the consummation of the Merger, PubCo shall adopt the amended and restated memorandum and articles of association (the “Amended PubCo Charter”) in the form attached to this proxy statement/prospectus as Annex B.

Proposals to approve the Business Combination Agreement and the other matters discussed in this proxy statement/prospectus shall be presented at the Special Meeting of shareholders of PNAC scheduled to be held on \_\_\_\_\_, 2023.

This proxy statement/prospectus provides you with detailed information about the Business Combination and other matters to be considered at the Special Meeting of PNAC stockholders. We encourage you to carefully read this entire document. **You should, in particular, carefully consider the risk factors described in “[Risk Factors](#)” beginning on page 53 of this proxy statement/prospectus.**

**The board of directors of PNAC has unanimously approved and adopted the Business Combination Agreement and unanimously recommends that the PNAC stockholders vote FOR all of the proposals presented to the shareholders. When you consider the board of directors’ recommendation of these proposals,**

you should keep in mind that certain of PNAC's directors and officers have interests in the Business Combination. See the section entitled "The Business Combination Proposal—Interests of PNAC's Directors and Officers in the Business Combination."

This proxy statement/prospectus is dated \_\_\_\_\_, 2023 and is first being mailed to PNAC stockholders on or about \_\_\_\_\_, 2023.

**NEITHER THE SECURITIES AND EXCHANGE COMMISSION NOR ANY STATE SECURITIES REGULATORY AGENCY HAS APPROVED OR DISAPPROVED THE TRANSACTIONS DESCRIBED IN THIS PROXY STATEMENT/PROSPECTUS OR ANY OF THE SECURITIES TO BE ISSUED IN THE BUSINESS COMBINATION, PASSED UPON THE MERITS OR FAIRNESS OF THE BUSINESS COMBINATION OR RELATED TRANSACTIONS OR PASSED UPON THE ADEQUACY OR ACCURACY OF THE DISCLOSURE IN THIS PROXY STATEMENT/PROSPECTUS. ANY REPRESENTATION TO THE CONTRARY CONSTITUTES A CRIMINAL OFFENSE.**

#### ADDITIONAL INFORMATION

No person is authorized to give any information or to make any representation with respect to the matters that this proxy statement/prospectus describes other than those contained in this proxy statement/ prospectus, and, if given or made, the information or representation must not be relied upon as having been authorized by PubCo, PNAC or noco-noco. This proxy statement/prospectus does not constitute an offer to sell or a solicitation of an offer to buy securities or a solicitation of a proxy in any jurisdiction where, or to any person to whom, it is unlawful to make such an offer or a solicitation. Neither the delivery of this proxy statement/prospectus nor any distribution of securities made under this proxy statement/prospectus will, under any circumstances, create an implication that there has been no change in the affairs of PubCo, PNAC or noco-noco since the date of this proxy statement/prospectus or that any information contained herein is correct as of any time subsequent to such date.

**Prime Number Acquisition I Corp.**  
**1129 Northern Blvd., Suite 404**  
**Manhasset, NY 11030**

Dear Prime Number Acquisition I Corp. Shareholders:

You are cordially invited to attend the Special meeting (the “Special Meeting”) of Prime Number Acquisition I Corp., a corporation incorporated under the laws of the State of Delaware (“PNAC”), at AM Eastern time, on , 2023 virtually at [https://\[ \]](https://[ ]), and on such other date and at such other place to which the meeting may be adjourned. We are pleased to utilize virtual shareholder meeting technology to (i) provide ready access and cost savings for PNAC stockholders and PNAC, and (ii) to promote social distancing pursuant to guidance provided by the U.S. Centers for Disease Control and Prevention (“CDC”) due to COVID-19. The virtual meeting format allows attendance from any location in the world. In light of public health concerns regarding COVID-19, virtual attendance is encouraged.

The Special Meeting shall be held for the following purpose:

1. to consider and vote upon a proposal, which is referred to herein as the “Business Combination Proposal,” to (a) adopt and approve the Business Combination Agreement and other Transaction Documents (as defined in the Business Combination Agreement), (b) approve the Business Combination which includes (i) the Merger between PNAC and Merger Sub with PNAC surviving the Merger and becoming a wholly owned subsidiary of PubCo, (ii) the Share Exchange whereby the Sellers will exchange their noco-noco Shares for newly issued PubCo Ordinary Shares and noco-noco will be an indirect subsidiary of PubCo, and (iii) other transactions contemplated therein. The Business Combination Agreement is attached to this proxy statement/prospectus as Annex A;
2. to consider and vote upon a proposal to approve, by special resolution, assuming the Business Combination Proposal is approved and adopted, the amended and restated memorandum and articles of association of PubCo (as the surviving company in the Business Combination) upon completion of the Merger (the “Governing Documents Proposal”). The form of the amended and restated memorandum and articles of association of PubCo is attached to this proxy statement/prospectus as Annex B;
3. to consider and approve, if presented, a proposal to adjourn the Special Meeting to a later date or dates (the “Adjournment Proposal”).

Each of the Business Combination Proposal and the Governing Documents Proposal is cross-conditioned on the approval of each other. **The Adjournment Proposal is not conditioned upon the approval of any other proposal set forth in this proxy statement/prospectus.**

As further described in the accompanying proxy statement/prospectus, subject to the terms and conditions of the Business Combination Agreement, the following transactions will occur:

1. (i) PNAC shall merge with and into Merger Sub, with PNAC being the surviving company, (ii) New SubCo shall acquire all of the issued and outstanding shares of noco-noco from the shareholders of noco-noco, or the Sellers, and in exchange, PubCo shall issue to the Sellers the PubCo Ordinary Shares with noco-noco becoming a subsidiary of New SubCo and indirect subsidiary of PubCo;
2. (i) each (a) PNAC Unit issued and outstanding immediately prior to the effective time of the Merger shall be automatically detached and the holder thereof shall be deemed to hold one share of PNAC Class A Common Stock, one-half of PNAC Warrant, and one PNAC Right; (b) share of PNAC Class A Common Stock issued and outstanding immediately prior to the effective time of the Merger shall be canceled in exchange for the right to receive one PubCo Ordinary Share, (ii) each PNAC Warrant outstanding immediately prior to the effective time of the Merger shall cease to be a warrant with respect to PNAC Common Stock and be assumed by PubCo and converted into a warrant of PubCo to purchase one PubCo Ordinary Share, subject to substantially the same terms and conditions prior to the effective time of the Merger; (iii) each PNAC Right outstanding immediately prior to the effective time of the Merger shall cease to be a right with respect to PNAC Common Stock and be converted into a right to receive one-eighth (1/8) of one PubCo Ordinary Share, subject to substantially the same terms and conditions prior to the effective time of the Merger; and

3. following the Merger, subject to the terms and conditions set forth in the Business Combination Agreement, (i) each Seller shall transfer its ordinary shares of noco-noco to New SubCo, (ii) each Seller shall receive such number of newly issued PubCo Ordinary Shares that is equal to the product of (a) the quotient of (i) \$1,350,000,000 (the “noco-noco Valuation”), divided by (ii) the price per PubCo Ordinary Share that equals to the redemption price of each share of PNAC Class A Common Stock in connection with the Business Combination (the “PubCo Per Share Price”), multiplied by (b) such Seller’s Pro Rata Portion as set out in the Allocation Schedule of the Business Combination Agreement (the “Share Exchange”, and together with the Merger and the other transactions contemplated by the Business Combination Agreement, the “Business Combination”). In addition, pursuant to corporate actions that PubCo shall take prior to the effective time of the Merger, PubCo shall issue 806,250 PubCo Ordinary Shares to such holders of the PNAC rights, with each PNAC right converted into a right to receive one-eighth (1/8) of one PubCo Ordinary Share upon the effective time of the Merger.

As provided in the Business Combination Agreement, PubCo, PNAC and the New SubCo shall use reasonable best efforts to obtain equity financing (the “Transaction Financing”) on the terms mutually agreed to by noco-noco and PNAC, in an amount that is at least \$20,000,000 prior to or upon the Share Exchange Closing. We do not expect that PNAC’s Sponsors, directors, officers and their affiliates will participate in the Transaction Financing.

In connection with the Business Combination, certain related agreements will be entered into prior to or concurrently with the closing of the Business Combination, including Lock-up Agreement, Registration Rights Agreement, Warrant Assumption Agreement and transaction documents in connection with the Transaction Financing (each as defined in the accompanying proxy statement/prospectus). See “*The Business Combination Proposal—Related Agreements*” in the accompanying proxy statement/prospectus for more information.

Under the Business Combination Agreement, the approval of the Business Combination Proposal and the Governing Documents Proposal by the requisite vote of PNAC stockholders is a condition to the consummation of the Business Combination.

The Adjournment Proposal, if adopted, shall allow the Chairman of the Special Meeting to adjourn the Special Meeting to a later date or dates, if necessary. In no event shall PNAC solicit proxies to adjourn the Special Meeting or consummate the Business Combination and related transactions beyond the date by which it may properly do so under PNAC’s amended and restated certificate of incorporation dated May 10, 2022, which was amended by a certificate of amendment dated May 17, 2023 (together with the amended and restated certificate of incorporation, the “Existing PNAC Charter”), and Delaware General Corporation Law (the “DGCL”). The purpose of the Adjournment Proposal is to provide more time to meet the requirements that are necessary to consummate the Business Combination and related transactions. The Adjournment Proposal is not conditioned upon the approval of any other proposal set forth in the accompanying proxy statement/prospectus.

Each of these proposals is more fully described in the accompanying proxy statement/prospectus, which each PNAC stockholder is encouraged to read carefully and in its entirety.

Pursuant to the Existing PNAC Charter, a holder (a “PNAC Public Stockholder”) of shares of PNAC’s Class A Common Stock sold in PNAC IPO (including the exercise of over-allotment option) (such shares, “PNAC Public Shares”) may request that PNAC redeem all or a portion of such PNAC Public Shares for cash in connection with the completion of the Business Combination. The redemption rights include the requirement that a holder must identify itself in writing as a beneficial holder and provide its legal name, phone number and address to VStock in order to validly redeem its shares. **PNAC Public Stockholders may elect to redeem their PNAC Public Shares even if they vote “for” the Business Combination Proposal.** If the Business Combination is not consummated, the PNAC Public Shares will be returned to the respective holder, broker or bank. If the Business Combination is consummated, and if a PNAC Public Stockholder properly exercises its right to redeem all or a portion of the PNAC Public Shares that it holds and timely delivers its share certificates (if any) and other redemption forms (as applicable) to VStock, PNAC will redeem such PNAC Public Shares for a per-share price, payable in cash, equal to the pro rata portion of the amount on deposit in the Trust Account as of two business days prior to the consummation of the Business Combination, including interest earned on the funds held in the Trust Account and not previously released to PNAC. For illustrative purposes, as of December 31, 2022, the redemption price was approximately \$10.34 per share less any owed but unpaid taxes on the funds in the Trust Account. If a PNAC Public Stockholder exercises its redemption rights in full, then it will be electing to exchange its PNAC Public Shares for cash and will no longer own PNAC Public Shares. See “*Special Meeting of PNAC stockholders—Redemption Rights*” in the accompanying proxy statement/prospectus for a detailed description of the procedures to be followed if you wish to redeem your PNAC Public Shares for cash.

Notwithstanding the foregoing, a PNAC Public Stockholder, together with any affiliate of such PNAC Public Stockholder or any other person with whom such PNAC Public Stockholder is acting in concert or as a “group” (as defined in Section 13(d)(3) of the Securities Exchange Act of 1934, as amended (“Exchange Act”)), will be restricted from redeeming its PNAC Public Shares with respect to more than an aggregate of 15% of the PNAC Public Shares. Accordingly, if a PNAC Public Stockholder, alone or acting in concert or as a group, seeks to redeem more than 15% of the PNAC Public Shares, then any such shares in excess of that 15% limit would not be redeemed.

The Prime Number Acquisition LLC (“Sponsor A”), Glorious Capital LLC (“Sponsor B”, together with Sponsor A, the “Sponsors”), and the officers and directors of PNAC (together with Sponsors, and the affiliates of the Sponsors, officers and directors of PNAC, the “PNAC Initial Stockholders”) have agreed to, among other things, vote all of their PNAC Founder Shares and PNAC Private Shares in favor of the proposals being presented at the Special Meeting and waive their redemption rights with respect to their PNAC Founder Shares and PNAC Private Shares in connection with the consummation of the Business Combination. As of the date of this proxy statement/prospectus, the PNAC Initial Stockholders own approximately 29.05% of the issued and outstanding shares of PNAC Common Stock.

The Business Combination Agreement is subject to the satisfaction or waiver of certain other closing conditions as described in the accompanying proxy statement/prospectus. There can be no assurance that the parties to the Business Combination Agreement would waive any such closing condition. In addition, in no event will PNAC redeem PNAC Public Shares in an amount that would cause the net tangible assets (as determined in accordance with Rule 3a51-1(g)(1) of the Exchange Act) of PNAC or the entity that succeeds PNAC as a public company to be less than \$5,000,001 after giving effect to the transactions contemplated by the Business Combination Agreement.

PNAC is providing the accompanying proxy statement/prospectus and accompanying proxy card to PNAC stockholders in connection with the solicitation of proxies to be voted at the Special Meeting and at any adjournments of the Special Meeting. Information about the Special Meeting, the Business Combination and other related business to be considered by PNAC stockholders at the Special Meeting is included in the accompanying proxy statement/prospectus. **Whether or not you plan to attend the Special Meeting, all of PNAC stockholders should read the accompanying proxy statement/prospectus, including the Annexes and other documents referred to therein, carefully and in their entirety. You should also carefully consider the risk factors described in “Risk Factors” beginning on page 53 of the accompanying proxy statement/prospectus.**

**After careful consideration, PNAC’s board of directors has unanimously approved the Business Combination and determined that the Business Combination Proposal, the Governing Documents Proposal and the Adjournment Proposal are advisable and fair to and in the best interest of PNAC and unanimously recommends that you vote or give instruction to vote “FOR” the Business Combination Proposal, “FOR” the Governing Documents Proposal and “FOR” the Adjournment Proposal, if presented. When you consider the board of directors’ recommendation of these proposals, you should keep in mind that our directors and our officers have interests in the Business Combination that may conflict with your interests as a shareholder. See the section entitled “The Business Combination Proposal—Interests of PNAC’s Directors and Officers in the Business Combination.” in the accompanying proxy statement/prospectus for a further discussion of these considerations.**

The approval of each of Business Combination Proposal and the Governing Documents Proposal requires the affirmative vote of the holders of a majority of the shares of PNAC Common Stock cast in respect of the relevant proposal and entitled to vote thereon at the Special Meeting. The Adjournment Proposal is not conditioned upon the approval of any other proposal set forth in this proxy statement/prospectus. The approval of the Adjournment Proposal if presented will require the consent of the meeting, which means a simple majority of the votes which are cast by those shareholders of PNAC who are present, in person or by proxy, and vote thereupon at the Special Meeting.

If the Business Combination Proposal is not approved, the Governing Documents Proposal will not be presented to PNAC stockholders for a vote.

**Your vote is important regardless of the number of shares you own. Whether or not you plan to attend the Special Meeting, please sign, date, vote and return the enclosed proxy card as soon as possible in the envelope provided to make sure that your shares are represented at the Special Meeting. If your shares are held in “street name” or are in a margin or similar account, you should contact your broker or bank to ensure that votes related to the shares you beneficially own are properly counted. The Business Combination will be consummated only if the Business Combination Proposal and the Governing Documents Proposal are approved at the Special Meeting. Each of the Business Combination Proposal and the Governing Documents Proposal is cross-conditioned on the approval of each other. The Adjournment Proposal is not conditioned upon the approval of any other proposal set forth in this proxy statement/prospectus.**

If you sign, date and return your proxy card without indicating how you wish to vote, your proxy will be voted FOR each of the proposals presented at the Special Meeting. If you fail to return your proxy card or fail to instruct your bank, broker or other nominee how to vote, and do not attend the Special Meeting in person or virtually, the effect will be, among other things, that your shares will not be counted for purposes of determining whether a quorum is present at the Special Meeting. If you are a shareholder of record and you attend the Special Meeting and wish to vote in person, you may withdraw your proxy and vote in person.

**TO EXERCISE YOUR REDEMPTION RIGHTS, YOU MUST DEMAND IN WRITING THAT YOUR PNAC COMMON STOCK BE REDEEMED FOR A PRO RATA PORTION OF THE FUNDS HELD IN THE TRUST ACCOUNT AND TENDER YOUR SHARES TO OUR TRANSFER AGENT AT LEAST TWO BUSINESS DAYS BEFORE THE SCHEDULED DATE OF THE SPECIAL MEETING. IN ORDER TO EXERCISE YOUR REDEMPTION RIGHT, YOU NEED TO IDENTIFY YOURSELF AS A BENEFICIAL HOLDER AND PROVIDE YOUR LEGAL NAME, PHONE NUMBER AND ADDRESS IN YOUR WRITTEN DEMAND. YOU MAY TENDER YOUR SHARES BY EITHER DELIVERING YOUR SHARE CERTIFICATE TO THE TRANSFER AGENT OR BY DELIVERING YOUR SHARES ELECTRONICALLY USING THE DEPOSITORY TRUST COMPANY’S DWAC (DEPOSIT WITHDRAWAL AT CUSTODIAN) SYSTEM. IF THE BUSINESS COMBINATION IS NOT COMPLETED, THEN THESE SHARES SHALL BE RETURNED TO YOU OR YOUR ACCOUNT. IF YOU HOLD THE SHARES IN STREET NAME, YOU NEED TO INSTRUCT THE ACCOUNT EXECUTIVE AT YOUR BROKER, BANK OR OTHER NOMINEE TO WITHDRAW THE SHARES FROM YOUR ACCOUNT IN ORDER TO EXERCISE YOUR REDEMPTION RIGHTS. SEE “SPECIAL MEETING OF PNAC STOCKHOLDERS—REDEMPTION RIGHTS” FOR MORE SPECIFIC INSTRUCTIONS.**



On behalf of PNAC's board of directors, I would like to thank you for your support and look forward to the successful completion of the Business Combination.

Sincerely,

Dongfeng Wang  
Chairman of the Board of Directors

NEITHER THE SECURITIES AND EXCHANGE COMMISSION NOR ANY STATE SECURITIES REGULATORY AGENCY HAS APPROVED OR DISAPPROVED THE TRANSACTIONS DESCRIBED IN THE ACCOMPANYING PROXY STATEMENT/PROSPECTUS, PASSED UPON THE MERITS OR FAIRNESS OF THE BUSINESS COMBINATION OR RELATED TRANSACTIONS OR PASSED UPON THE ADEQUACY OR ACCURACY OF THE DISCLOSURE IN THE ACCOMPANYING PROXY STATEMENT/PROSPECTUS. ANY REPRESENTATION TO THE CONTRARY CONSTITUTES A CRIMINAL OFFENSE.

The accompanying proxy statement/prospectus is dated \_\_\_\_\_, 2023, and is first being mailed to shareholders on or about \_\_\_\_\_, 2023.

**PRIME NUMBER ACQUISITION I CORP.**  
**NOTICE OF SPECIAL MEETING**  
**TO BE HELD ON                      , 2023**

TO THE SHAREHOLDERS OF PRIME NUMBER ACQUISITION I CORP.:

On behalf of the board of directors of Prime Number Acquisition I Corp. (“PNAC,” “we,” “our” or “us”), a Delaware corporation, we are pleased to enclose the proxy statement/prospectus relating to the proposed business combination as provided in the Business Combination Agreement dated December 29, 2022 (as may be amended, supplemented, or otherwise modified from time to time, the “Business Combination Agreement”), by and among Prime Number Holding Limited, an exempted company limited by shares incorporated under the laws of the Cayman Islands (“PubCo”), PNAC, Prime Number Merger Sub Inc., a Delaware corporation company and a direct wholly-owned subsidiary of PubCo (“Merger Sub”), Prime Number New Sub Pte. Ltd., a Singapore private company limited by shares and a direct wholly-owned subsidiary of PubCo (“New SubCo”), NOCO-NOCO PTE. LTD., a Singapore private company limited by shares (“noco-noco”), and certain shareholders of noco-noco collectively holding a controlling interest (together with other shareholders of noco-noco subsequently joining the transactions, the “Sellers”). Pursuant to the Business Combination Agreement, among others: (i) Merger Sub shall merger with and into PNAC, with PNAC as the surviving entity and a wholly-owned subsidiary of PubCo (the “Merger”), (ii) New SubCo shall acquire all of the issued and outstanding shares of noco-noco from the Sellers, and in exchange, PubCo shall issue to the Sellers the ordinary shares of PubCo, with noco-noco becoming a subsidiary of New SubCo and an indirect subsidiary of PubCo (the “Share Exchange”, and together with the Merger and the other transactions contemplated by the Business Combination Agreement, the “Business Combination”). Upon the consummation of the Business Combination, each of PNAC and noco-noco would become a subsidiary of PubCo, and PNAC stockholders and the Sellers would receive ordinary shares, par value \$0.0001 per share, of PubCo (“PubCo Ordinary Shares”) as consideration and become the shareholders of PubCo. Prior to the closing of the Business Combination (the “Closing”), PubCo shall be renamed as “noco-noco Inc.” PubCo has applied for listing, to be effective upon the consummation of the Business Combination, of its ordinary shares, par value \$0.0001 per share (“PubCo Ordinary Shares”) on the Nasdaq Capital Market under the symbol “ ”.

NOTICE IS HEREBY GIVEN that an Special meeting of shareholders (the “Special Meeting”) of PNAC shall be held at                      AM Eastern time, on                      , 2023 virtually at                      . In light of public health concerns regarding COVID-19, virtual attendance is encouraged and attendees of the physical meeting are required to adhere to the then prevailing COVID-19 measures and regulations implemented by the venue provider and state and local authorities, including, but not limited to, with respect to vaccination, mask-wearing and testing. You are cordially invited to attend the Special Meeting, to conduct the following items of business and/or consider, and if thought fit, approve the following proposals:

**Proposal No. 1—the Business Combination Proposal**—to consider and vote upon a proposal, which is referred to herein as the “Business Combination Proposal,” to (a) adopt and approve the Business Combination Agreement and other Transaction Documents (as defined in the Business Combination Agreement), (b) approve the Business Combination which includes (i) the Merger between PNAC and Merger Sub with PNAC surviving the Merger and becoming a wholly owned subsidiary of PubCo, (ii) the Share Exchange whereby the Sellers will exchange their noco-noco Shares for newly issued PubCo Ordinary Shares and noco-noco will be an indirect subsidiary of PubCo, and (iii) other transactions contemplated therein. The Business Combination Agreement is attached to this proxy statement/prospectus as Annex A;

**Proposal No. 2—the Governing Documents Proposal**—to consider and vote upon a proposal to approve, by special resolution, assuming the Business Combination Proposal is approved and adopted, the amended and restated memorandum and articles of association of PubCo (as the surviving company in the Business Combination) (the “Amended PubCo Charter”) upon completion of the Merger (the “Governing Documents Proposal”). The form of the amended and restated memorandum and articles of association of PubCo is attached to this proxy statement/prospectus as Annex B which among others, include:

- to change the share structure from a multi-class share structure of PNAC to a single class share structure of PubCo;
- to change the authorized capital of PNAC of 20,500,000 shares of Common Stock (20,000,000 shares of PNAC Class A Common Stock, 100,000 shares of PNAC Class B Common Stock and 400,000 shares of PNAC preferred stock) to PubCo’s authorized capital of \$50,000 divided into 500,000,000 PubCo Ordinary Shares of a par value of \$0.0001 each;
- to enable appointment of directors of PubCo by Ordinary Resolutions (as defined in the Amended PubCo Charter) or by the directors and to set forth a board of directors of PubCo without a classified board consisting of at least three directors; and
- to remove the provisions related to PubCo’s status as a blank check company, as these will not be applicable to PubCo upon consummation of the Business Combination.

**Proposal No. 3—the Adjournment Proposal**—to consider and vote upon a proposal to adjourn the Special Meeting to a later date or dates to be determined by the chairman of the Special Meeting, is hereby approved in all respects.

The approval of each of Business Combination Proposal and the Governing Documents Proposal requires the affirmative vote of the holders of a majority of the shares of PNAC Common Stock in respect of the relevant proposal and entitled to vote thereon at the Special Meeting. The Adjournment Proposal is not conditioned upon the approval of any other proposal set forth in this proxy statement/prospectus. The approval of the Adjournment Proposal if presented will require the consent of the meeting, which means a simple majority of the votes which are cast by those shareholders of PNAC who are present, in person or by proxy, and vote thereupon at the Special Meeting. An abstention or broker non-vote will be counted towards the quorum requirement but will not count as a vote cast at the Special Meeting.

Under the Business Combination Agreement, the approval of the Business Combination Proposal and the Governing Documents Proposal by the requisite vote of PNAC stockholders is a condition to the consummation of the Business Combination. The Adjournment Proposal, if adopted, shall allow the chairman of the Special Meeting to adjourn the Special Meeting to a later date or dates, if necessary. In no event shall PNAC solicit proxies to adjourn the Special Meeting or consummate the Business Combination and related transactions beyond the date by which it may properly do so under PNAC's amended and restated certificate of incorporation dated May 10, 2022, which was amended by a certificate of amendment dated May 17, 2023 (together with the amended and restated certificate of incorporation, the "Existing PNAC Charter"), and Delaware General Corporation Law (the "DGCL"). The purpose of the Adjournment Proposal is to provide more time to meet the requirements that are necessary to consummate the Business Combination and related transactions. The Adjournment Proposal is not conditioned upon the approval of any other proposal set forth in the accompanying proxy statement/prospectus.

These items of business are described in the attached proxy statement/prospectus, which we encourage you to read in its entirety before voting.

Only holders of record of PNAC Common Stock at the close of business on \_\_\_\_\_, 2023 are entitled to notice of the meeting and to vote at the meeting and any adjournments or postponements of the meeting.

This proxy statement/prospectus and accompanying proxy card is being provided to PNAC stockholders in connection with the solicitation of proxies to be voted at the Special Meeting and at any adjournment of the Special Meeting. **Whether or not you plan to attend the Special Meeting, all of PNAC's shareholders are urged to read this proxy statement/prospectus, including the Annexes and the documents referred to herein, carefully and in their entirety. You should also carefully consider the risk factors described in "Risk Factors" beginning on page 53 of this proxy statement/prospectus.**

**After careful consideration, PNAC's board of directors has unanimously approved the Business Combination and determined that the Business Combination Proposal, the Governing Documents Proposal and the Adjournment Proposal are advisable and fair to and in the best interest of PNAC and unanimously recommends that you vote or give instruction to vote "FOR" the Business Combination Proposal, FOR" the Governing Documents Proposal and "FOR" the Adjournment Proposal, if presented. When you consider the board of directors' recommendation of these proposals, you should keep in mind that our directors and our officers have interests in the Business Combination that may conflict with your interests as a stockholder. See the section entitled "The Business Combination Proposal—Interests of PNAC's Directors and Officers in the Business Combination" in the accompanying proxy statement/prospectus for a further discussion of these considerations.**

Pursuant to the Existing PNAC Charter, a PNAC Public Stockholder may request of PNAC that PNAC redeem all or a portion of its PNAC Public Shares for cash if the Business Combination is consummated. As a holder of PNAC Public Shares, you will be entitled to receive cash for any PNAC Public Shares to be redeemed only if, prior to or on \_\_\_\_\_, 2023 (two business days before the Special Meeting), you:

(i) hold PNAC Public Shares;

(ii) submit a written request to VStock Transfer, LLC ("VStock"), PNAC's transfer agent, in which you (a) request that PNAC redeem all or a portion of your PNAC Public Shares for cash, and (b) identify yourself as the beneficial holder of the PNAC Public Shares and provide your legal name, phone number and address; and

(iii) deliver share certificates (if any) and other redemption forms (as applicable) to VStock, PNAC's transfer agent, physically or electronically through The Depository Trust Company.

PNAC Public Stockholders must complete the procedures for electing to redeem their PNAC Public Shares in the manner described above prior to or on \_\_\_\_\_, 2023 (two business days before the Special Meeting) in order for their PNAC Public Shares to be redeemed.

If the Business Combination is not consummated, the PNAC Public Shares will be returned to the respective holder, broker or bank. If the Business Combination is consummated, and if a PNAC Public Stockholder properly exercises its right to redeem all or a portion of the PNAC Public Shares that it holds and timely delivers its share certificates (if any) and other redemption forms (as applicable) to VStock, PNAC will redeem such PNAC Public Shares for a per-share price, payable in cash, equal to the pro rata portion of the amount on deposit in the Trust Account as of two business days prior to the consummation of the Business Combination, including interest earned on the funds held in the Trust Account and not previously released to PNAC.

For illustrative purposes, as of December 31, 2022, this would have amounted to approximately \$10.34 per issued and outstanding share less any owed but unpaid taxes on the funds in the Trust Account. There are currently no owed but unpaid income taxes on the funds in the Trust Account. However, the proceeds deposited in the Trust Account could become subject to the claims of PNAC's creditors, if any, which would have priority over the claims of PNAC stockholders. Therefore, the per share distribution from the Trust Account in such a situation may be less than originally expected due to such claims. It is expected that the funds to be distributed to PNAC Public Stockholders electing to redeem their PNAC Public Shares shall be distributed promptly after the consummation of the Business Combination.

A PNAC Public Stockholder, together with any affiliate of such holder and any person with whom such holder is acting in concert or as a "group" (as defined under Section 13(d)(3) of the Exchange Act), may not seek to have more than 15% of the aggregate shares redeemed without the consent of PNAC. Under the Existing PNAC Charter, the Business Combination may not be consummated if PNAC (or the entity that succeeds PNAC as a public company) has net tangible assets of less than \$5,000,001 either immediately prior to or upon consummation of the Business Combination after taking into account the redemption for cash of all PNAC Public Shares properly demanded to be redeemed by the PNAC Public Stockholders.

Any request for redemption, once made by a PNAC Public Stockholder, may not be withdrawn once submitted to PNAC unless the Board of Directors of PNAC determines (in its sole discretion) to permit the withdrawal of such redemption request (which it may or may not do in whole or in part).

Any corrected or changed written exercise of redemption rights must be received by VStock, PNAC's transfer agent, prior to the vote taken on the Business Combination Proposal at the Special Meeting. No request for redemption shall be honored unless the holder's share certificates (if any) and other redemption forms (as applicable) have been delivered (either physically or electronically) to VStock, at least two business days prior to the vote at the Special Meeting.

If you exercise your redemption rights, then you shall be exchanging your PNAC Public Shares for cash and shall not be entitled to receive any PubCo Ordinary Shares upon consummation of the Business Combination.

The PNAC Initial Stockholders (including the Sponsors, certain PNAC officers, directors and assignees) have, pursuant to the Insider Letter Agreement (as defined in the prospectus of PNAC filed on May 16, 2022), agreed to, among other things, vote all of their PNAC Founder Shares and PNAC Private Shares in favor of the proposals being presented at the Special Meeting and waive its redemption rights with respect to their PNAC Founder Shares and PNAC Private Shares in connection with the consummation of the Business Combination. As of the date of this proxy statement/prospectus, the PNAC Initial Stockholders own approximately 29.05% of the issued and outstanding shares of PNAC Common Stock.

No compensation of any kind, including finder's and consulting fees, will be paid by PNAC to our Sponsors, officers, directors or any of our or their respective affiliates, for services rendered prior to or in connection with the completion of the Business Combination. However, these individuals will be reimbursed for any out-of-pocket expenses related to identifying and investigating potential target businesses and completing the Business Combination. Certain directors and officers of PNAC are direct or indirect members of the Sponsor, and, following the consummation of the Business Combination, each such director and officer of PNAC is entitled to receive PubCo Ordinary Shares and PubCo Warrants then held by the Sponsors as further described in "*Security Ownership of Certain Beneficial Owners and Management.*" for more information.

On October 25, 2022, PNAC entered into an engagement letter with Prime Number Capital LLC ("PNCPS") and WestPark Capital, Inc. ("WestPark"), the representatives of the underwriters for the initial public offering of PNAC (the "IPO"), to act as the financial advisors to PNAC (the "Financial Advisory Engagement"). In connection with the Financial Advisory Engagement, PNCPS and Westpark will not receive any additional compensation for services rendered under the Financial Advisory Engagement except the deferred underwriting fee in the amount of \$2,257,500 as provided in a certain underwriting agreement for the IPO dated May 12, 2022 among PNAC, PNCPS and Westpark. PNAC also agrees to reimburse PNCPS and WestPark up to \$20,000 for its reasonable out-of-pocket expenses in connection with the performance of their services thereunder. In addition, on the same date, PNAC separately entered into an engagement letter with PNCPS who would, among others, use its reasonable efforts in identifying and introducing potential targets, evaluate potential business combination and assess the proposed structure for business combination and assist in managing the process and other related service (the "Business Combination Advisory Engagement"). On January 31, 2023, PNAC entered into an amendment to the foregoing engagement letter to set forth the compensation for the Business Combination Advisory Engagement. In connection with the Business Combination Advisory Engagement, PNAC shall pay or cause the surviving entities of the Business Combination to pay PNCPS \$500,000 in cash and issue PNCPS 609,756 PubCo Ordinary Shares upon the Closing of the Business Combination. PNAC also agrees to reimburse PNCPS up to \$5,000 for its reasonable out-of-pocket expenses in rendering their services. In addition, on April 30, 2023, PNAC entered into a Placement Agent Agreement with PNCPS, pursuant to which PNCPS shall act as the placement agent for the solicitation and placement of securities of PNAC, in exchange for a placement fee of 7% of the aggregate gross proceeds received by PNAC from the sales of such securities. Further details of these arrangements are set forth in the section entitled "*Business Combination Proposal—Certain Engagements in Connection with the Business Combination and Related Transactions.*"

The Business Combination Agreement is also subject to the satisfaction or waiver of certain other closing conditions as described in the accompanying proxy statement/prospectus. There can be no assurance that the parties to the Business Combination Agreement would waive any such provision of the Business Combination Agreement.

Additionally, the Business Combination may be subject to certain government review, including but not limited to the review by the Committee on Foreign Investment in the United States (CFIUS). CFIUS is an interagency committee authorized to review certain transactions involving foreign investment in the United States by foreign persons in order to determine the effect of such transactions on the national security of the United States. Whether CFIUS has jurisdiction to review an acquisition or investment transaction depends on, among other factors, the nature and structure of the transaction, including the level of beneficial ownership interest and the nature of any information or governance rights involved.

Among PNAC's management, Mr. Dongfeng Wang, PNAC's Chairman and Chief Executive Officer, is located in the U.S. and a U.S. permanent resident, and a Hong Kong citizen. Mr. Weixiong (Jeff) Cheong, PNAC's Chief Operating Officer, is located outside U.S. and a Singapore citizen. Other than Mr. Wang and Mr. Cheong, the rest of our directors and officers are U.S. citizens residing in the U.S. Both Sponsor A, Prime Number Acquisition LLC, which currently holds 25.03% of PNAC's outstanding shares, and Sponsor B, Glorious Capital LLC, which currently holds 2.02% of PNAC's outstanding shares, are owned in part, directly or indirectly, by certain Hong Kong or PRC nationals. As a result, an aggregate of 1,208,541 shares, or 17.46% of PNAC's outstanding shares are held indirectly by non-U.S. persons or persons with foreign citizenship. PNAC is therefore likely considered a "foreign person" under the regulations administered by CFIUS and will continue to be considered as such in the future for so long as the Sponsors have the ability to exercise control over PNAC for purposes of CFIUS's regulations. Therefore, it could be subject to foreign ownership restrictions and/or CFIUS review if noco-noco is considered to be engaged in a regulated industry or which may affect national security.

Moreover, the scope of CFIUS review was expanded by the Foreign Investment Risk Review Modernization Act of 2018 ("FIRRMA"), to include certain non-passive, non-controlling investments in sensitive U.S. businesses and certain acquisitions of real estate even with no underlying U.S. business. FIRRMA's implementing regulations, which became effective on February 13, 2020, expanded the scope of CFIUS's jurisdiction to investments that do not result in control of a U.S. business by a foreign person but afford certain foreign investors certain information or governance rights in a U.S. business that has a nexus to "critical technologies," "critical

infrastructure” and/or “sensitive personal data.” In addition, the implementing regulations also subjects certain categories of investments to mandatory filings. If noco-noco’s business falls within CFIUS’s jurisdiction, PNAC may determine that PNAC is required to make a mandatory filing or that PNAC will submit a voluntary notice to CFIUS, or to proceed with the initial business combination without notifying CFIUS and risk CFIUS intervention, before or after closing the Business Combination. CFIUS may decide to block or delay the Business Combination, impose conditions to mitigate national security concerns with respect to the Business Combination or order us to divest all or a portion of PubCo’s business without first obtaining CFIUS clearance.

As a result of, and upon consummation of the Business Combination, each of PNAC and noco-noco shall become a subsidiary of PubCo, and PubCo shall become a new public company owned by the prior holders of PNAC Common Stock, the prior holders of PNAC Rights, the prior holders of PNAC Warrants, the Sellers, and certain third-party investors of a financing in connection with the Business Combination. PubCo is a holding company incorporated in the Cayman Islands. In addition, noco-noco’s businesses are substantially based in Singapore, with projects and operations in Australia and PNG, and potentially, in Philippines, Indonesia, India, or Thailand in the near future. As a result, PNAC does not expect the Business Combination to result in “control” of a “U.S. business” by a “foreign person.” under the regulations administered by CFIUS. Additionally, it does not expect the business of PNAC to be deemed to have a nexus to “critical technologies,” “covered investment critical infrastructure,” and/or “sensitive personal data” under the regulations administered by CFIUS. Notwithstanding the above, if our determination is not correct, or if the regulations change or are interpreted differently in the future, the Business Combination may be subject to CFIUS review or review by another U.S. governmental entity and ultimately prohibited. Even if it not prohibited, any review by CFIUS or another government entity may have outsized impacts on, among other things, the certainty, timing and feasibility of the Business Combination, which would significantly limit or completely hinder our ability to complete the Business Combination and force PNAC to liquidate and our warrants to expire worthless, preventing the possibility of any price appreciation that may have occurred in our securities following the Business Combination.

The process of government review, whether by the CFIUS or otherwise, could be lengthy and PNAC has limited time to complete the Business Combination. Pursuant to Existing PNAC Charter, we have until July 17, 2023 to consummate the Business Combination (or November 17, 2023). If PNAC cannot complete the Business Combination by November 17, 2023 (assuming full extension) because the review process drags on beyond such timeframe or because the Business Combination is ultimately prohibited by CFIUS or another U.S. government entity, it may be required to liquidate. If PNAC liquidates, its Public Stockholders may only receive \$10.20 per share, and its warrants and rights will expire worthless. This will also cause you to lose the investment opportunity in noco-noco or another target company and the chance of realizing future gains on your investment through any price appreciation in the combined company. For more information, see “*Risk Factors—Risks related to PNAC and the Business Combination-- We may not be able to complete the Business Combination if it is subject to U.S. foreign investment regulations and review by a U.S. government entity such as the Committee on Foreign Investment in the United States (CFIUS), or ultimately prohibited.*”

All PNAC stockholders are cordially invited to attend the Special Meeting. To ensure your representation at the Special Meeting, however, you are urged to complete, sign, date and return the enclosed proxy card as soon as possible by following the instructions provided in this proxy statement/prospectus and on the enclosed proxy card. If you are a stockholder of record of PNAC Common Stock, you may also cast your vote by means of remote communication at the Special Meeting by navigating to [redacted] and entering the control number on your proxy card. If your shares are held in an account at a brokerage firm or bank, you must instruct your broker or bank on how to vote your shares or, if you wish to attend the Special Meeting and vote by means of remote communication you must obtain a proxy from your broker or bank and a control number from [proxy agent].

**Your vote is important regardless of the number of shares you own. Whether or not you plan to attend the Special Meeting, please sign, date, vote and return the enclosed proxy card as soon as possible in the envelope provided to make sure that your shares are represented at the Special Meeting. If your shares are held in “street name” or are in a margin or similar account, you should contact your broker or bank to ensure that votes related to the shares you beneficially own are properly counted. The Business Combination will be consummated only if the Business Combination Proposal and the Governing Documents Proposal are approved at the Special Meeting. Each of the Business Combination Proposal and the Governing Documents Proposal is cross-conditioned on the approval of each other. The Adjournment Proposal is not conditioned upon the approval of any other proposal set forth in this proxy statement/prospectus.**

Thank you for your participation. We look forward to your continued support.

By Order of the Board of Directors

Dongfeng Wang  
Chairman

If you sign, date and return your proxy card without indicating how you wish to vote, your proxy will be voted FOR each of the proposals presented at the Special Meeting. If you fail to return your proxy card or fail to instruct your bank, broker or other nominee how to vote, and do not attend the Special Meeting in person or virtually, the effect will be, among other things, that your shares will not be counted for purposes of determining whether a quorum is present at the Special Meeting and will not be voted. An abstention or broker non-vote will be counted towards the quorum requirement but will not count as a vote cast at the Special Meeting. If you are a stockholder of record and you attend the Special Meeting and wish to vote in person or virtually, you may withdraw your proxy and vote in person. Your attention is directed to the remainder of the proxy statement/prospectus following this notice (including the Annexes and other documents referred to herein) for a more complete description of the proposed Business Combination and related transactions and each of the proposals. You are encouraged to read this proxy statement/prospectus carefully and in its entirety, including the Annexes and other documents referred to herein. If you have any questions or need assistance voting your ordinary shares, please contact [proxy agent] at \_\_\_\_\_ or by emailing \_\_\_\_\_.

**TO EXERCISE YOUR REDEMPTION RIGHTS, YOU MUST DEMAND IN WRITING THAT YOUR PNAC COMMON STOCK BE REDEEMED FOR A PRO RATA PORTION OF THE FUNDS HELD IN THE TRUST ACCOUNT AND TENDER YOUR SHARES TO OUR TRANSFER AGENT AT LEAST TWO BUSINESS DAYS BEFORE THE SCHEDULED DATE OF THE SPECIAL MEETING. IN ORDER TO EXERCISE YOUR REDEMPTION RIGHT, YOU NEED TO IDENTIFY YOURSELF AS A BENEFICIAL HOLDER AND PROVIDE YOUR LEGAL NAME, PHONE NUMBER AND ADDRESS IN YOUR WRITTEN DEMAND. YOU MAY TENDER YOUR SHARES BY EITHER DELIVERING YOUR SHARE CERTIFICATE TO THE TRANSFER AGENT OR BY DELIVERING YOUR SHARES ELECTRONICALLY USING THE DEPOSITORY TRUST COMPANY'S DWAC (DEPOSIT WITHDRAWAL AT CUSTODIAN) SYSTEM. IF THE BUSINESS COMBINATION IS NOT COMPLETED, THEN THESE SHARES SHALL BE RETURNED TO YOU OR YOUR ACCOUNT. IF YOU HOLD THE SHARES IN STREET NAME, YOU NEED TO INSTRUCT THE ACCOUNT EXECUTIVE AT YOUR BROKER, BANK OR OTHER NOMINEE TO WITHDRAW THE SHARES FROM YOUR ACCOUNT IN ORDER TO EXERCISE YOUR REDEMPTION RIGHTS. SEE "SPECIAL MEETING OF PNAC STOCKHOLDERS—REDEMPTION RIGHTS" FOR MORE SPECIFIC INSTRUCTIONS.**

	<b>Page</b>
<a href="#">ADDITIONAL INFORMATION</a>	<a href="#">13</a>
<a href="#">ABOUT THIS PROXY STATEMENT/PROSPECTUS</a>	<a href="#">13</a>
<a href="#">INDUSTRY AND MARKET DATA</a>	<a href="#">13</a>
<a href="#">FREQUENTLY USED TERMS</a>	<a href="#">14</a>
<a href="#">QUESTIONS AND ANSWERS ABOUT THE PROPOSALS</a>	<a href="#">18</a>
<a href="#">SUMMARY OF THE PROXY STATEMENT/PROSPECTUS</a>	<a href="#">33</a>
<a href="#">SELECTED HISTORICAL FINANCIAL DATA OF PNAC</a>	<a href="#">48</a>
<a href="#">SELECTED HISTORICAL FINANCIAL DATA OF NOCO-NOCO</a>	<a href="#">49</a>
<a href="#">SELECTED UNAUDITED PRO FORMA CONDENSED COMBINED FINANCIAL INFORMATION</a>	<a href="#">50</a>
<a href="#">FORWARD-LOOKING STATEMENTS</a>	<a href="#">51</a>
<a href="#">RISK FACTORS</a>	<a href="#">53</a>
<a href="#">SPECIAL MEETING OF PNAC STOCKHOLDERS</a>	<a href="#">106</a>
<a href="#">THE BUSINESS COMBINATION PROPOSAL</a>	<a href="#">110</a>
<a href="#">THE GOVERNING DOCUMENTS PROPOSAL</a>	<a href="#">136</a>
<a href="#">THE ADJOURNMENT PROPOSAL</a>	<a href="#">142</a>
<a href="#">MATERIAL TAX CONSIDERATIONS</a>	<a href="#">143</a>
<a href="#">UNAUDITED PRO FORMA CONDENSED COMBINED FINANCIAL INFORMATION</a>	<a href="#">151</a>
<a href="#">INFORMATION RELATED TO PUBCO</a>	<a href="#">158</a>
<a href="#">INFORMATION RELATED TO PNAC</a>	<a href="#">160</a>
<a href="#">MANAGEMENT'S DISCUSSION AND ANALYSIS OF FINANCIAL CONDITION AND RESULTS OF OPERATION OF PNAC</a>	<a href="#">172</a>
<a href="#">INDUSTRY OVERVIEW RELATING TO NOCO-NOCO'S BUSINESS</a>	<a href="#">177</a>
<a href="#">NOCO-NOCO'S BUSINESS</a>	<a href="#">185</a>
<a href="#">MANAGEMENT'S DISCUSSION AND ANALYSIS OF FINANCIAL CONDITION AND RESULTS OF OPERATIONS OF NOCO-NOCO</a>	<a href="#">205</a>
<a href="#">MANAGEMENT OF PUBCO FOLLOWING THE BUSINESS COMBINATION</a>	<a href="#">214</a>
<a href="#">SECURITY OWNERSHIP OF CERTAIN BENEFICIAL OWNERS AND MANAGEMENT</a>	<a href="#">222</a>
<a href="#">CERTAIN RELATIONSHIPS AND RELATED PERSON TRANSACTIONS</a>	<a href="#">224</a>
<a href="#">DESCRIPTION OF PUBCO SECURITIES</a>	<a href="#">227</a>
<a href="#">COMPARISON OF CORPORATE GOVERNANCE AND SHAREHOLDER RIGHTS</a>	<a href="#">239</a>
<a href="#">SHARES ELIGIBLE FOR FUTURE SALE</a>	<a href="#">245</a>
<a href="#">PRICE RANGE OF SECURITIES AND DIVIDEND INFORMATION</a>	<a href="#">248</a>
<a href="#">ANNUAL MEETING SHAREHOLDER PROPOSALS</a>	<a href="#">248</a>
<a href="#">OTHER SHAREHOLDER COMMUNICATIONS</a>	<a href="#">248</a>
<a href="#">LEGAL MATTERS</a>	<a href="#">250</a>
<a href="#">EXPERTS</a>	<a href="#">250</a>
<a href="#">DELIVERY OF DOCUMENTS TO SHAREHOLDERS</a>	<a href="#">250</a>
<a href="#">WHERE YOU CAN FIND MORE INFORMATION</a>	<a href="#">251</a>
<a href="#">INCORPORATION OF CERTAIN INFORMATION BY REFERENCE</a>	<a href="#">228</a>
<a href="#">INDEX OF FINANCIAL STATEMENTS</a>	<a href="#">F-1</a>
<b>ANNEXES</b>	
<a href="#">Annex A: Business Combination Agreement</a>	
<a href="#">Annex B: Form of Memorandum and Articles of Association of PubCo</a>	

## ADDITIONAL INFORMATION

You may request copies of this proxy statement/prospectus and any other publicly available information concerning PNAC, without charge, by written request to [proxy agent] our proxy solicitor, by calling +1 \_\_\_\_\_, or by emailing \_\_\_\_\_, or from the SEC through the SEC website at <http://www.sec.gov>.

In order for PNAC stockholders to receive timely delivery of the documents in advance of the Special Meeting of PNAC to be held on \_\_\_\_\_, 2023 you must request the information no later than five business days prior to the date of the Special Meeting, by \_\_\_\_\_, 2023.

## ABOUT THIS PROXY STATEMENT/PROSPECTUS

This document, which forms part of a registration statement on Form F-4 filed with the U.S. Securities and Exchange Commission, or the “SEC,” by PubCo, constitutes a prospectus of PubCo under Section 5 of the U.S. Securities Act of 1933, as amended, or the “Securities Act,” with respect to the PubCo Ordinary Shares to be issued to PNAC stockholders and the PubCo Ordinary Shares to be issued to certain noco-noco shareholders, if the Business Combination described herein is consummated. This document also constitutes a notice of meeting and a proxy statement under Section 14(a) of the U.S. Securities Exchange Act of 1934, as amended (the “Exchange Act”), with respect to the Special Meeting of PNAC stockholders at which PNAC stockholders shall be asked to consider and vote upon proposals to approve the Business Combination Proposal and the Governing Documents Proposal (each as defined herein) and to adjourn the meeting, if necessary, to permit further solicitation of proxies because there are not sufficient votes to adopt the Business Combination Proposal or the Governing Documents Proposal.

References to “U.S. Dollars” and “\$” in this proxy statement/prospectus are to United States dollars, the legal currency of the United States. Certain monetary amounts, percentages and other figures included in this proxy statement/prospectus have been subject to rounding adjustments. Accordingly, figures shown as totals in certain tables or charts may not be the arithmetic aggregation of the figures that precede them, and figures expressed as percentages in the text may not total 100% or, as applicable, when aggregated may not be the arithmetic aggregation of the percentages that precede them. In particular, in certain cases, percentage changes are based on a comparison of the actual values recorded in the relevant financial statements and not rounded values shown in this proxy statement/prospectus.

## INDUSTRY AND MARKET DATA

This proxy statement/prospectus contains industry data, information and statistics regarding the markets in which noco-noco operates as well as publicly available information, industry and general publications and research and studies conducted by third parties. This information is supplemented where necessary with noco-noco’s own internal estimates and information obtained from other sources, taking into account publicly available information about other industry participants and noco-noco management’s judgment where information is not publicly available. This information appears in “*Summary of the Proxy Statement/Prospectus*,” “*noco-noco’s Business*” and “*noco-noco’s Management’s Discussion and Analysis of Financial Condition and Results of Operation*,” and other sections of this proxy statement/prospectus.

Forecasts and other forward-looking information obtained from these sources are subject to the same qualifications and uncertainties as the other forward-looking statements in this proxy statement/prospectus. These forecasts and forward-looking information are subject to uncertainty and risk due to a variety of factors, including those described under “*Risk Factors*”, particular “*Risk Factors—Risks related to noco-noco’s Business and Industry--Our operating and financial results forecast relies in large part upon assumptions and analyses developed by us. If these assumptions or analyses prove to be incorrect, our actual operating results may be materially different from our forecasted results.*” and “*Risk Factors-- Risks related to noco-noco’s Business and Industry-- If the estimates and assumptions we use to determine the size of our total addressable market are inaccurate, our future growth rate may be affected and our business would be harmed.*” These and other factors could cause results to differ materially from those expressed in any forecasts or estimates.



## FREQUENTLY USED TERMS

### *Key Business and Business Combination Related Terms*

Unless otherwise stated or unless the context otherwise requires in this document:

“3DOM Alliance” means 3DOM Alliance Inc., a company incorporated under the laws of Japan, which is the majority shareholder of noco-noco;

“ACCUs” means Australian Carbon Credit Units, the national carbon credits issued by Australian regulators which can be obtained through establishing ERF projects;

“ACRA” means the Singapore Accounting and Corporate Regulatory Authority;

“Amended PubCo Charter” means the amended and restated articles and memorandum of PubCo to be approved and adopted upon the Merger Closing;

“Available PNAC Cash” means an amount (that is not generated from any borrowing) equal to the sum of (i) the amount of cash available in the Trust Account following the Special Meeting, after deducting the amount required to satisfy the redemption by the PNAC Public Stockholders but prior to the payment of any deferred underwriting commissions being held in the Trust Account and the payment of any noco-noco Transaction Expenses or PNAC Transaction Expenses, plus (ii) the proceeds of Transaction Financing;

“BEV” means battery electric vehicles, vehicles that exclusively use chemical energy stored in rechargeable battery packs; and “EV” means electric vehicles;

“Business Combination” means the Merger, the Share Exchange and the other transactions contemplated by the Business Combination Agreement;

“Business Combination Agreement” means the business combination agreement, dated December 29, 2022 (as may be amended, supplemented, or otherwise modified from time to time), by and among PubCo, PNAC, Merger Sub, New SubCo, noco-noco and certain shareholders of noco-noco;

“Business Combination Transactions” means, collectively, the Merger, the Share Exchange and each of the other transactions contemplated by the Business Combination Agreement, the Lock-up Agreement, the Registration Rights Agreements, the Warrant Assumption Agreement, the Certificate of Merger, the PubCo ESOP, the Amended and Restated PubCo Charter, the BCA Joinder and any other related agreements, documents or certificates entered into or delivered pursuant thereto;

“CAGR” means compound annual growth rate;

“Cayman Islands Companies Act” means the Companies Act (As Revised) of the Cayman Islands;

“CER” means Clean Energy Regulator, a regulatory body established by the Australian government by virtue of the Clean Energy Regulator Act 2011 to measure, reduce and offset Australia’s carbon emissions, including managing carbon credits;

“Closing” means the closing of the Business Combination;

“Closing Date” means the date of the Closing;

“DGCL” means the General Corporation Law of the State of Delaware;

“ERF” means Emissions Reduction Fund, one of the schemes regulated by the CER;

“ESS” means energy storage system, a device or group of devices assembled together, capable of storing energy in order to supply electrical energy at a later time;

“Existing PNAC Charter” means the amended and restated certificate of incorporation of PNAC dated May 10, 2022, as amended by the certificate of amendment dated May 17, 2023;

“Existing Warrant Agreement” means the warrant agreement, dated May 12, 2022, by and between PNAC and VStock;

“Final Redemption Date” means May 17, 2023 (or November 17, 2023 if PNAC extends the period of time to consummate the Business Combination for up to six times by an additional one-month period each time);

“Frost & Sullivan” means Frost & Sullivan Limited, a third-party research and consulting firm to noco-noco;

“Governmental Authority” means any federal, state, provincial, municipal, local or foreign government, governmental authority, taxing, regulatory or administrative agency, governmental commission, department, board, bureau, agency or instrumentality, court or tribunal;

“JOBS Act” means the Jumpstart Our Business Startups Act of 2012;

“LOI” means letter of intent;

“Merger” means the merger between PNAC and Merger Sub, with PNAC being the surviving company and a wholly-owned subsidiary of PubCo;

“Merger Closing” means the closing of the Merger;

“Merger Effective Time” means the effective time of the Merger, being the time of the Certificate of Merger (as defined in the Business Combination Agreement) being accepted by the Secretary of State of the State of Delaware, or such later time as may be specified in the Certificate of Merger;

“Merger Sub” means Prime Number Merger Sub Inc., a Delaware corporation;

“MOU” means memorandum of understanding;

“Nasdaq” means the Nasdaq Stock Market;

“New SubCo” means Prime Number New Sub Pte. Ltd., a Singapore private company limited by shares;

“noco-noco” means NOCO-NOCO PTE. LTD., a Singapore private company limited by shares, or as the context requires, NOCO-NOCO PTE. LTD. and its subsidiaries and consolidated affiliated entities;

“noco-noco Insider” means a holder of the ordinary shares of noco-noco who (i) is a director or executive officer of noco-noco or (ii) owns in the aggregate at least five percent (5%) of the issued and outstanding share capital of noco-noco prior to the Share Exchange;

“noco-noco Transaction Expenses” means any out-of-pocket fees and expenses payable by (a) noco-noco or any of its subsidiaries or affiliates (whether or not billed or accrued for) as a result of or in connection with the negotiation, documentation and consummation of the Business Combination, including (i) all fees, costs, expenses, brokerage fees, commissions, finders’ fees and disbursements of financial advisors, investment banks, data room administrators, attorneys, accountants and other advisors and service providers, including consultants and public relations firms, (ii) any and all filing fees payable by noco-noco or any of its subsidiaries or affiliates to the Governmental Authorities in connection with the Business Combination, and (b) the stamp duty payable by the Sellers in connection with the Share Exchange;

“noco-noco Shares” means the outstanding ordinary shares of noco-noco;

“noco-noco Valuation” means \$1,350,000,000;

“Interim Period” means the period from the signing date of the Business Combination Agreement through the earlier of the Closing or valid termination of the Business Combination Agreement.

“OEM” means original equipment manufacturer;

“PNAC” means Prime Number Acquisition I Corp., a Delaware corporation;

“PNAC Board” means PNAC’s board of directors.

“PNAC Class A Common Stock” means the shares of Class A Common Stock of PNAC, having a par value of \$0.0001 each;

“PNAC Class B Common Stock” means the shares of Class B Common Stock of PNAC, having a par value of \$0.0001 each;

“PNAC Common Stock” means PNAC Class A Common Stock and PNAC Class B Common Stock; and as of the date hereof, PNAC does not have any shares of PNAC Class B Common Stock issued and outstanding;

“PNAC Founder Shares” means 1,612,500 shares of PNAC Class A Common Stock that the Sponsors purchased from PNAC pursuant to certain securities purchase agreements dated April 7, 2021, a portion of which were transferred by Sponsor A to PNAC officers, directors and other assignees pursuant to a certain securities assignment agreement dated May 12, 2022;

“PNAC Initial Stockholders” means the existing stockholders of PNAC Founder Shares and PNAC Private Shares, or in other words, the Sponsor A, Sponsor B, directors and officers of PNAC, and their affiliates;

“PNAC IPO” means the initial public offering of PNAC that was consummated on May 17, 2022;

“PNAC Private Shares” means 398,892 shares of PNAC Class A Common Stock that the Sponsors acquired from PNAC pursuant to a certain private placement shares purchase agreement dated May 12, 2022;

“PNAC Public Shares” means 6,450,000 shares of PNAC Class A Common Stock that PNAC sold in its initial public offering including shares issued upon the partial exercise of the underwriters’ over-allotment option, 1,537,701 shares of which were tendered for redemption prior to a PNAC special stockholder meeting on May 15, 2022 and were cancelled on May 22, 2023;

“PNAC Rights” means rights of PNAC sold as part of the PNAC Units in the PNAC IPO (whether they are purchased in the PNAC IPO or thereafter in the open market);

“PNAC Public Stockholders” means the holders of the PNAC Public Shares;

“PNAC Transaction Expenses” means any out-of-pocket fees and expenses actually payable by PNAC, PubCo, New SubCo, Merger Sub, any of the Sponsors or its affiliates (whether or not billed or accrued for) as a result of or in connection with PNAC’s negotiation, documentation and consummation of the Business Combination, including (a) all fees (excluding amounts due to the underwriters of PNAC IPO with respect to deferred underwriting commissions), costs, expenses, brokerage fees, commissions, finders’ fees and disbursements of financial advisors, investment banks, data room administrators, attorneys, accountants and other advisors and service providers, including consultants and public relations firms, and (b) any and all filing fees to the Governmental Authorities in connection with the Business Combination;

“PNAC Units” means units of PNAC issued in connection with PNAC IPO, each unit consisting of one share of PNAC Class A Common Stock, one-half of PNAC Warrant, and one PNAC Right;

“PNAC Warrants” means redeemable warrants of PNAC sold as part of the PNAC Units in the PNAC IPO (whether they are purchased in the PNAC IPO or thereafter in the open market);

“PNG” means Papua New Guinea;

“PubCo” means prior to the Closing, Prime Number Holding Limited, an exempted company limited by shares incorporated under the laws of the Cayman Islands; and upon and following the Closing, noco-noco Inc., an exempted company limited by shares incorporated under the laws of the Cayman Islands;

“PubCo Ordinary Shares” means the ordinary shares of PubCo, having a par value of \$0.0001 each;

“PubCo Per Share Price” means the price per PubCo Ordinary Share that equal to the redemption price of each share of PNAC public share in connection with the Business Combination;

“R&D” means research and development;

“Record Date” means ;

“Registration Rights Agreement” means the registration rights agreement to be entered between PubCo, the Sponsors and certain shareholders of noco-noco pursuant to the Business Combination Agreement upon closing;

“RSU” means restricted stock units;

“SEC” means the U.S. Securities and Exchange Commission;

“Sellers” means the shareholders of noco-noco (immediately prior to the Share Exchange) participating in the Share Exchange.

“shareholders” or “stockholders” means the holders of shares or stocks of a company;

“Share Exchange” means the transaction pursuant to which New SubCo will acquire issued and outstanding shares of noco-noco from the Sellers, in exchange, PubCo will issue to the Sellers the PubCo Ordinary Shares;

“Share Exchange Closing” means the closing of the Share Exchange;

“Singapore Dollars” and “S\$” means Singapore dollars, the legal currency of Singapore;

“Special Meeting” means an Special meeting of shareholders of PNAC to be held at \_\_\_\_\_ AM Eastern time, on \_\_\_\_\_, 2023 virtually at \_\_\_\_\_ ;

“Sponsor A” means Prime Number Acquisition LLC, a limited liability company incorporated under the laws of the State of Delaware;

“Sponsor B” means Glorious Capital LLC, a limited liability company incorporated under the laws of the State of Delaware;

“Sponsors” means, collectively, Sponsor A and Sponsor B;

“Transaction Financing” means equity financing that, pursuant to the Business Combination Agreement, PubCo, PNAC and the New SubCo shall use reasonable best efforts to obtain, on the terms mutually agreed to by noco-noco and PNAC, in an amount that is at least \$20,000,000 prior to or upon the Share Exchange Closing;

“Trust Account” means the Trust Account maintained by Wilmington Trust, N.A., acting as trustee, established for the benefit of PNAC Public Stockholders in connection with the PNAC IPO;

“VStock” means VStock Transfer, LLC, the transfer agent of PNAC Class A Common Stock;

“Warrant Assumption Agreement” means the warrant assumption agreement to be entered into by and among PubCo, PNAC and VStock prior to the Merger Effective Time in relation to the assignment by PNAC and assumption by PubCo of the Existing Warrant Agreement;

“U.S. Dollars,” “US\$” and “\$” means United States dollars, the legal currency of the United States;

“U.S. GAAP” means United States generally accepted accounting principles;

“Working Capital Loans” means loans of up to \$3,000,000 made by the Sponsors, directors, officers or affiliates of PNAC to finance transaction costs in connection with an intended initial business combination; and

“Working Capital Shares” means the shares of PNAC Class A Common Stock issuable upon the conversion of the Working Capital Loans, at a price of \$10.00 per share at the option of the lender.

## QUESTIONS AND ANSWERS ABOUT THE PROPOSALS

The questions and answers below highlight only selected information from this document and only briefly address some commonly asked questions about the proposals to be presented at the Special Meeting, including with respect to the proposed Business Combination. The following questions and answers do not include all the information that is important to PNAC stockholders. PNAC stockholders should read this proxy statement/prospectus, including the Annexes and the other documents referred to herein, carefully and in their entirety to fully understand the proposed Business Combination and the voting procedures for the Special Meeting, which will be held virtually via live webcast at

### **Q: Why am I receiving this proxy statement/ prospectus?**

A: PNAC stockholders are being asked to consider and vote upon a proposal to approve and adopt the Business Combination and certain related proposals.

PNAC, noco-noco, PubCo and other parties have agreed to the Business Combination under the terms of the Business Combination Agreement that is described in this proxy statement/prospectus. The Business Combination Agreement provides for, among other things, (i) the merger of Merger Sub with and into PNAC, with PNAC being the surviving company and a wholly-owned subsidiary of PubCo, and each of the current security holders of PNAC receiving securities of PubCo, and (ii) the acquisition by New SubCo of all or majority of the issued and outstanding shares of noco-noco from the shareholders of noco-noco, in exchange for PubCo to issue to the shareholders of noco-noco the PubCo Ordinary Shares. This proxy statement/prospectus and its annexes contain important information about the proposed Business Combination and the other matters to be acted upon at the Special Meeting. You should read this proxy statement/prospectus and its annexes carefully and in their entirety.

### **Q: What proposals are shareholders of PNAC being asked to vote upon?**

A: At the Special Meeting, PNAC is asking PNAC stockholders to consider and vote upon the following proposals:

- Business Combination Proposal—To vote to adopt the Business Combination Agreement and approve the transactions (and related transaction documents) contemplated thereby. See the section entitled “The Business Combination Proposal.”
- Governing Documents Proposal—To vote to approve an amended & restated memorandum of associations of PubCo (“Amended PubCo Charter”). See the section entitled “The Governing Documents Proposal.”
- Adjournment Proposal—To consider and vote upon a proposal to adjourn the meeting to a later date or dates to permit further solicitation and voting of proxies if, based upon the tabulated vote at the time of the Special Meeting, PNAC would not have been authorized to consummate the Business Combination. See the section entitled “The Adjournment Proposal.”

PNAC shall hold the Special Meeting for PNAC stockholders to consider and vote upon these proposals. This proxy statement/prospectus contains important information about the proposed Business Combination and the other matters to be acted upon at the Special Meeting. PNAC stockholders should read it carefully and in its entirety.

The vote of PNAC stockholders is important. PNAC stockholders are encouraged to submit their completed proxy card as soon as possible after carefully reviewing this proxy statement/prospectus.

### **Q: Are the proposals conditioned on one another?**

A: Yes. Each of the Business Combination Proposal and the Governing Documents Proposal is cross-conditioned on the approval of each other. The Adjournment Proposal is not conditioned upon the approval of any other proposal.

The vote of PNAC stockholders is important. PNAC stockholders are encouraged to submit their completed proxy card as soon as possible after carefully reviewing this proxy statement/prospectus.

**Q: Why is PNAC proposing the Business Combination?**

A: PNAC was incorporated to consummate capital stock exchange, asset acquisition, stock purchase, reorganization or similar business combination with one or more businesses.

noco-noco is a development-stage manufacturer of carbon-zero electric vehicle battery technologies. Through the research and development of multilayer battery separator and by providing sustainable mobility services for people and goods, noco-noco aims to address the need for energy to customers driven to carbon-zero.

Based on its due diligence investigations of noco-noco and the industries in which it operates, including the financial and other information provided by noco-noco in the course of PNAC's due diligence investigations, the PNAC Board believes that the Business Combination with noco-noco is in the best interests of PNAC and presents an opportunity to increase stockholder equity value. However, there can be no assurances of this. Although the PNAC Board believes that the Business Combination with noco-noco presents a unique business combination opportunity and is in the best interests of PNAC, the PNAC Board did consider certain potentially material negative factors in arriving at that conclusion. See *"The Business Combination Proposal—PNAC Board's Reasons for the Approval of the Business Combination"* for a discussion of the factors considered by the PNAC Board in making its decision.

**Q: Did the PNAC Board obtain a third-party valuation or fairness opinion in determining whether or not to proceed with the Business Combination?**

A: No. The PNAC Board did not obtain a third-party valuation or fairness opinion in connection with its determination to approve the Business Combination. Accordingly, investors will be relying solely on the judgment of the PNAC Board in valuing noco-noco's business and assume the risk that the PNAC Board may not have properly valued such business.

**Q: What is expected to happen in the Business Combination?**

A: In accordance with the terms and subject to the conditions of the Business Combination Agreement, the parties to the Business Combination Agreement have agreed that, in connection with the Closing, the parties shall undertake a series of transactions pursuant to which (i) Merger Sub shall merge with and into PNAC, with PNAC being the surviving company and a wholly-owned subsidiary of PubCo and (ii) following the Merger, New SubCo shall acquire all of the issued and outstanding shares of noco-noco from the shareholders of noco-noco, or the Sellers, in exchange for PubCo to issue to the Sellers PubCo Ordinary Shares. The merger described in (i) is referred to as the "Merger", and the share exchange described in (ii) is referred to as the "Share Exchange." The Merger, the Share Exchange and the other transactions contemplated by the Business Combination Agreement are referred to as the "Business Combination."

Upon the consummation of the Business Combination, (i) each PNAC unit ("PNAC Unit") issued and outstanding immediately prior to the effective time of the Merger shall be automatically detached and the holder thereof shall be deemed to hold one share of PNAC Class A Common Stock (defined below), one-half of PNAC Warrant (defined below), and one PNAC Right (defined below); (ii) each share of PNAC Class A common stock, par value \$0.0001 per share ("PNAC Class A Common Stock") issued and outstanding immediately prior to the effective time of the Merger (as defined herein) shall be canceled in exchange for the right to receive one PubCo Ordinary Share, (iii) each PNAC warrant ("PNAC Warrant") outstanding immediately prior to the effective time of the Merger shall cease to be a warrant with respect to PNAC Common Stock and shall be assumed by PubCo and converted into a warrant of PubCo to purchase one PubCo Ordinary Share, subject to substantially the same terms and conditions prior to the effective time of the Merger; and (iv) each PNAC Right ("PNAC Right") outstanding immediately prior to the effective time of the Merger shall cease to be a right with respect to PNAC Common Stock and be converted into a right to receive one-eighth (1/8) of one PubCo Ordinary Share, subject to substantially the same terms and conditions prior to the effective time of the Merger.

In addition, pursuant to the Business Combination Agreement, upon the consummation of the Business Combination (i) New SubCo shall acquire all of the issued and outstanding shares of noco-noco (“noco-noco Shares”) from the Sellers, (ii) in exchange, each Seller shall receive such number of a newly issued PubCo Ordinary Shares that is equal to the product of (a) the quotient of (i) \$1,350,000,000 (the “noco-noco Valuation”), divided by (ii) the price per PubCo Ordinary Share that equals to the redemption price of each share of PNAC Class A Common Stock in connection with the Business Combination (the “PubCo Per Share Price”), multiplied by (b) such Seller’s Pro Rata Portion as set out in the Allocation Schedule of the Business Combination Agreement. Lastly, pursuant to corporate actions that PubCo shall take prior to the effective time of the Merger, PubCo shall issue 806,250 PubCo Ordinary Shares to such holders of the PNAC rights, with each PNAC right converted into a right to receive one-eighth (1/8) of one PubCo Ordinary Share upon the effective time of the Merger.

For more information on the Merger and the Share Exchange, see the sections titled “*The Business Combination Proposal*,” “*The Business Combination Proposal—General Description of the Business Combination Transactions—The Merger*” and “*The Business Combination Proposal—General Description of the Business Combination Transactions—The Share Exchange*.”

**Q: Is there any financing in connection with the Business Combination?**

A: As provided in the Business Combination Agreement, PubCo, PNAC and the New SubCo shall use reasonable best efforts to obtain equity financing (the “Transaction Financing”) on the terms mutually agreed to by noco-noco and PNAC, in an amount that is at least \$20,000,000 prior to or upon the Share Exchange Closing. We do not expect that PNAC’s Sponsors, directors, officers and their affiliates will participate in the Transaction Financing.

**Q: What shall be the relative equity stakes of PNAC stockholders, and the Sellers in PubCo upon completion of the Business Combination?**

A: Upon consummation of the Business Combination, PubCo shall become a new public company and each of noco-noco and PNAC shall be a subsidiary of PubCo. The former security holders of PNAC and noco-noco shall all become security holders of PubCo.

The equity stake held by holders of non-redeeming PNAC Public Stockholders, the Sellers, and the PNAC Initial Stockholders in PubCo immediately following consummation of the Business Combination will depend on the number of redemptions from the Trust Account by PNAC Public Stockholders at the Closing as well as various other factors, as described in the assumptions set forth below. Approximate equity stakes for each of these stockholder groups upon consummation of the Business Combination and the Transaction Financing, and their corresponding approximate collective voting power in PubCo, are set forth in the table below in respect of three redemption scenarios: (1) “Scenario A,” in which there are no redemptions of PNAC Public Shares; (2) “Scenario B,” in which 25% of the PNAC Public Shares as of the date of this proxy statement/prospectus are redeemed; (3) “Scenario C,” in which 75% of the PNAC Public Shares as of the date of this proxy statement/prospectus are redeemed; and (4) “Scenario D,” in which there are maximum redemptions from the Trust Account. For further information on what constitutes a “maximum redemptions” scenario, please see the section of this proxy statement/prospectus entitled “*Unaudited Pro Forma Condensed Combined Financial Information*.” All else being equal, if any PNAC Public Stockholders exercise their redemption rights, then the percentage of PubCo Ordinary Shares held collectively by all non-redeeming PNAC Public Stockholders and the PNAC Initial Stockholders will decrease and the percentage of PubCo Ordinary Shares held collectively by the investors in the Transaction Financing, the Sellers, will increase, in each case, relative to the percentage held if no PNAC Public Shares are redeemed.

PNAC consummated its initial public offering on May 17, 2022, with 6,450,000 shares of PNAC Common Stock sold. On May 22, 2023, as a result of redemption requests by PNAC Public Stockholders in connection with a PNAC special stockholder meeting, 1,537,701 PNAC Public Shares were cancelled, resulting in 4,912,299 PNAC Public Shares issued and outstanding as the date of this proxy statement/prospectus. The table set forth below also states the anticipated pro forma equity value of PubCo for each of the scenarios described above. These pro forma equity values reflect a PubCo Per Share Price of \$10.34 based on the estimated redemption price of \$10.34 per share as of December 31, 2022 in accordance with the trust asset value of \$66,718,520 as of December 31, 2022. The PubCo Per Share Price is the price per share negotiated with noco-noco and set forth in the Business Combination Agreement for certain PubCo Ordinary Shares to be issued to the Sellers (assuming that all shareholders of noco-noco participating in the Share Exchange, being approximately 130,560,928 PubCo Ordinary Shares, or \$1,350,000,000 in noco-noco Valuation, based on the redemption price of \$10.34 per share as of December 31, 2022). The number of PNAC Public Shares redeemed by PNAC Public Stockholders with cash from the Trust Account at the Merger Closing is not, all else being equal, expected to materially affect the equity value per share of PNAC Public Shares held by non-redeeming PNAC Public Stockholders as at the time immediately following the Closing, as each redemption will result in (x) the cancellation of one PNAC Public Share, and (y) the payment of approximately \$10.34 per share to the redeeming Public Stockholder (given that, based on funds in the Trust Account of \$66,718,520 as of December 31, 2022, the estimated per share redemption price would have been approximately \$10.34 per share) and, accordingly, such funds will not be available to the Combined Company or reflected in its financial statements following the Closing. You should note, however, that the level of redemptions of PNAC Public Shares from our Trust Account may affect the market price for PubCo Ordinary Shares following the Closing in ways which we cannot predict. For further information, please refer to the section of this proxy statement/prospectus entitled "Risk Factors—Risks Related to Redemption of PNAC Common Stock—There is no guarantee that a shareholder's decision whether to redeem its shares for a pro rata portion of the Trust Account will put the shareholder in a better future economic position."

Holders of PubCo Ordinary Shares	Scenario A-No Redemption (2)		Scenario B-25% Redemption(3)		Scenario C-75% Redemption(4)		Scenario D-Maximum Redemption(5)	
	No. of Shares	Voting Power(6)	No. of Shares	Voting Power(6)	No. of Shares	Voting Power(6)	No. of Shares	Voting Power(6)
PNAC Public Stockholders (1)	5,718,549	4.12%	4,490,474	3.26%	2,034,325	1.50%	806,250	0.60%
PNAC Initial Stockholders(7)	2,011,392	1.45%	2,011,392	1.46%	2,011,392	1.49%	2,011,392	1.50%
The Sellers(8)	130,560,928	94.00%	130,560,928	94.83%	130,560,928	96.56%	130,560,928	97.44%
PNCPS compensation shares (9)	609,756	0.44%	609,756	0.44%	609,756	0.45%	609,756	0.46%
<b>Pro Forma PubCo Ordinary Shares at Closing (10)</b>	<b>\$ 138,900,625</b>	<b>100%</b>	<b>137,672,551</b>	<b>100%</b>	<b>135,216,401</b>	<b>100.00%</b>	<b>133,988,326</b>	<b>100.00%</b>
Pro Forma Equity Value								
Pro Forma Book Value								
Total Pro Forma Book Value								
Pro Forma Book Value Per Share								

- (1). As of the date of this proxy statement/prospectus, there are 4,912,299 PNAC Public Shares issued and outstanding that are subject to redemption.
- (2). The numbers set forth in this column assume no PNAC Public Shares are redeemed and 806,250 PubCo Ordinary Shares are issued in exchange for PNAC rights.
- (3). The numbers set forth in this column assume that 1,228,075 PNAC Public Shares, or approximately 25% of 4,912,299 PNAC Public Shares are redeemed at \$10.34 per share and 806,250 PubCo Ordinary Shares are issued in exchange for PNAC rights.
- (4). The numbers set forth in this column assume that 3,684,224 PNAC Public Shares, or approximately 75% of 4,912,299 PNAC Public Shares are redeemed at \$10.34 per share and 806,250 PubCo Ordinary Shares are issued in exchange for PNAC rights.
- (5). The numbers set forth in this column assume that 806,250 PubCo Ordinary Shares are issued in exchange for PNAC rights.
- (6). PNAC Initial Stockholders' equity interests following the Business Combination include PubCo Ordinary Shares in exchange for 1,612,500 founder shares of PNAC and 398,892 private placement shares of PNAC.
- (7). All voting power percentage in this table are approximate and have been rounded to two decimal places.
- (8). Assumes that 100% issued and outstanding shares of Noco-Noco are exchanged for newly issued PubCo Ordinary Shares at \$10.34 per share
- (9). According to the advisory agreement b/t PNCPS and PNAC entered in October 2022 (as amended), PNCPS will be entitled to compensation of 0.5% of valuation of target (\$500,000 payable in cash and remainder payable in shares at the redemption price)
- (10). Excluding effect of any "potential sources of dilution" as set forth in the table, which are subject to certain conditions being satisfied, as set forth in this section of this proxy statement/prospectus entitled "Proposal 1: The Business Combination Proposal-Summary of the Business Combination Agreement."

PNAC stockholders will experience additional dilution to the extent PubCo issues additional shares after the Closing. The table below shows possible sources of dilution and the extent of such dilution that non-redeeming PNAC Public Stockholder could experience in connection with the Closing of the Business Combination. In an effort to illustrate the extent of such dilution, the table below includes (i) the issuance of up to 300,000 Working Capital Shares to the Sponsors or their affiliates or designees, assuming the holders of working capital promissory notes select to convert the working capital promissory notes into Working Capital Shares, (ii) the PubCo Ordinary Shares that will be reserved for issuance under the PubCo Share Incentive Plan (the "PubCo Incentive Plan"), which will initially be equal to 5% of the outstanding PubCo Ordinary Shares as of the Closing, and (iii) up to 3,225,000 PubCo Ordinary Shares underlying PubCo warrants.

Under PubCo Incentive Plan, the maximum number of PubCo Ordinary Shares that may be issued under the PubCo Incentive Plan from time to time is five percent (5%) of the fully diluted share capital of PubCo as of the date of determination. The maximum aggregate number of PubCo Ordinary Shares which may be subject to awards under the PubCo Incentive Plan initially shall be an aggregate number equal to [6,875,666]. The aggregate number of PubCo Ordinary Shares reserved for awards under the PubCo Incentive Plan will automatically increase on July 1 of each year, for a period of not more than ten (10) years, commencing on July 1 of the year following the year in which the effective date occurs and ending on (and including) July 1, 2033, in an amount equal to five percent (5%) of the total number of PubCo Ordinary Shares outstanding on June 30 of the preceding calendar year. Notwithstanding the foregoing, our board may act prior to July 1 of a given year to provide that there will be no July 1 increase for such year or that the increase for such year will be a lesser number of PubCo Ordinary Shares than provided in the PubCo Incentive Plan. For more information, see the section in this proxy statement/prospectus entitled "Management of PubCo Following the Business Combination—Share Incentive Plan."

In addition, the Sponsors, directors and officers may loan PNAC fund to support the operation of PNAC and pay for fees and expenses to consummate the Business Combination, or to extend the time that PNAC needs to complete the Business Combination. Up to \$3,000,000 of such working capital loans and extension loans may be convertible into working capital shares, at a price of \$10.00 per share at the option of the lender. Such working capital shares would be identical to the private shares sold in the private placement.

Holders of PubCo Ordinary Shares	Scenario A-No Redemption (2)		Scenario B-25% Redemption(3)		Scenario C-75% Redemption(4)		Scenario D-Maximum Redemption(5)	
	No. of Shares	Voting Power(6)	No. of Shares	Voting Power(6)	No. of Shares	Voting Power(6)	No. of Shares	Voting Power(6)
PNAC Public Stockholders (1)	5,718,549	3.82%	4,490,474	3.03%	2,034,325	1.40%	806,250	0.56%
PNAC Initial Stockholders (7)	2,011,392	1.34%	2,011,392	1.36%	2,011,392	1.38%	2,011,392	1.39%
The Sellers (8)	130,560,928	87.30%	130,560,928	88.06%	130,560,928	89.62%	130,560,928	90.42%
PNCPS compensation shares (9)	609,756	0.41%	609,756	0.41%	609,756	0.42%	609,756	0.42%
Shares underlying PubCo warrants (10)	3,225,000	2.16%	3,225,000	2.18%	3,225,000	2.21%	3,225,000	2.23%
Working Capital Shares (11)	300,000	0.20%	300,000	0.20%	300,000	0.21%	300,000	0.21%
Shares available under the Incentive Plan (12)	7,121,281	4.76%	7,059,878	4.76%	6,937,070	4.76%	6,875,666	4.76%
<b>Total</b>	<b>149,546,907</b>	<b>100.00%</b>	<b>148,257,428</b>	<b>100.00%</b>	<b>145,678,471</b>	<b>100.00%</b>	<b>144,388,993</b>	<b>100.00%</b>

- (1). As of the date of this proxy statement/prospectus, there are 4,912,299 PNAC Public Shares issued and outstanding that are subject to redemption.
- (2). The numbers set forth in this column assume no PNAC Public Shares are redeemed and 806,250 PubCo Ordinary Shares are issued in exchange for PNAC rights.
- (3). The numbers set forth in this column assume that 1,228,075 PNAC Public Shares, or approximately 25% of 4,912,299 PNAC Public Shares are redeemed at \$10.34 per share and 806,250 PubCo Ordinary Shares are issued in exchange for PNAC rights.
- (4). The numbers set forth in this column assume that 3,684,224 PNAC Public Shares, or approximately 75% of 4,912,299 PNAC Public Shares are redeemed at \$10.34 per share and 806,250 PubCo Ordinary Shares are issued in exchange for PNAC rights.
- (5). The numbers set forth in this column assume that 806,250 PubCo Ordinary Shares are issued in exchange for PNAC rights.
- (6). PNAC Initial Stockholders' equity interests following the Business Combination include PubCo Ordinary Shares in exchange for 1,612,500 founder shares of PNAC and 398,892 private placement shares of PNAC.
- (7). All voting power percentage in this table are approximate and have been rounded to two decimal places.
- (8). Assumes that 100% issued and outstanding shares of Noco-Noco are exchanged for newly issued PubCo Ordinary Shares at \$10.34 per share
- (9). According to the advisory agreement b/t PNCPS and PNAC entered in October 2022 (as amended), PNCPS will be entitled to compensation of 0.5% of valuation of target (\$500,000 payable in cash and remainder payable in shares at the redemption price)
- (10). The numbers represent to PubCo Ordinary Shares issuable upon the exercise of 3,225,000 PubCo warrants.



- (11). Pursuant to the IPO prospectus of PNAC, up to \$3,000,000 working capital loan and extension loan to be provided by the sponsor, its affiliates or designees may be convert into PNAC shares at \$10.00 per share at the option of the lender.
- (12). The numbers represent 5% of the issued and outstanding PubCo Ordinary Shares at the closing. For the terms of the Incentive Plan, see the section in this proxy statement/prospectus entitled "*Management of PubCo Following the Business Combination—Share Incentive Plan.*"

Given that the redemptions of shares by redeeming PNAC Public Stockholders may have a dilutive effect on the non-redeeming PNAC Public Stockholders, as well as on the per-share value of stock held by such non-redeeming PNAC Public Stockholders, the following table demonstrates the effect of the redemptions on the per-share value in different scenarios.

Holders of PubCo Ordinary Shares	Per share value (1) (at December 31, 2022)	Scenario A-No Redemption (2)		Scenario B-25% Redemption (3)		Scenario C-75% Redemption (4)		Scenario D-Maximum Redemption (5)	
		No. of Shares	Fair Value	No. of Shares	Fair Value	No. of Shares	Fair Value	No. of Shares	Fair Value
PNAC Public Shareholders	10.34	4,912,299	50,793,172	4,912,299	50,793,172	4,912,299	50,793,172	4,912,299	50,793,172
PNAC Public Stockholders ("Rights")	10.34	806,250	8,336,625	806,250	8,336,625	806,250	8,336,625	806,250	8,336,625
PNAC Initial Stockholders	10.34	2,011,392	20,797,793	2,011,392	20,797,793	2,011,392	20,797,793	2,011,392	20,797,793
The Sellers	10.34	130,560,928	1,350,000,000	130,560,928	1,350,000,000	130,560,928	1,350,000,000	130,560,928	1,350,000,000
PNCPS Compensation Shares	10.34	609,756	6,304,877	609,756	6,304,877	609,756	6,304,877	609,756	6,304,877
Redemptions of PNAC Class A Common Stock	10.34	-	-	(1,228,075)	(12,698,293)	(3,684,224)	(38,094,879)	(6,450,000)	(66,693,000)
Net assets of PNAC		138,900,625	1,436,232,467	137,672,551	1,423,534,174	135,216,401	1,398,137,588	135,134,716	1,397,292,963
Excess of net assets			\$ 1,371,651,261		\$ 1,358,952,968		\$ 1,333,556,382		\$ 1,332,711,757

- (1). As of the date of this proxy statement/prospectus, there are 4,912,299 PNAC Public Shares issued and outstanding that are subject to redemption. The values expressed in the table above are preliminary and will change based on fluctuations in the share price of the PNAC Stock through the closing date. A one percent change in the market price per share of PNAC Stock and would result in a change to the excess of net identifiable assets of \$14.5 million and \$13.8 million assuming no redemptions and maximum redemptions, respectively.
- (2). The numbers set forth in this column assume that no PNAC Public Shares are redeemed.
- (3). The numbers set forth in this column assume that 1,228,075 PNAC Public Shares, or approximately 25% of 4,912,299 PNAC Public Shares are redeemed at \$10.34 per share.
- (4). The numbers set forth in this column assume that 3,684,224 PNAC Public Shares, or approximately 75% of 4,912,299 PNAC Public Shares are redeemed at \$10.34 per share.
- (5). The numbers set forth in this column assume that all 4,912,299 PNAC Public Shares, or 100% of 4,912,299 PNAC Public Shares are redeemed at \$10.34 per share.

**Q: How will the effective rate of underwriting discounts and commissions paid on capital raised in PNAC's initial public offering and retained after the Business Combination be affected by redemptions?**

A: PNAC sold 6,450,000 shares of PNAC Common Stock in its initial public offering, with investors paying \$10.00 per PNAC Share, representing gross initial public offering proceeds of \$64,500,000. The underwriters in the initial public offering received \$1,290,000 upon completion of the initial public offering and will receive an additional \$2,257,500 upon consummation of the Business Combination, resulting in a 5.5% rate of underwriting discounts and commissions, which represents the underwriters' total underwriting discounts and commissions as a percentage of gross initial public offering proceeds. On May 22, 2023, as a result of redemption requests by PNAC Public Stockholders in connection with a PNAC special stockholder meeting, 1,537,701 PNAC Public Shares were cancelled, resulting in 4,912,299 PNAC Public Shares issued and outstanding as the date of this proxy statement/prospectus. To the extent there are further redemptions, the effective rate of underwriting discounts and commissions paid by PNAC and borne indirectly by its non-redeeming stockholders will be higher after taking into account proceeds used to redeem the shares of redeeming stockholders.

	Scenario A-No Redemption (1)	Scenario B-25% Redemption(2)	Scenario C-75% Redemption(3)	Scenario D-Maximum Redemption(4)
Deferred Underwriting Fee	\$ 2,257,500	\$ 2,257,500	\$ 2,257,500	\$ 2,257,500
Number of Remaining Public Shares (5)	5,718,549	4,490,474	2,034,325	806,250
Cost of Deferred Underwriting Fee Per Share	\$ 0.39	\$ 0.50	\$ 1.11	\$ 2.80
IPO proceeds net of redemption (6)	\$ 48,415,648	\$ 36,311,736	\$ 12,103,912	\$ 0
Deferred Underwriting Fee as % of IPO proceeds net of redemptions	3.5%	6.2%	19%	—

- (1). As of the date of this proxy statement/prospectus, there are 4,912,299 PNAC Public Shares issued and outstanding that are subject to redemption.
- (2). The numbers set forth in this column assume that 1,228,075 PNAC Public Shares, or approximately 25% of 4,912,299 PNAC Public Shares are redeemed at \$10.34 per share and 806,250 PubCo Ordinary Shares are issued in exchange for PNAC rights.
- (3). The numbers set forth in this column assume that 3,684,224 PNAC Public Shares, or approximately 75% of 4,912,299 PNAC Public Shares are redeemed at \$10.34 per share and 806,250 PubCo Ordinary Shares are issued in exchange for PNAC rights.
- (4). The numbers set forth in this column assume that 806,250 PubCo Ordinary Shares are issued in exchange for PNAC rights.
- (5). Numbers include 806,250 PubCo Ordinary Shares issuable in exchange for PNAC rights.
- (6). Numbers do not reflect the interests accrued on trust account.

**Q: What are the U.S. Federal income tax consequences of the Business Combination to U.S. holders of PNAC Common Stock?**

A: Certain material U.S. federal income tax considerations that may be relevant to you in respect of the Business Combination are discussed in more detail in the section titled "Material Tax Considerations—United States Federal Income Tax Considerations." The discussion of the U.S. federal income tax consequences contained in this proxy statement/prospectus is intended to provide only a general discussion and is not a complete analysis or description of all of the U.S. federal income tax considerations that are applicable to you in respect of the Business Combination, nor does it address any tax considerations arising under U.S. state or local or non-U.S. tax laws. You are urged to consult your tax advisors regarding the tax consequences of the Business Combination.

**Q: What are the U.S. federal income tax consequences of exercising my redemption rights?**

A: The receipt of cash by a U.S. holder of PNAC Common Stock in redemption of such shares will be a taxable transaction for U.S. federal income tax purposes. Please see the section entitled “*Material Tax Considerations—United States Federal Income Tax Considerations—Effects to U.S. Holders of Exercising Redemption Rights*” for additional information. You are urged to consult your tax advisors regarding the tax consequences of exercising your redemption rights.

**Q: What conditions must be satisfied to complete the Business Combination?**

A: There are a number of closing conditions to the Business Combination, including, but not limited to, the following:

- the effectiveness of this Form F-4 and the absence of any issued or pending stop order by the SEC;
- approval of the Business Combination Proposal and the Governing Documents Proposal by the PNAC stockholders;
- the accuracy of certain representations and warranties made by noco-noco and the Sellers, except (subject to certain exceptions) where the failure of such representations and warranties to be accurate would not reasonably be expected to have a noco-noco Material Adverse Effect;
- receipt of approval for PubCo Ordinary Shares to be listed on the Nasdaq, subject only to official notice of issuance thereof, and PubCo shall continue to satisfy initial and continuing listing requirements of Nasdaq;
- no governmental order, statute, rule or regulation having been enacted or promulgated enjoining or prohibiting the consummation of the Business Combination;
- the net tangible assets of PubCo upon the consummation with the Business Combination no less than \$5,000,001;
- performance and compliance with all material respects of the Business Combination Agreement applicable to each party, respectively;
- material compliance with pre-closing covenants; and
- Available PNAC Cash is at least \$20,000,000 immediately prior to or upon the Share Exchange Closing.

For a summary of all of the conditions that must be satisfied or waived prior to completion of the Business Combination, see the section entitled “The Business Combination Proposal—The Business Combination Agreement.”

**Q: How many votes do I have at the Special Meeting?**

A: PNAC stockholders are entitled to one vote at the Special Meeting for each PNAC Share held of record as of \_\_\_\_\_, 2023, the record date for the Special Meeting (the “Record Date”). As of the close of business on the Record Date, there were 8,461,392 shares of PNAC Common Stock outstanding.

**Q: What vote is required to approve the proposals presented at the Special Meeting?**

A: The following votes are required for each proposal at the Special Meeting:

- Business Combination Proposal—The approval of the Business Combination Proposal requires the affirmative vote of the holders of a majority of the shares of PNAC Common Stock cast, in person (including virtual presence) or by proxy, in respect of the Business Combination Proposal and entitled to vote thereon at the Special Meeting.

- **Governing Documents Proposal**—The approval of the Governing Documents Proposal requires the affirmative vote of the holders of a majority of the shares of PNAC Common Stock cast, in person (including virtually presence) or by proxy, in respect of the Governing Documents Proposal and vote thereupon at the Special Meeting.
- **Adjournment Proposal**—The approval of the Adjournment Proposal will require the consent of the meeting, which means a simple majority of the votes which are cast by those stockholders of PNAC who are present, in person or by proxy, and vote thereupon at the Special Meeting.

For purposes of the Special Meeting, an abstention occurs when a shareholder attends the meeting and does not vote or returns a proxy with an “abstain” vote.

If you are a PNAC stockholder that attends the Special Meeting and fails to vote on the Business Combination, Governing Documents or Adjournment Proposals, or if you respond to such proposals with an “abstain” vote, your failure to vote or “abstain” vote in each case will have no effect on the vote count for such proposals.

**Q: What constitutes a quorum at the Special Meeting?**

A: A quorum shall be present at the Special Meeting if the holders of a majority of the issued and outstanding shares of PNAC Common Stock entitled to vote at the Special Meeting are present in person or by proxy. If a quorum is not present within half an hour from the time appointed for the Special Meeting to commence, the meeting shall stand adjourned to the same day in the next week at the same time and/or place or to such other day, time and/or place as the directors of PNAC may determine.

As of the Record Date, 3,461,846 shares of PNAC Common Stock would be required to achieve a quorum.

**Q: How do the insiders of PNAC intend to vote on the proposals?**

A: The Sponsors and certain directors and advisors and affiliates of PNAC to whom the Sponsors transferred PNAC Common Stock beneficially own and are entitled to vote an aggregate of approximately 29.05% of the outstanding shares of PNAC Common Stock. These parties are required by certain agreements to vote their securities in favor of the Business Combination Proposal, in favor of the Governing Documents Proposal and in favor of the Adjournment Proposal, if presented at the meeting. As a result, in addition to shares held by these parties, (i) assuming all shares of PNAC Common Stock are voted, PNAC would need at least approximately 29.53% of the outstanding shares of PNAC Common Stock to vote in favor to have the Business Combination Proposal approved, and at least approximately 29.53% of the outstanding shares of PNAC Common Stock to vote in favor to have the Governing Documents Proposal approved; and (ii) assuming only the minimum number of shares of PNAC Common Stock representing a quorum are voted, PNAC would not need any of the outstanding shares of PNAC Common Stock to vote in favor to have the Business Combination Proposal approved, and would not need any of the outstanding shares of PNAC Common Stock to vote in favor have the Governing Documents Proposal approved.

**Q: What interests do PNAC’s Directors and Officers have in the Business Combination?**

A: When considering PNAC Board’s recommendation to vote in favor of approving the Business Combination Proposal and the Governing Documents Proposal, PNAC stockholders should keep in mind that the Sponsors and PNAC’s directors and executive officers, have interests in such proposals that are different from, or in addition to (and which may conflict with), those of PNAC stockholders. These interests include, among other things, the interests listed below:

- the beneficial ownership by the Sponsors of an aggregate of 1,474,000 Founder Shares and 398,892 Private Shares, which would become worthless if PNAC does not complete a business combination within the applicable time period, as the Sponsor has waived any right to redemption with respect to these shares. The Sponsors paid an aggregate of approximately \$25,000, or \$0.017 per share, for the Founders Shares and \$3,988,920, or \$10.00 per share, for the Private Shares. Such shares of PNAC Class A Common Stock held by the Sponsors have an aggregate market value of approximately \$ , based on the closing price of PNAC Class A Common Stock on the Record Date, resulting in a theoretical gain of \$ (or \$ per share);
- Mr. Dongfeng Wang, PNAC’S Chairman and Chief Executive Officer, is the manager of Prime Number Acquisition LLC, a Sponsor of PNAC, and as such may be deemed to have sole voting and investment discretion with respect to the shares of PNAC Class A Common Stock held by Prime Number Acquisition LLC, including 1,383,700 Founder Shares and 349,032 Private Shares as described above. In addition, Mr. Wang directly holds 45,000 Founder Shares, which would become worthless if PNAC does not complete a business combination within the applicable time period, as Mr. Wang has waived any right to redemption with respect to these shares. For the shares directly held by Mr. Wang, Mr. Wang paid an aggregate of approximately \$652.174, or \$0.017 per share, for the Founders Shares. Such shares of PNAC Class A Common Stock directly held by Mr. Wang have an aggregate market value of approximately \$ , based on the closing price of PNAC Class A Common Stock on the Record Date, resulting in a theoretical gain of \$ (or \$ per share). Such shares of PNAC Class A Common Stock held by Prime Number Acquisition LLC have an aggregate market value of approximately \$ , based on the closing price of PNAC Class A Common Stock on the Record Date, resulting in a theoretical gain of \$ (or \$ per share);

- Mr. David Friedman, PNAC'S Chief Financial Officer and director, directly holds 30,000 Founder Shares, which would become worthless if PNAC does not complete a business combination within the applicable time period, as Mr. Friedman has waived any right to redemption with respect to these shares. For the shares directly held by Mr. Friedman, Mr. Friedman paid an aggregate of approximately \$434,783, or \$0.017 per share, for the Founders Shares. Such shares of PNAC Class A Common Stock directly held by Mr. Friedman have an aggregate market value of approximately \$ , based on the closing price of PNAC Class A Common Stock on the Record Date, resulting in a theoretical gain of \$ (or \$ per share);
- Mr. Weixong (Jeff) Cheong, PNAC'S Chief Operating Officer, is the sole director and member of DBG Global Limited. DBG Global Limited is a member of Prime Number Acquisition LLC, a Sponsor of PNAC, and Mr. Cheong, as the sole director and member of DBG Global Limited, may be deemed to have beneficial ownership over 447,561 shares of PNAC Class A Common Stock for which Prime Number Acquisition LLC is the record holder, including 336,565 Founder Shares and 110,996 Private Shares. Such shares of PNAC Class A Common Stock would become worthless if PNAC does not complete a business combination within the applicable time period, as Prime Number Acquisition LLC has waived any right to redemption with respect to these shares. Such shares of PNAC Class A Common Stock held by Prime Number Acquisition LLC have an aggregate market value of approximately \$ , based on the closing price of PNAC Class A Common Stock on the Record Date, resulting in a theoretical gain of \$ (or \$ per share);
- each of the three independent directors of PNAC holds 15,000 Founder Shares, which would become worthless if PNAC does not complete a business combination within the applicable time period, as the independent directors have waived any right to redemption with respect to these shares. Each independent director of PNAC paid approximately \$217,391, or \$0.017 per share for such 15,000 Founder Shares. Such 15,000 Founder Shares held by each independent director have an aggregate market value of approximately \$ , based on the closing price of PNAC Class A Common Stock on the Record Date, resulting in a theoretical gain of \$ (or \$ per share);
- in order to finance transaction costs in connection with an intended initial business combination, the Sponsors, affiliates of the Sponsors, PNAC'S directors and officers, may, but are not obligated to, loan PNAC funds as may be required. Additionally, pursuant to a May 15, 2023 PNAC special stockholder meeting where a certificate of amendment was approved to amend the amended and restated certificate of incorporation of PNAC, which became effective on May 17, 2023, if we extend the time available to us to complete our business combination, our Sponsors, their affiliates or designee may deposit \$125,000, for each one-month extension for up to six times to extend the time for us to complete our business combination. If PNAC completes the Business Combination, PNAC would repay such loaned amounts out of the proceeds of the Trust Account released to PNAC. Otherwise, such loans would be repaid only out of funds held outside the Trust Account. In the event that the Business Combination does not close, PNAC may use a portion of the working capital held outside the Trust Account to repay such loaned amounts but no proceeds from the Trust Account would be used to repay such loaned amounts. Up to \$3,000,000 of such loans may be convertible into the Working Capital Shares, at a price of \$10.00 per share at the option of the lender. As of the date hereof, PNAC had no outstanding balance under the working capital loans as evidenced by the Notes accordingly. In the event that PNAC fails to complete a business combination by May 16, 2023 (or November 16, 2023, if extended), it is uncertain if PNAC has sufficient working capital held outside the Trust Account to fully repay any outstanding loans, and the Sponsors may be eventually held liable for PNAC'S liabilities pursuant to its certain indemnification obligations;
- the fact that the PNAC Initial Stockholders (including the Sponsors, certain PNAC officers and directors) have agreed not to redeem any PNAC Founder Shares and PNAC Private Shares held by them in connection with a shareholder vote to approve the proposed Business Combination;
- the fact that given the very low purchase price (of \$25,000 in aggregate) that the PNAC Initial Stockholders paid for the PNAC Founder Shares as compared to the price of the PNAC Common Stock sold in PNAC IPO, the PNAC Initial Stockholders may earn a positive rate of return on their investment even if the PubCo Ordinary Shares trade below the price initially paid for the PNAC Common Stock in the PNAC IPO and the PNAC Public Stockholder may experience a negative rate of return following the completion of the Business Combination;
- the fact that the PNAC Initial Stockholders have agreed to waive their rights to liquidating distributions from the Trust Account with respect to any PNAC Founder Shares and PNAC Private Shares held by them if PNAC fails to complete an initial business combination by the Final Redemption Date. As a result of waiving liquidating distributions, if PNAC fails to complete an initial business combination by the Final Redemption Date, the Sponsors would lose \$3,988,920 for the purchase of PNAC Private Shares, and the PNAC Initial Stockholders would lose \$25,000 for the purchase of the PNAC Founder Shares, and thus they (other than the PNAC Initial Stockholders that acquired the PNAC Founder Shares for nominal consideration) would incur substantial loss of investment and will not be reimbursed for any out-of-pocket expenses;
- the fact that the PNAC Initial Stockholders may be incentivized to complete the Business Combination, or an alternative initial business combination with a less favorable company or on terms less favorable to stockholders, rather than to liquidate, in which case the PNAC Initial Stockholders would lose their entire investment. As a result, the PNAC Initial Stockholders may have a conflict of interest in determining whether noco-noco is an appropriate business with which to effectuate a business combination and/or in evaluating the terms of the Business Combination;
- the fact that pursuant to the Registration Rights Agreement, the PNAC Initial Stockholders can demand that PubCo register its registrable securities under certain circumstances and will also have piggyback registration rights for these securities in connection with certain registrations of securities that PubCo undertakes;
- the continued indemnification of PNAC'S directors and officers and the continuation of PNAC'S directors' and officers' liability insurance after the Business Combination (i.e. a "tail policy");
- the fact that if the Trust Account is liquidated, including in the event PNAC is unable to complete an initial business combination by the Final Redemption Date, the Sponsors have agreed to indemnify PNAC to ensure that the proceeds in the Trust Account are not reduced below \$10.20 per public share, or such lesser per public share amount as is in the Trust Account on the liquidation date, by the claims of prospective target businesses with which PNAC has entered into a letter of intent, confidentiality or other similar agreement or a business combination agreement or claims of any third party for services rendered or products sold to PNAC, but only if such a vendor or target business has not executed a waiver of any and all rights to seek access to the Trust Account; and
- the fact that the PNAC Initial Stockholders, are, or may in the future become, affiliated with entities that are engaged in a similar business to PNAC. The PNAC Initial Stockholders are not prohibited from sponsoring, or otherwise becoming involved with, any other blank check companies prior to completing the Business Combination. Accordingly, if any of PNAC'S officers or directors becomes aware of a business combination opportunity that is suitable for an entity to which he or she has then current fiduciary or contractual obligations, he or she will honor his or her fiduciary or contractual obligations to present such Business Combination opportunity to such entity, subject to their fiduciary duties under DGCL. In addition, to the fullest extent permitted by applicable laws, the Existing PNAC Charter waives certain applications of the doctrine of corporate opportunity in some circumstances where the application of any such doctrine would conflict with any fiduciary duties or contractual obligations they may have as of the date of the Existing PNAC Charter or in the future, and PNAC will renounce any expectancy that any of the directors or officers of PNAC will offer any such corporate opportunity of which he or she may become aware to PNAC. PNAC does not believe that the pre-existing fiduciary duties or contractual obligations of its officers and directors materially impacted its search for an acquisition target. Further, PNAC does not believe that

the waiver of the application of the corporate opportunity doctrine in the Existing PNAC Charter had any impact on its search for a potential business combination target.

**Q: May the Sponsors or PNAC’s directors, officers or advisors, or their affiliates, purchase shares in connection with the Business Combination, or enter into agreements or transactions with investors and others to provide them with incentives to acquire PNAC Public Shares or vote their PNAC Public Shares in favor of the Business Combination Proposal or Governing Documents Proposal?**

A: In connection with the stockholder vote to approve the proposed Business Combination, the Sponsors and PNAC’s directors, officers, advisors or their affiliates may privately negotiate transactions to purchase shares prior to the Closing from stockholders who would have otherwise elected to have their shares redeemed for cash in conjunction with a proxy solicitation pursuant to the proxy rules for a per share pro rata portion of the Trust Account. None of the Sponsors, directors, officers or advisors, or their respective affiliates, will make any such purchases when they are in possession of any material non-public information not disclosed to the seller of such shares. In addition, the Sponsors and PNAC’s directors, officers, advisors or their affiliates may enter into agreements or transactions with certain investors and others to provide them with incentives to acquire PNAC Public Shares or vote their PNAC Public Shares in favor of the Business Combination Proposal or Governing Documents Proposal. Any purchases, agreements or transactions as provided in the foregoing would include a contractual acknowledgement that such stockholder, although still the record holder of such shares, is no longer the beneficial owner thereof and therefore agrees not to exercise its redemption rights. In the event that the Sponsors, directors, officers or advisors, or their affiliates, purchase shares in privately negotiated transactions from PNAC Public Stockholders who have already elected to exercise their redemption rights, such selling stockholders would be required to revoke their prior elections to redeem their shares for cash.

As of the date of this proxy/prospectus, the Sponsors, PNAC’s directors, officers and advisors, and their affiliates, have not made any purchases of shares and/or warrants from investors, or have agreed to any agreements or transactions with any investors or others to provide such investors or others with incentives to acquire PNAC Public Shares or vote in favor of the Business Combination Proposal or Governing Documents Proposal. If the Sponsor, PNAC’s directors, officers or advisors, or their affiliates, enter into any such arrangements:

- any such purchases of securities would be made at a price no higher than the redemption price;
- shares acquired in such transactions (i) would not be voted in favor of approving the Business Combination and (ii) holders of such shares would waive their right to redemption rights with respect to such shares; and
- PNAC will disclose in a Current Report on Form 8-K prior to the Special Meeting the following information:
  - o the amount of securities purchased in such transaction(s), along with the purchase price;
  - o the purpose of such purchases;
  - o the impact, if any, of the purchases on the likelihood that the Business Combination will be approved;
  - o the identities of security holders who sold such shares (if not purchased on the open market) or the nature of security holders (e.g. 5% security holders) who sold such shares; and
  - o the number of securities for which PNAC has received redemption requests pursuant to its redemption offer.

The purpose of such share purchases and other transactions would be to increase the likelihood that the proposals presented for approval at the Special Meeting are approved. Any such purchases of public shares and other transactions may thereby increase the likelihood of obtaining the necessary approval of PNAC’s stockholders. This may result in the completion of the Business Combination that may not otherwise have been possible. While the exact nature of any incentives has not been determined as of the date of this proxy statement/prospectus, they might include, without limitation, arrangements to protect such investors or holders against potential loss in value of their shares, including the granting of put options and the transfer to such investors or holders of shares or rights owned by the Sponsors for nominal value. Entering into any such arrangements may have a depressive effect on PNAC Public Shares. For example, as a result of these arrangements, an investor or holder may have the ability to effectively purchase shares at a price lower than market and may therefore be more likely to sell the shares it owns, either prior to or immediately after the Special Meeting. If such transactions are effected, the consequence could be to cause the Business Combination to be approved in circumstances where such approval could not otherwise be obtained. Purchases of shares by the persons described above would allow them to exert more influence over the approval of the proposals to be presented at the Special Meeting and would likely increase the chances that such proposals would be approved. As of the date of this proxy statement/prospectus, no agreements to such effect have been entered into with any such investor or holder.

**Q: I am a PNAC Public Stockholder. Do I have redemption rights?**

A: Yes. Pursuant to the Existing PNAC Charter, in connection with the completion of the Business Combination, PNAC Public Stockholders may elect to have their PNAC Public Shares redeemed for cash at the applicable redemption price per share calculated in accordance with the Existing PNAC Charter. For illustrative purposes, as of December 31, 2022, this would have amounted to approximately \$10.34 per share less any owed but unpaid taxes on the funds in the Trust Account. There are currently no owed but unpaid income taxes on the funds in the Trust Account. However, the proceeds deposited in the Trust Account could become subject to the claims of PNAC’s creditors, if any, which would have priority over the claims of PNAC stockholders. Therefore, the per share distribution from the Trust Account in such a situation may be less than originally expected due to such claims. It is expected that the funds to be distributed to PNAC Public Stockholders electing to redeem their shares shall be distributed promptly after the consummation of the Business Combination. If a PNAC Public Stockholder exercises its redemption rights, then such holder shall be exchanging its PNAC Public Shares for cash. Such a PNAC Public Stockholder shall be entitled to receive cash for its PNAC Public Shares only if it properly demands redemption and delivers its shares (either physically or electronically) to PNAC’s transfer agent, VStock, two business days prior to the Special Meeting. A PNAC Public Stockholder, together with any affiliate of such holder and any person with whom such holder is acting in concert or as a “group” (as defined under Section 13(d)(3) of the Exchange Act), may not seek to have more than 15% of the aggregate shares redeemed without the consent of PNAC. The Existing PNAC Charter provide that the Business Combination shall not be consummated if, upon the consummation of the Business Combination, PubCo (as the entity that succeeds PNAC as a public company) does not have at least \$5,000,001 in net tangible assets after giving effect to the payment of amounts that PNAC shall be required to pay to redeeming shareholders upon consummation of the Business Combination. See the section titled “*Special Meeting of PNAC stockholders—Redemption Rights*” for the procedures to be followed if you wish to redeem your shares for cash.

**Q: If I am a holder of the PNAC Units, can I exercise redemption rights with respect to my PNAC Units?**

A: No. You can only exercise redemption rights with respect to your PNAC Public Shares. Holders of outstanding PNAC Units must separate the underlying PNAC Class A Common Stock, PNAC Warrants and PNAC Rights prior to exercising redemption rights with respect to the PNAC Public Shares. If you hold PNAC Units registered in your own name, you must deliver the certificate for such units to VStock, our transfer agent, with written instructions to separate such units into PNAC Public Shares, PNAC Warrants and PNAC Rights. This must be completed far enough in advance to permit the mailing of the PNAC Public Share certificates back to you so that you may then exercise your redemption rights upon the separation of the PNAC Public Shares from the PNAC Units. See “*How do I exercise my redemption rights?*” below. The address of VStock is listed under the question “*Who can help answer my questions?*” below.

If a broker, dealer, commercial bank, trust company, or other nominee holds your PNAC Units, you must instruct such nominee to separate your PNAC Units. Your nominee must send written instructions to VStock, our transfer agent. Such written instructions must include the number of PNAC Units to be separated and the nominee holding such PNAC Units. Your nominee must also initiate electronically, using DTC’s deposit/withdrawal at custodian (DWAC) system, a withdrawal of the relevant PNAC Units and a deposit of relevant number of PNAC Public Shares and PNAC Warrants. This must be completed far enough in advance to permit your nominee to exercise your redemption rights upon the separation of the PNAC Public Shares from the PNAC Units. While this is typically completed electronically the same business day, you should allow at least one full business day to accomplish the separation. If you fail to cause your PNAC Public Shares to be separated from your PNAC Units in a timely manner, you will likely not be able to exercise your redemption rights.

**Q: If I am a holder of the PNAC Rights, can I exercise redemption rights with respect to my PNAC Rights?**

A: No. The holders of PNAC Rights have no redemption rights with respect to the PNAC Rights.

**Q: If I am a holder of the PNAC Warrants, whether, when and how will PNAC exercise its redemption rights with respect to my PNAC Warrants?**

A: PNAC has the ability to redeem outstanding PNAC Warrants at any time after they become exercisable and prior to their expiration, at a price of \$0.01 per warrant, provided that the last reported sales price of PNAC Class A Common Stock equals or exceeds \$16.50 per share (as adjusted for stock splits, stock dividends, reorganizations, recapitalizations and the like) for any 20 trading days within a 30 trading-day period ending on the third business day prior to the date on which PNAC gives proper notice of such redemption and provided certain other conditions are met. The warrants will become exercisable on the later of 30 days after the completion of our initial business combination or 12 months from the closing of this offering, and will expire five years after the completion of our initial business combination or earlier upon redemption or liquidation, as described in this prospectus. As a result, even if PNAC Class A Common Stock trading price exceeds the \$16.50 per share threshold, we are not allowed to redeem public warrants before the Closing and until the warrants become exercisable .

Notice of redemption shall be mailed by first class mail, postage prepaid, by PNAC not less than 30 days prior to the date that fixed by PNAC for the redemption to the registered holders of the PNAC Warrants to be redeemed at their last addresses as they shall appear on the registration books. Any notice mailed in the manner herein provided shall be conclusively presumed to have been duly given whether or not the registered holder received such notice. PNAC will not redeem the PNAC Warrants unless a registration statement under the Securities Act covering the shares of PNAC Class A Common Stock issuable upon exercise of the PNAC Warrants is effective and a current prospectus relating to those shares of PNAC Class A Common Stock is available throughout the 30-day redemption period, except if the PNAC Warrants may be exercised on a cashless basis and such cashless exercise is exempt from registration under the Securities Act. If and when the PNAC Warrants become redeemable by PNAC, PNAC may exercise its redemption right even if PNAC is unable to register or qualify the underlying securities for sale under all applicable state securities laws. If PNAC elect to redeem the PNAC Warrants on a cashless basis, then PNAC will not receive any cash proceeds from the exercise of such PNAC Warrants. See “*Risk Factors – PNAC may redeem the unexpired PNAC Warrants prior to their exercise at a time that is disadvantageous to you, thereby making your PNAC Warrants worthless.*”

**Q: Will how I vote affect my ability to exercise redemption rights?**

A: No. You may exercise your redemption rights regardless of whether you vote or, if you vote, irrespective of whether you vote “FOR” or “AGAINST” the Business Combination Proposal, the Governing Documents Proposal or the Adjournment Proposal. As a result, the Business Combination Agreement can be approved by shareholders who shall redeem their shares and no longer remain shareholders, leaving shareholders who choose not to redeem their shares holding shares in a company with a potentially less liquid trading market for its stock, fewer shareholders and the potential inability to meet the Nasdaq listing standards. See also “*What shall be the relative equity stakes of PNAC stockholders, and the Sellers in PubCo upon completion of the Business Combination?*”

**Q: How do I exercise my redemption rights?**

A: If you are a PNAC Public Stockholder and wish to exercise your right to have your PNAC Public Shares redeemed, you must:

- submit a written request to VStock, PNAC’s transfer agent, in which you (i) request that PNAC redeem all or a portion of your PNAC Common Stock for cash and (ii) identify yourself as the beneficial holder of the PNAC Common Stock and provide your legal name, phone number and address; and
- deliver your share certificates (if any) and other redemption forms (as applicable) to VStock, PNAC’s transfer agent, physically or electronically through The Depository Trust Company (“DTC”).

PNAC Public Stockholders must complete the procedures for electing to redeem their shares in the manner described above prior to or on \_\_\_\_\_, 2023, two business days before the scheduled Special Meeting in order for their shares to be redeemed.

The address of VStock, PNAC’s transfer agent, is listed under the question “*Who can help answer my questions?*” below.



If a PNAC Public Stockholder properly exercises its right to redeem all or a portion of the PNAC Public Shares that it holds and timely delivers its share certificates (if any) and other redemption forms (as applicable) to VStock, PNAC will redeem such PNAC Public Shares for a per share price, payable in cash, equal to the pro rata portion of the amount on deposit in the Trust Account as of two business days prior to the consummation of the Business Combination, including interest earned on the funds held in the Trust Account and not previously released to PNAC. For illustrative purposes, as of December 31, 2022, this would have amounted to approximately \$10.34 per issued and outstanding share less any owed but unpaid taxes on the funds in the Trust Account. [There are currently no owed but unpaid income taxes on the funds in the Trust Account.] However, the proceeds deposited in the Trust Account could become subject to the claims of PNAC's creditors, if any, which would have priority over the claims of PNAC stockholders. Therefore, the per share distribution from the Trust Account in such a situation may be less than originally expected due to such claims. It is expected that the funds to be distributed to PNAC stockholders electing to redeem their shares shall be distributed promptly after the consummation of the Business Combination.

A holder of PNAC Common Stock, together with any affiliate of such holder and any person with whom such holder is acting in concert or as a "group" (as defined under Section 13(d)(3) of the Exchange Act), may not seek to have more than 15% of the aggregate shares redeemed without the consent of PNAC. Under the Existing PNAC Charter, the Business Combination may not be consummated if PubCo (as the entity that succeeds PNAC as a public company) has net tangible assets of less than \$5,000,001 either immediately prior to or upon consummation of the Business Combination after taking into account the redemption for cash of all PNAC Public Shares properly demanded to be redeemed by holders of PNAC Common Stock.

Any request for redemption, once made by a holder of shares, may not be withdrawn once submitted to PNAC unless the PNAC Board determines (in its sole discretion) to permit the withdrawal of such redemption request (which it may or may not do in whole or in part).

Any corrected or changed written exercise of redemption rights must be received by VStock, PNAC's transfer agent, prior to the vote taken on the Business Combination Proposal at the Special Meeting. No request for redemption shall be honored unless the holder's share certificates (if any) and other redemption forms (as applicable) have been delivered (either physically or electronically) to VStock, at least two business days prior to the vote at the Special Meeting.

PNAC shareholders holding both PNAC Class A Common Stock and PNAC Warrants may redeem their PNAC Class A Common Stock but retain the PNAC Warrants, which, if the Business Combination closes, will become PubCo Warrants. The cost of those retained warrants is borne by PubCo and the non-redeeming shareholders. Assuming that 100% of the PNAC Public Shares held by PNAC Public Stockholders were to be redeemed, the [ ] retained outstanding PNAC Warrants, which will be automatically and irrevocably assigned to, and assumed by, PubCo following the Closing of the Business Combination, would have an aggregate value of \$[ ] million, based on a price per PNAC Warrants of \$[ ] on [ ], 2023, the most recent practicable date prior to the date of this proxy statement/prospectus. In addition, on [ ], 2023, the most recent practicable date prior to the date of this proxy statement/prospectus, the price per share of PNAC Class A Common Stock closed at \$[ ]. If PNAC Class A Common Stock are trading above the exercise price of \$11.50 per warrant, the PubCo Warrants are considered to be "in the money" and are therefore more likely to be exercised by the holders thereof (when they become exercisable 30 days following the Closing of the Business Combination) and this in turn increases the risk to non-redeeming shareholders that the PubCo Warrants will be exercised, which would result in immediate dilution to the non-redeeming shareholders.

In addition, once the PubCo Warrants become exercisable, PubCo may redeem the outstanding PubCo Warrants at a price of \$0.01 per warrant upon a minimum number of 30 days' prior written notice of redemption, and if the last sales price of the PubCo Ordinary Shares equals or exceeds \$16.50 per share for any 20 trading days within a 30 trading day period ending three business days before PubCo sends the notice of redemption. For context, as of the close of trading on [ ], 2023 (the most recent practicable date prior to the date of this proxy statement/prospectus), the trading price of PNAC Class A Common Stock on Nasdaq was \$[ ], and the highest and lowest closing price of the PNAC Class A Common Stock during the prior three months was \$[ ] and \$[ ], respectively. Once PubCo Warrants become exercisable after 30 days following the consummation of the Business Combination and PubCo calls for the force redemption once the conditions are met, redemption of the outstanding PubCo Warrants could force holders (i) to exercise their PubCo Warrants and pay the exercise price therefor at a time when it may be disadvantageous for them to do so, (ii) to sell PubCo Warrants at the then-current market price when they might otherwise wish to hold PubCo Warrants or (iii) to accept the nominal redemption price which, at the time the outstanding PubCo Warrants are called for redemption, is likely to be substantially less than the market value of the PubCo Warrants.

If you exercise your redemption rights, then you shall be exchanging your PNAC Common Stock share certificates (if any) for cash and shall not be entitled to PubCo Ordinary Shares upon consummation of the Business Combination.

See the section titled "*Special Meeting of PNAC stockholders—Redemption Rights*" for the procedures to be followed if you wish to redeem your shares for cash.

**Q: What happens if a substantial number of PNAC stockholders vote in favor of the Business Combination Proposal and the Governing Documents Proposal and exercise their redemption rights?**

A: PNAC stockholders may vote in favor of the Business Combination and the Governing Documents Proposal and exercise their redemption rights. Accordingly, the Business Combination may be consummated even though the funds available from the Trust Account and the number of PNAC stockholders are substantially reduced as a result of redemption by PNAC stockholders. The Existing PNAC Charter provides that the Business Combination shall not be consummated if, upon the consummation of the Business Combination, PubCo (as the entity that succeeds PNAC as a public company) does not have at least \$5,000,001 in net tangible assets after giving effect to the payment of amounts that PNAC shall be required to pay to redeeming shareholders upon consummation of the Business Combination. However, pursuant to the Insider Letter Agreement (as defined in the prospectus of PNAC filed on May 16, 2022), each of the Sponsors and certain other directors and officers of the Sponsors has agreed not to redeem such person's shares. In the event of significant redemptions, with fewer shares and fewer PNAC stockholders, the trading market for PubCo Ordinary Shares may be less liquid than the market for PNAC Common Stock was prior to the Business Combination. In addition, in the event of significant redemptions, PubCo may not be able to meet the Nasdaq listing standards. It is a condition to consummation of the Business Combination in the Business Combination Agreement that the PubCo Ordinary Shares to be issued in connection with the Business Combination shall have been approved for listing on the Nasdaq Capital Market, subject only to official notice of issuance thereof. PubCo and PNAC have certain obligations in the Business Combination Agreement to use reasonable best efforts to procure the satisfaction of certain conditions precedent for the consummation of the Business Combination, including with respect to satisfying the Nasdaq listing condition.

**Q: Do I have appraisal or dissenters' rights if I object to the proposed Business Combination?**

A: No PNAC stockholders who hold PNAC Units, shares of Class A Common Stock, PNAC Warrants or PNAC Rights have appraisal or dissenters' rights in connection with the Business Combination under the DGCL. Therefore, no dissenters' rights will be available under the Merger in respect of the PNAC Class A Common Stock; however, holders have a redemption right as further described in this proxy statement/prospectus. See "*Special Meeting of PNAC stockholders—Redemption Rights*" for a detailed description of the procedures to be followed if you wish to redeem your PNAC Public Shares for cash.

**Q: What happens to the funds deposited in the Trust Account after consummation of the Business Combination?**

A: Of the net proceeds of the PNAC IPO (including the net proceeds of the underwriters' exercise of their over-allotment option) and simultaneous private placements, a total of \$65.79 million was placed in the Trust Account immediately following the IPO. After consummation of the Business Combination, the funds in the Trust Account shall be released to pay holders of the PNAC Common Stock who exercise redemption rights and to pay fees and expenses incurred in connection with the Business Combination with noco-noco (including fees of an aggregate of approximately \$2,257,500 to certain underwriters in connection with the IPO). Any remaining funds shall remain on the balance sheet of PubCo after Closing in order to fund noco-noco's existing operations and support new and existing growth initiatives.

**Q: What happens if the Business Combination is not consummated?**

A: We have until July 17, 2023 (or by November 17, 2023, if extended) to complete the Business Combination. If PNAC does not complete the Business Combination with noco-noco (or another initial business combination) by July 17, 2023 (or by November 17, 2023, if extended) (such date the "Final Redemption Date"), PNAC must redeem 100% of the PNAC Public Shares, at a per-share price, payable in cash, equal to the amount then held in the Trust Account (net of taxes payable and less up to \$50,000 of interest to pay dissolution expenses) divided by the number of then-outstanding PNAC Public Shares.

**Q: When do you expect the Business Combination to be completed?**

A: The Business Combination is expected to be consummated promptly following the satisfaction, or waiver, of the conditions precedent to Closing set forth in the Business Combination Agreement, including the approval of the Business Combination Proposal and the Governing Documents Proposal by the shares of PNAC Common Stock. For a description of the conditions for the completion of the Business Combination, see the section entitled "*The Business Combination Proposal—The Business Combination Agreement—Conditions to Closing*." However, there can be no assurance that such conditions will be satisfied or waived or that the Business Combination will occur.

**Q: What are the risks to PNAC stockholders of the Business Combination with noco-noco rather than an underwritten initial public offering of noco-noco's securities?**

A: PubCo has applied for listing, to be effective upon the consummation of the Business Combination, of its ordinary shares, par value \$0.0001 per share on the Nasdaq Capital Market under the symbol " ". Unlike an underwritten initial public offering of PubCo's securities, the listing of PubCo's securities as a result of the Business Combination will not benefit from, including, but not limited to, (i) the book-building process undertaken by underwriters, which helps to inform efficient price discovery with respect to opening trades of newly listed securities; (ii) underwriter support to help stabilize, maintain, or affect the public price of the securities immediately after listing; and (iii) underwriter due diligence review of the offering and potential liability for material misstatements or omissions of fact in a prospectus used in connection with the securities being offered, or for statements made by its securities analysts or other personnel. See "*Risk Factors—The listing of PubCo's securities on Nasdaq will not benefit from the process undertaken in connection with an underwritten initial public offering*" for more information.

**Q: Who will become the executive officers and directors of the PubCo?**

A: It is anticipated that, upon the Closing, the management team of PubCo will consist of Mr. Masataka Matsumura, as the CEO, Ms. Mari Matsushita, as the Chief Product Officer, Mr. Tatsuo Mori, as the head of product management, Mr. Yuta Akakuma, as the head of business development, and Mr. Yoshinori Kurahashi, as the Chief Financial Officer. The PubCo Board will be comprised of Mr. Masataka Matsumura, Ms. Mari Matsushita, Mr. Yuta Akakuma, and three independent directors: Mr. Timothy Lai Wah Teo, Mr. Heizo Takenaka and Mr. Jean-Francois Raymond Roger Minier, who are nominated by noco-noco. See "*Management of PubCo Following the Business Combination*" for more information regarding the management team of PubCo and the PubCo Board after the Closing.

**Q: What else do I need to do now?**

A: PNAC urges you to read carefully and consider the information contained in this proxy statement/prospectus, including the annexes, and to consider how the Business Combination shall affect you as a shareholder of PNAC. Shareholders should then vote as soon as possible in accordance with the instructions provided in this proxy statement/prospectus and on the enclosed proxy card.

**Q: How do I attend the Special Meeting?**

A: The Special Meeting shall be held at \_\_\_\_\_ AM Eastern time, on \_\_\_\_\_, 2023 virtually at \_\_\_\_\_. If you are a holder of record of PNAC Common Stock on the Record Date, you shall be able to attend the Special Meeting online and vote during the Special Meeting and examine the list of holders of record of PNAC Common Stock by visiting \_\_\_\_\_ and entering the control number on your proxy card, voting instruction form or notice included in your proxy materials. You may also attend the meeting telephonically by dialing +1 \_\_\_\_\_ (within the U.S. and Canada, toll-free) or +1 \_\_\_\_\_ (outside of the U.S. and Canada, standard rates apply). The passcode for telephone access is \_\_\_\_\_, but please note that you will not be able to vote or ask questions if you choose to participate telephonically. In light of public health concerns regarding COVID-19, virtual attendance is encouraged.

**Q: How do I vote?**

A: If you are a holder of record of PNAC Common Stock on the Record Date, you may vote remotely at the Special Meeting or by submitting a proxy for the Special Meeting. The Special Meeting shall be held virtually via live webcast at \_\_\_\_\_. You shall be able to attend the Special Meeting online and vote during the Special Meeting by visiting \_\_\_\_\_ and entering the control number on your proxy card, voting instruction form or notice included in your proxy materials. Please note that you will not be able to vote or ask questions if you choose to participate telephonically. You may submit your proxy by completing, signing, dating and returning the enclosed proxy card in the accompanying pre-addressed postage paid envelope. If you hold your shares in "street name," which means your shares are held of record by a broker, bank or nominee, you should contact your broker, bank or nominee to ensure that votes related to the shares you beneficially own are properly counted. In this regard, you must provide the broker, bank or nominee with instructions on how to vote your shares or, if you wish to attend the meeting and vote remotely, obtain a proxy from your broker, bank or nominee and a control number from [proxy agent], available once you have received your proxy by emailing \_\_\_\_\_.

**Q: If my shares are held in "street name," will my broker, bank or nominee automatically vote my shares for me?**

A: No. As disclosed in this proxy statement/prospectus, your broker, bank or nominee cannot vote your shares on the Business Combination Proposal or the Governing Documents Proposal unless you provide instructions on how to vote in accordance with the information and procedures provided to you by your broker, bank or nominee. If you are a PNAC stockholder holding your shares in "street name" and you do not instruct your broker, bank or other nominee on how to vote your shares, your broker, bank or other nominee will not vote your shares on the Business Combination Proposal, the Governing Documents Proposal or the Adjournment Proposal. Such abstentions and broker non-votes will have no effect on the vote count for any of the Proposals.

**Q: What will happen if I return my proxy card without indicating how to vote?**

A: If you sign and return your proxy card without indicating how to vote on any particular proposal, the PNAC Public Shares represented by your proxy will be voted as recommended by the Board with respect to that Proposal.

**Q: May I change my vote after I have mailed my signed proxy card?**

A: Yes. Shareholders may send a later-dated, signed proxy card to [proxy agent] at the address set forth below so that it is received by [proxy agent] prior to the vote at the Special Meeting or attend the Special Meeting by visiting [ ], entering the control number on your proxy card and voting. Shareholders may also revoke their proxy by sending a notice of revocation to [proxy agent], which must be received by [proxy agent] prior to the vote at the Special Meeting.

**Q: What happens if I fail to take any action with respect to the Special Meeting?**

A: If you fail to take any action with respect to the Special Meeting (or the related redemption of your shares) and the Business Combination is approved by shareholders and consummated, you shall become a shareholder of PubCo. If you fail to take any action with respect to the Special Meeting and the Business Combination is not approved, you shall continue to be a shareholder of PNAC.

**Q: What should I do if I receive more than one set of voting materials?**

A: Shareholders may receive more than one set of voting materials, including multiple copies of this proxy statement/prospectus and multiple proxy cards or voting instruction cards. For example, if you hold your shares in more than one brokerage account, you shall receive a separate voting instruction card for each brokerage account in which you hold shares. If you are a holder of record and your shares are registered in more than one name, you shall receive more than one proxy card. Please complete, sign, date and return each proxy card and voting instruction card that you receive in order to cast a vote with respect to all of your PNAC Common Stock.

**Q: What should I do with my share certificate(s)?**

A: PNAC Public Stockholders who do not elect to have their PNAC Public Shares redeemed for a pro rata share of the funds held in the Trust Account need not submit their certificate(s). PNAC Public Stockholders who exercise their redemption rights must deliver their share certificate(s) to VStock (either physically or electronically) or through DTC to VStock at least two business days before the Special Meeting, as described above.

**Q: What happens if I sell my PNAC Common Stock before the Special Meeting?**

A: The Record Date for the Special Meeting is earlier than the date of the Special Meeting and earlier than the date the Business Combination is expected to be completed. If you transfer your shares after the applicable Record Date, but before the Special Meeting date, unless you grant a proxy to the transferee, you shall retain your right to vote at the Special Meeting.

**Q: Who will solicit and pay the cost of soliciting proxies for the Special Meeting?**

A: PNAC will pay the cost of soliciting proxies for the Special Meeting. PNAC has engaged [solicitor agent] (“ ”) to assist in the solicitation of proxies for the Special Meeting. PNAC has agreed to pay a fixed fee of \$ , plus disbursements, and to pay \$ for each holder’s proxy solicited by , to reimburse for its reasonable and documented costs and expenses and to indemnify and its affiliates against certain claims, liabilities, losses, damages and expenses. PNAC will also reimburse banks, brokers and other custodians, nominees and fiduciaries representing beneficial owners of PNAC Common Stock for their expenses in forwarding soliciting materials to beneficial owners of PNAC Common Stock and in obtaining voting instructions from those owners. PNAC’s directors and officers may also solicit proxies by telephone, by facsimile, by mail, on the Internet or in person. They will not be paid any additional amounts for soliciting proxies.

**Q: Where can I find the voting results of the Special meeting?**

A: The preliminary voting results will be announced at the Special meeting. PNAC will publish final voting results of the Special Meeting in a Current Report on Form 8-K within four business days after the Special Meeting.

**Q: Who can help answer my questions?**

A: If you have questions about the proposals or if you need additional copies of this proxy statement/prospectus or the enclosed proxy card you should contact PNAC's proxy solicitor as follows:

[Name & Address]

Individuals call toll-free (tolls apply if calling from outside the United States): +1 [ ]

Email:

To obtain timely delivery, shareholders must request the materials no later than , 2023, or five business days prior to the Special Meeting.

You may also obtain additional information about PNAC from documents filed with the SEC by following the instructions in the section entitled "Where You Can Find More Information."

If you are a holder of PNAC Common Stock and you intend to seek redemption of your shares, you shall need to deliver your shares (either physically or electronically) to PNAC's transfer agent at the address below at least two business days prior to the Special Meeting. If you have questions regarding the certification of your position or delivery of your shares for redemption, please contact PNAC's transfer agent as follows:

VStock Transfer, LLC  
18 Lafayette Place  
Woodmere, NY 11598  
[Name]  
[Email]

## SUMMARY OF THE PROXY STATEMENT/PROSPECTUS

*This summary highlights selected information from this proxy statement/prospectus and does not contain all of the information that is important to you. To better understand the proposals to be submitted for a vote at the Special Meeting, including the Business Combination, you should read this entire document carefully, including the Business Combination Agreement attached as Annex A to this proxy statement/prospectus. The Business Combination Agreement is the legal document that governs the Business Combination and the other transactions that shall be undertaken in connection with the Business Combination. It is also described in detail in this proxy statement/prospectus in the section entitled “The Business Combination Proposal—The Business Combination Agreement.”*

### **The Parties to the Business Combination**

#### ***noco-noco***

noco-noco is an early-stage decarbonization solution provider in Asia, aiming to primarily engage in (i) the leasing of battery products, including batteries and BEVs to commercial transportation companies, and of ESS to renewable power plants and other power plants requiring grid stabilization and backup power; and (ii) carbon abatement solutions for landowners and carbon credit sales. noco-noco operates a unique own-and-lease business model where it manufactures its battery products through OEMs and lease them to its clients. noco-noco relies on an exclusive license-in agreement with 3DOM Alliance to utilize 3DOM Alliance’s intellectual property and technologies to develop and manufacture its own battery products and services. It also engages in carbon abatement solutions and carbon credit sales, and cross-sells them to its battery business clients to offset carbon emissions from their operations.

noco-noco was incorporated under the laws of Singapore on July 25, 2019. The principal executive offices are located at 4 Shenton Way, #04-06 SGX Centre II, Singapore 068807, with a total area of 2,432 square feet. The lease will expire on September 14, 2024. noco-noco’s phone number is (65) 6970 9643 and its contact email address is [contactus@noco-noco.com](mailto:contactus@noco-noco.com). There is no established public trading market for its ordinary shares.

#### **Sellers**

Each Seller is a registered shareholder of noco-noco. Such Seller is either an individual natural person of legal age and sound mind or an entity duly organized, validly existing and in good standing under the laws of the jurisdiction of its formation and has all requisite entity power and authority to own, lease and operate its properties and to carry on its business as now being conducted. Each Seller will be either a Signing Seller (as defined in the Business Combination Agreement) or a Joining Seller (as defined in the Business Combination Agreement). Each Signing Seller is a noco-noco Insider, and in no event shall a shareholder of noco-noco that is not a noco-noco Insider be a party to the Business Combination Agreement prior to the SEC’s declaration of effectiveness of this proxy/registration statement. At any time after the date of the Business Combination Agreement and prior to the Share Exchange Closing, each shareholder of noco-noco that is not a Signing Seller can become a Joining Seller after this proxy/registration statement having been declared effective by the SEC by duly executing and delivering to noco-noco and PNAC a joinder agreement in the form attached to the Business Combination Agreement to become a party thereto. Such joinder agreement shall include an agreement by such shareholder of noco-noco to be bound by the terms and conditions of the Business Combination Agreement applicable to the Seller and an acknowledgment by such shareholder of noco-noco that he/she/it has received the proxy/registration statement prospectus with respect to the Business Combination Transactions. noco-noco shall use reasonable best efforts to procure that each holder of the issued and outstanding share capital of noco-noco is either a Signing Seller or a Joining Seller.

#### **PNAC**

PNAC is a blank check company incorporated on February 25, 2021, as a Cayman Islands exempted company for the purpose of effecting a merger, share exchange, asset acquisition, share purchase, reorganization or similar business combination with one or more businesses or entities. Based on its business activities, PNAC is a “shell company,” as defined under the Exchange Act, because it has no operations and nominal assets consisting almost entirely of cash.

Before the completion of an initial business combination, any vacancy on the board of directors of PNAC may be filled by a nominee chosen by holders of a majority of its PNAC Founder Shares. In addition, before the completion of an initial business combination, holders of a majority of PNAC Founder Shares may remove a member of the board of directors for any reason.

On May 17, 2022, PNAC consummated its initial public offering of 6,450,000 PNAC Units (including 450,000 PNAC Units issued upon the partial exercise of the over-allotment option). Each PNAC Unit consists of one share of PNAC Class A Common Stock, one-half of one redeemable PNAC Warrant, with each whole warrant entitling the holder thereof to purchase one share of PNAC Class A Common Stock at an exercise price of \$11.50 per share, and one PNAC Right, with each right entitling the holder thereof to receive one-eighth (1/8) of one share of PNAC Class A Common Stock upon the completion of an initial business combination. The PNAC Units were sold at an offering price of \$10.00 per PNAC Unit, generating gross proceeds of \$64,500,000.

Substantially concurrently with the closing of the IPO, PNAC completed the private sale of 398,892 shares of the PNAC Private Shares to the Sponsors, including 349,032 shares to Sponsor A, and 49,860 shares to Sponsor B, at a purchase price of \$10.00 per PNAC Private Share, generating gross proceeds to PNAC of \$3,988,920 (including \$3,490,320 from Sponsor A and \$498,600 from Sponsor B).

Following the closing of PNAC's initial public offering, an amount equal to \$65.79 million of the net proceeds from its initial public offering and the sale of the PNAC Private Shares was placed in the Trust Account. The Trust Account may be invested only in U.S. government treasury bills with a maturity of 185 days or less or in money market funds investing solely in United States Treasuries and meeting certain conditions under Rule 2a-7 under the Investment Company Act of 1940, as amended, which invest only in direct U.S. government obligations. As of December 31, 2022, funds in the Trust Account totaled \$66,718,520. Except with respect to interest earned on the funds in the Trust Account that may be released to pay income taxes, the funds held in the Trust Account will not be released from the Trust Account (i) to PNAC, until the completion of its initial business combination, or (ii) to PNAC Public Stockholders, until the earliest of (a) the completion of PNAC's initial business combination, and then only in connection with those shares of PNAC Common Stock that such shareholders properly elected to redeem, subject to the limitations described herein, (b) the redemption of any PNAC Public Shares properly tendered in connection with a shareholder vote to amend the Existing PNAC Charter (A) to modify the substance or timing of PNAC's obligation to provide holders of PNAC Common Stock the right to have their shares redeemed in connection with PNAC's initial business combination or to redeem 100% of PNAC Public Shares if PNAC does not complete its initial business combination by the prescribed date set forth in the Existing PNAC Charter or (B) with respect to any other provision relating to the rights of holders of PNAC Common Stock, and (c) the redemption of PNAC Public Shares if it has not consummated its business combination by the Final Redemption Date, subject to applicable law.

On May 15, 2023, PNAC held a special meeting of stockholders where PNAC stockholders approved the proposal to amend the PNAC's amended and restated certificate of incorporation to allow PNAC until May 17, 2023 to consummate an initial business combination, and to elect to extend the period to consummate an initial business combination up to six times, each by an additional one-month period (each a "Monthly Extension"), for a total of up to six months to November 17, 2023 (the "Final Termination Date"), by depositing to PNAC's Trust Account \$125,000 for each one-month extension. On May 17, 2023, PNAC filed a certificate of amendment to the amended and restated certificate of incorporation, effective on the same date, to effectuate the proposal. In connection with the votes to approve the proposal, 1,537,701 PNAC Public Shares were tendered for redemption on May 13, 2023, and were cancelled on May 22, 2023. As of the date of this proxy statement/prospectus, a total of 4,912,299 PNAC Public Shares are issued and outstanding.

On May 17, 2023, an aggregate of \$125,000 was deposited into the Trust Account for the PNAC Public Stockholders, resulting in the first Monthly Extension by one month from May 17, 2023 to June 17, 2023 to allow for PNAC to consummate the Business Combination. On June 14, 2023, an additional of \$125,000 was deposited into the Trust Account for the PNAC Public Stockholders, resulting in the second Monthly Extension by one month from June 17, 2023 to July 17, 2023 to allow for PNAC to consummate the Business Combination.

PNAC Units are traded on Nasdaq under the symbol "PNACU", shares of PNAC Class A Common Stock under the symbol "PNAC", PNAC Warrants under the symbol "PNACW", and PNAC Rights under the symbol "PNACR", respectively.

PNAC's principal executive office is located at c/o 1129 Northern Blvd., Suite 404, Manhasset, NY 11030, and its telephone number is +1 (347) 329-1575.

#### **PubCo**

Immediately following the Business Combination, PubCo is expected to qualify as a foreign private issuer as defined in Rule 3b-4 under the Exchange Act. PubCo was incorporated on December 28, 2022, solely for the purpose of effectuating the Business Combination described herein. PubCo was incorporated under the laws of the Cayman Islands as an exempted company limited by shares. PubCo does not own any material assets and does not operate any business.

As of the consummation of the Business Combination, the number of directors of PubCo will be increased to seven, two of whom shall be independent directors. After the consummation of the Business Combination, the mailing address of PubCo will be 4 Shenton Way, #04-06 SGX Centre II, Singapore 068807. After the consummation of the Business Combination, PubCo will become the public company.

#### **Merger Sub**

Merger Sub was incorporated on December 21, 2022, solely for the purpose of effectuating the Business Combination described herein. Merger Sub was incorporated as a corporation under the laws of the State of Delaware. Merger Sub does not own any material assets and does not operate any business.

On December 29, 2022, Merger Sub allocated one share to PubCo, pursuant to which it became a wholly owned subsidiary of PubCo. After the consummation of the Business Combination, Merger Sub will merge with and into PNAC, with PNAC surviving as a wholly owned subsidiary of PubCo.

### ***New SubCo***

New SubCo was incorporated on January 25, 2023, solely for the purpose of effectuating the Business Combination described herein. New SubCo was incorporated as a private company limited by share in Singapore. New SubCo does not own any material assets and does not operate any business.

On January 25, 2023 New SubCo issued one share to PubCo, pursuant to which it became a wholly owned subsidiary of PubCo. After the consummation of the Business Combination, New SubCo will acquire all of the issued and outstanding shares of noco-noco from the shareholders of noco-noco, in exchange for PubCo to issue to the shareholders of noco-noco the shares of PubCo.

### **The Business Combination Proposal**

On December 29, 2022, PNAC, Merger Sub, the Sellers and noco-noco entered into the Business Combination Agreement, pursuant to which, subject to the terms and conditions set forth therein, (i) PNAC shall merge with and into Merger Sub, with PNAC being the surviving company and a wholly owned subsidiary of PubCo, and (ii) following the Merger, New SubCo will acquire all of the issued and outstanding shares of noco-noco from the shareholders of noco-noco, or the Sellers, in exchange for PubCo to issue to the Sellers PubCo Ordinary Shares. Capitalized terms in this summary of the Business Combination Proposal not otherwise defined in this proxy statement/prospectus shall have the meanings ascribed to them in the Business Combination Agreement. PubCo and New SubCo joined as parties to the Business Combination Agreement on February 2, 2023 by executing and delivering signatures to the Business Combination Agreement pursuant to Sections 13.18 and 13.19 of the Business Combination Agreement.

### **The Merger**

As a result of the Merger, at the Merger Effective Time, (i) all the property, rights, privileges, powers and franchises, liabilities and duties of Merger Sub and PNAC shall vest in and become the assets and liabilities of PNAC as the surviving company and the separate corporate existence of Merger Sub shall cease to exist, (ii) each issued and outstanding security of Merger Sub immediately prior to the Merger Effective Time and each issued and outstanding security of PNAC immediately prior to the Merger Effective Time shall be subject to the effects of the Merger as set out below.

Subject to the terms and conditions of the Business Combination Agreement, at the Merger Effective Time:

- each PNAC Unit issued and outstanding immediately prior to the Merger Effective Time shall be automatically detached and the holder thereof shall be deemed to hold one share of PNAC Class A Common Stock, one-half of PNAC Warrant, and one PNAC Right;
- each share of PNAC Common Stock issued and outstanding immediately prior to the Merger Effective Time shall be canceled in exchange for the right to receive one PubCo Ordinary Share;
- each PNAC Warrant outstanding immediately prior to the Merger Effective Time shall cease to be a warrant with respect to PNAC Common Stock and be assumed by PubCo and converted into a warrant of PubCo to purchase one PubCo Ordinary Share, subject to substantially the same terms and conditions prior to the Merger Effective Time in accordance with the provisions of the Warrant Assumption Agreement;
- each PNAC Right outstanding immediately prior to the Merger Effective Time shall cease to be a right with respect to PNAC Common Stock and be converted into a right to receive one-eighth (1/8) of one PubCo Ordinary Share, subject to substantially the same terms and conditions prior to the effective time of the Merger, simultaneously with the PubCo having taken all necessary corporate actions prior to the Merger Effective Time to issue a total of 806,250 PubCo Ordinary Shares to all holders of PNAC Rights at the Share Exchange Closing;
- if there are any PNAC Common Stock that are owned by PNAC as treasury shares or owned by any direct or indirect subsidiary of PNAC immediately prior to the Merger Effective Time, such PNAC Common Stock shall be canceled and extinguished without any conversion and for no consideration;



- The sole holder of shares of PubCo issued and outstanding immediately prior to the Merger Effective Time shall, immediately after the Merger Effective Time, sell, transfer and convey all such shares to PubCo for an aggregate of \$0.01 and PubCo shall have taken all corporate action necessary to repurchase such shares, which shares shall thereupon be canceled by PubCo; and
- All of the shares of Merger Sub Common Stock issued and outstanding immediately prior to the Merger Effective Time shall be automatically converted into an equal number of shares of Class A common stock of PNAC (as the surviving company), with the same rights, powers and privileges as the shares so converted and shall constitute the only outstanding shares of capital stock of the PNAC (as the surviving company).

For more information on the Merger, see the sections titled “The Business Combination Proposal—The Business Combination Agreement—General Description of the Business Combination Transactions—The Merger.”

### ***The Share Exchange***

Following the Merger, subject to the terms and conditions set forth in the Business Combination Agreement, at the Share Exchange Closing (i) each Seller shall transfer its ordinary shares of noco-noco to New SubCo, (ii) each Seller shall receive such number of newly issued PubCo Ordinary Shares that is equal to the product of (a) the quotient of (i) \$1,350,000,000 (the “noco-noco Valuation”), divided by (ii) the price per PubCo Ordinary Share that equals to the redemption price of each share of PNAC Class A Common Stock in connection with the Business Combination (the “PubCo Per Share Price”), multiplied by (b) such Seller’s Pro Rata Portion as set out in the Allocation Schedule of the Business Combination Agreement.

In addition, pursuant to corporate actions that PubCo shall take prior to the Merger Effective Time, PubCo shall issue 806,250 PubCo Ordinary Shares to such holders of the PNAC Rights at the Share Exchange Closing, with each PNAC right converted into a right to receive one-eighth (1/8) of one PubCo Ordinary Share upon the Merger Effective Time.

For more information on the Share Exchange and the Business Combination Proposal, see the section titled “The Business Combination Proposal—The Business Combination Agreement—General Description of the Business Combination Transactions—The Share Exchange.”

### ***Representations and Warranties***

Under the Business Combination Agreement, noco-noco and the Sellers, on the one hand, PNAC and the acquisition entities, on the other hand, have each made customary representations and warranties to each other, including without limitation as to such parties’ organization and standing, due authorization, ownership, no conflict; and in the case of the noco-noco, its liabilities, contracts, labor matters, benefit plans, intellectual properties, insurance, environmental matters, privacy and cybersecurity, anti-corruption compliance, anti-money laundering and trade compliance, permits and licenses, and certain other matters, and in the case of PNAC, disclosure and listing compliance as a public company, and certain other matters. Except in the case of fraud, the representations and warranties in the Business Combination Agreement will not survive the Share Exchange Closing.

### ***Covenants and Agreements of the Parties***

The Business Combination Agreement also contains covenants of the parties regarding their conduct during the period between the signing of the Business Combination Agreement and the earlier of the Closing or the termination of the Business Combination Agreement, including covenants regarding (i) the operation of their respective businesses in the ordinary course of business and use their respective commercially reasonable efforts to consummate the Business Combination, (ii) the provision of access to their books and records, preparation of this proxy statement/prospectus, (iii) holding stockholder meeting and obtaining the approvals as required for the Business Combination, (iv) tax matters, (v) confidentiality, (vi) other support activities to give full effect to the Business Combination, (vii) maintenance of insurances and indemnification, (viii) efforts to obtain regulatory approvals and compliance with relevant laws and regulations as applicable, (ix) cooperating and using reasonable best efforts to cause PubCo Ordinary Shares issuable in connection with the Merger and the Share Exchange to list on Nasdaq, and (x) using commercially reasonable efforts to obtain adequate financing to consummate the Business Combination.

noco-noco also agreed, (i) from and after the date of the Business Combination Agreement until the Merger Effective Time, except as otherwise contemplated by the Business Combination Agreement, not to engage in any transactions involving the securities of PNAC without the prior consent of PNAC; (ii) to waive any claims of any kind against, and any right to access, the Trust Account, any trustee of the Trust Account and PNAC to collect from the Trust Account any monies that may be owed to them by PNAC or any of its affiliates for any reason whatsoever, and will not seek recourse against the Trust Account at any time for any reason whatsoever; (iii) to provide updates to its financial statements and with respect to other business developments in connection with the Registration Statement; and (iv) to not solicit or respond to any Alternative Proposals.

The Business Combination Agreement also includes certain covenants on PNAC requiring PNAC to, among others, (i) make appropriate arrangements for disbursements of the funds in the Trust Accounts, in accordance with the Trust Agreement, dated May 12, 2022, and the funds received from the transaction financing; (ii) use reasonable best efforts to ensure PNAC remains listed as a public company and retain the listing for PNAC Common Stock on Nasdaq; (iii) adopt resolutions in connection with acquisition of PubCo securities by certain stockholders of PNAC in accordance with Section 16 of the Exchange Act; (iv) exclusivity; (v) have PubCo adopt a new PubCo Incentive Plan in the agreed form attached to the Business Combination Agreement; and (vi) maintenance of PubCo's status as an "emerging growth company" within the meaning of the Jumpstart Our Business Startups Act of 2012.

### **Conditions to Closing**

In addition to the approval of the Business Combination Proposal and the Governing Documents Proposal, unless waived by the parties to the Business Combination Agreement, the closing of the Business Combination is subject to a number of conditions set forth in the Business Combination Agreement. Other conditions to each party's obligations, include, among others: (i) this proxy statement/prospectus having become effective; (ii) the PubCo Ordinary Shares having been approved for listing on Nasdaq, subject only to official notice of issuance thereof, and PubCo shall continue to satisfy initial and continuing listing requirements of Nasdaq; (iii) no governmental order, statute, rule or regulation having been enacted or promulgated enjoining or prohibiting the consummation of the Business Combination; (iv) no noco-noco Material Adverse Effect; (v) the net tangible assets of PubCo upon the consummation with the Business Combination no less than \$5,000,001; (vi) the representations and warranties of noco-noco and the Sellers being true and correct in all material aspect; (vii) performance and compliance with all material respects of the Business Combination Agreement applicable to each party, respectively; (viii) material compliance with pre-closing covenants; and (ix) Available PNAC Cash is at least \$20,000,000 immediately prior to or upon the Share Exchange Closing. For more information about the closing conditions to the Business Combination, see the section titled "*The Business Combination Proposal—The Business Combination Agreement—Conditions to Closing.*"

### **Related Agreements**

#### **Lock-Up Agreement**

Prior to the Merger Effective Time, certain Sellers and the PNAC Initial Stockholders will enter into lock-up agreements with PNAC and PubCo (the "Lock-up Agreement").

Pursuant to the Lock-Up Agreement, PubCo Ordinary Shares held by such holders are categorized as (i) "Group I Lock-up Shares", referring to the 50% of the total number of PubCo Ordinary Shares that such Seller will receive in connection with the Share Exchange, or 50% of the number of PubCo Ordinary Shares such Holder will receive in converting their PNAC Founder Shares in connection with the Merger, (ii) "Group II Lock-up Shares", referring to the remaining 50% of the total number of PubCo Ordinary Shares that such Seller will receive in connection with the Share Exchange, or 50% of the number of PubCo Ordinary Shares such Holder will receive in converting its PNAC Founder Shares in connection with the Merger; and (iii) "Group III Lock-up Shares", referring to the total number of PubCo Ordinary Shares that such Holder will receive in converting its PNAC Private Shares and its PNAC Working Capital Loan Shares (as defined in the Lock-up Agreement) in connection with the Merger. The Group I Lock-Up Shares, Group-II Lock-up Shares, Group-III Lock-up Shares shall be collectively referred as "Lock-up Shares".

The "Lock-up Period" means (i) with respect to the Group I Lock-up Shares, the period commencing on the Share Exchange Closing Date and ending on the date that is the earlier to occur of (A) six months there-after, or (B) the date on which the closing price of each PubCo Ordinary Share equals or exceeds \$12.50 per share (as adjusted for share splits, share dividends, reorganizations and recapitalizations) for any 20 trading days within any 30-trading day period commencing after the completion of the Share Exchange; (ii) with respect to the Group II Lock-up Shares, the period commencing on the Share Exchange Closing Date and ending on the date that is six months thereafter; (iii) with respect to the Group III Lock-up Shares, the period commencing on the Share Exchange Closing Date and ending on the 30 days thereafter.

The holders will, subject to certain customary exceptions, agree not to, within the Lock-up Period, (i) sell, assign, offer to sell, contract or agree to sell, hypothecate, pledge, grant any option to purchase or otherwise dispose of, directly or indirectly, or establish or increase a put equivalent position or liquidate with respect to or decrease a call equivalent position with respect to any Lock-up Shares, (ii) enter into a transaction that would have the same effect, (iii) enter into any swap, hedge or other arrangement that transfers to another, in whole or in part, any of the economic consequences of ownership of the Lock-Up Shares or otherwise or engage in any short sales or other arrangement with respect to the Lock-Up Shares or (iv) publicly announce any intention to effect any transaction specified in clause (i) or (ii).

#### *Registration Rights Agreement*

Prior to the Share Exchange Closing, PubCo and certain prospective holders of PubCo Ordinary Shares (including PNAC Initial Stockholders, the Sellers and the investors of Transaction Financing) will enter into the Registration Rights Agreement, to be effective upon the Closing pursuant to which, among other things, PubCo will agree to undertake certain resale shelf registration obligations in accordance with the Securities Act and the holders have been granted certain demand and piggyback registration rights. See “*Shares Eligible for Future Sale—Registration Rights.*”

#### *Warrant Assumption Agreement*

Prior to the Merger Closing, PNAC, PubCo and VStock will enter into the Warrant Assumption Agreement, pursuant to which, among other things, PNAC will have assigned all of its rights, interests and obligations in the Existing Warrant Agreement to PubCo effective upon the Merger Closing, and PubCo will have assumed the warrants provided for under the Existing Warrant Agreement.

For more information, see the section titled “*The Business Combination Proposal—Related Agreements.*”

#### ***PNAC Board’s Reasons for the Approval of the Business Combination***

PNAC was organized for the purpose of entering into a merger, capital stock exchange, asset acquisition, stock purchase, reorganization, or similar business combination with one or more businesses.

The Business Combination resulted from a thorough search for a potential target, utilizing PNAC’s resources along with the investment and operation experience of PNAC management and the Board. The terms of the Business Combination are the result of extensive negotiations between PNAC and noco-noco.

From the date of PNAC IPO through the execution of the Business Combination on December 29, 2022, PNAC evaluated various potential target companies. PNAC followed the initial set of criteria and guidelines outlined in the prospectus for the initial public offering to assess the value and the growth of the potential target but did not limit itself to those criteria. PNAC’s management evaluated business combination opportunities made available to them based on the merits of a particular initial business combination which may be based, to the extent relevant, on these general guidelines as well as other considerations, factors, and criteria that they deemed relevant.

Prior to reaching the decision to approve the Business Combination Agreement, the PNAC Board reviewed the results of the business and financial due diligence conducted by PNAC management and third party legal and financial advisors, which included:

1. Extensive meetings with noco-noco’s management.
2. Research on the markets of battery and BEV industry, and carbon abatement solutions and carbon credit sales industry, including historical growth trends and market share information as well as growth financial projections and Selected Public Company Analysis.
3. Review of noco-noco’s strategy on expanding market for X-SEPA Separators.
4. Analysis and review of noco-noco’s historical financial statements.
5. Analysis and review of noco-noco’s MOUs and potential transactions.
6. Review of noco-noco’ business model including its planned future operations and underlying technology.
7. Interviews with senior executives from various business departments of noco-noco.
8. Multiple rounds of discussions with the principal shareholder, the CEO and the senior management of noco-noco on future growth strategy.
11. Review of noco-noco’s constitutional documents, material business contracts and licenses.
12. Review of noco-noco’s related party transactions.
13. Review of prevailing industry changes and challenges in the COVID-19 era.
14. Legal due diligence review conducted by PNAC’s legal counsel.
15. Assessment of noco-noco’s total addressable market, its key competitors, competitive advantages, barriers of entry, and target market share.
16. Assessment of noco-noco’s public company readiness.
17. Assessment of the Renewed License-in Agreement and the upfront payment of the \$30 million licensing fee therein.

For additional information on the set of factors and risks that PNAC Board weighted and considered, and the reasoning for approving the Business Combination, see *“The Business Combination Proposal—PNAC Board’s Reasons for the Approval of the Business Combination”*.

### **U.S. Foreign Investment Review**

The Business Combination may be subject to certain government review, including but not limited to the review by the Committee on Foreign Investment in the United States (CFIUS). CFIUS is an interagency committee authorized to review certain transactions involving foreign investment in the United States by foreign persons in order to determine the effect of such transactions on the national security of the United States. Whether CFIUS has jurisdiction to review an acquisition or investment transaction depends on, among other factors, the nature and structure of the transaction, including the level of beneficial ownership interest and the nature of any information or governance rights involved.

For example, investments that result in “control” of a “U.S. business” by a “foreign person” (in each case, as such terms are defined in 31 C.F.R. Part 800) that might be considered by CFIUS to be a covered transaction that CFIUS would have authority to review. Some of PNAC’s directors and officers, and members of its Sponsors, are “foreign persons” as defined under the relevant regulations. Among PNAC’s management, Mr. Dongfeng Wang, PNAC’s Chairman and Chief Executive Officer, is located in the U.S. and a U.S. permanent resident, and a Hong Kong citizen. Mr. Weixiong (Jeff) Cheong, PNAC’s Chief Operating Officer, is located outside U.S. and a Singapore citizen. Other than Mr. Wang and Mr. Cheong, the rest of our directors and officers are U.S. citizens residing in the U.S. Both Sponsor A, Prime Number Acquisition LLC, which currently holds 25.03% of PNAC’s outstanding shares, and Sponsor B, Glorious Capital LLC, which currently holds 2.02% of PNAC’s outstanding shares, are owned in part, directly or indirectly, by certain Hong Kong or PRC nationals. As a result, an aggregate of 1,208,541 shares, or 17.46% of PNAC’s outstanding shares are held indirectly by non-U.S. persons or persons with foreign citizenship. PNAC is therefore likely considered a “foreign person” under the regulations administered by CFIUS and will continue to be considered as such in the future for so long as the Sponsors have the ability to exercise control over PNAC for purposes of CFIUS’s regulations. Therefore, it could be subject to foreign ownership restrictions and/or CFIUS review if noco-noco is considered to be engaged in a regulated industry or which may affect national security.

Moreover, the scope of CFIUS review was expanded by the Foreign Investment Risk Review Modernization Act of 2018 (“FIRRMA”), to include certain non-passive, non-controlling investments in sensitive U.S. businesses and certain acquisitions of real estate even with no underlying U.S. business. FIRRMA’s implementing regulations, which became effective on February 13, 2020, expanded the scope of CFIUS’s jurisdiction to investments that do not result in control of a U.S. business by a foreign person but afford certain foreign investors certain information or governance rights in a U.S. business that has a nexus to “critical technologies,” “critical infrastructure” and/or “sensitive personal data.” In addition, the implementing regulations also subjects certain categories of investments to mandatory filings. If noco-noco’s business falls within CFIUS’s jurisdiction, PNAC may determine that PNAC is required to make a mandatory filing or that PNAC will submit a voluntary notice to CFIUS, or to proceed with the initial business combination without notifying CFIUS and risk CFIUS intervention, before or after closing the Business Combination. CFIUS may decide to block or delay the Business Combination, impose conditions to mitigate national security concerns with respect to the Business Combination or order us to divest all or a portion of PubCo’s business without first obtaining CFIUS clearance.

As a result of, and upon consummation of the Business Combination, each of PNAC and noco-noco shall become a subsidiary of PubCo, and PubCo shall become a new public company owned by the prior holders of PNAC Common Stock, the prior holders of PNAC Rights, the prior holders of PNAC Warrants, the Sellers, and certain third-party investors of a financing in connection with the Business Combination. PubCo is a holding company incorporated in the Cayman Islands. In addition, noco-noco’s businesses are substantially based in Singapore, with projects and operations in Australia and PNG, and potentially, in Philippines, Indonesia, India, or Thailand in the near future. As a result, PNAC does not expect the Business Combination to result in “control” of a “U.S. business” by a “foreign person.” under the regulations administered by CFIUS. Additionally, it does not expect the business of PNAC to be deemed to have a nexus to “critical technologies,” “covered investment critical infrastructure,” and/or “sensitive personal data” under the regulations administered by CFIUS.

Notwithstanding the above, if our determination is not correct, or if the regulations change or are interpreted differently in the future, the Business Combination may be subject to CFIUS review or review by another U.S. governmental entity and ultimately prohibited. Even if it not prohibited, any review by CFIUS or another government entity may have outsized impacts on, among other things, the certainty, timing and feasibility of the Business Combination, which would significantly limit or completely hinder our ability to complete the Business Combination and force PNAC to liquidate and our warrants to expire worthless, preventing the possibility of any price appreciation that may have occurred in our securities following the Business Combination.

The process of government review, whether by the CFIUS or otherwise, could be lengthy and PNAC has limited time to complete the Business Combination. If PNAC cannot complete the Business Combination by November 17, 2023 (assuming full extension) because the review process drags on beyond such timeframe or because the Business Combination is ultimately prohibited by CFIUS or another U.S. government entity, it may be required to liquidate. If PNAC liquidates, its Public Stockholders may only receive \$10.20 per share, and its warrants and rights will expire worthless. This will also cause you to lose the investment opportunity in noco-noco or another target company and the chance of realizing future gains on your investment through any price appreciation in the combined company.

For more information, see *“Risk Factors—Risks related to PNAC and the Business Combination-- We may not be able to complete the Business Combination if it is subject to U.S. foreign investment regulations and review by a U.S. government entity such as the Committee on Foreign Investment in the United States (CFIUS), or ultimately prohibited.”*

## The Governing Documents Proposal

The shareholders of PNAC will vote on a separate proposal to authorize adoption of the Amended PubCo Charter. Please see the section entitled “*The Governing Documents Proposal*.”

## The Adjournment Proposal

If, based on the tabulated vote, there are insufficient votes at the time of the Special Meeting to authorize PNAC to consummate the Merger or the Business Combination, PNAC’s board of directors may (and PNAC is required under the Business Combination Agreement to) submit a proposal to adjourn the Special Meeting to a later date or dates, if necessary, to permit further solicitation of proxies. Please see the section entitled “*The Adjournment Proposal*.”

## Date, Time and Place of Special Meeting of PNAC stockholders

The Special Meeting of the shareholders of PNAC shall be held virtually via live webcast at \_\_\_\_\_ to consider and vote upon the Business Combination Proposal, the Governing Documents Proposal and if necessary, the Adjournment Proposal.

## Voting Power; Record Date

Shareholders shall be entitled to vote or direct votes to be cast at the Special Meeting if they owned shares of PNAC Common Stock at the close of business on \_\_\_\_\_, 2023, which is the Record Date for the Special Meeting. Shareholders shall have one vote for each PNAC Share owned at the close of business on the record date. If your shares are held in “street name” or are in a margin or similar account, you should contact your broker, bank or nominee to ensure that votes related to the shares you beneficially own are properly counted. Warrants or Rights do not have voting rights. On the Record Date, there were \_\_\_\_\_ shares of PNAC Common Stock outstanding, of which \_\_\_\_\_ were held by the Sponsors and certain directors and officers of PNAC.

## Quorum and Vote of PNAC stockholders

A quorum of PNAC stockholders is necessary to hold a valid meeting. A quorum shall be present at the Special Meeting if the holders of a majority of the outstanding shares entitled to vote at the Special Meeting are present in person or by proxy. An abstention or broker non-vote will be counted towards the quorum requirement but will not count as a vote cast at the Special Meeting. The proposals presented at the Special Meeting shall require the following votes:

- Pursuant to the Existing PNAC Charter, the approval of the Business Combination Proposal requires the affirmative vote of the holders of a majority of the shares of PNAC Common Stock cast, in person (including virtual presence) or by proxy, in respect of the Business Combination Proposal and entitled to vote thereon at the Special Meeting.
- The approval of the Governing Documents Proposal requires the affirmative vote of the holders of a majority of the shares of PNAC Common Stock cast, in person (including virtually presence) or by proxy, in respect of the Governing Documents Proposal and vote thereupon at the Special Meeting.
- The approval of the Adjournment Proposal if presented will require the consent of the meeting, which means a simple majority of the votes which are cast by those PNAC stockholders who are present, in person or by proxy, and vote thereupon at the Special Meeting.
- An abstention or broker non-vote will be counted towards the quorum requirement but will not count as a vote cast at the Special Meeting.

## Redemption Rights

Pursuant to the Existing PNAC Charter, a PNAC Public Stockholder may request that PNAC redeem all or a portion of its PNAC Public Shares for cash if the Business Combination is consummated. As a holder of PNAC Public Shares, you will be entitled to receive cash for any PNAC Public Shares to be redeemed only if you:

- hold PNAC Public Shares;
- submit a written request to VStock, PNAC’s transfer agent, in which you (a) request that PNAC redeem all or a portion of your PNAC Public Shares for cash, and (b) identify yourself as the beneficial holder of the PNAC Public Shares and provide your legal name, phone number and address; and
- deliver share certificates (if any) and other redemption forms (as applicable) to VStock, PNAC’s transfer agent, physically or electronically through The Depository Trust Company.

**PNAC Public Stockholders must complete the procedures for electing to redeem their PNAC Public Shares in the manner described above prior to or on \_\_\_\_\_, 2023 (two business days before the Special Meeting) in order for their PNAC Public Shares to be redeemed.**

**The redemption rights include the requirement that a PNAC Public Stockholder must identify itself in writing as a beneficial holder and provide its legal name, phone number and address to VStock in order to validly redeem its shares.**

If the Business Combination is not consummated, the PNAC Public Shares will be returned to the respective holder, broker or bank. If the Business Combination is consummated, and if a PNAC Public Stockholder properly exercises its right to redeem all or a portion of the PNAC Public Shares that it holds and timely delivers its share certificates (if any) and other redemption forms (as applicable) to VStock, PNAC will redeem such PNAC Public Shares for a per-share price, payable in cash, equal to the pro rata portion of the amount on deposit in the Trust Account as of two business days prior to the consummation of the Business Combination, including interest earned on the funds held in the Trust Account and not previously released to PNAC. If a PNAC Public Stockholder exercises its redemption rights in full, then it will be electing to exchange its PNAC Public Shares for cash and will no longer own PNAC Public Shares. See “*Special Meeting of PNAC stockholders—Redemption Rights*” for a detailed description of the procedures to be followed if you wish to redeem your PNAC Public Shares for cash.

A PNAC Public Stockholder, together with any affiliate of such holder and any person with whom such holder is acting in concert or as a “group” (as defined under Section 13(d)(3) of the Exchange Act), may not seek to have more than 15% of the aggregate shares redeemed without the consent of PNAC. Under the Existing PNAC Charter, the Business Combination may not be consummated if PubCo (as the entity that succeeds PNAC as a public company) has net tangible assets of less than \$5,000,001 either immediately prior to or upon consummation of the Business Combination after taking into account the redemption for cash of all PNAC Public Shares properly demanded to be redeemed by the PNAC Public Stockholders.

Any request for redemption, once made by a PNAC Public Stockholder, may not be withdrawn once submitted to PNAC unless PNAC Board determines (in its sole discretion) to permit the withdrawal of such redemption request (which it may do in whole or in part).

#### **No Appraisal or Dissenters’ Rights**

No PNAC holders who hold PNAC Units, Shares of Class A Common Stock, Warrant or Right have appraisal or dissenters’ rights in connection with the Business Combination under the DGCL. Therefore, no dissenters’ rights will be available under the Merger in respect of the PNAC Class A Common Stock; however, holders have a redemption right as further described in this proxy statement/prospectus. See “*Special Meeting of PNAC stockholders—Redemption Rights*” for a detailed description of the procedures to be followed if you wish to redeem your PNAC Public Shares for cash.

#### **Proxy Solicitation**

Proxies may be solicited by mail, telephone or in person. PNAC has engaged [proxy agent] to assist in the solicitation of proxies.

If a shareholder grants a proxy, it may still vote its shares at the Special Meeting if it revokes its proxy before the Special Meeting. A shareholder may also change its vote by submitting a later-dated proxy as described in the section entitled “*Special Meeting of PNAC stockholders—Revoking Your Proxy.*”

#### **Interests of PNAC’s Directors and Officers in the Business Combination**

When considering the PNAC Board’s recommendation to vote in favor of approving the Business Combination Proposal and the Governing Documents Proposal, PNAC stockholders should keep in mind that the PNAC Initial Stockholders (including the Sponsors, directors and officers of PNAC), have interests in such proposals that are different from, or in addition to (and which may conflict with), those of PNAC stockholders generally. These interests include, among other things, the interests listed below:

- the beneficial ownership by the Sponsors of an aggregate of 1,474,000 Founder Shares and 398,892 Private Shares, which would become worthless if PNAC does not complete a business combination within the applicable time period, as the Sponsor has waived any right to redemption with respect to these shares. The Sponsors paid an aggregate of approximately \$25,000, or \$0.017 per share, for the Founders Shares and \$3,988,920, or \$10.00 per share, for the Private Shares. Such shares of PNAC Class A Common Stock held by the Sponsors have an aggregate market value of approximately \$ , based on the closing price of PNAC Class A Common Stock on the Record Date, resulting in a theoretical gain of \$ (or \$ per share);
- Mr. Dongfeng Wang, PNAC’S Chairman and Chief Executive Officer, is the manager of Prime Number Acquisition LLC, a Sponsor of PNAC, and as such may be deemed to have sole voting and investment discretion with respect to the shares of PNAC Class A Common Stock held by Prime Number Acquisition LLC, including 1,383,700 Founder Shares and 349,032 Private Shares as described above. In addition, Mr. Wang directly holds 45,000 Founder Shares, which would become worthless if PNAC does not complete a business combination within the applicable time period, as Mr. Wang has waived any right to redemption with respect to these shares. For the shares directly held by Mr. Wang, Mr. Wang paid an aggregate of approximately \$652.174, or \$0.017 per share, for the Founders Shares. Such shares of PNAC Class A Common Stock directly held by Mr. Wang have an aggregate market value of approximately \$ , based on the closing price of PNAC Class A Common Stock on the Record Date, resulting in a theoretical gain of \$ (or \$ per share). Such shares of PNAC Class A Common Stock held by Prime Number Acquisition LLC have an aggregate market value of approximately \$ , based on the closing price of PNAC Class A Common Stock on the Record Date, resulting in a theoretical gain of \$ (or \$ per share);

- Mr. David Friedman, PNAC'S Chief Financial Officer and director, directly holds 30,000 Founder Shares, which would become worthless if PNAC does not complete a business combination within the applicable time period, as Mr. Friedman has waived any right to redemption with respect to these shares. For the shares directly held by Mr. Friedman, Mr. Friedman paid an aggregate of approximately \$434,783, or \$0.017 per share, for the Founders Shares. Such shares of PNAC Class A Common Stock directly held by Mr. Friedman have an aggregate market value of approximately \$ \_\_\_\_\_, based on the closing price of PNAC Class A Common Stock on the Record Date, resulting in a theoretical gain of \$ \_\_\_\_\_ (or \$ \_\_\_\_\_ per share);
- Mr. Weixong (Jeff) Cheong, PNAC'S Chief Operating Officer, is the sole director and member of DBG Global Limited. DBG Global Limited is a member of Prime Number Acquisition LLC, a Sponsor of PNAC, and Mr. Cheong, as the sole director and member of DBG Global Limited, may be deemed to have beneficial ownership over 447,561 shares of PNAC Class A Common Stock for which Prime Number Acquisition LLC is the record holder, including 336,565 Founder Shares and 110,996 Private Shares. Such shares of PNAC Class A Common Stock would become worthless if PNAC does not complete a business combination within the applicable time period, as Prime Number Acquisition LLC has waived any right to redemption with respect to these shares. Such shares of PNAC Class A Common Stock held by Prime Number Acquisition LLC have an aggregate market value of approximately \$ \_\_\_\_\_, based on the closing price of PNAC Class A Common Stock on the Record Date, resulting in a theoretical gain of \$ \_\_\_\_\_ (or \$ \_\_\_\_\_ per share);
- each of the three independent directors of PNAC holds 15,000 Founder Shares, which would become worthless if PNAC does not complete a business combination within the applicable time period, as the independent directors have waived any right to redemption with respect to these shares. Each independent director of PNAC paid approximately \$217,391, or \$0.017 per share for such 15,000 Founder Shares. Such 15,000 Founder Shares held by each independent director have an aggregate market value of approximately \$ \_\_\_\_\_, based on the closing price of PNAC Class A Common Stock on the Record Date, resulting in a theoretical gain of \$ \_\_\_\_\_ (or \$ \_\_\_\_\_ per share);
- in order to finance transaction costs in connection with an intended initial business combination, the Sponsors, affiliates of the Sponsors, PNAC'S directors and officers, may, but are not obligated to, loan PNAC funds as may be required. Additionally, if we extend the time available to us to complete our business combination, our Sponsors, their affiliates or designee may deposit \$645,000, for each three-month extension for up to two times to extend the time for us to complete our business combination. If PNAC completes the Business Combination, PNAC would repay such loaned amounts out of the proceeds of the Trust Account released to PNAC. Otherwise, such loans would be repaid only out of funds held outside the Trust Account. In the event that the Business Combination does not close, PNAC may use a portion of the working capital held outside the Trust Account to repay such loaned amounts but no proceeds from the Trust Account would be used to repay such loaned amounts. Up to \$3,000,000 of such loans may be convertible into the Working Capital Shares, at a price of \$10.00 per share at the option of the lender. As of the date hereof, PNAC had no outstanding balance under the working capital loans as evidenced by the Notes accordingly. In the event that PNAC fails to complete a business combination by May 16, 2023 (or November 16, 2023, if extended), it is uncertain if PNAC has sufficient working capital held outside the Trust Account to fully repay any outstanding loans, and the Sponsors may be eventually held liable for PNAC'S liabilities pursuant to its certain indemnification obligations;
- the fact that the PNAC Initial Stockholders (including the Sponsors, certain PNAC officers and directors) have agreed not to redeem any PNAC Founder Shares and PNAC Private Shares held by them in connection with a shareholder vote to approve the proposed Business Combination;
- the fact that given the very low purchase price (of \$25,000 in aggregate) that the PNAC Initial Stockholders paid for the PNAC Founder Shares as compared to the price of the PNAC Common Stock sold in PNAC IPO, the PNAC Initial Stockholders may earn a positive rate of return on their investment even if the PubCo Ordinary Shares trade below the price initially paid for the PNAC Common Stock in the PNAC IPO and the PNAC Public Stockholder may experience a negative rate of return following the completion of the Business Combination;
- the fact that the PNAC Initial Stockholders have agreed to waive their rights to liquidating distributions from the Trust Account with respect to any PNAC Founder Shares and PNAC Private Shares held by them if PNAC fails to complete an initial business combination by the Final Redemption Date. As a result of waiving liquidating distributions, if PNAC fails to complete an initial business combination by the Final Redemption Date, the Sponsors would lose \$3,988,920 for the purchase of PNAC Private Shares, and the PNAC Initial Stockholders would lose \$25,000 for the purchase of the PNAC Founder Shares, and thus they (other than the PNAC Initial Stockholders that acquired the PNAC Founder Shares for nominal consideration) would incur substantial loss of investment and will not be reimbursed for any out-of-pocket expenses;
- the fact that the PNAC Initial Stockholders may be incentivized to complete the Business Combination, or an alternative initial business combination with a less favorable company or on terms less favorable to stockholders, rather than to liquidate, in which case the PNAC Initial Stockholders would lose their entire investment. As a result, the PNAC Initial Stockholders may have a conflict of interest in determining whether noco-noco is an appropriate business with which to effectuate a business combination and/or in evaluating the terms of the Business Combination;
- the fact that pursuant to the Registration Rights Agreement, the PNAC Initial Stockholders can demand that PubCo register its registrable securities under certain circumstances and will also have piggyback registration rights for these securities in connection with certain registrations of securities that PubCo undertakes;
- the continued indemnification of PNAC'S directors and officers and the continuation of PNAC'S directors' and officers' liability insurance after the Business Combination (i.e. a "tail policy");
- the fact that if the Trust Account is liquidated, including in the event PNAC is unable to complete an initial business combination by the Final Redemption Date, the Sponsors have agreed to indemnify PNAC to ensure that the proceeds in the Trust Account are not reduced below \$10.20 per public share, or such lesser per public share amount as is in the Trust Account on the liquidation date, by the claims of prospective target businesses with which PNAC has entered into a letter of intent, confidentiality or other similar agreement or a business combination agreement or claims of any third party for services rendered or products sold to PNAC, but only if such a vendor or target business has not executed a waiver of any and all rights to seek access to the Trust Account; and
- the fact that the PNAC Initial Stockholders, are, or may in the future become, affiliated with entities that are engaged in a similar business to PNAC. The PNAC Initial Stockholders are not prohibited from sponsoring, or otherwise becoming involved with, any other blank check companies prior to completing the Business Combination. Accordingly, if any of PNAC'S officers or directors becomes aware of a business combination opportunity that is suitable for an entity to which he or she has then current fiduciary or contractual obligations, he or she will honor his or her fiduciary or contractual obligations to present such Business Combination opportunity to such entity, subject to their fiduciary duties under DGCL. In addition, to the fullest extent permitted by applicable laws, the Existing PNAC Charter waives certain applications of the doctrine of corporate opportunity in some circumstances where the application of any such doctrine would conflict with any fiduciary duties or contractual obligations they may have as of the date of the Existing PNAC Charter or in the future, and PNAC will renounce any expectancy that any of the directors or officers of PNAC will offer any such corporate opportunity of which he or she may become aware to PNAC. PNAC does not believe that the pre-existing fiduciary duties or contractual obligations of its officers and directors materially impacted its search for an acquisition target. Further, PNAC does not believe that

the waiver of the application of the corporate opportunity doctrine in the Existing PNAC Charter had any impact on its search for a potential business combination target.



The PNAC Initial Stockholders have agreed to, among other things, vote all of their PNAC Founder Shares and PNAC Private Shares in favor of the proposals being presented at the Special Meeting and waive their redemption rights with respect to their PNAC Common Stock in connection with the consummation of the Business Combination. As of the date of this proxy statement/prospectus, the PNAC Initial Stockholders own approximately 29.05% of the issued and outstanding shares of PNAC Common Stock.

At any time at or prior to the Business Combination, during a period when they are not then aware of any material nonpublic information regarding PNAC or its securities, the Sponsors, noco-noco, and/or PNAC's or noco-noco's directors, officers, advisors or respective affiliates may purchase PNAC Public Shares from institutional and other investors who vote, or indicate an intention to vote, against the Business Combination Proposal or Governing Documents Proposal, or execute agreements to purchase such shares from such investors in the future, or they may enter into transactions with such investors and others to provide them with incentives to acquire PNAC Public Shares or vote their PNAC Public Shares in favor of the Business Combination Proposal or Governing Documents Proposal. Such a purchase may include a contractual acknowledgement that such shareholder, although still the record or beneficial holder of PNAC Common Stock, is no longer the beneficial owner thereof and therefore agrees not to exercise its redemption rights.

If the Sponsors, noco-noco, and/or PNAC's or noco-noco's directors, officers, advisors or respective affiliates purchase shares in privately negotiated transactions from PNAC Public Stockholders who have already elected to exercise their redemption rights, then such selling shareholder would be required to revoke their prior elections to redeem their shares. The Sponsors, noco-noco, and/or PNAC's or noco-noco's directors, officers, advisors or respective affiliates may also purchase PNAC Public Shares from institutional and other investors who indicate an intention to redeem PNAC Common Stock, or, if the price per share of PNAC Common Stock falls below \$10.00 per share, then such parties may seek to enforce their redemption rights. The above-described activity could be especially prevalent in and around the time of Closing.

The purpose of such share purchases and other transactions would be to (a) increase the likelihood that: (i) the Business Combination Proposal is approved by the affirmative vote of the holders of a majority of the issued and outstanding shares of PNAC Common Stock entitled to vote, who attend, in person or by proxy, and vote thereupon at the Special Meeting; (ii) the Governing Documents Proposal is approved by the affirmative vote of the holders of a majority of the issued and outstanding shares of PNAC Common Stock entitled to vote, who attend, in person or by proxy, and vote thereupon at the Special Meeting; and (iii) PubCo's net tangible assets (as determined in accordance with Rule 3a51-1(g)(1) of the Exchange Act) being at least \$5,000,001 after giving effect to the transactions contemplated by the Business Combination Agreement and the Transaction Financing; and (b) otherwise limit the number of PNAC Public Shares electing to redeem. The Sponsors, noco-noco and/or PNAC's or noco-noco's directors, officers, advisors or respective affiliates may also purchase shares from institutional and other investors for investment purposes.

Entering into any such arrangements may have a depressive effect on the PNAC Common Stock and the PubCo Shares that the PNAC Common Stock exchangeable into in connection with the Merger. For example, as a result of these arrangements, an investor or holder may have the ability to effectively purchase shares at a lower-than-market price and may therefore be more likely to sell the shares he, she, or they own, either at or before the Business Combination.

If such transactions are executed, then the Business Combination could be completed in circumstances where such consummation would not have otherwise occurred. Share purchases by the persons described above would allow them to exert more influence over approving the proposals to be presented at the Special Meeting and would likely increase the chances that such proposals would be approved.

As of the date of this proxy/prospectus, the Sponsors, PNAC's directors, officers and advisors, and their affiliates, have not made any purchases of shares and/or warrants from investors, or have agreed to any agreements or transactions with any investors or others to provide such investors or others with incentives to acquire PNAC Public Shares or vote in favor of the Business Combination Proposal or Governing Documents Proposal. If the Sponsors or their affiliates enter into any such purchases, agreements or transactions:

- any such purchases of securities would be made at a price no higher than the redemption price;
- shares acquired in such transactions (i) would not be voted in favor of approving the Business Combination and (ii) holders of such shares would waive their right to redemption rights with respect to such shares; and

PNAC will disclose in a Current Report on Form 8-K prior to the Special Meeting the following information: (i) the amount of securities purchased in such transaction(s), along with the purchase price; (ii) the purpose of such purchases; (iii) the impact, if any, of the purchases on the likelihood that the Business Combination will be approved; (iv) the identities of security holders who sold such shares (if not purchased on the open market) or the nature of security holders (e.g. 5% security holders) who sold such shares; and (v) the number of securities for which PNAC has received redemption requests pursuant to its redemption offer.

The existence of financial and personal interests of one or more of PNAC's directors results in conflicts of interest on the part of such director(s) between what he, she, or they may believe is in the best interests of PNAC and what he, she, or they may believe is best for himself, herself, or themselves in determining to recommend that shareholders vote for the proposals. In addition, PNAC's officers have interests in the Business Combination that may conflict with your interests as a shareholder.

Please see "*The Business Combination Proposal—Interests of PNAC's Directors and Officers in the Business Combination*" for additional information on interests of PNAC's directors and officers.

### **Compensation of PNAC Directors, Officers, Sponsors, and their affiliates**

No compensation of any kind, including finder's and consulting fees, will be paid by PNAC to our Sponsors, officers, directors or any of our or their respective affiliates, for services rendered prior to or in connection with the completion of the Business Combination. However, these individuals will be reimbursed for any out-of-pocket expenses related to identifying and investigating potential target businesses and completing the Business Combination. Certain directors and officers of PNAC are direct or indirect members of the Sponsor, and, following the consummation of the Business Combination, each such director and officer of PNAC is entitled to receive PubCo Ordinary Shares and PubCo Warrants then held by the Sponsors as further described in "*Security Ownership of Certain Beneficial Owners and Management.*" for more information.

### **Certain Engagements in Connection with the Business Combination and Related Transactions**

On October 25, 2022, PNAC entered into an engagement letter with Prime Number Capital LLC ("PNCPS") and WestPark Capital, Inc. ("WestPark"), the representatives of the underwriters for the initial public offering of PNAC (the "IPO"), to act as the financial advisors to PNAC (the "Financial Advisory Engagement"). In connection with the Financial Advisory Engagement, PNCPS and Westpark will not receive any additional compensation for services rendered under the Financial Advisory Engagement except the deferred underwriting fee in the amount of \$2,257,500 as provided in a certain underwriting agreement for the IPO dated May 12, 2022 among PNAC, PNCPS and Westpark. PNAC also agrees to reimburse PNCPS and WestPark up to \$20,000 for its reasonable out-of-pocket expenses in connection with the performance of their services thereunder. In addition, on the same date, PNAC separately entered into an engagement letter with PNCPS who would, among others, use its reasonable efforts in identifying and introducing potential targets, value potential business combination and assess the proposed structure for business combination and assist in managing the process and other related service (the "Business Combination Advisory Engagement"). On January 31, 2023, PNAC entered into an amendment to the foregoing engagement letter to set forth the compensation for the Business Combination Advisory Engagement. In connection with the Business Combination Advisory Engagement, PNAC shall pay or cause the surviving entities of the Business Combination to pay PNCPS \$500,000 in cash and issue PNCPS 609,756 PubCo Ordinary Shares upon the Closing of the Business Combination. PNAC also agrees to reimburse PNCPS up to \$5,000 for its reasonable out-of-pocket expenses in rendering their services. In addition, on April 30, 2023, PNAC entered into a Placement Agent Agreement with PNCPS, pursuant to which PNCPS shall act as the placement agent for the solicitation and placement of securities of PNAC, in exchange for a placement fee of 7% of the aggregate gross proceeds received by PNAC from the sales of such securities. Further details of these arrangement are set forth in the section entitled "*Business Combination Proposal—Certain Engagements in Connection with the Business Combination and Related Transactions*". PNCPS and WestPark have not sent, and do not anticipate sending, any notice about ceasing involvement with the Business Combination. In addition, neither has waived the deferred underwriting fee from PNAC's IPO.

### **Recommendation to PNAC stockholders**

PNAC's Board believes that each of the proposals to be presented at the Special Meeting is fair to, and in the best interests of, PNAC and unanimously recommends that its stockholders vote "FOR" the Business Combination Proposal, "FOR" the Governing Documents Proposal and "FOR" the Adjournment Proposal, if presented.

The existence of financial and personal interests of one or more of PNAC's directors results in conflicts of interest on the part of such director(s) between what he, she or they may believe is in the best interests of PNAC and its shareholders and what he, she or they may believe is best for himself, herself or themselves in determining to recommend that shareholders vote for the proposals. In addition, PNAC's officers have interests in the Business Combination that may conflict with your interests as a shareholder. See the section entitled "*The Business Combination Proposal—Interests of PNAC's Directors and Executive Officers in the Business Combination*" for a further discussion of these considerations.

### **Certain Information Relating to PubCo and PNAC**

#### **PubCo Listing**

PubCo has applied for listing, to be effective at the time of the Closing of the Business Combination, of the PubCo Ordinary Shares on the Nasdaq and expects to obtain clearance by DTC as promptly as practicable following the issuance thereof, subject to official notice of issuance, prior to the Closing Date.

#### **Delisting and Deregistration of PNAC**

If the Business Combination is completed, PNAC Units, PNAC Class A Common Stock, PNAC Warrants and PNAC Rights shall be delisted from Nasdaq and shall be deregistered under the Exchange Act.

#### **Emerging Growth Company**

Upon consummation of the Business Combination, PubCo will be an "emerging growth company" as defined in the JOBS Act. PubCo will remain an "emerging growth company" until the earliest to occur of (i) the last day of the fiscal year (a) following the fifth anniversary of the closing of the Business Combination, (b) in which PubCo has total annual gross revenue of at least \$1.235 billion or (c) in which PubCo is deemed to be a large accelerated filer, which means the market value of PubCo Ordinary Shares held by non-affiliates exceeds \$700 million as of the last business day of PubCo's prior second fiscal quarter, PubCo has been subject to Exchange Act reporting requirements for at least 12 calendar months; and filed at least one annual report, and (ii) the date on which PubCo issued more than \$1.0 billion in non-convertible debt during the prior three-year period. PubCo intends to take advantage of exemptions from various reporting requirements that are applicable to most other public companies, whether or not they are classified as "emerging growth companies," including, but not limited to, an exemption from the provisions of Section 404(b) of the Sarbanes-Oxley Act requiring that PubCo's independent registered public accounting firm provide an attestation report on the effectiveness of its internal control over financial reporting and reduced disclosure obligations regarding executive compensation.

Furthermore, even after PubCo no longer qualifies as an "emerging growth company," as long as PubCo continues to qualify as a foreign private issuer under the Exchange Act, PubCo will be exempt from certain provisions of the Exchange Act that are applicable to U.S. domestic public companies as further described below.

#### **Code of Business Conduct and Ethics**

PubCo will adopt a new code of business conduct and ethics (the "Code of Business Conduct and Ethics") that applies to all directors, executive officers and employees. It will be available on PubCo's website upon the effectiveness of the registration statement of which this proxy statement/prospectus forms a part. PubCo's Code of Business Conduct and Ethics is a "code of ethics," as defined in Item 406(b) of Regulation S-K. Copies of the code of business conduct and charters for each of PubCo's board committees will be provided without charge upon request from PubCo and will be posted on its website. PubCo will make any legally required disclosures regarding amendments to, or waivers of, provisions of PubCo's Code of Business Conduct and Ethics on its Internet website.

**Foreign Private Issuer and Controlled Company Exemptions**

As a “foreign private issuer,” PubCo will be subject to different U.S. securities laws than domestic U.S. issuers. The rules governing the information that PubCo must disclose differ from those governing U.S. companies pursuant to the Exchange Act. PubCo will be exempt from the rules under the Exchange Act prescribing the furnishing and content of proxy statements to shareholders. Those proxy statements are not expected to conform to Schedule 14A of the proxy rules promulgated under the Exchange Act.

In addition, as a “foreign private issuer,” PubCo’s officers and directors and holders of more than 10% of the issued and outstanding PubCo Ordinary Shares, will be exempt from the rules under the Exchange Act requiring insiders to report purchases and sales of ordinary shares as well as from Section 16 short swing profit reporting and liability.

PubCo will also be exempt from the rules under the Exchange Act requiring the filing with the SEC of quarterly reports on Form 10-Q containing unaudited financial and other specified information, and current reports on Form 8-K, upon the occurrence of specified significant events. In addition, PubCo will not be required to file annual reports and financial statements with the SEC as promptly as U.S. domestic companies whose securities are registered under the Exchange Act, and are not required to comply with Regulation FD, which restricts the selective disclosure of material information.

In addition, immediately after the consummation of the Business Combination, 3DOM Alliance will hold more than 50% of PubCo’s voting power. As a result, PubCo will be a “controlled company” within the meaning of the corporate governance standards of the Nasdaq listing rules. Under these rules, a company of which more than 50% of the voting power in the election of directors is held by an individual, group or another company is a “controlled company” and may elect not to comply with certain corporate governance requirements.

As a result of its status as a “foreign private issuer” and a “controlled company,” among other things, PubCo is not required to have:

- a majority of the board of directors consisting of independent directors;
- a compensation committee consisting of independent directors;
- a nominating committee consisting of independent directors; or
- regularly scheduled executive sessions with only independent directors each year.

As a foreign private issuer and a controlled company, PubCo will be permitted to, and PubCo may, rely on exemptions from certain Nasdaq Stock Exchange corporate governance standards applicable to domestic U.S. issuers. This may afford less protection to holders of PubCo Ordinary Shares.

See “*Risk Factors—Risks Related to PubCo and Ownership of PubCo’s Shares—Because we are a “controlled company” as defined in the Nasdaq Stock Market Rules, you may not have protections of certain corporate governance requirements which otherwise are required by Nasdaq’s rules*” and “*Risk Factors—Risks Related to PubCo and Ownership of PubCo’s Shares—PubCo is a company incorporated in the Cayman Islands and will qualify as a foreign private issuer within the meaning of the rules under the Exchange Act, and as such PubCo is exempt from certain provisions applicable to United States domestic public companies.*”

#### **Material Tax Consequences**

As described in “*Material Tax Considerations—United States Federal Income Tax Considerations—Effects of the Business Combination to U.S. Holders,*” it is intended that the Business Combination qualifies as a “reorganization” within the meaning of Sections 368(a)(1)(F) and 368(a)(2)(D) of the Code. Assuming that the Business Combination so qualifies, U.S. Holders (as defined in “*Material Tax Considerations—United States Federal Income Tax Considerations*”) of PNAC securities will generally not recognize gain or loss for U.S. federal income tax purposes on the Merger. See the section titled “*Material Tax Considerations—United States Federal Income Tax Considerations—Effects of the Business Combination to U.S. Holders.*”

In the event that a U.S. Holder elects to redeem its PNAC Public Shares for cash, the treatment of the transaction for U.S. federal income tax purposes will depend on whether the redemption qualifies as a sale or exchange of the PNAC Public Shares under Section 302 of the Internal Revenue Code (the “Code”). If the redemption qualifies as a sale or exchange of the PNAC Public Shares, the U.S. Holder will be treated as recognizing capital gain or loss equal to the difference between the amount realized on the redemption and such U.S. Holder’s adjusted tax basis in the PNAC Public Shares surrendered in such redemption transaction. There may be certain circumstances, however, in which the redemption may be treated as a distribution for U.S. federal income tax purposes depending on the amount of PNAC Common Stock that such U.S. Holder owns or is deemed to own after the redemption. See the section titled “*Material Tax Considerations—United States Federal Income Tax Considerations—Effects to U.S. Holders of Exercising Redemption Rights.*”

#### **Anticipated Accounting Treatment**

The Business Combination is made up of the series of transactions provided for in the Business Combination Agreement as described elsewhere within this proxy statement/prospectus. The Business Combination will be accounted for as a capital reorganization. Under this method of accounting, PubCo will be treated as the acquired company for financial reporting purposes. Accordingly, the Business Combination will be treated as the equivalent of noco-noco issuing shares at the Closing for the net assets of PNAC as of the Closing Date, accompanied by a recapitalization. The net assets of PNAC will be stated at historical cost, with no goodwill or other intangible assets recorded and operations prior to the Business Combination will be those of noco-noco. noco-noco has been determined to be the accounting acquiror for purposes of the Business Combination based on an evaluation of the following facts and circumstances Notwithstanding the legal form, the Business Combination will be accounted for as a reverse recapitalization in accordance with GAAP:

- noco-noco’s operations prior to the Business Combination will comprise the ongoing operations of PubCo;
- noco-noco’s existing senior management team will comprise all or majority of the senior management team of PubCo; and
- noco-noco’s shareholders, or the Sellers, are expected to have a majority of the voting power of PubCo.

## Regulatory Matters

The Business Combination Agreement and the transactions contemplated by the Business Combination Agreement are not subject to a closing condition that any additional federal, state or foreign regulatory requirement or approval be obtained, except for filings with the registrar of the Cayman Islands necessary to effectuate the transactions contemplated by the Business Combination Agreement and filings with ACRA in connection with the Business Combination.

## Risk Factor Summary

In evaluating the proposals to be presented at the Special Meeting of the PNAC stockholders, a stockholder should carefully read this proxy statement/prospectus and especially consider the factors discussed in the section titled “Risk Factors.”

The consummation of the Business Combination and the business and financial condition of PubCo subsequent to the Closing are subject to numerous risks and uncertainties, including those highlighted in the section title “*Risk Factors*.” The occurrence of one or more of the events or circumstances described below, alone or in combination with other events or circumstances, may adversely affect PNAC’s ability to effect the Business Combination, and may have an adverse effect on the business, cash flows, financial condition and results of operations of PNAC prior to the Business Combination and that of PubCo subsequent to the Business Combination. Such risks include, but are not limited to:

- noco-noco is an early stage company with a history of financial losses, and its battery business expects to incur significant expenses and continuing losses for the foreseeable future;
- noco-noco’s business model has yet to be tested and any failure to commercialize its strategic plans would have an adverse effect on its operating results and business, harm its reputation and could result in substantial liabilities that exceed its resources;
- noco-noco’s business plan may not prove successful, is subject to legal and regulatory risks and its products may not be well-accepted by the markets, which could materially and adversely affect its prospects;
- The success of noco-noco’s business significantly relies on its relationship with 3DOM Alliance. If 3DOM Alliance no longer exclusively licenses their intellectual property rights and technologies to noco-noco, noco-noco’s business, financial position, results of operations and prospect would be materially and adversely affected;
- noco-noco’s business and future growth depends on the growth in demand for BEVs, hybrid vehicles and alternative fuel;
- The EV battery market continues to evolve and is highly competitive, and other battery manufacturers have significantly greater resources than noco-noco does;
- noco-noco’s future success depends on the needs and success of its clients, as well as the demand for its clients’ products or services;
- Many of noco-noco’s target clients are large commercial transportation companies, renewable energy plants and power plants, and the failure to maintain existing clients and secure new clients, withdrawal of leasing services by such clients or failure to negotiate acceptable terms in contract renewal negotiations could have an adverse impact on its business;
- noco-noco may not be able to engage target clients successfully and to convert such contacts into meaningful orders in the future;

- If noco-noco is unable to establish and maintain confidence in its long-term business prospects among clients and analysts and within its industry or are subject to negative publicity, then its financial condition, operating results, business prospects and access to capital may suffer materially;
- If any of noco-noco's battery products fails to perform as expected, its ability to develop, market and sell its products and services could be harmed;
- noco-noco's battery products will require extensive safety testing prior to being offered to its lessees or installed in electric vehicles and power plants;
- Any decline in the value of carbon credits or carbon offsets could materially adversely affect noco-noco's business;
- noco-noco's operating and financial results forecast relies in large part upon assumptions and analyses developed by noco-noco. If these assumptions or analyses prove to be incorrect, noco-noco's actual operating results may be materially different from its forecasted results;
- PNAC will have limited rights after the Closing to make claims for damages against noco-noco or noco-noco's stockholders for the breach of representations, warranties, or covenants made by noco-noco in the Business Combination Agreement;
- The Business Combination is subject to conditions, including certain conditions that may not be satisfied on a timely basis, if at all; and
- The other risks and uncertainties discussed in "Risk Factors" elsewhere in this proxy statement/prospectus.

## SELECTED HISTORICAL FINANCIAL DATA OF PNAC

The following tables present PNAC's selected historical financial information derived from PNAC's audited financial statements included elsewhere in this proxy statement/prospectus as of December 31, 2022 and for the period from February 25, 2021 (inception) through December 31, 2021.

The financial data set forth below should be read in conjunction with, and is qualified by reference to, "Management's Discussion and Analysis of Financial Condition and Results of Operations of PNAC" and the financial statements and notes thereto included elsewhere in this proxy statement/prospectus. PNAC's financial statements are prepared and presented in accordance with U.S. GAAP.

### Statements of Operations

	For the year ended December 31, 2022 (Audited)	For the period from February 25, 2021 (inception) through December 31, 2021 (Audited)
Operating expenses	\$ (636,953)	\$ (1,357)
Net loss	\$ 141,931	\$ (1,357)
Basic and diluted weighted average shares outstanding of redeemable common stock	4,040,110	—
Basic and diluted net income per share of redeemable common stock	0.93	—
Basic and diluted weighted average shares outstanding of non-redeemable common stock	\$ 1,906,243	\$ 1,044,862(1)
Basic and diluted net income per share of non-redeemable common stock	\$ (1.90)	\$ (0.00)

(1) Excludes an aggregate of 225,000 shares of Class A common stock subject to forfeiture if the over-allotment option is not exercised in full or in part by the underwriters.

### Balance Sheets

	As of December 31, 2022 (Audited)	As of December 31, 2021 (Audited)
Current assets	\$ 67,122,199	\$ 373,643
Non-current assets	—	—
<b>TOTAL ASSETS</b>	<b>67,122,199</b>	<b>\$ 373,643</b>
Current Liabilities	\$ 2,540,993	350,000
Non-current liabilities	—	—
<b>TOTAL LIABILITIES</b>	<b>2,540,993</b>	<b>350,000</b>
Common stock subject to possible redemption, 6,450,000 shares at redemption value of \$10.34 per share	66,718,520	—
Shareholders' deficit	(2,137,314)	23,643
<b>TOTAL LIABILITIES AND SHAREHOLDERS' EQUITY (DEFICIT)</b>	<b>\$ 67,122,199</b>	<b>\$ 373,643</b>

### Statements of Cash Flows

	For the Year Ended December 31, 2022 (Audited)	For the period from February 25, 2021 (inception) through December 31, 2021 (Audited)
Cash used in operating activities	\$ (628,480)	\$ (2,057)
Cash used in investing activities	(65,790,000)	—
Cash provided by financing activities	66,571,472	127,360
Net change in cash	152,992	125,303
Cash, beginning of period	125,303	—
Cash, end of period	\$ 278,295	\$ 125,303

## SELECTED HISTORICAL FINANCIAL DATA OF NOCO-NOCO

The following tables present noco-noco's selected historical financial information derived from noco-noco's audited financial statements included elsewhere in this proxy statement/prospectus as of June 30, 2022 and unaudited financial statements for the six months ended December 31, 2022 and PNAC's audited financial statements included elsewhere in this proxy statement/prospectus as of June 30, 2022 and unaudited financial statements for the six months ended December 31, 2022

The financial data set forth below should be read in conjunction with, and is qualified by reference to, "Management's Discussion and Analysis of Financial Condition and Results of Operations of noco-noco" and the audited consolidated financial statements and notes thereto included elsewhere in this proxy statement/prospectus. noco-noco's audited consolidated financial statements are prepared and presented in accordance with U.S. GAAP. The historical results included below and elsewhere in this proxy statement/prospectus are not indicative of the future performance of noco-noco following the Business Combination.

### Statements of Operations and Comprehensive Loss

	<b>For the six months ended December 31,</b>	
	<b>2022</b>	<b>2021</b>
	<b>(Unaudited)</b>	<b>(Unaudited)</b>
Operating expenses	\$ 1,189,696	\$ 611,193
Other income	35,046	8,365
Net loss	<u>\$ (1,154,650)</u>	<u>\$ (602,828)</u>
Other comprehensive (loss)/income	(15,836)	(28,714)
Comprehensive loss	<u>(1,170,487)</u>	<u>(631,542)</u>
Basic and diluted loss per ordinary share	<u>\$ (3.75)</u>	<u>\$ (10.29)</u>
Basic and diluted weighted average number of ordinary shares outstanding	<u>\$ 311,905</u>	<u>\$ 61,368</u>

### Balance Sheets

	<b>As of December 31,</b>	<b>As of</b>
	<b>2022</b>	<b>June 30, 2022</b>
	<b>(Unaudited)</b>	
Current assets	\$ 517,075	\$ 183,889
Non-current assets	320,423	55,532
Total assets	<u>837,498</u>	<u>239,421</u>
Current liabilities	\$ 1,877,603	\$ 1,024,244
Non-current liabilities	124,918	-
Total liabilities	2,002,521	1,024,244
Shareholders' deficit	(1,165,023)	(784,823)
Total liabilities and shareholders' deficit	<u>\$ 837,498</u>	<u>\$ 239,421</u>

### Statements of Cash Flows

	<b>As of</b>	<b>As of</b>
	<b>December 31, 2022</b>	<b>June 30, 2022</b>
	<b>(Unaudited)</b>	
Cash used in operations	(1,341,533)	(805,177)
Cash used in investing activities	(5,735)	(3,888)
Cash generated from financing activities	1,496,657	873,066
Increase in cash and cash equivalents	149,389	64,001
Cash and cash equivalents at beginning of period	81,626	31,690
Cash and cash equivalents at end of period	<u>\$ 214,449</u>	<u>\$ 81,626</u>



## SELECTED UNAUDITED PRO FORMA CONDENSED COMBINED FINANCIAL INFORMATION

The summary unaudited pro forma condensed combined balance sheet as of December 31, 2022 and the unaudited pro forma combined statement of operations for the year ended December 31, 2022 are based on (i) the unaudited financial statements of NOCO-NOCO PTE. LTD. (“noco-noco”) as of December 31, 2022, (ii) the audited financial statements of Prime Number Acquisition I Corp. (“PNAC”) as of December 31, 2022. The summary unaudited pro forma condensed combined financial statements has been derived from and should be read in conjunction with the unaudited pro forma condensed combined financial statements, including the notes thereto, which is included in this proxy statement prospectus under the section titled “Unaudited Pro Forma Condensed Combined Financial Statements.”

The unaudited pro forma condensed combined balance sheet as of December 31, 2022 and the unaudited pro forma combined statement of operations for the year ended December 31, 2022 give pro forma effect to the acquisition of the noco-noco and PNAC.

The unaudited pro forma condensed combined financial statements do not necessarily reflect what the combined company’s financial condition or results of operations would have been had the acquisition of the noco-noco and PNAC occurred on the dates indicated. The unaudited pro forma condensed combined financial statements also may not be useful in predicting the future financial condition and results of operations of the combined company. The actual financial position and results of operations may differ significantly from the pro forma amounts reflected herein due to a variety of factors. The unaudited pro forma condensed combined financial statements are presented for illustrative purposes only and does not reflect the costs of any integration activities or cost savings or synergies that may be achieved as a result of the acquisition. See “Risk Factors—Risks Related to PNAC and the Business Combination—Our actual financial position and results of operations may differ materially from the unaudited pro forma financial information included in this proxy statement/prospectus.”

The following table sets out summary data derived from the unaudited pro forma condensed combined balance sheet and the unaudited pro forma condensed combined statement of operations for the year ended December 31, 2022 under the scenarios:

- Scenario A—Assuming No Redemptions: This presentation assumes that no shareholders of PNAC elect to have their PNAC Shares redeemed for cash in connection with the Business Combination as permitted by PNAC’s amended and restated certificate of incorporation.
- Scenario D—Assuming Maximum Redemptions: This presentation assumes that the shareholders of PNAC elect to redeem all remaining shares and 806,250 PubCo Ordinary Shares are issued in exchange for PNAC rights.

	Historical		Pro Forma Combined	
	Sub Co (noco-noco)	PNAC <sup>(1)</sup>	No Redemption Scenario	Maximum Redemption Scenario
<b>Summary unaudited pro forma condensed combined statement of operations data for the year ended December 31, 2022</b>				
Net (loss) income	(1,629,911)	141,931	(10,692,825)	(10,692,825)
Pro forma net loss per share – basic and diluted (US\$ per share)	(5.22)	0.07	(0.08)	(0.08)
<b>Summary unaudited pro forma condensed combined statement of financial position as of December 31, 2022</b>				
Total assets	837,498	67,122,199	46,686,999	748,433
Total liabilities	2,002,521	2,540,993	3,364,285	7,131,367
Shareholders’ equity	(1,165,023)	(2,137,314)	43,322,714	(6,382,934)
Book value per share <sup>(1)</sup>	\$ (3.73)	\$ (1.06)	\$ 0.31	(0.05)
Net loss per share—basic and diluted – redeemable common stock	\$ —	\$ 0.93	—	—
Weighted average shares outstanding—basic and diluted of redeemable common stock	—	4,040,110	—	—
Net loss per share—basic and diluted – non-redeemable common stock	\$ —	\$ (1.90)	—	—
Weighted average shares outstanding—basic and diluted of non-redeemable common stock	\$ —	1,906,243	—	—

(1).The historical book value per share for PNAC is calculated by dividing total shareholders’ equity, excluding shares subject to possible redemption, by the number of Class A common stock outstanding at the end of the period.

## FORWARD-LOOKING STATEMENTS

This proxy statement/prospectus includes statements that express PNAC's, PubCo's and noco-noco's opinions, expectations, beliefs, plans, objectives, assumptions or projections regarding future events or future results of operations or financial condition and therefore are, or may be deemed to be, "forward-looking statements." These forward-looking statements can generally be identified by the use of forward-looking terminology, including the terms "believes," "estimates," "anticipates," "expects," "seeks," "projects," "intends," "plans," "may," "will" or "should" or, in each case, their negative or other variations or comparable terminology. These forward-looking statements include all matters that are not historical facts. They appear in a number of places throughout this proxy statement/prospectus and include statements regarding PNAC's, PubCo's and noco-noco's intentions, beliefs or current expectations concerning, among other things, the Business Combination, the benefits and synergies of the Business Combination, including anticipated cost savings, results of operations, financial condition, liquidity, prospects, growth, strategies, future market conditions or economic performance and developments in the capital and credit markets and expected future financial performance, the markets in which noco-noco operates as well as any information concerning possible or assumed future results of operations of the combined company after the consummation of the Business Combination. Such forward-looking statements are based on available current market material and management's expectations, beliefs and forecasts concerning future events impacting PNAC, noco-noco and PubCo. Factors that may impact such forward-looking statements include:

- Developments related to the COVID-19 pandemic, including, among others, with respect to stay-at-home orders, social distancing measures, the success of vaccine rollouts, numbers of COVID-19 cases and the occurrence of new COVID-19 strains that might evade existing control measures and lead to the worsening or extension of adverse economic or movement control measures;
- noco-noco's ability to grow market share in its existing markets or any new markets it may enter;
- noco-noco's ability to execute its growth strategy, manage growth and maintain its corporate culture as it grows;
- noco-noco's ability to successfully execute on acquisitions, integrate acquired businesses and to realize efficiencies or meet growth aspirations inherent in the decision to make a specific acquisition;
- Increased competition in the [electronic vehicle/carbon credit] industry in Singapore, Australia, and Papua New Guinea, the actions of noco-noco's competitors in each of its markets and consequent impact on profitability;
- Changes in noco-noco's business model;
- noco-noco's continued access to certain licensed technologies;
- noco-noco's success in collaborating with its third party research and development partners;
- noco-noco's success in monetizing its technologies;
- The failure to realize anticipated efficiencies through noco-noco's technology and business model;
- Costs associated with enhancements of noco-noco's products or services;
- noco-noco's ability to continue to adjust its offerings to meet market demand, attract users to the noco-noco products or services;
- The regulatory environment and changes in laws, regulations or policies in the jurisdictions in which noco-noco operates;
- Political instability in the jurisdictions in which noco-noco operates;
- The overall economic environment, the property market and general market and economic conditions in the jurisdictions in which noco-noco operates;
- Anticipated technology trends and developments and noco-noco's ability to address those trends and developments with its products and offerings;

- The ability to protect information technology systems and platforms against security breaches (which includes physical and/or cybersecurity breaches either by external actors or rogue employees) or otherwise protect confidential information;
- The safety, affordability, and breadth of the noco-noco's technologies;
- Man-made or natural disasters, including war, acts of international or domestic terrorism, civil disturbances, occurrences of catastrophic events and acts of God such as floods, earthquakes, wildfires, typhoons and other adverse weather and natural conditions that affect noco-noco's business or assets;
- The loss of key personnel and the inability to replace such personnel on a timely basis or on acceptable terms;
- Exchange rate fluctuations;
- Changes in interest rates or rates of inflation;
- Legal, regulatory and other proceedings;
- Tax laws and the interpretation and application thereof by tax authorities in the jurisdictions where noco-noco operates;
- The number and percentage of PNAC stockholders voting against the Business Combination Proposal and the Governing Documents Proposal and/or seeking redemption;
- The occurrence of any event, change or other circumstances that could give rise to the termination of the Business Combination Agreement; and
- PubCo's ability to initially list, and once listed, maintain the listing of its securities on the Nasdaq following the Business Combination.

The forward-looking statements contained in this proxy statement/prospectus are based on PNAC's, noco-noco's and PubCo's current expectations and beliefs concerning future developments and their potential effects on the Business Combination and PubCo. There can be no assurance that future developments affecting PNAC, PubCo and/or noco-noco will be those that PNAC, noco-noco or PubCo has anticipated. These forward-looking statements involve a number of risks, uncertainties (some of which are beyond either PNAC's, PubCo's or noco-noco's control) or other assumptions that may cause actual results or performance to be materially different from those expressed or implied by these forward-looking statements. These risks and uncertainties include, but are not limited to, those factors described under the heading "Risk Factors." Should one or more of these risks or uncertainties materialize, or should any of the assumptions prove incorrect, actual results may vary in material respects from those projected in these forward-looking statements. PNAC, noco-noco and PubCo will not undertake any obligation to update or revise any forward-looking statements, whether as a result of new information, future events or otherwise, except as may be required under applicable securities laws.

Before a shareholder grants its proxy, instructs how its vote should be cast or votes on the Business Combination Proposal, the Governing Documents Proposal or the Adjournment Proposal, it should be aware that the occurrence of the events described in the "Risk Factors" section and elsewhere in this proxy statement/prospectus may adversely affect PNAC, PubCo and/or noco-noco.

## RISK FACTORS

*You should carefully consider the following risk factors, together with all of the other information included in this proxy statement/prospectus, before you decide whether to vote or instruct your vote to be cast to approve the proposals described in this proxy statement/prospectus. Certain of the following risk factors apply to the business and operations of noco-noco and will also apply to the business and operations of PubCo following the completion of the Business Combination. The occurrence of one or more of the events or circumstances described in these risk factors, alone or in combination with other events or circumstances, may adversely affect the ability to complete or realize the anticipated benefits of the Business Combination, and may have a material adverse effect on the business, financial condition, results of operations, prospects and trading price of PubCo following the Business Combination. The risks discussed below may not prove to be exhaustive and are based on certain assumptions made by PubCo, PNAC and noco-noco, which later may prove to be incorrect or incomplete. PubCo, PNAC and noco-noco may face additional risks and uncertainties that are not presently known to such entity, or that are currently deemed immaterial, but which may also ultimately have an adverse effect on any such party.*

### **Risks Related to noco-noco's Business and Industry**

*Unless the context otherwise requires, all references in this subsection to the "Company," "we," "us" or "our" refer to the business of noco-noco and its subsidiaries prior to the consummation of the Business Combination, which will be the business of PubCo and its subsidiaries following the consummation of the Business Combination.*

***We are an early stage company with a history of financial losses and our battery business expects to incur significant expenses and continuing losses for the foreseeable future.***

We are engaged in (i) leasing of battery products, including batteries, BEVs and ESS and (ii) carbon abatement solutions and carbon credit sales. Our battery business incurred a net loss of approximately \$0.7 million and \$1.1 million for the six months ended June 30, 2021 and 2022, respectively, and an accumulated deficit of approximately \$1.3 million and \$2.4 million as of June 30, 2021 and 2022, respectively. As our battery business currently does not have any operations to generate revenue, except revenue generated in 2021 for production of sample batteries used for a client's internal testing for the purpose of providing the Public Utility Board of Singapore with a proof-of-concept ESS, we believe that our battery business will continue to incur operating and net losses each fiscal year until such time as we begin significant production and leasing of our battery products, which is not expected to occur until the third quarter of 2023, and may occur later.

We expect the rate at which we will incur losses to be higher in future periods as we, among other things, continue to expand our footprints in the Southeast Asian and South Asian region, increase our sales and marketing activities, develop our distribution infrastructure, and increase our general and administrative functions to support our growing operations. We may find that these efforts are more expensive than we currently anticipate or that these efforts may not result in revenues, which would further increase our losses or even prevent us from continuing as a going concern.

Further, the battery and EV industries are affected by market conditions that are outside our control. Our results of operations may fluctuate significantly from period to period due to a number of factors, including changes in market demand for batteries, BEVs and ESS, industry-wide technology changes, the loss of key clients and the postponement, rescheduling or cancellation of large orders by key clients. As a result of these factors and other risks discussed in this section, period-to-period comparisons should not be relied upon to predict our future performance.

***Our business model has yet to be tested and any failure to commercialize our strategic plans would have an adverse effect on our operating results and business, harm our reputation and could result in substantial liabilities that exceed our resources.***

Our battery business has not commenced operations yet. Investors should be aware of the difficulties normally encountered by a new enterprise, many of which are beyond our control, including substantial risks and expenses in the course of developing or manufacturing new products or services, establishing or entering new markets, organizing operations, and undertaking marketing activities. The likelihood of our success must be considered in light of these risks, expenses, complications, delays and the competitive environment in which we operate. There is, therefore, nothing at this time upon which to base an assumption that our business plan will prove successful, and we may not be able to generate significant revenue, raise additional capital, or operate profitably. We will continue to encounter risks and difficulties frequently experienced by early commercial stage companies, including introducing products or services that are accepted by the markets, scaling up our infrastructure and headcount, and we may encounter unforeseen expenses, difficulties or delays in connection with our growth. In addition, as a result of the capital-intensive nature of our leasing business, we can be expected to face pressures to raise additional financings in order to sustain our operations of leasing projects to grow our business and achieve profitability. Any investment in our company is therefore highly speculative and could result in the loss of your entire investment.

It is difficult to predict our future revenues and appropriately budget for our expenses, and we have limited insight into potential changes in trends that may emerge and affect our business. In the event that actual results differ from our estimates or we adjust our estimates in future periods, our operating results, prospects and financial position could be materially affected. The projected financial information appearing elsewhere in these materials was prepared by management and reflects current estimates of future performance. The projected results depend on the successful implementation of management's growth strategies and are based on assumptions and events over which we have only partial or no control. In particular, our projected results are heavily reliant on our ability to successfully develop, manufacture, market and lease our battery products. The assumptions underlying such projected information require the exercise of judgment and may not occur, and the projections are subject to uncertainty due to the effects of economic, business, competitive, regulatory, legislative, and political or other changes.

***Our business plan may not prove successful, is subject to legal and regulatory risks and our products may not be well-accepted by the markets, which could materially and adversely affect our prospects.***

Our businesses in Asia-Pacific, including Singapore, Thailand, the Philippines, Indonesia, India, Australia, and PNG, are relatively new, and there is no assurance that we will be able to achieve and maintain growth and profitability across all of our business segments. There is also no assurance that our offerings will be accepted by the market or that market acceptance of our offerings will grow. Further, technologies and industry standards in relation to batteries, BEVs and ESS are evolving. For example, many of our competitors are developing a variety of battery technologies, such as solid state batteries and fuel cells, which are expected to compete with our existing product lines. It is possible that our competitors will be able to introduce new products with more desirable features than ours and their new products will gain greater market acceptance. In addition, our business could be impacted by macro-economic conditions and their effect on discretionary consumer spending, which could impact the business of our prospective consumers and in turn could impact the demand of service offerings made available by us.

Furthermore, we plan to operate our leasing services and carbon abatement solutions in several countries in the large, diverse and complex Asia-Pacific region. Each of our segments is subject to various regulations in each of the jurisdictions in which we operate. Focus areas of regulatory risk that we are exposed to include, among others: (i) evolution of laws and regulations applicable to the leasing of batteries, BEVs and ESS as well as carbon abatement projects and carbon credit sales, (ii) various forms of data regulation such as data privacy, data localization, data portability, cybersecurity and advertising or marketing, (iii) economic regulations such as price, supply regulation, safety, health, environment regulations, (iv) foreign ownership restrictions, (v) vehicle regulation, (vi) land management, and (vii) native title of land. In addition, we may not be able to obtain all the licenses, permits and approvals that may be necessary to provide our product or service offerings. Because the relevant laws and regulations, as well as their interpretations, are often unclear and evolving in certain jurisdictions, this can make it difficult for us to assess whether we have complied with the relevant laws and regulations and which licenses and approvals are necessary for our business, or the processes for obtaining such licenses in certain jurisdictions. For these reasons, we also cannot be certain that we will be able to comply with all the material laws and regulations or maintain the licenses and approvals that we have previously obtained, or that once they expire we will be able to renew them. We cannot be sure that our interpretations of the rules and their exemptions have always been or will be consistent with those of the local regulators. As we expand our businesses, we may be required to obtain new licenses and will be subject to additional laws and regulations in the markets we plan to operate in.

We also expect to expand our businesses in the Asia-Pacific region through acquisitions and strategic partnerships. Such expansion may increase the complexity of our business and may place significant strain on our management, personnel, operations, systems, technical performance, financial resources, and internal financial control and reporting functions. If our efforts of expansion through acquisitions or strategic partnerships fail, our business, results of operations, financial position, reputation, and prospects could be materially adversely affected.

***The success of our business significantly relies on our relationship with 3DOM Alliance. If 3DOM Alliance no longer exclusively licenses its intellectual property rights and technologies to us, our business, financial position, results of operations and prospect would be materially and adversely affected.***

All of our technologies are licensed from 3DOM Alliance, enabling us to utilize certain intellectual property rights and technologies owned or licensed in by 3DOM Alliance to manufacture and offer our own products. See “*noco-noco’s Business—Relationship with 3DOM Alliance*” for more details. We also rely on 3DOM Alliance’s intellectual property rights and technologies to enable the development, operations and improvement of our battery products. Although our license-in agreement with 3DOM Alliance has a perpetual term, 3DOM Alliance can terminate the license-in agreement if we fail to pay any amounts when due with a thirty (30) days’ written notice, or when we fail to perform any obligation and fail to cure within the sixty (60) days notice period. If the license-in agreement is terminated or if we are unable to license future intellectual property rights and technologies from 3DOM Alliance, if we do so only on terms that are less favorable to us, our ability to continue to develop, maintain and improve our battery products and services could be harmed, which could in turn adversely affect our business, financial condition and results of operations. Additionally, some of the technology licensed under the 3DOM Alliance license are sublicensed to us by 3DOM (rather than licensed directly) and if 3DOM were to lose its rights to sublicense such technologies it is possible that we would not be able to use such technologies in the future.

***Our business and future growth depends on the growth in demand for BEVs, hybrid vehicles and alternative fuel.***

As the demand for our products is directly related to the market demand for BEVs, a fast-growing e-mobility market will be critical to the success of our business. In anticipation of an expected increase in the demand for BEVs in the next few years, we have sought long-term strategic partnerships, such as our strategic alliance with EV Dynamics and its Japanese subsidiary. See “*noco-noco’s Business—Partnerships*” for our potential strategic alliance with EV Dynamics. However, the markets we have targeted, primarily those in Asia-Pacific region, may not achieve the level of growth we expect during the time frame projected. If any of these markets that we plan to expand into fails to achieve our expected level of growth, we may incur significant losses and not be able to generate enough revenue to achieve profitability. If the market for alternative fuel, hybrid vehicles and electric vehicles does not develop at the rate or in the manner or to the extent that we expect, or if critical assumptions that we have made regarding the efficiency of our energy solutions are incorrect or incomplete, our business, prospects, financial condition and operating results could be adversely affected.

***The EV battery market continues to evolve and is highly competitive, and other battery manufacturers have significantly greater resources than we do.***

The EV battery market, like the EV market it services, is fast-growing, extremely competitive and driven by the innovation of both large incumbents and emerging entrants like noco-noco. For more information, see “*noco-noco’s Business—Competition*.” Lithium-ion battery technology has been widely adopted and our current competitors have, and future competitors may have, greater resources than we do and may also be able to devote greater resources to the development of their current and future technologies. These competitors also may have greater access to clients and may be able to establish cooperative or strategic relationships amongst themselves or with third parties that may further enhance their resources and competitive positioning. In addition, lithium-ion battery manufacturers may continue to reduce cost and expand supply of conventional batteries and, therefore reducing the prospects for our business or negatively impacting our ability to provide our products at a market-competitive price and with sufficient margins.

To date, we have focused our efforts on our state-of-the-art X-SEPA separator and lithium manganese iron phosphate (LMFP) cathode. However, a number of development-stage companies are also seeking to develop new technologies for lithium-metal batteries, such as new technologies for cathodes, anodes, electrolytes and additives. Some of these companies have established relationships with OEMs and are in varying stages of development. Additionally, many OEMs are researching and investing in conventional lithium-ion batteries and/or lithium-metal battery efforts and, in some cases, in battery development and production. Furthermore, other companies are developing alternative technologies such as advanced diesel, ethanol, fuel cells or compressed natural gas, as well as potential improvements in the fuel economy of the internal combustion engine. We expect competition in battery technology and BEVs to intensify due to increased demand for EVs. Competition may also be driven by a regulatory push for EVs, continuing globalization, and consolidation in the worldwide automotive industry. Developments in alternative technologies or improvements in battery technology made by competitors may materially adversely affect the sales, pricing and gross margins of our battery products. If a competing technology is developed that has superior operational or price performance, our business will be harmed. Similarly, if we fail to accurately predict and ensure that our battery technology can address clients’ changing needs or emerging technological trends, or if our clients fail to achieve the benefits expected from our battery products, our business will be harmed.

***Our future success depends on the needs and success of our clients, as well as the demand for our clients' products or services.***

The demand for our battery products, in particular the batteries and BEVs, will ultimately depend on our clients, consisting primarily of commercial transportation companies, renewable energy plants and power plants. Decisions to purchase or lease our batteries and BEVs may depend on the performance of the industries of our clients and if demand for output in those industries decreases, then the demand for our products may decrease as well. Demand in these industries is impacted by numerous factors, including, but not limited to, commodity prices, infrastructure spending, fuel costs, energy demands, municipal spending and government mandates and incentives. Increases or decreases in these variables may significantly impact the demand for our products.

***Many of our target clients are large commercial transportation companies, renewable energy plants and power plants, and the failure to maintain existing clients and secure new clients, withdrawal of leasing services by such clients or failure to negotiate acceptable terms in contract renewal negotiations could have an adverse impact on our business.***

Although we intend to lease predominantly to commercial transportation companies, renewable energy plants and power plants, we may not be able to establish or continue our relationships with such commercial transportation companies, renewable energy plants or power plants, if customer demand is not as high as we expect or if they face pressure or contractual obligations from their existing suppliers not to purchase our products or services. We may enter into long-term contracts with certain of these commercial transportation companies, renewable energy plants and power plants, who have substantial bargaining power with respect to price and other commercial terms, and any long-term contracts would be subject to renegotiation and renewal from time to time. Failure to maintain existing clients, obtain new clients, loss of all or a substantial portion of sales to any future clients for whatever reason (including, but not limited to, loss of contracts or failure to negotiate acceptable terms in contract renewal negotiations, loss of market share by these clients, insolvency of such clients, reduced or delayed client requirements, plant shutdowns, strikes or other work stoppages affecting production by such clients) or continued reduction of prices to these clients could have a significant adverse effect on our financial results and business prospects. There can be no assurance that we will be able to maintain existing clients, obtain new clients or secure new contracts.

The level of any future leasing to commercial transportation companies, renewable energy plants and power plants, including the realization of future leasing services from awarded business or obtaining new business or clients, is inherently subject to a number of risks and uncertainties, including the number of vehicles, energy storage or grid stabilization that these commercial transportation companies, renewable energy plants and power plants actually need. Further, to the extent that the financial condition, including bankruptcy or market share, of any of our largest clients deteriorates or their sales otherwise continue to decline, our business, prospects, financial condition and operating results could be adversely affected. Accordingly, we may not in fact realize all of the future sales represented by our awarded business. Any failure to realize these sales could have a material adverse effect on our business, prospects, financial condition and operating results.

***We may not be able to engage target clients successfully and to convert such contacts into meaningful orders in the future.***

Our success, and our ability to increase revenue and operate profitably, depends in part on our ability to identify target clients and convert target clients into meaningful orders or expand on client relationships. In some cases, certain clients will purchase our battery product samples on an early trial deployment basis, where such clients have the ability to test and evaluate whether our products meet their performance requirements before such clients commit to meaningful orders.

Our future success depends on whether our target clients are willing to use our battery products as well as whether their product lines will incorporate our battery products. If our target clients expand their product lines, we hope to be the primary supplier for their BEVs. Competition in our industry is high. To secure acceptance of our products, we must constantly develop and introduce longer-range and more cost-effective batteries with enhanced functionality and performance to meet evolving industry standards. If we are unable to meet our clients' performance requirements or industry specifications, retain or engage with target clients, or convert early trial deployments into meaningful orders, our business, prospects, financial condition and operating results could be materially adversely affected.

***If we are unable to establish and maintain confidence in our long-term business prospects among clients and analysts and within our industry or are subject to negative publicity, then our financial condition, operating results, business prospects and access to capital may suffer materially.***

Clients may be less likely to purchase our battery products if they are not convinced that our business will succeed or that our service and support and other operations will continue in the long term. Similarly, suppliers and other third parties will be less likely to invest time and resources in developing business relationships with us if they are not convinced that our business will succeed. Accordingly, in order to build and maintain our business, we must earn and maintain confidence among clients, suppliers, analysts, ratings agencies and other parties in our products, long-term financial viability and business prospects. Maintaining such confidence may be particularly complicated by certain factors including those that are largely outside of our control, such as our limited operating history, client unfamiliarity with our battery products, any delays in scaling production, delivery and service operations to meet demand, competition, future changes in the evolving hybrid electric and electric vehicle market or uncertainty regarding our production and sales performance compared with market expectations.

***If any of our battery products fails to perform as expected, our ability to develop, market and sell our products and services could be harmed.***

Our battery products, such as our batteries, BEVs, and ESS, could contain defects in design and production that may cause them not to perform as expected or may require repair. We currently have a limited frame of reference by which to evaluate the performance of our products upon which our business prospects depend. There can be no assurance that we will be able to detect and fix any defects in our battery products. We may experience recalls in the future, which could adversely affect our brand and could adversely affect our business, prospects, financial condition and operating results.

Further, our products may not perform consistent with clients' expectations. Any product defects or any other failure of our battery products to perform as expected could harm our reputation and result in lost revenue, delivery delays, product recalls, negative publicity, product liability claims and significant warranty and other expenses and could have a material adverse impact on our business, prospects, financial condition and operating results. Additionally, problems and defects experienced by alternative fuel commercial vehicle companies or electric consumer vehicles could by association have a negative impact on public perception and customer demand for our products.

***Our battery products will require extensive safety testing prior to being offered to our lessees or installed in electric vehicles and power plants.***

To achieve acceptance by our clients, including lessees, and power producers, our anticipated batteries, BEVs and ESS will have to undergo extensive safety testing. We plan to conduct preliminary safety testing for design verification of our battery products at their prototype stage. We are also subject to safety tests for product validation to obtain various safety standard certifications before commencing mass production of our battery products. There can be no assurance that such tests will be successful, and we may identify different or new safety issues in our development or manufacturing of the batteries, BEVs and ESS that have not been present in our prototypes. If we have to make design changes to address any safety issues, we may have to delay or suspend commercialization, which could materially damage our business, prospects, financial condition, operating results and brand.



***Any decline in the value of carbon credits or carbon offsets could materially adversely affect our business.***

The value of carbon credits and carbon offsets fluctuate based on market, standard-setting and regulatory forces outside our control. Although the value of carbon credits and carbon offsets has been rising in recent years, new technologies or easier carbon credit or carbon offset issuance rules, for example, may facilitate an increase in the supply of carbon credits and carbon offsets that outstrips demand, resulting in the value of carbon credits and carbon offsets to decline. Any such decline could mean demand and pricing for our carbon credit supply offerings would be adversely affected. Apart from supply and demand, the carbon credits prices may also be impacted by micro- and macro-economic conditions, general economic sentiment, international mandates, geopolitical tension, technology enhancements, inflation and currency exchange rates. Any decline in the value of carbon credits or carbon offsets could materially and adversely affect our business, results of operations and financial condition.

***Changes in industry standards or practices for issuance or usage of carbon credits or carbon offsets could significantly adversely affect our business.***

The issuance and verification procedures, and the recommended usage, for carbon credits or carbon offsets are evolving areas. Changes in these areas could materially and adversely impact our business. Should, for example, issuance standards change such that our carbon-focused projects are not able to issue as many carbon credits or carbon offsets as projected, our available carbon credit pool will decline which will materially negatively impact our business. The demand side of the carbon credit markets are driven by a combination of industry standards and generally accepted practices and regulations. Should industry practices or recommendations change, or the regulatory environment change, there could be a potentially material and adverse effect on our business.

***If verified and available carbon sequestration or carbon credits or carbon offsets are lower than projected, our business could be materially adversely affected.***

We may make estimates on future carbon potential for our carbon abatement projects, specifically including nature-based projects such as reforestation (or other similar projects such as changes in soil or land management). We may rely on these and other generally available estimates for making carbon neutrality calculations, tree planting commitments and/or carbon credits sales or carbon offsets. If the actual realized carbon sequestration differs from our estimates due to factors, such as differences in survival rates or measured carbon sequestration, or changes in verification methodologies, standards, or changes in required buffer pools (including by third-party verification organizations), fewer carbon sequestration, carbon credits or carbon offsets may be realized and available, which could negatively impact our business and profitability as carbon credits and carbon offsets earned by us may be reduced and we may be required to purchase carbon credits at prevailing market rates.

***We cannot guarantee that the approvals of the carbon abatement projects and issuing of Australian Carbon Credit Units (“ACCUs”) will not be revoked, cancelled or otherwise.***

We operate our carbon abatement solutions in a variety of Oceanian countries, including Australia and PNG. In Australia, the carbon abatement projects and the issuing of ACCUs are subject to the approvals and regulation of the Australian government and in particular, the Clean Energy Regulator (the “CER”). Prior to issuing ACCUs, the CER reviews and considers applications for approved projects. See “*Business—Government Regulations.*” We cannot guarantee that such approvals and issuing of ACCUs will not be revoked, cancelled or otherwise negatively impacted, in which case our business could be materially adversely affected.

Furthermore, the regulatory bodies may impose further compliance procedures and protocols on our existing or future projects. Any such procedures or protocols will require us to adopt and incorporate any amendments to ensure full and complete compliance of law and regulations. This may result in the delay of carrying out our existing projects, and may also impact the development of our future business activities. The regulation of the ACCUs is subject to government policy changes, and we cannot guarantee that our current business activities will not be impacted by any future amendments to laws and regulations governing the carbon abatement industry.

***If we cannot acquire all interested parties' consent for the carbon abatement projects, or if there is any deficiency in the ownership interests in the properties of the projects, our business could be materially adversely affected.***

The carbon abatement project procurement stage may involve several parties with varying interests, which mainly includes landowners, but sometimes also a bank or a lending institution if there is a mortgage on the property to obtain consent or a "no objection certificate" from the lender to file and obtain carbon credits. For certain carbon abatement projects, we may not only need to obtain consent from a single landowner but multiple landowners to tie up contiguous land parcels for carrying out such projects. When we negotiate with the interested parties, we cannot guarantee that we are able to acquire the consent from all of them. If we are not able to do so, the projects will not be carried out according to the planned timetable, and our business could be materially adversely affected. In addition, if there is any deficiency or controversy in the title or ownership of any property which is the subject of a carbon abatement project, we will need to seek to ensure our legitimate business interests are protected, which may result in limiting the resources being applied to our business activities. Furthermore, if we are unsuccessful in protecting our legitimate business interests, our business operations could be materially adversely affected.

***Any non-compliance of the landowners on their contractual obligations may affect our carbon abatement solutions business.***

Due to the growth of our carbon abatement projects requiring large areas of land, access to land is an integral part of our business activities. In particular, unrestricted access to use and control the land is important to maintain and further our business activities. However, we are generally not the registered owner of any real property, and entirely rely on the licenses and/or agreements in place with the registered landowners and their compliance with their respective contractual obligations. If the landowners do not have valid licenses or approvals, or do not comply with legal requirements or contractual obligations, we may not be able to maintain the necessary rights required for our business activities and therefore it could affect our business operations.

***We may not succeed in establishing, maintaining and strengthening our brand, which would materially and adversely affect client acceptance of our technologies and our business, revenues and prospects.***

Our business and prospects depend on our ability to develop, maintain and strengthen our brand. If we are not able to establish, maintain and strengthen our brand, we may lose the opportunity to build a critical mass of clients. The battery and EV industry is intensely competitive, and we may not be successful in building, maintaining and strengthening our brand. Our potential competitors, including many battery manufacturers and automotive OEMs around the world, have greater name recognition, broader client relationships and substantially greater marketing resources than we do. If we do not develop and maintain a strong brand, our business, prospects, financial condition and operating results will be materially and adversely impacted.

***We operate in an extremely competitive industry and are subject to pricing pressures. Further, many other battery manufacturers have significantly greater resources than we do.***

We compete with a number of major international manufacturers and distributors, as well as a number of smaller, regional competitors. We expect competition to become more intense as zero-emission transportation is becoming the mainstream with an increasing number of participants in the industry. Increased competition may result in declines in average selling prices, causing a decrease in margins. Due to excess capacity in some sectors of our industry and consolidation among industrial battery purchasers, we may be subjected to significant pricing pressures.

Many of our competitors have greater financial, personnel, technical, manufacturing, marketing, sales and other resources than we do, which may place us at a competitive disadvantage. In addition, certain of our competitors may have a lower overall cost structure. As a result, these competitors may be in a stronger position to respond quickly to market opportunities, new or emerging technologies and evolving industry standards. Many of our competitors are developing a variety of battery technologies, such as solid state batteries and fuel cell, which are expected to compete with our existing product lines. It is possible that our competitors will be able to introduce new products with more desirable features than ours and their new products will gain greater market acceptance. If our competitors successfully do so, we may not be able to maintain our competitive position and our business and future success would be materially and adversely affected.

We anticipate continued competitive pricing pressure as other producers may be able to employ labor at significantly lower costs, expand their export capacity and increase their marketing presence in our major end markets. Several of our competitors have strong technical, marketing, sales, manufacturing, distribution and other resources, as well as significant name recognition, established positions in the market and long-standing relationships with our industry's potential client base. In addition, certain of our competitors may have long-standing relationships with suppliers, which may provide them with a competitive pricing advantage and reduce their exposure to volatile raw material costs. Our ability to maintain and improve our operating margins has depended, and continues to depend, on our ability to control and reduce our costs. We cannot assure you that we will be able to continue to control our operating expenses, to raise or maintain our prices or increase our unit volume, in order to maintain or improve our operating results.

***The uncertainty in global economic conditions could negatively affect our operating results.***

Our operating results are directly affected by the general global economic conditions of the industries in which our major client groups operate. Our business segments are highly dependent on the economic and market conditions in each of the geographic areas in which we operate. Leasing of our batteries, BEVs and ESS, for example, depend significantly on demand for new electric vehicle transportation or ride-sharing companies. The uncertainty in global economic conditions varies by geographic segment and can result in substantial volatility in global credit markets. These conditions affect our business by reducing prices that our clients may be able or willing to pay for our products or by reducing the demand for our products, which could in turn negatively impact our sales and result in a material adverse effect on our business, cash flow, results of operations and financial condition.

***Substantial increases in the prices for our raw materials and components, some of which are obtained from a limited number of sources where demand may exceed supply, could materially and adversely affect our business.***

We rely on third-party suppliers for components and equipment necessary to develop our products, including key supplies, such as polyimide substrate, organic beads, LMFP cathode material and separator manufacturing machine, for our battery products. We face risks relating to the availability of these materials and components, including that we will be subject to demand shortages and supply chain challenges, especially in the context of the current COVID-19 pandemic, and generally may not have sufficient purchasing power to eliminate the risk of price increases for the raw materials and tools we need. Further, certain components, including drying furnace, 3-layer die, charging and discharging equipment, IC chips and CPUs, have a long lead time which require us to order well in advance to support our proposed commercial operations. To mitigate the supply chain risks, we are adopting an all-round strategy of collaborating with many automaker partners and OEM suppliers. However, to the extent that we are unable to enter into commercial agreements with our prospective suppliers or our replacement suppliers on favorable terms, or these suppliers experience difficulties meeting our requirements, the development and commercial progression of our battery products and related technologies may be delayed.

Separately, we may be subject to various supply chain requirements regarding, among other things, conflict minerals and labor practices. We may be required to incur substantial costs to comply with these requirements, which may include locating new suppliers if certain issues are discovered. We may not be able to find any new suppliers for certain raw materials or components required for our operations, or such suppliers may be unwilling or unable to provide us with products.

Any disruption in the supply of components, equipment or materials could temporarily disrupt production of our battery product until an alternative supplier is able to supply the required material. Changes in business conditions, unforeseen circumstances, governmental changes, and other factors beyond our control or which we do not presently anticipate, could also affect our suppliers' ability to deliver components or equipment to us on a timely basis. Any of the foregoing could materially and adversely affect our results of operations, financial condition and prospects.

Currency fluctuations, trade barriers, tariffs or shortages and other general economic or political conditions may limit our ability to obtain key components or equipment for our battery products or significantly increase freight charges, raw material costs and other expenses associated with our business, which could further materially and adversely affect our results of operations, financial condition and prospects.

***Entering into strategic alliances could expose us to risks.***

We have entered into several memorandums of understanding (“MOUs”) for, and may in the future enter into additional, strategic alliances, including joint ventures or minority equity investments, with various third parties to further our business. For example, on November 14, 2022, we entered into a MOU with a view to joining forces with EV Dynamics to form a joint venture. See “*noco-noco’s Business—Partnerships*” for more details. Our strategic alliance with EV Dynamics will allow us to carry out a carbon-free bus leasing business to EV Dynamics’ existing clients as well as other new clients.

While offering potential benefits, these strategic alliances could subject us to a number of risks, including risks associated with sharing proprietary information, non-performance by the partners and increased expenses in establishing new strategic alliances, any of which may materially and adversely affect our business. We may have limited ability to monitor or control the actions of these partners and, to the extent any of these strategic partners suffers negative publicity or harm to their reputation from events relating to their business, we may also suffer negative publicity or harm to our reputation by virtue of our association with any such partner. For example, if we rely on certain strategic partner’s manufacturing facilities to produce our battery products, those operations would be outside of our control. We could experience delays if our partners do not meet agreed upon timelines, satisfy legal, industry or our client’s requirements, or experience capacity constraints, and in turn, we could lose clients and face reputational harm.

Further, there is risk of potential disputes with the strategic partners, and we could be affected by adverse publicity related to our partners whether or not such publicity is related to their collaboration with us. Our ability to successfully build a premium brand could also be adversely affected by perceptions about the quality of our partners’ products. Our OEM partners may also have economic, business, or legal interests or goals that are inconsistent with ours. As a result, it may be challenging for us to resolve issues that arise in respect of the performance of our agreements or MOUs with them, and such issues might impact development work underway under the agreements or MOUs.

Any significant disagreements with them, and especially if we become dependent on that OEM partner for our research and development efforts, may impede our ability to maximize the benefits of our partnerships and slow the commercial roll-out of our battery products. In addition, if our partners are unable or unwilling to meet their economic or other obligations under the agreements or MOUs, we may be required to fulfill those obligations alone, which could delay research and development progress and otherwise negatively impact our business and financial results. Furthermore, the relationships we have with our existing partners and the rights our partners have under their respective agreements or MOUs, may deter other OEMs from working with us. If we are not able to establish or expand our partnership with other OEMs, our business and prospects could be materially harmed.

***We are dependent on our suppliers to fulfill our clients’ orders, and if we fail to manage our relationships effectively with, or lose the services of, these suppliers and cannot substitute suitable alternative suppliers, our operations would be materially adversely affected.***

We rely on our suppliers for the provision of raw materials, automaker partners and OEM suppliers for the manufacturing of our battery products, including battery separators, cells and packs, BEVs and ESS. While we plan to engage multiple suppliers, automakers and OEMs whenever possible, the inability of our suppliers to deliver the raw materials and battery products manufactured by them at prices, volumes, performance and specifications acceptable to us could have a material adverse effect on our business, prospects, financial condition and operating results. In addition, because we rely on our suppliers and partners to provide raw materials or manufacture battery products that meet our quality standards, there can be no assurance that we can successfully receive quality materials or products from our suppliers and partners that satisfy our quality standards. Any of the foregoing could adversely affect our business, results of operations, financial condition and prospects.

***Our failure to keep up with rapid technological changes and evolving industry standards may cause our products to become obsolete and less marketable.***

The battery market is characterized by changing technologies and evolving industry standards, which are difficult to predict. This, coupled with frequent introduction of new products and models, has shortened product life cycles and may render our products obsolete or unmarketable. Our ability to adapt to evolving industry standards and anticipate future standards and market trends will be a significant factor in maintaining and improving our prospects for growth. R&D activities, however, are inherently uncertain and require significant costs, and we might encounter practical difficulties in commercializing our new technologies licensed from 3DOM Alliance. On the other hand, our competitors may improve their technologies or even achieve technological breakthroughs that would render our products obsolete or less marketable. Therefore, our failure to effectively keep up with rapid technological changes and evolving industry standards by introducing new and enhanced products may cause us to lose our clients and to suffer a decrease in our revenue.

***If we cannot continue to develop new products in a timely manner and at favorable margins, we may not be able to compete effectively.***

The battery industry has been notable for the pace of innovations in product life, product design and applied technology. We and our competitors have made and continue to make, investments in innovating and improving our products. Our ability to create new products and line extensions and to sustain existing products is affected by whether we can, among other things:

- license-in on favorable terms and maintain innovative intellectual property and technologies from 3DOM Alliance and its licensors;
- obtain governmental approvals and registrations;
- comply with governmental regulations; and
- anticipate client needs and preferences successfully.

The failure to develop and launch successful new products and any delay in the development or launch of a new product could hinder the growth of our business. In addition, if competitors introduce new or enhanced products that significantly outperform ours, or if they develop or apply manufacturing technology that permits them to manufacture at a significantly lower cost relative to ours, we may be unable to compete successfully in the market segments affected by these changes.

***We may obtain licenses on technology that has not been commercialized or has been commercialized only to a limited extent, and the success of our business may be adversely affected if such technology does not perform as expected.***

From time to time, we may license from third parties, including 3DOM Alliance, technologies that have not been commercialized or which have been commercialized only to a limited extent. These technologies may not perform as expected within the markets for our battery products. If the cost, performance characteristics, manufacturing process or other specifications of these licensed technologies fall short of our targets, our projected sales, costs, time to market, future product pricing and potential operating margins may be adversely affected.

***Developments in alternative technology may adversely affect the demand for our battery products.***

Significant developments in alternative technologies, such as advanced diesel, ethanol or natural gas, or breathing batteries, may materially and adversely affect our business, prospects, financial condition and operating results in ways that we may not currently anticipate. Existing and other battery technologies, fuels or sources of energy may emerge as clients' preferred alternatives to our battery products. Any failure by us to develop new or enhanced technologies or processes, or to react to changes in existing technologies, could materially delay our development and introduction of new and enhanced alternative products, which could result in decreased revenue and a loss of market share to our competitors.

We rely on 3DOM Alliance's R&D efforts which may not be sufficient to adapt to changes in alternative fuel and electric vehicle technology. As technologies evolve, we will need to upgrade or adapt our clean energy solutions with the latest technology, in particular our licensed-in long-life battery technology, and developing intelligent battery systems with CPUs and IoT devices attached, in order to leverage on our own-and-lease model. However, we may not compete effectively with alternative systems if we are not able to source and integrate the latest technology into our battery products.

***Our products could have undetected defects, errors or bugs in hardware, firmware or software, which could reduce market adoption, damage our reputation with prospective clients, and/or expose us to product liability and other claims that could materially and adversely affect our business.***

We may be subject to claims that our products have malfunctioned and persons were injured or purported to be injured due to latent defects. Any insurance that we carry may not be sufficient or it may not apply to all situations. Similarly, to the extent that such malfunctions are related to components obtained from third-party vendors, such vendors may not assume responsibility for such malfunctions. Any of these events could adversely affect our brand, reputation, financial condition or results of operations.

Any defects or errors in product or services offerings, or the perception of such defects or errors, or other performance problems could result in any of the following, each of which could adversely affect our business and results of operations:

- expenditure of significant financial and product development resources, including recalls, in efforts to analyze, correct, eliminate or work around errors or defects;
- loss of existing or potential clients or partners;
- interruptions or delays in sales;
- equipment replacements;
- delayed or lost revenue;
- delay or failure to attain market acceptance;
- delay in the development or release of new functionality or improvements;
- negative publicity and reputational harm;
- sales credits or refunds;
- exposure of confidential or proprietary information;
- diversion of development and client service resources;
- breach of warranty claims;
- legal claims under applicable laws, rules and regulations; and
- the expense and risk of litigation.

We also face the risk that any contractual protections we seek to include in our agreements with clients are rejected, not implemented uniformly or may not fully or effectively protect from claims by clients, business partners or other third parties. In addition, any insurance coverage or indemnification obligations of suppliers for our benefit may not adequately cover all such claims, or cover only a portion of such claims. A successful product liability, warranty, or other similar claim could have an adverse effect on our business, financial condition and results of operations. In addition, even claims that ultimately are unsuccessful could result in expenditure of funds in litigation, divert management's time and other resources and cause reputational harm.

***We are subject to risks relating to production scale manufacturing of our battery products, including battery separators, cells and packs, BEVs and ESS through partners in the longer term.***

Our business plan contemplates that automakers and OEMs will manufacture our battery products, including battery separators, cells and packs, BEVs, and ESS, using our unique pre-calculated and calibrated manufacturing process. However, modifying or constructing these lines for production of our products could be more complicated or present significant challenges to our manufacturing partners that we do not currently anticipate. As with any large-scale capital project, any modification or construction of this nature could be subject to delays, cost overruns or other complications. Any failure to commence commercial production on schedule likely would lead to additional costs and could delay our ability to generate meaningful revenues. In addition, any such delay could diminish any "first mover" advantage we aim to attain, prevent us from gaining the confidence of OEMs and open the door to increased competition. All of the foregoing could hinder our ability to successfully launch and grow our business and achieve a competitive position in the market.

Further, collaboration with third parties to manufacture our battery products reduces our level of control over the process. We could experience delays if our partners do not meet agreed upon timelines or experience capacity constraints. There is risk of potential disputes with partners, which could stop or slow production, and we could be affected by adverse publicity related to our partners, whether or not such publicity is related to such third parties' collaboration with us. In addition, we cannot guarantee that our suppliers will not deviate from agreed-upon quality standards.

We may be unable to enter into agreements with manufacturers on terms and conditions acceptable to us and therefore we may need to contract with other third parties or create our own commercial production capacity. We may not be able to engage other third parties or establish or expand our own production capacity to meet our needs on acceptable terms, or at all. The expense and time required to adequately complete any transition may be greater than anticipated. Any of the foregoing could adversely affect our business, results of operations, financial condition and prospects.

***Manufacturing or use of our products may cause accidents, which could result in significant production interruption, delay or claims for substantial damages.***

Due to the high energy density inherent in lithium-based batteries, our batteries can pose certain safety risks, including the risk of fire or explosion. Our battery risk management system provides early warning signals of battery faults or malfunction, but accidents causing death or personal injury or property damage can still occur. Although safety procedures is also incorporated in the research, development, manufacture and transportation of batteries that are designed to minimize safety risks, the manufacture or use of our products may still cause accidents. Any accident, whether occurring at the manufacturing facilities or from the use of our products, may result in significant production interruption, delays or claims for substantial damages caused by personal injuries or property damage.

***We are subject to regulations regarding the storage and handling of various products. We may become subject to product liability claims, which could harm our financial condition and liquidity if we are not able to successfully defend or insure against such claims.***

We may become subject to product liability claims which could harm our business, prospects, operating results, and financial condition. We face inherent risk of exposure to claims in the event our batteries do not perform as expected or malfunction resulting in personal injury or death. Our risks in this area are particularly pronounced given our X SEPA separator and lithium manganese iron phosphate (LMFP) cathode are still in the development stage and have not yet been commercially mass produced. A successful product liability claim against us could require us to pay a substantial monetary award. Moreover, a product liability claim could generate substantial negative publicity about our technology and business and inhibit or prevent commercialization of our battery products and future product candidates, which would have a material adverse effect on our brand, business, prospects and operating results. Any insurance coverage might not be sufficient to cover all potential product liability claims. Any lawsuit seeking significant monetary damages either in excess of our coverage, or outside of our coverage, may have a material adverse effect on our reputation, business and financial condition. We may not be able to secure product liability insurance coverage on commercially acceptable terms or at reasonable costs when needed.

***Our BEVs and our batteries as components of BEVs are subject to motor vehicle standards and the failure of the vehicles to satisfy such mandated safety standards could have a material adverse effect on the demand for our products, our business and our operating results.***

All vehicles and batteries installed in the vehicles sold or leased must comply with applicable international and local motor vehicle safety standards, which vary by national and local jurisdictions. Rigorous testing and the use of approved materials and equipment are among the requirements for achieving certain mandatory certifications. Failure by our vehicle manufacturing clients to satisfy motor vehicle standards could have a material adverse effect on our business and operating results.

Moreover, we may incur our own significant costs in complying with these regulations. Regulations related to the electric vehicle industry and alternative energy are currently evolving and we face risks associated with the application of these regulations and changes to these regulations.

To the extent the laws become more stringent or otherwise change, our BEVs and/or our batteries may not comply with applicable international or local laws, which would have an adverse effect on our business. Compliance with changing regulations could be burdensome, time consuming, and expensive. To the extent compliance with new regulations is cost prohibitive, our business, prospects, financial condition and operating results would be adversely affected.

There may be laws in jurisdictions we have not yet entered or laws of which we are unaware in jurisdictions we have entered that may restrict our sales or other business practices. Even for those jurisdictions we have analyzed, the laws in this area can be complex, difficult to interpret and may change over time. Continued regulatory limitations and other obstacles interfering with our or our client's ability to sell products could have a negative and material impact on our business, prospects, financial condition and results of operations.

***Future product recalls could materially adversely affect our business, prospects, financial condition and operating results.***

Any product recall in the future, whether it involves our or a competitor's product, may result in negative publicity, damage our brand and materially adversely affect our business, prospects, financial condition and operating results. In the future, we may voluntarily or involuntarily, initiate a recall if any of our products that are proven or possibly could be defective or noncompliant with applicable federal motor vehicle safety standards. Such recalls involve significant expense and diversion of management attention and other resources, which could adversely affect our brand image, as well as our business, prospects, financial condition and operating results.

***We were granted the exclusive license on certain patents and other pending patent applications from 3DOM Alliance pursuant to a license-in agreement entered into on November 22, 2022. The pending patent applications under such license-in agreement may not result in issued patents and the licensed patents may be invalidated or narrowly interpreted, in which event our competitiveness and value may be undermined.***

Our key technological innovations, including innovations that are currently commercialized in our products and innovations that we plan to deploy in the future, are described in numerous issued patents and pending patent applications that we licensed from 3DOM Alliance. There is no assurance that the pending applications will result in issued patents. Further, we cannot guarantee that our use of these patents and associated inventions will not infringe upon rights of third parties. Also, to the extent that we endeavor to enforce our currently issued licensed patents or any patents that will be issued in the future, an alleged infringer may be able to assert that it has not infringed any claim of the applicable patent(s) and that the applicable patent(s) is in any event invalid or unenforceable. There can be no assurance that we will overcome those defenses. Further, if one or more of our patents are held to be invalid or unenforceable, or if claims of those patents are interpreted narrowly, or if patents fail to issue from our pending applications, our competitiveness and value may be undermined.

***We rely heavily on the exclusively-licensed intellectual properties and technologies, which includes patent rights, trade secrets, trademarks, and know-how. If we are unable to protect and maintain access to these intellectual property rights, our business and competitive position would be harmed.***

We may not be able to prevent unauthorized use of our exclusively-licensed intellectual property, which could harm our business and competitive position. We rely on a combination of the intellectual property protections afforded by patent, trademark and trade secret laws in Japan, Singapore and other jurisdictions, as well as license agreements and other contractual protections, to establish, maintain and enforce rights and competitive advantage in our licensed-in technologies. Third parties, including our business partners, may attempt to copy or otherwise obtain and use our intellectual property without our consent or may decline to license or defend necessary intellectual property rights to us on terms favorable to our business. Third parties may also attempt to challenge our use of certain intellectual property rights, particularly in countries where we do not hold patent rights. Monitoring unauthorized use of our intellectual property is difficult and costly, and the steps we have taken or will take to prevent misappropriation may not be sufficient. Any enforcement efforts we undertake, including litigation, could require involvement of the licensor, be time-consuming and expensive, and could divert management's attention, all of which could harm our business, results of operations and financial condition. In addition, existing intellectual property laws and contractual remedies may afford less protection than needed to safeguard our licensed-in technologies. All of our patent rights have been obtained through an exclusive license-in agreement from 3DOM Alliance. Because we do not own those patent rights, we have less control over their validity, maintenance and enforcement, which could harm our ability to maintain any competitive advantage those patent rights provide.



Any registrations for the intellectual property rights we own or license are constrained to the country in which the rights were issued or obtained. Many of the patents we license are not yet registered and are currently under review by the respective patent offices. Our efforts to protect against the unauthorized use of our intellectual property rights, technology and other licensed-in rights in those countries where our intellectual property is under review or not registered may be impossible. With respect to jurisdictions where our intellectual property is already registered, patent, copyright, trademark and trade secret laws vary significantly throughout the world. A number of foreign countries do not protect intellectual property rights to the same extent as Japan and Singapore. Therefore, our intellectual property rights may not be as strong or as easily enforced in some foreign countries, and efforts to protect against the unauthorized use of our intellectual property rights, technology and other licensed-in rights may be impossible in those countries. Failure to adequately protect or be able to use our exclusively-licensed intellectual property rights could result in our competitors using our intellectual property to offer products, potentially resulting in the loss of some of our competitive advantage, a decrease in our revenue and reputational harm caused by inferior products offered by third parties, which would adversely affect our business, prospects, financial condition and operating results.

***We are unable to guarantee that our technology, or its ultimate integration into electric vehicle battery packs, does not infringe intellectual property rights of third parties. We may need to defend ourselves against intellectual property infringement claims, which may be time-consuming and could cause us to incur substantial costs.***

Companies, organizations or individuals, including our current and future competitors, may hold or obtain patents, trademarks or other proprietary rights that would prevent, limit or interfere with our ability to make, use, develop, sell, license, lease or market our products or technologies, which could make it more difficult for us to operate our business. From time to time, we may receive inquiries from third parties relating to whether we are infringing their intellectual property rights and/or seek court declarations that they do not infringe upon our intellectual property rights. Companies holding patents or other intellectual property rights relating to batteries may bring suits alleging infringement of such rights or otherwise asserting their rights and seeking licenses. In addition, if we are determined to have infringed upon a third party's intellectual property rights, we may be required to do one or more of the following:

- cease selling, leasing, incorporating or using products that incorporate the challenged intellectual property;
- pay substantial damages;
- materially alter our research and development activities and proposed production processes;
- obtain a license from the holder of the infringed intellectual property right, which may not be available on reasonable terms or at all; or
- redesign our battery cells at significant expense.

In the event of a successful claim of infringement against us and our failure or inability to obtain a license to continue to use the technology on reasonable terms, our business, prospects, operating results and financial condition could be materially adversely affected. In addition, any litigation or claims, whether or not well-founded, could result in substantial costs, negative publicity, reputational harm and diversion of resources and management's attention.

***Third-party claims or litigation alleging infringement of patents or infringement or misappropriation of other proprietary rights, or seeking to invalidate our patents may adversely affect our business.***

Our success depends in part on our avoiding infringement, misappropriation and other violations of the patents and other intellectual property rights of third parties. Claims of infringement, misappropriation, or other violation of patents or other intellectual property rights are often expensive and time-consuming to defend, and if we were unsuccessful in defense of such claims we could be forced to stop use of certain technologies and/or pay damages or on-going royalties. It is possible that at any time third-parties could attempt to assert an infringement or misappropriation claims if they believe our technology violates their intellectual property rights.

Some of our competitors may have more resources than we do to pursue claims of infringement or misappropriation. We may conclude that even if they are infringing our patents or other intellectual property rights, the risk-adjusted costs of bringing claims against them may be too high or otherwise not in your interest.

***If we are unable to grow, or if we fail to manage future growth effectively, our revenue may not increase and we may be unable to implement our business strategy.***

Our future success depends upon our ability to grow, and if we are unable to manage our growth effectively, we may incur unexpected expenses and be unable to meet our clients' requirements, all of which could materially adversely affect our business, financial condition and results of operations. To manage our current and anticipated future growth effectively, we must continue to maintain and enhance our infrastructure, financial and accounting systems and controls. We must also attract, train and retain a significant number of engineers, sales and marketing personnel, client support personnel, professional services personnel, software engineers, technical personnel and management personnel, and the availability of such personnel may be constrained.

As we continue to grow, including from the integration of employees and businesses acquired in connection with previous or future acquisitions, we may find it difficult to maintain important aspects of our corporate culture, which could negatively affect our profitability and our ability to retain and recruit qualified personnel who are essential for our future success. If we do not effectively manage our growth, we may not be able to execute on our business plan, respond to competitive pressures, take advantage of market opportunities, satisfy client requirements or manufacture high-quality products. Additionally, we may not be able to expand and upgrade our infrastructure to accommodate future growth.

Failure to effectively manage our growth could also lead us to over-invest or under-invest in development and operations; result in weaknesses in our infrastructure, systems or controls; give rise to operational mistakes, financial losses, loss of productivity or business opportunities; and result in loss of employees and reduced productivity of remaining employees. Our growth is expected to require significant capital expenditures and may divert financial resources from other projects such as the development of new products and services. If we are unable to manage our growth effectively, our expenses may increase more than expected, our revenue may not increase or may grow more slowly than expected and we may be unable to implement our business strategy. Further, any failure to manage our growth effectively could materially and adversely affect our business, prospects, operating results and financial condition. We intend to expand our operations significantly which we expect our future expansion to include, among other things:

- expanding the management team;
- hiring and training new personnel;
- leveraging consultants to assist with company growth and development;
- conducting market research and analysis;
- controlling expenses and investments in anticipation of expanded operations;
- expanding design, production, and service departments;
- implementing and enhancing administrative infrastructure, systems and processes; and
- expanding our market share in international markets.

***Our operating and financial results forecast relies in large part upon assumptions and analyses developed by us. If these assumptions or analyses prove to be incorrect, our actual operating results may be materially different from our forecasted results.***

The projected financial and operating information appearing elsewhere in this proxy statement/prospectus/information statement reflect current estimates of future performance. Whether actual operating and financial results and business developments will be consistent with our expectations and assumptions as reflected in our forecasts depends on a number of factors, many of which are outside our control, including, but not limited to:

- success and timing of development activity;

- client acceptance of our products;
- competition, including from established and future competitors;
- whether we can obtain sufficient capital to sustain and grow our business;
- our ability to manage our growth;
- whether we can manage relationships with key clients and suppliers;
- our ability to retain existing key management, integrate recent hires and attract, retain and motivate qualified personnel; and
- the overall strength and stability of domestic and international economies.

Unfavorable changes in any of these or other factors, most of which are beyond our control, could materially and adversely affect our business, results of operations and financial results.

***If the estimates and assumptions we use to determine the size of our total addressable market are inaccurate, our future growth rate may be affected and our business would be harmed.***

Market estimates and growth forecasts are subject to significant uncertainty and are based on assumptions and estimates that may prove to be inaccurate. Even if the market in which we compete meets our size estimates and forecasted growth, our business could fail to grow at similar rates, if at all. Our market opportunity is also based on the assumption that our existing and future offerings will be more attractive to our clients than competing products. If these assumptions prove inaccurate, our business, financial condition, and results of operations could be adversely affected. For more information regarding our estimates of market opportunity and the forecasts of market growth included in this proxy statement/consent solicitation statement/prospectus, see “*Industry Overview Relating to noco-noco’s Business*” and “*noco-noco’s Business—Our Market Opportunities*.”

***We are subject to requirements relating to environmental and safety regulations and environmental remediation matters which could adversely affect our business, results of operation and reputation.***

Our operations are subject to environmental, health and safety rules laws and regulations laws and regulations including those governing hazardous material handling, transportation, and cleanup and occupational safety and health. There are significant capital, operating and other costs associated with compliance with these environmental laws and regulations. Environmental laws and regulations may become more stringent in the future, which could increase costs of compliance or require us to manufacture with alternative technologies and materials.

We have not yet commenced mass production for our battery products. When mass production is commenced, we will engage OEM suppliers for the manufacturing of our battery products. The manufacturing process will have hazards such as but not limited to hazardous materials, machines with moving parts, and high voltage and/or high current electrical systems typical of large manufacturing equipment and related safety incidents. There may be safety incidents that damage machinery or product, slow or stop production, or harm employees. Consequences may include litigation, regulation, fines, increased insurance premiums, mandates to temporarily halt production, workers’ compensation claims, or other actions that impact our company brand, finances, or ability to operate.

While we require that our OEMs and other suppliers have reasonably designed and implemented policies and programs to assure compliance with these laws and regulations and to avoid hazardous substance release liability, there can be no guarantee that the substantial costs incurred by new or more stringent compliance obligations will not be passed on to us.

***Regulatory actions, legal proceedings and customer complaints against us could harm our reputation and have a material adverse effect on our business, results of operations, financial condition and prospects. Our directors, management, shareholders and employees may also from time to time be subject to legal proceedings, which could adversely affect our reputation and results of operations.***

Along with growth and expansion of our business, we may be involved in litigation, regulatory proceedings and other disputes arising in or outside the ordinary course of our business. In general, such litigation and disputes may result in claims for actual damages, freezing of our assets, diversion of our management’s attention and reputational damage to us and our management, and the probability and amount of liability, if any, may remain unknown for long periods of time. Given the uncertainty, complexity and scope of many of these litigation matters, their outcome generally cannot be predicted with any reasonable degree of certainty. Therefore, our reserves for such matters may be inadequate. Moreover, even if we eventually prevail in these matters, we could incur significant legal fees or suffer significant reputational harm, which may negatively affect our operating results if changes to our business operations are required. There may also be negative publicity associated with litigation that could decrease consumer acceptance of our product offerings, regardless of whether the allegations are valid or whether we are ultimately found liable. In addition, our directors, management, shareholders and employees may from time to time be subject to litigation, regulatory investigations, proceedings and/or negative publicity or otherwise face potential liability and expense in relation to commercial, labor, employment, securities or other matters, which could adversely affect our reputation and results of operations. As a result, litigation may adversely affect our business, financial condition, results of operations or liquidity. See “*noco-noco’s Business—Legal Proceedings*” for more details.

***We may be subject to declining average selling and leasing prices, which may harm our revenue and gross profits.***

Electric vehicles, light electric vehicles and energy storage systems are subject to declines in average selling and leasing prices due to rapidly evolving technologies, industry standards and consumer preferences. As a result, our clients may expect us as suppliers to cut our costs and lower the price of our products in order to mitigate the negative impact on their own margins.

We expect to face possible market-driven downward pricing pressures in the future. Our revenue and profitability will suffer if we are unable to offset any declines in our average selling or leasing prices by developing new or enhanced products with higher prices or gross profit margins, increasing our sales or leasing volumes or reducing the material costs of our products on a timely basis.

***Our battery products rely on software and hardware that are highly technical, and if these systems contain errors, bugs or vulnerabilities, or if we are unsuccessful in addressing or mitigating technical limitations in our systems, our business could be adversely affected.***

Our products rely on software and hardware, including software and hardware developed or maintained internally or by third parties, that are highly technical and complex and will require modification and updates over the life of a battery product. Certain of our products depend on the ability of such software and hardware to store, retrieve, process and manage immense amounts of data. Our hardware and software or third party components and software that we utilize in our products may also contain defects in design or manufacture, including “bugs” and other problems that could unexpectedly interfere with the operation or security of the products. In addition, our systems are subject to certain technical limitations that may compromise our ability to meet the objectives. Some errors, bugs or vulnerabilities inherently may be difficult to detect and may only be discovered after the code has been released for external or internal use. Although we attempt to remedy any issues that we observe in our products as effectively and rapidly as possible, such efforts may not be timely, may hamper production, or may not be to the satisfaction of our clients. If we are unable to prevent or effectively remedy errors, bugs, vulnerabilities or defects in our software and hardware, we may suffer damage to our brand, loss of clients, loss of revenue or liability for damages, any of which could adversely affect our business and financial results.

***The unavailability, reduction or elimination of government and economic incentives due to policy changes or government regulation could have a material adverse effect on our business, prospects, financial condition and operating results.***

Any reduction, elimination or discriminatory application of government subsidies and economic incentives because of policy changes, the reduced need for such subsidies and incentives due to the perceived success of the electric vehicle industry or other reasons may result in the diminished competitiveness of the alternative fuel and electric vehicle industry generally or our battery power solutions. While certain tax credits and other incentives for alternative energy production, alternative fuel and electric vehicles have been available in the past, there is no guarantee these programs will be available in the future or that they will remain at current levels. In particular, our business will be affected by local and foreign tax credits, rebates, grants and other government programs and incentives that promote the use of electric vehicles. Additionally, our business will be affected by laws, rules and regulations that require reductions in carbon emissions or the use of renewable fuels. These programs and regulations, which have the effect of encouraging the demand for electric vehicles, could expire or be repealed or amended for a variety of reasons. For example, parties with an interest in gasoline and diesel, natural gas or other alternative vehicles or vehicle fuels, including lawmakers, regulators, policymakers, environmental or advocacy organizations, OEMs, trade groups, suppliers or other powerful groups, may invest significant time and money in efforts to delay, repeal or otherwise negatively influence regulations and programs that promote battery powered vehicles. Many of these parties have substantially greater resources and influence than we have. Further, changes in local or foreign political, social or economic conditions, including a lack of legislative focus on these programs and regulations, could result in their modification, delayed adoption or repeal. Any failure to adopt, delay in implementation, expiration, repeal or modification of these programs and regulations, or the adoption of any programs or regulations that encourage the use of other alternative fuels or alternative vehicles over battery power, would reduce the market for batteries as a source of power and harm our operating results, liquidity and financial condition.

***We will face risks associated with potential international operations, including unfavorable local regulatory, political, tax and labor conditions, which could harm our business.***

We will face risks associated with any potential international operations, including possible unfavorable local regulatory, political, tax and labor conditions, which could harm our business. We anticipate having subsidiaries that are subject to the legal, political, regulatory and social requirements and economic conditions in international jurisdictions. We may be subject to a number of risks associated with international business activities that may increase our costs, impact our ability to manufacture, sell or lease our products and require significant management attention. These risks include, but are not limited to:

- conforming our products to various international regulatory requirements where those products are sold or leased, which requirements may change over time;
- local and foreign government trade restrictions, tariffs and price or exchange controls;
- changes in diplomatic and trade relationships;
- political instability, civil disturbances, war, military conflict, religious or ethnic strife, terrorism and general security concerns;
- the occurrence of severe health epidemics, pandemics or other disease outbreaks; and
- the strength of international economies.

If we fail to address these risks successfully, our business and prospects could be negatively impacted.

***Our operations and investments are located in Asia-Pacific and we are therefore exposed to various risks inherent in operating and investing in the region.***

We will be focusing primarily on the Asia-Pacific market, including but not limited to Singapore, Thailand, the Philippines, Indonesia, India, Australia, and PNG, which means that other than assets located in and most of the income derived from our Singapore and Australia business, our assets and income are located in emerging market countries. Emerging market countries are typically subject to greater political, policy, legal, economic, taxation and other risks and uncertainties, including but not limited to the risk of expropriation, nationalization and commercial or governmental disputes, inflation, interest rate and currency fluctuations and greater difficulty in enforcing or collecting payment against contracts or in having certainty that all required governmental and regulatory approvals necessary to run our business are in place and will be renewed. Asian markets are inherently non-homogenous and require bespoke business models for each country in which we operate which adds complexity and reduces economies of scale.

Emerging market countries where we operate may have less sophisticated legal, taxation and regulatory systems and frameworks, including but not limited to unexpected changes in, or inconsistent application, interpretation or enforcement of, applicable laws and regulatory requirements. In particular, because legislation and other laws and regulations in emerging markets are often undeveloped, it is frequently difficult to interpret those laws and regulations with certainty. Regulatory authorities may adopt different interpretations to the PubCo or may revise laws, regulations or interpretations, potentially with retrospective effect, in ways that adversely affect our business, financial condition and/or results of operations. This gives rise to increased risks relating to labor practices, foreign ownership restrictions, tax regulation and enforcement, difficulty in enforcing contracts, changes to or uncertainty in the relevant legal and regulatory regimes and other issues in the markets where we operate or may in the future operate. Such risks could interrupt or adversely impact some or all of our business and may adversely affect our business, financial condition and results of operations.

Most of the countries we will be focusing on have experienced political and social instability at various times in the past, including but not limited to acts of political violence and civil unrest. These countries also have been subject to a number of terrorist attacks and other destabilizing events, which have led to economic and social volatility. There can be no assurance that similar destabilizing events will not occur in the future. Any such destabilizing events could interrupt and adversely affect our business, financial condition and results of operations.

Investors should also note that emerging markets are also subject to rapid change. An increase in the perceived risks associated with investing in emerging economies could reduce foreign investment in these countries, which may have a materially adverse impact on the battery markets in those places, or make it more difficult for us to obtain debt and equity financing, which could adversely affect our financial capacity to meet our business objectives and therefore adversely affect our business, financial condition and results of operations.

***Fluctuations in foreign currency exchange rates will affect our financial results, which we report in U.S. Dollars.***

We plan to operate in multiple jurisdictions, which exposes us to the effects of fluctuations in currency exchange rates. We may earn revenue in Singaporean Dollars, Australia Dollars, Thai Baht, Indonesian Rupiah, Indian Rupee, Philippine Peso and PNG Kina among other currencies. Our consolidated financial statements are presented in U.S. Dollars, which is the functional currency of noco-noco. Fluctuations in the exchange rates between the various currencies that we use could result in expenses being higher and revenue being lower than would be the case if exchange rates were stable. We cannot assure you that movements in foreign currency exchange rates will not have a material adverse effect on our results of operations in future periods. Furthermore, a substantial amount of our revenue is denominated in emerging markets currencies. Because fluctuations in the value of emerging markets currencies are not necessarily correlated, there can be no assurance that our results of operations will not be adversely affected by such volatility.

***Changes in public policies affecting the development and more widespread adoption of electric vehicles could affect the demand for our products.***

We mainly offer leasing services of our battery products, including batteries, BEVs and ESS, and manage carbon abatement projects and sell carbon credits to commercial transportation companies, renewable energy plants and power plants. If the market for electric vehicles or renewable energy does not develop, demand for our products or services could be harmed. As a result, our success depends, in part, on laws that affect demand for electric vehicles. For example, laws compelling the reduction of greenhouse gas emissions could create opportunity for increased sales of our batteries for incorporation in BEVs. Incentives, including tax credits or rebates, for electric vehicle purchases to reduce greenhouse gas emissions create a climate in which our sales may increase. Eliminating or phasing out such incentives could have the opposite effect. The continuous generation of carbon credits is an essential component to offset the unavoidable emissions in our leasing business. Our financial success may depend, in part, on our ability to generate tradable regulatory emission credits and provide carbon offset solutions to our clients. Laws that restrict or diminish the value of such credits may lessen our electric vehicle producing clients' demand for our batteries.

***Our carbon abatement solutions business may be impacted by climate-related activities.***

Our carbon abatement solutions business may be impacted by certain climate-related activities, including:

- technological advancements in the carbon reduction/removal process to mitigate climate change;
- domestic and international regulatory compliance response to climate change, or imposition of any specific taxation, penalties or fines, and
- unpredictable and extreme weather patterns and events which may extend to a long-term shift in climate weather patterns.

Given our carbon abatement solutions business are largely exposed to climate-related activities, any unfavorable changes will have an adverse impact on us, and may further impact the ongoing viability of our carbon abatement projects.

***Our business depends substantially on the continuing efforts of our senior management team and the loss of one or more of these employees could adversely affect our business.***

Our success depends largely upon the continued services of our key executive officers. We also rely on our management team in the areas of research and development, marketing, services and general administrative functions. If one or more of our other senior executives are unable or unwilling to continue to work for us in their present positions, we would be significantly disadvantaged. Moreover, if any of our current or former senior executives joins a competitor or forms a competing company, we may lose clients, suppliers, know-how and key personnel. Each of our executive officers has entered into an employment agreement with us, which contains confidentiality clauses.

Our success also depends, in part, on our continuing ability to identify, hire, attract, train and develop other highly qualified personnel, in particular engineers specializing in various disciplines, including battery design and production. Experienced and highly skilled employees are in high demand and competition for these employees can be intense. Our ability to hire, attract and retain them depends on our ability to provide competitive compensation packages. We may not be able to attract, integrate, train, motivate or retain additional highly qualified personnel, and our failure to do so could adversely affect our business, prospects, financial condition and operating results.

The unexpected loss of or failure to retain one or more of our key employees could adversely affect our business. We do not currently maintain key man life insurance policies with respect to every officer and following the completion of the Business Combination, the PubCo will evaluate whether to obtain such additional key man life insurance policies. Any failure by our management team and our employees to perform as expected may have a material adverse effect on our business, prospects, financial condition and operating results.

***Any failure to offer high-quality maintenance services may adversely affect our relationships with our clients and harm our financial results.***

We are highly dependent on the quality of our products, our business reputation and on strong recommendations from our existing clients. Any failure to maintain high-quality maintenance services, or a market perception that we do not maintain high-quality maintenance, could harm our reputation, adversely affect our ability to lease our products to existing and prospective clients, and harm our business, operating results and financial condition.

We provide maintenance services with the batteries, BEVs and ESS when we lease to our clients and may be unable to respond quickly enough to accommodate short-term increases in demand for maintenance services, particularly as we increase the size of our client base. Additionally, increased demand for these services, without corresponding revenue, could increase costs and adversely affect our results of operations.

***Our management has limited experience in operating a public company.***

Our executive officers have limited experience in the management of a publicly traded company. Our management team may not successfully or effectively manage our transition to a public company that will be subject to significant regulatory oversight and reporting obligations under federal securities laws. Their limited experience in dealing with the increasingly complex laws pertaining to public companies could be a significant disadvantage in that it is likely that an increasing amount of their time may be devoted to these activities which will result in less time being devoted to the management and growth of PubCo. We may not have adequate personnel with the appropriate level of knowledge, experience, and training in the accounting policies, practices or internal controls over financial reporting required of public companies in the United States. The development and implementation of the standards and controls necessary for PubCo to achieve the level of accounting standards required of a public company in the United States may require costs greater than expected. It is possible that PubCo will be required to expand its employee base and hire additional employees to support its operations as a public company which will increase its operating costs in future periods.

***We have identified material weaknesses in our internal control over financial reporting. Our failure to maintain an effective system of internal control over financial reporting may result in material misstatements of our consolidated financial statements or cause us to fail to meet our periodic reporting obligations, which may adversely affect investor confidence in PubCo and, as a result, the value of PubCo's shares.***

Our management has concluded that, as of June 30, 2022, our existing disclosure controls and procedures and internal control over financial reporting were ineffective, due to a material weakness. The material weakness relates to lack of sufficient financial reporting and accounting personnel, especially those with U.S. GAAP knowledge. See "Management's Discussion and Analysis of Financial Condition and Results of Operations of noco-noco—Internal Control Over Financial Reporting" for further details. Moreover, even if our management may in the future conclude that our internal control over financial reporting is effective, our independent registered public accounting firm, after conducting its own independent testing, may issue a report that is qualified if it concludes that we have not maintained, in all material respects, effective internal control over financial reporting based on criteria established in Internal Control - Integrated Framework (2013) issued by the Committee of Sponsoring Organizations of the Treadway Commission (COSO). During the course of documenting and testing our internal control procedures, in order to satisfy the requirements of Section 404 of the Sarbanes-Oxley Act of 2002, we may identify other weaknesses and deficiencies in our internal control over financial reporting. If we fail to maintain the adequacy of our internal control over financial reporting, we may not be able to conclude on an ongoing basis that we have effective internal control over financial reporting in accordance with Section 404 of the Sarbanes-Oxley Act of 2002. If we fail to achieve and maintain an effective internal control environment, we could suffer material misstatements in our financial statements and fail to meet our reporting obligations, which would likely cause investors to lose confidence in our reported financial information. This could in turn limit our access to capital markets, harm our results of operations, and lead to a decline in the trading price of our ordinary shares. Additionally, ineffective internal control over financial reporting could expose us to increased risk of fraud or misuse of corporate assets and subject us to potential delisting from the stock exchange on which we list, regulatory investigations and civil or criminal sanctions.

After we become a public company, our reporting obligations may place a significant strain on our management, operational and financial resources and systems for the foreseeable future. Section 404 of the Sarbanes-Oxley Act requires that PubCo include a report from management on the effectiveness of the PubCo's internal control over financial reporting in PubCo's annual report on Form 20-F beginning with its second annual report on Form 20-F after becoming a public company. In addition, once PubCo ceases to be an "emerging growth company" as such term is defined in the JOBS Act, PubCo's independent registered public accounting firm may need to attest to and report on the effectiveness of our internal control over financial reporting. We may be unable to timely complete our evaluation testing and any required remediation. In addition, because PubCo will be an "emerging growth company" and intends to take advantage of exemptions from various reporting requirements that are applicable to most other public companies, including, but not limited to, an exemption from the provisions of Section 404(b) of the Sarbanes-Oxley Act requiring that PubCo's independent registered public accounting firm provide an attestation report on the effectiveness of its internal control over financial reporting, any remedial measures that we take to remedy material weaknesses and control deficiencies may not be independently verified by an independent third party.

The growth and expansion of our business may place a significant strain on our operational and financial resources in the future. As we continue to grow, we may not be able to successfully implement requisite improvements to our internal control systems, controls and processes, such as system access and change management controls, in a timely or efficient manner. Our failure to improve our systems and processes, or their failure to operate in the intended manner, whether as a result of the growth of our business or otherwise, may result in our inability to accurately forecast our revenue and expenses, or to prevent certain losses. Moreover, the failure of our systems and processes could undermine our ability to provide accurate, timely and reliable reports on our financial and operating results and could impact the effectiveness of our internal control over financial reporting.

***We may need to raise additional funds and these funds may not be available to us when we need them. If we cannot raise additional funds when we need them, our business, prospects, financial condition and operating results could be negatively affected.***

The design, manufacture, sale and servicing of our battery products are capital-intensive. We expect that following the consummation of the Business Combination, we will have sufficient capital to fund our planned operations for the next three years, at which point we expect to be generating self-sustaining free cash flow. However, we may need to raise additional capital to scale our operations, continue licensing in intellectual properties and technologies and expand into emerging markets. Further, we may subsequently determine that additional funds are necessary earlier than anticipated. We may raise additional funds through the issuance of equity, equity related or debt securities, or through obtaining credit from government or financial institutions. This capital may be necessary to fund our ongoing operations, continue improving our technologies, and development and design efforts. We cannot be certain that additional funds will be available to us on favorable terms when required, or at all. If we cannot raise additional funds when we need them, our financial condition, results of operations, business and prospects could be materially adversely affected.



***We rely on information technology and any failure, inadequacy, interruption or security lapse of that technology, including any cybersecurity incidents, could harm our ability to operate our business effectively.***

Experienced computer programmers and hackers may be able to penetrate our network and misappropriate or compromise our confidential information or that of third parties, create system disruptions or cause shutdowns. Computer programmers and hackers also may be able to develop and deploy viruses, worms and other malicious software programs that attack our products or otherwise exploit any security vulnerabilities of our products. While we employ a number of protective measures, including firewalls, network infrastructure vulnerability scanning, anti-virus and endpoint detection and response technologies, these measures may fail to prevent or detect attacks on our systems which could adversely affect our business, operations, or products.

Any claim that our products or systems are subject to a cybersecurity risk, whether valid or not, could damage our reputation and adversely impact our revenues and results of operations. We manage and store various proprietary information and sensitive or confidential data relating to our business, which in the future may as well contain information from our suppliers and clients. Breaches of our or any of our third party suppliers' security measures or the accidental loss, inadvertent disclosure or unapproved dissemination of proprietary information or sensitive or confidential data about us or our clients or suppliers, including the potential loss or disclosure of such information or data as a result of fraud, trickery or other forms of deception, could expose us or our clients or suppliers to a risk of loss or misuse of this information, result in litigation and potential liability for us, damage our brand and reputation or otherwise harm our business.

To the extent we experience cyber-security incidents in the future, our relationships with our clients and suppliers may be materially impacted, our brand and reputation may be harmed and we could incur substantial costs in responding to and remediating the incidents and in resolving any investigations or disputes that may arise with respect to them, any of which would cause our business, operations, or products to be adversely affected. In addition, the cost and operational consequences of implementing and adding further data protection measures could be significant.

***We may in the future be, adversely affected by the global COVID-19 pandemic or other similar outbreaks.***

We face various risks related to epidemics, pandemics, and other outbreaks, including the recent COVID-19 pandemic. The impact of COVID-19, including changes in consumer and business behavior, pandemic fears and market downturns, and restrictions on business and individual activities, has created significant volatility in the global economy and led to reduced economic activity. The spread of COVID-19 may impact our potential clients and suppliers by disrupting the manufacturing, delivery and overall supply chain of battery and BEV manufacturers and suppliers and may lead to a global decrease in battery and BEV sales or leasing in markets around the world.

The pandemic has resulted in government authorities implementing numerous measures to try to contain the virus, such as travel bans and restrictions, quarantines, stay-at-home or shelter-in-place orders, and business shutdowns. Although we had not experienced any impact from the pandemic, these measures still may adversely impact our employees, research and development activities and operations and the operations of our suppliers, vendors and business partners, and may negatively impact our sales and marketing activities in the future. In addition, various aspects of our business cannot be conducted remotely. These measures by government authorities may remain in place for a significant period of time and they are likely to continue to adversely affect our future manufacturing plans, sales and marketing activities, business and results of operations. We may take actions as may be required by government authorities or that it determines are in the best interests of its employees, suppliers, vendors and business partners.

The extent to which the COVID-19 pandemic may impact our business, prospects and results of operations will depend on future developments, which are highly uncertain and cannot be predicted, including the duration and spread of the pandemic, its severity, the actions to contain the virus or treat its impact, and how quickly and to what extent normal economic and operating activities can resume. Even after the COVID-19 pandemic has subsided, we may experience an adverse impact to its business as a result of its global economic impact, including any recession that has occurred or may occur in the future.

There are no comparable recent events that may provide guidance as to the effect of the spread of COVID-19 and a pandemic, and, as a result, the ultimate impact of the COVID-19 pandemic or a similar health epidemic is highly uncertain.

The future impact of the COVID-19 outbreak is highly uncertain and cannot be predicted and there is no assurance that such outbreak will not have a material adverse impact on our business, financial condition and results of operations. The extent of the impact will depend on future developments, including actions taken to contain COVID-19, and if these impacts persist or exacerbate over an extended period of time.

***We may not achieve the intended tax efficiencies of our corporate structure and intercompany arrangements, which could increase our worldwide effective tax rate.***

Our corporate structure and intercompany arrangements, including but not limited to the manner in which we conduct our intercompany and related party transactions, are intended to provide us with worldwide tax efficiencies. The application of tax laws of various jurisdictions to our business activities is subject to interpretation and also depends on our ability to operate our business in a manner consistent with our corporate structure and intercompany arrangements. The tax authorities of jurisdictions where we operate may challenge our methodologies for intercompany and related party arrangements, including but not limited to transfer pricing, or determine that the manner in which we operate does not achieve the intended tax consequences, which could increase our worldwide effective tax rate and adversely affect our business, financial position and results of operations.

A certain degree of judgment is required in evaluating our tax positions and determining our provision for income taxes. In the ordinary course of business, there are many transactions and calculations for which the ultimate tax determination is uncertain. For example, our effective tax rate could be adversely affected by lower than anticipated earnings in markets where we have lower statutory rates and higher than anticipated earnings in markets where we have higher statutory rates, by changes in foreign currency exchange rates or by changes in the relevant tax, accounting and other laws, regulations, principles and interpretations. Any of these factors could adversely affect our business, financial position and results of operations.

***We could face uncertain tax liabilities in various jurisdictions in which we operate, which could adversely impact our operating results.***

We are subject to the tax laws and policies of each of the countries in which we operate. Since legislation and other laws and regulations (particularly in relation to tax) in emerging markets, such as the markets where we operate, are often undeveloped and the interpretation, application and enforcement of tax laws and policies in emerging market countries is uncertain, there is a risk that we may be unable to determine our taxation obligations with certainty.

We obtain external tax advice from time to time on the application of tax laws to our operations. Due to the aforementioned challenges of interpretation and consistency of application and enforcement, obtaining such advice may be difficult and opinions on the law may differ. The determination of our provision for tax liabilities requires significant judgment and estimation and there are classifications, transactions and calculations where the ultimate tax payable is uncertain.

Our tax exposure and obligations exist in each of the jurisdictions in which we presently operate and may arise in other jurisdictions in the future in the event that we commence operations in such new jurisdictions, either organically or through acquisitions. These risks may increase when we acquire a business, particularly to the extent that there are limitations or restrictions on the scope or nature of the financial, tax and other due diligence investigations that we are able to undertake in connection with the acquisition, or where the vendors withhold material information. Given the nature of our business, we are also exposed to the general changes in digital taxation policy that are happening globally.

From time to time, we establish provisions to account for uncertainties as well as timing and accounting differences in respect of income tax and indirect taxes, including but not limited to in relation to businesses that are acquired by us. While we have established our tax and other provisions using assumptions and estimates that we believe to be reasonable, these provisions may prove insufficient given the risks and uncertainties inherent in the taxation systems in the countries where we operate. Any adverse determinations by a revenue authority in relation to our tax obligations may have an adverse effect on our business, financial condition and results of operations, and may adversely impact our operations in the relevant jurisdiction and our reputation.

***Our business activities in the Oceanian countries may be subject to native title and/or indigenous cultural heritage rights.***

Native title and/or indigenous cultural heritage rights may impact our ability to obtain landowner agreements, permits and approvals. In Australia, the Native Title Act 1993 (Cth) recognizes rights of indigenous Australians over land, and such recognition may impact or delay our ability to carry out our business activities, either wholly or partially. There are also Australian state and territory legislations which impose duties of care on us to ensure all practical and reasonable measures are taken to avoid damaging or destroying indigenous cultural heritage. These laws and regulations are subject to constant review and amendments. If we are unable to obtain consent from indigenous persons to the potential target areas of a planned carbon abatement project, that particular project would have to be abandoned, which will adversely affect our business and financial performance.

In addition, our business activities may be subject to the First Nations and/or indigenous persons claims. To carry out our business activities, consultation and discussions with the First Nations and/or other indigenous groups will be required from time to time. Any unsuccessful consultation or discussions will impact our ability to perform our business activities. In the event the land underlying a carbon abatement project is determined to be native title, we will need to appropriately amend our internal policies and procedures to ensure compliance, which may delay our project timeline and adversely affect our business. In addition, we may at times be restricted, either legally or culturally, from the properties or lands due to sociological issues, which may also adversely affect our business.

***We may be subject to government policy changes under the federal political system of Australia.***

Australia has consistently operated under a mild two-party federal political system, with two major party alliances dominating the political groupings in the Australian system. The carbon abatement projects, although having experienced prolonged periods of continuance between both party alliances, may be revoked upon a change in the federal system to be realigned with the incumbent political party's policies. Any change in government policies, legislation or regulation that affect carbon abatement projects may directly impact our business operations. Generally, the state-based political parties in Australia also follow a mild two-party system, which may present conflicts between state policies and federal policies, in turn creating uncertainty and volatility for our operations.

In addition, there may be changes in taxation, interest rates and other administrative functions of both the state and federal governing laws and regulations which may have an adverse impact on our assets, operations and financial performance. Changes to existing laws and regulations governing the carbon abatement projects may also require us to implement such changes, which may adversely impact both current and any future projects. See “—Risks Related to noco-noco's Business and Industry—Uncertainties with respect to laws and regulations in the countries in which we operate could adversely affect our business, financial condition and results of operations.”

***Uncertainties with respect to laws and regulations in the countries in which we operate could adversely affect our business, financial condition and results of operations.***

Our business is subject to a range of regulations, including but not limited to safety, environmental, tax, anti-money laundering, countering of terrorism financing and competition legislation in different jurisdictions. Governments and regulatory authorities in the countries where we operate may from time to time make changes to applicable laws and regulatory policies, which may make it more difficult or onerous for us to operate. Additionally, laws and policies in emerging markets may change at short notice and may subject us to additional penalties. See “—Risks Related to noco-noco's Business and Industry—Our operations and investments are located in Asia-Pacific and we are therefore exposed to various risks inherent in operating and investing in the region.”

In addition, any interpretation of laws and practice by the governments and/or regulatory authorities that is contrary to our views of those laws and practice may adversely affect our liabilities or expose us to legal, regulatory or other actions. Inconsistent enforcement of laws also creates compliance risks, as it may make it difficult for us to engage with regulatory authorities on compliance matters. Such inconsistency may also result in variability in the penalties associated with any non-compliance. Appeals against the enforcement actions taken by regulatory authorities may not always be possible, and it may take a long time to reach conclusion, may incur significant costs and the results may be uncertain and involve external influences outside our control.

### **Risks Related to PNAC and the Business Combination**

*Unless the context otherwise requires, all references in this subsection to the “Company,” “PNAC”, “we,” “us” or “our” refer to the business of PNAC and its subsidiaries prior to the consummation of the Business Combination.*

#### ***PNAC will incur significant transaction and transition costs in connection with the Business Combination.***

PNAC has incurred and expects to incur significant, non-recurring costs in connection with consummating the Business Combination. Certain transaction expenses incurred in connection with the Business Combination, including all legal, accounting, consulting, investment banking and other fees, expenses, and costs, will be paid by PubCo at or following the closing of the Business Combination.

#### ***PNAC will have limited rights after the Closing to make claims for damages against noco-noco or noco-noco’s stockholders for the breach of representations, warranties, or covenants made by noco-noco in the Business Combination Agreement.***

The Business Combination Agreement provides that, except in the case of fraud, all of the representations, warranties and covenants, obligations or other agreements of the parties contained therein shall not survive the Closing, except for a limited number of covenants, obligations or other agreements of the parties that by their terms apply or are to be performed in whole or in part after the Closing, and then only with respect to breaches occurring after Closing. Accordingly, except in the case of fraud, PNAC will have no rights to make damage claims against noco-noco after the Closing with respect to any breach of the representations and warranties, and will have limited rights to make damage claims against noco-noco after the Closing with respect to covenants, or agreements contained in the Business Combination Agreement that survive and the covenants to be performed in whole or in part after the Closing.

#### ***After the Closing, PubCo may be required to take write-downs or write-offs, restructuring and impairment or other charges that could have a significant negative effect on its financial condition, results of operations and the price of shares of PubCo Ordinary Shares, which could cause you to lose some or all of your investment.***

Although PNAC has conducted due diligence on noco-noco, PNAC cannot assure you that this diligence revealed all material issues that may be present in noco-noco’s business, that it would be possible to uncover all material issues through a customary amount of due diligence, or that factors outside of PNAC’s and noco-noco’s control will not later arise. As a result, after the Closing, PubCo may be forced to later write-down or write-off assets, restructure its operations, or incur impairment or other charges that could result in losses. Even if PNAC’s due diligence successfully identifies certain risks, unexpected risks may arise and previously known risks may materialize in a manner not consistent with PNAC’s preliminary risk analysis. Even though these charges may be non-cash items and may not have an immediate impact on PubCo’s liquidity, the fact that PubCo may incur charges of this nature could contribute to negative market perceptions about PubCo’s securities. In addition, charges of this nature may cause PubCo to be unable to obtain future financing on favorable terms or at all. Accordingly, any PNAC stockholder who chooses to remain a stockholder of PubCo following the Business Combination could suffer a reduction in the value of their shares of PubCo Ordinary Shares. Such stockholders are unlikely to have a remedy for such reduction in value unless they are able to successfully claim that the reduction was due to the breach by PNAC’s officers or directors of a duty of care or other fiduciary duty owed to them, or if they are able to successfully bring a private claim under securities laws that the proxy solicitation relating to the Business Combination contained an actionable material misstatement or material omission.

***The PNAC Initial Stockholders own PNAC Common Stock that will be worthless, may be unable to be repaid in full for the working capital loans provided to PNAC, and may incur reimbursable expenses that may not be reimbursed or repaid if the Business Combination is not approved. Such interests may have influenced their decision to approve and, in the case of the Board, recommend, the Business Combination with noco-noco.***

The PNAC Initial Stockholders and/or their affiliates beneficially own or have a pecuniary interest in the PNAC Founder Shares and PNAC Private Shares. As of the Record Date, the PNAC Initial Shareholders owned and were entitled to vote 2,011,392 shares of PNAC Common Stock, representing approximately 29.05% of the issued and outstanding shares of PNAC Common Stock. The holders have no redemption rights with respect to these securities in the event a business combination is not effected in the required time period. Therefore, if the Business Combination with noco-noco or another business combination is not approved within the required time period, such securities held by such persons will be worthless. Based upon the closing price of PNAC Common Stock of [\$ ] per share on Nasdaq on the Record Date, such securities had an implied aggregate market value, assuming the Business Combination is consummated, of approximately [\$ ] million. Accordingly, the PNAC Initial Shareholders may be incentivized to complete the Business Combination, or an alternative business combination, with a less favorable target company or on terms less favorable to stockholders than they would otherwise recommend or approve, as the case may be, rather than allow PNAC to wind up having failed to consummate a business combination and lose their entire investment.

Additionally, in order to finance transaction costs in connection with an intended initial business combination, the Sponsors, directors, officers or affiliates of PNAC may, but are not obligated to, loan PNAC funds as may be required. If PNAC completes the Business Combination, PNAC would repay such loaned amounts out of the proceeds of the Trust Account released to PNAC. Otherwise, such loans would be repaid only out of funds held outside the Trust Account. In the event that the Business Combination does not close, PNAC may use a portion of the working capital held outside the Trust Account to repay such loaned amounts but no proceeds from the Trust Account would be used to repay such loaned amounts. Up to \$3,000,000 of such loans may be convertible into the Working Capital Shares, at a price of \$10.00 per share at the option of the lender. As of March 31, 2023, PNAC had no borrowings under the Working Capital Loans.

Furthermore, the PNAC Initial Stockholders are entitled to reimbursement of out-of-pocket expenses incurred by them related to identifying, investigating, and consummating an initial business combination. Any such expenses will be repaid upon completion of the Business Combination with noco-noco. [As of the date of this proxy statement/prospectus, no such reimbursable expenses have been incurred.] If any such expenses are incurred, however, if PNAC fails to consummate the Business Combination, they will not have any claim against the Trust Account for repayment or reimbursement. Accordingly, PNAC may not be able to repay or reimburse these amounts if the Business Combination is not completed. See the section entitled “*The Business Combination Proposal—Interests of PNAC’s Directors and Officers in the Business Combination.*”

These financial interests may have influenced the decision of PNAC’s directors to approve the Business Combination with noco-noco and to continue to pursue such Business Combination. In considering the recommendations of PNAC Board to vote for the Business Combination Proposal and other Proposals, PNAC Public Stockholders should consider these interests.

***The PNAC Public Stockholders will experience immediate dilution as a consequence of the issuance of PubCo Ordinary Shares immediately following consummation of the Business Combination and Transaction Financing and in connection with the Business Combination.***

PNAC Public Stockholders who do not redeem their PNAC Public Shares will experience immediate dilution as a consequence of the issuance of PubCo Ordinary Shares immediately following consummation of the Business Combination and Transaction Financing and may experience dilution from several additional sources to varying degrees in connection with and after the Business Combination, including the following:

- In accordance with the terms and subject to the conditions of the Business Combination Agreement, upon consummation of the Share Exchange, each Seller shall receive such fraction of a newly issued PubCo Ordinary Share that is equal to the quotient of \$1,350,000,000 (the “noco-noco Valuation”), divided by the product of (a) the price per PubCo Ordinary Share that equals to the redemption price of each share of PNAC Class A Common Stock in connection with the Business Combination and (b) such Seller’s Pro Rata Portion as set out in the Allocation Schedule of the Business Combination Agreement

- In addition, in connection with the Transaction Financing, PubCo Ordinary Shares of at least \$20,000,000 will be issued.
- [Up to [\_\_\_\_\_]] shares of PubCo Ordinary Shares issuable upon exercise of the PubCo Warrants (Upon the consummation of the Business Combination, pursuant to the Warrant Assumption Agreement, each PNAC Warrant outstanding immediately prior to the Merger Effective Time shall cease to be a warrant with respect to PNAC Common Stock, and shall be assumed by PubCo and converted into a warrant of PubCo to purchase one PubCo Ordinary Share, subject to substantially the same terms and conditions prior to the consummation of the Business Combination), which will become exercisable 30 days after the completion of the Business Combination. The shares of PubCo Ordinary Shares underlying these PubCo Warrants, represent approximately [\_\_%] or [\_\_%] of the fully-diluted number of shares of PubCo Ordinary Shares immediately following the consummation of the Business Combination, assuming the no redemption scenario and the maximum redemption scenario, respectively. See “— *PubCo Warrants will become exercisable for PubCo Ordinary Shares 30 days after the completion of the Business Combination, which would increase the number of shares eligible for future resale in the public market and result in dilution to PNAC stockholders. Such dilution will increase if more of the PNAC Public Shares are redeemed.*” Once PubCo Warrants become exercisable, PubCo will have no opportunity to manage the dilution therefrom, except that PubCo has the ability to redeem outstanding PNAC Warrants at any time after they become exercisable and prior to their expiration, at a price of \$0.01 per PubCo Warrants, provided that the last reported sales price of PubCo Ordinary Share equals or exceeds \$16.50 per share (as adjusted for stock splits, stock dividends, reorganizations, recapitalizations and the like) for any 20 trading days within a 30 trading-day period ending on the third business day prior to the date on which PubCo gives proper notice of such redemption and provided certain other conditions are met.
- PubCo will reserve 5% of the outstanding PubCo Ordinary Shares as of the Closing under the PubCo Incentive Plan, which represent approximately 4.8% of the fully-diluted number of shares of PubCo Ordinary Shares immediately following the consummation of the Business Combination, assuming the no redemption scenario and the maximum redemption scenario, respectively.
- Up to 300,000 Working Capital Shares to the Sponsors or their affiliates or designees, assuming the holders of working capital promissory notes select to convert the working capital promissory notes into Working Capital Shares.

The issuance of additional PubCo Ordinary Shares as discussed above will significantly dilute the equity interests of existing holders of PNAC securities, diminish the relative voting strength of existing holders of PNAC securities, and may adversely affect prevailing market prices for the PubCo Ordinary Shares.

***The exercise of PNAC’s directors’ and officers’ discretion in agreeing to changes or waivers in the terms of the Business Combination Agreement may result in a conflict of interest when determining whether such changes to the terms of the Business Combination Agreement or waivers of conditions are appropriate and in the best interests of PNAC Public Stockholders.***

In the period leading up to the Closing, events may occur that, pursuant to the Business Combination Agreement, would require PNAC to agree to amend the Business Combination Agreement, to consent to certain actions taken by noco-noco or to waive rights that PNAC is entitled to under the Business Combination Agreement. Such events could arise because of changes in the course of noco-noco’s business, a request by noco-noco to undertake actions that would otherwise be prohibited by the terms of the Business Combination Agreement or the occurrence of other events that would have a material adverse effect on noco-noco’s business and would entitle PNAC to terminate the Business Combination Agreement. In any of such circumstances, it would be at PNAC’s discretion, acting through PNAC Board, to grant its consent or waive those rights. The existence of the financial and personal interests of the directors described in the preceding risk factors may result in a conflict of interest on the part of one or more of the directors between what he, she or they may believe is best for PNAC and what he, she or they may believe is best for himself, herself, or themselves in determining whether or not to take the requested action. As of the date of this proxy statement/prospectus, PNAC does not believe there will be any material changes or waivers that PNAC’s directors and officers would be likely to make after the mailing of this proxy statement/prospectus. PNAC will circulate a supplemental or amended proxy statement/prospectus if changes to the terms of the Business Combination that would have a material impact on its stockholders are required prior to the vote on the Business Combination Proposal.

***If PNAC is unable to complete the Business Combination with noco-noco or another business combination by July 17, 2023 (or such later date if PNAC extend the period of time to consummate a business combination), PNAC Public Stockholders may receive only approximately \$10.34 per public share, or less than such amount in certain circumstances based on the balance of the Trust Account (as of December 31, 2022), and PNAC Warrants and PNAC Rights will expire worthless.***

Pursuant to the Business Combination Agreement, there are various closing conditions to be satisfied in order to complete the Business Combination, some of which are beyond PNAC's control. Currently, PNAC has until July 17, 2023 (or November 17, 2023, if fully extended) to consummate a business combination. If PNAC is unable to complete the Business Combination or any other alternative business combination, to the extent that the Business Combination Agreement is terminated for any reason, within the required period under the Existing PNAC Charter, Public Stockholders may only receive approximately \$10.34 per Public Share on the liquidation of the Trust Account, based on the balance of the Trust Account (as of December 31, 2022), and PNAC Warrants and PNAC Rights will expire worthless.

***If PNAC is unable to complete the Business Combination with noco-noco or another business combination by July 17, 2023 (or such later date if PNAC extend the period of time to consummate a business combination), PNAC will cease all operations except for the purpose of winding up, redeeming 100% of the outstanding PNAC Public Shares for cash and, subject to the approval of its remaining stockholders and its Board, dissolving and liquidating. In such event, third parties may bring claims against PNAC and, as a result, the proceeds held in the Trust Account could be reduced and the per-share liquidation price received by PNAC Public Stockholders could be less than \$10.25 per Public Share, and the PNAC Warrants and PNAC Rights will expire worthless.***

Under the terms of the Existing PNAC Charter, PNAC must complete the Business Combination with noco-noco or another business combination by July 17, 2023 (or such later date stockholders if PNAC extend the period of time to consummate a business combination, or as may be approved by PNAC stockholders in an amendment to the Existing PNAC Charter), or PNAC must (i) cease all operations except for the purpose of winding up, (ii) as promptly as reasonably possible but not more than 10 business days thereafter, redeem the PNAC Public Shares, at a per-share price, payable in cash, equal to the aggregate amount then on deposit in the Trust Account including interest earned on the funds held in the Trust Account and not previously released to PNAC to pay our taxes (less up to \$50,000 of interest to pay dissolution expenses), divided by the number of then outstanding PNAC Public Shares, which redemption will completely extinguish Public Stockholders' rights as stockholders (including the right to receive further liquidating distributions, if any), subject to applicable law, and (iii) as promptly as reasonably possible following such redemption, subject to the approval of PNAC's remaining stockholders and the PNAC Board, dissolve and liquidate, subject in each case to PNAC's obligations under Delaware law to provide for claims of creditors and the requirements of other applicable law. In such event, third parties may bring claims against PNAC. Although PNAC seeks waiver agreements from certain vendors and service providers it has engaged and owes money to, and the prospective target businesses it has negotiated with, whereby such parties will waive any right, title, interest or claim of any kind they may have in or to any monies held in the Trust Account, there is no guarantee that vendors, regardless of whether they execute such waivers, will not seek recourse against the Trust Account notwithstanding such agreements. Furthermore, there is no guarantee that a court will uphold the validity of such agreements. Accordingly, the proceeds held in the Trust Account could be subject to claims which could take priority over those of the PNAC Public Stockholders. If PNAC is unable to complete a business combination within the required time period, the Sponsor has agreed that it will be liable to us if and to the extent any claims by a third party for services rendered or products sold to PNAC, or a prospective target business with which PNAC has discussed entering into a Business Combination Agreement, reduce the amount of funds in the Trust Account to below (i) \$10.20 per PNAC Public Share or (ii) such lesser amount per Public Share held in the Trust Account as of the date of the liquidation of the Trust Account, due to reductions in value of the trust assets, in each case net of the amount of interest which may be withdrawn to pay taxes, except as to any claims by a third party who executed a waiver of any and all rights to seek access to the Trust Account and except as to any claims under the indemnity of the underwriters of the PNAC IPO against certain liabilities, including liabilities under the Securities Act. In the event that an executed waiver is deemed to be unenforceable against a third party, then the Sponsors will not be responsible to the extent of any liability for such third party claims. We have not independently verified whether the Sponsors have sufficient funds to satisfy its indemnity obligations and believe that the Sponsors' only assets are securities of PNAC. Additionally, we have not asked the Sponsors to reserve for such indemnification obligations. Therefore, we cannot assure you that the Sponsors would be able to satisfy such indemnification obligations. As a result, if any such claims were successfully made against the Trust Account, the funds available for the Business Combination and redemptions could be reduced to less than \$10.20 per PNAC Public Share. In such event, we may not be able to complete the Business Combination, and you would receive such lesser amount per share in connection with any redemption of your PNAC Public Shares. None of our officers will indemnify us for claims by third parties including, without limitation, claims by vendors and prospective target businesses.

Additionally, if PNAC is forced to file a bankruptcy case or an involuntary bankruptcy case is filed against it which is not dismissed, or if PNAC otherwise enters compulsory or court supervised liquidation, the proceeds held in the Trust Account could be subject to applicable bankruptcy law, and may be included in its bankruptcy estate and subject to the claims of third parties with priority over the claims of PNAC Public Stockholders. To the extent any bankruptcy claims deplete the Trust Account, PNAC may not be able to return to its Public Stockholders at least \$10.20 per share of PNAC Class A Common Stock. There will be no redemption rights or liquidating distributions with respect to the PNAC Warrants and PNAC Rights, which will expire worthless if PNAC fails to complete an initial business combination within the required period.

***If Transaction Financing or other equity financing is not available prior to or upon the closing of the Business Combination to satisfy certain conditions to Closing, the Business Combination may not be consummated.***

As of the date of this proxy statement/prospectus, neither PNAC nor noco-noco has obtained any firm commitment of financing for PubCo prior to or upon the closing of the Business Combination. Subject to PNAC's available cash after the shareholder redemption, the lack of committed Transaction Financing prior to or upon the closing of the Business Combination could potentially result in breach of certain conditions to the Share Exchange Closing as stipulated in the Business Combination Agreement and could, if not waived by the relevant parties, prohibit the closing of the Business Combination. For example, the net tangible assets of PubCo upon the closing of the Business Combination should be no less than \$5,000,001. In addition, PNAC's Available Acquiror Cash (as defined in the Business Combination Agreement) should be at least \$20,000,000 immediately prior to or upon the Share Exchange Closing. For more information about the closing conditions to the Business Combination, see "The Business Combination Proposal—The Business Combination Agreement—Conditions to Closing." Neither noco-noco nor PNAC can give any assurance that they will be able to obtain committed Transaction Financing on acceptable terms. Any Transaction Financing may significantly dilute the equity interest of the continuing shareholders of the PubCo and may include unfavorable terms, including giving the investor(s) of such Transaction Financing the ability to acquire shares at a price which is less than the market price of the PubCo Ordinary Shares at the time of purchase. noco-noco and PNAC can give no assurance that any of them will be able to enter into any financing arrangement or agreement on terms that it considers reasonable or which could reasonably be expected to reduce redemption of public shares by PNAC Public Stockholders.

***PNAC Public Stockholders may be held liable for claims by third parties against PNAC to the extent of distributions received by them.***

If PNAC is unable to complete the Business Combination with noco-noco or another business combination within the required time period, PNAC will (i) cease all operations except for the purpose of winding up, (ii) as promptly as reasonably possible but not more than ten business days thereafter, redeem the PNAC Public Shares, at a per-share price, payable in cash, equal to the aggregate amount then on deposit in the Trust Account including interest earned on the funds held in the Trust Account and not previously released to PNAC to pay our taxes (less up to \$50,000 of interest to pay dissolution expenses), divided by the number of then outstanding PNAC Public Shares, which redemption will completely extinguish PNAC Public Stockholders' rights as stockholders (including the right to receive further liquidating distributions, if any), subject to applicable law, and (iii) as promptly as reasonably possible following such redemption, subject to the approval of PNAC's remaining stockholders and PNAC Board, dissolve and liquidate, subject in each case to PNAC's obligations under Delaware law to provide for claims of creditors and the requirements of other applicable law. PNAC cannot assure you that it will properly assess all claims that may potentially be brought against PNAC. As such, PNAC Public Stockholders could potentially be liable for any claims to the extent of distributions received by them (but no more) and any liability of its stockholders may extend well beyond the third anniversary of the date of distribution. Accordingly, PNAC cannot assure you that third parties will not seek to recover from its stockholders amounts owed to them by PNAC.

If PNAC files a bankruptcy petition or an involuntary bankruptcy petition is filed against PNAC that is not dismissed, the proceeds held in the Trust Account could be subject to applicable bankruptcy law, and may be included in PNAC's bankruptcy estate and subject to the claims of third parties with priority over the claims of PNAC Public Stockholders. To the extent any bankruptcy claims deplete the Trust Account, PNAC cannot provide any assurance that PNAC will be able to return \$10.34 per share to our Public Stockholders. Additionally, if PNAC files a bankruptcy petition or an involuntary bankruptcy petition is filed against PNAC that is not dismissed, any distributions received by PNAC Public Stockholders could be viewed under applicable debtor/creditor and/or bankruptcy laws as either a "preferential transfer" or a "fraudulent conveyance." As a result, a bankruptcy court could seek to recover some or all amounts received by PNAC Public Stockholders. Furthermore, the PNAC Board may be viewed as having breached its fiduciary duty to PNAC's creditors and/or may have acted in bad faith, thereby exposing itself and PNAC to claims of punitive damages, by paying PNAC Public Stockholders from the Trust Account prior to addressing the claims of creditors. PNAC cannot provide any assurance that claims will not be brought against PNAC for these reasons.



***Activities taken by existing PNAC stockholders to increase the likelihood of approval of the Business Combination Proposal and the other Proposals could have a depressive effect on PNAC Common Stock.***

At any time prior to the Special Meeting, during a period when they are not then aware of any material nonpublic information regarding PNAC or its securities, the PNAC stockholders, noco-noco, or noco-noco's stockholders and/or their respective affiliates may enter into transactions with such investors and others to provide them with incentives to acquire PNAC Common Stock or vote their shares in favor of the Business Combination Proposal. The purpose of such transactions would be to increase the likelihood of satisfaction of the requirements to consummate the Business Combination where it appears that such requirements would otherwise not be met. Entering into any such arrangements may have a depressive effect on PNAC Common Stock. For example, as a result of these arrangements, an investor or holder may have the ability to effectively purchase shares at a price lower than market and may therefore be more likely to sell the shares he, she or it owns, either prior to or immediately after the Special Meeting.

If the Adjournment Proposal is not approved, and an insufficient number of votes have been obtained to authorize the consummation of the Business Combination, the PNAC Board will not have the ability to adjourn the Special Meeting to a later date in order to solicit further votes, and, therefore, the Business Combination will not be approved.

***The PNAC Board has not obtained, nor will it obtain, a fairness opinion prior to the Closing.***

In analyzing the Business Combination, the PNAC Board conducted significant due diligence on noco-noco. It believes because of the financial skills and background of its directors and officers, it was qualified to conclude that the Business Combination was fair from a financial perspective to the PNAC stockholders and that noco-noco's fair market value was at least 80% of the value of the funds in the Trust Account. Notwithstanding the foregoing, the PNAC Board did not obtain a fairness opinion to assist it in its determination. Accordingly, it may be incorrect in its assessment of the Business Combination.

***We are dependent upon our current executive officers and directors and their loss could adversely affect our ability to operate.***

Our operations are dependent upon a relatively small group of individuals and, in particular, our executive officers and directors. We believe that our success depends on the continued service of our officers and directors, at least until we have completed the Business Combination.

***The PNAC Initial Stockholders have agreed to vote in favor of the Business Combination, regardless of how PNAC Public Stockholders vote.***

The PNAC Initial Stockholders have agreed to vote the PNAC Founder Shares and PNAC Private Shares, as well as any PNAC Public Shares purchased during or after the PNAC IPO, in favor of the Business Combination.

As of the Record Date, the PNAC Initial Stockholders owned and were entitled to vote 2,011,392 shares of PNAC Common Stock (including 1612,500 PNAC Founder Shares and 398,892 PNAC Private Shares), representing approximately 29.53% of the voting power of the shares of PNAC Common Stock outstanding. As a result, in addition to the PNAC Founder Shares and PNAC Private Shares, we would need (i) assuming all outstanding shares voted, 1,450,454 shares (or 29.53% of the 4,912,299 PNAC Public Shares) to vote in favor, or (ii) assuming only the quorum is present and voted, no additional shares to vote in favor, in order to have the Business Combination Proposal approved. Accordingly, it is more likely that the necessary stockholder approval will be received than would be the case if such persons agreed to vote their shares in accordance with the majority of the votes cast by PNAC Public Stockholders.

***The PNAC Initial Stockholders and PNAC's directors and officers may have interests in the Business Combination different from the interests of PNAC Public Stockholders.***

The PNAC Initial Stockholders have financial interests in the Business Combination that are different from, or in addition to, those of other PNAC stockholders generally. Specifically: (i) the PNAC Initial Stockholders paid an aggregate of \$25,000 for 1,612,500 PNAC Founder Shares, among which Sponsor A holds 1,383,700 PNAC Founder Shares, Sponsor B holds 90,300 PNAC Founder Shares, and PNAC's officers, directors, secretary, and a member of Sponsor A collectively holds 138,500 PNAC Founder Shares, which will have a significantly higher value at the time of the Business Combination; and (ii) the Sponsors paid an aggregate of \$3,988,920 for 398,892 PNAC Private Shares, or \$10.00 per share, among which the Sponsor A holds 349,032 PNAC Private Shares, and Sponsor B holds 49,860 PNAC Private Shares. If PNAC does not consummate an initial business combination by the Final Redemption Date, then the proceeds from the sale of the PNAC Private Shares will be part of the liquidating distribution to the PNAC Public Stockholders and the PNAC Private Shares held by the PNAC Initial Stockholders will be worthless. As a result, the PNAC Initial Stockholders may be incentivized to complete the Business Combination, or an alternative initial business combination with a less favorable company or on terms less favorable to PNAC stockholders, rather than to liquidate, in which case the PNAC stockholders would lose their entire investment. As a result, the PNAC Initial Stockholders may have a conflict of interest in determining whether noco-noco is an appropriate business with which to effectuate a business combination and/or in evaluating the terms of the Business Combination. Additionally, given that the PNAC Initial Stockholders collectively acquired 1,612,500 PNAC Founder Shares at a purchase price of approximately \$0.016 per share and 398,892 PNAC Private Shares at a purchase price of \$10.00 per share, representing 29.05% of issued and outstanding shares of PNAC Common Stock prior to the Business Combination, and the noco-noco Valuation of \$1,350,000,000 based on the redemption price of \$10.34 per share, the PNAC Initial Stockholders could make a substantial profit after the Business Combination from their acquisition of PNAC Founder Shares and/or PNAC Private Shares as discussed above, even if the Business Combination subsequently declines in value or is unprofitable for the PNAC Public Stockholders, or the PNAC Public Stockholders experience substantial losses in their investment in PubCo. In considering these facts and the other information contained in this proxy statement/prospectus, you should be aware that PNAC Initial Stockholders and PNAC's directors and officers may have financial interests in the Business Combination that may be different from, or in addition to, the interests of PNAC Public Stockholders.

Furthermore, in order to finance transaction costs in connection with an intended initial business combination, the Founders, an affiliate of the Founders, or certain of PNAC's officers and directors may, but are not obligated to, loan PNAC funds as may be required. If PNAC completes the Business Combination, PNAC would repay such Working Capital Loans out of the proceeds of the Trust Account released to PNAC. Otherwise, such Working Capital Loans would be repaid only out of funds held outside the Trust Account. In the event that the Business Combination does not close, PNAC may use a portion of the working capital held outside the Trust Account to repay such loaned amounts but no proceeds from the Trust Account would be used to repay such loaned amounts. Up to \$3,000,000 of such loans may be convertible into the Working Capital Shares, at a price of \$10.00 per share at the option of the lender. As of March 31, 2023, PNAC had no borrowings under the Working Capital Loans. In case any borrowing is incurred, such outstanding working capital loans may also influence the PNAC shareholders' decision to approve the Business Combination.

Furthermore, the PNAC Initial Stockholders are entitled to reimbursement of out-of-pocket expenses incurred by them related to identifying, investigating, and consummating an initial business combination. Any such expenses will be repaid upon completion of the Business Combination with noco-noco. [As of the date of this proxy statement/prospectus, no such reimbursable expenses have been incurred.] If any such expenses are incurred, however, if PNAC fails to consummate the Business Combination, they will not have any claim against the Trust Account for repayment or reimbursement. Accordingly, PNAC may not be able to repay or reimburse these amounts if the Business Combination is not completed.

Officers of PNAC negotiated the terms of the Business Combination Agreement with their counterparts at noco-noco, and the Board considered these interests, among other matters, when making the determination that the Business Combination is advisable and fair to, and in the best interests of, PNAC and its unaffiliated stockholders. See the section entitled "*Proposal 1: The Business Combination Proposal— Interests of PNAC's Directors and Officers in the Business Combination*" of this proxy statement/prospectus for a detailed discussion of the special interests that the PNAC Initial Stockholders and PNAC's directors and officers may have in the Business Combination.

***Our actual financial position and results of operations may differ materially from the unaudited pro forma financial information included in this proxy statement/prospectus.***

The unaudited pro forma condensed combined financial information in this proxy statement/prospectus is presented for illustrative purposes only and is not necessarily indicative of what our actual financial position or results of operations would have been had the Business Combination been completed on the dates indicated. The preparation of the pro forma financial information is based upon available information and certain assumptions and estimates that PNAC and noco-noco currently believe are reasonable. The unaudited pro forma condensed combined information does not purport to indicate the results that would have been obtained had the Business Combination and related transactions actually been completed on the assumed date or for the periods presented, or which may be realized in the future. The pro forma adjustments are based on the information currently available and the assumptions and estimates underlying the pro forma adjustments are described in the accompanying notes. Actual results may differ materially from the assumptions within the accompanying unaudited pro forma condensed combined financial information. See "*Unaudited Pro Forma Condensed Combined Financial Information*" for more information.

***We do not have a specified maximum redemption threshold. The absence of such a redemption threshold may make it possible for us to complete the Business Combination with which a substantial majority of our stockholders do not agree.***

The Existing PNAC Charter does not provide a specified maximum redemption threshold, except that in no event will PNAC redeem the PNAC Public Shares in an amount that would cause its net tangible assets, to be less than \$5,000,001 either immediately prior to or upon the consummation of a business combination after taking into account the redemption for cash of all PNAC Public Shares properly demanded to be redeemed by holders of PNAC Common Stock (such that we do not then become subject to the SEC's "penny stock" rules), or any greater net tangible asset or cash requirement that may be contained in the agreement relating to PNAC's initial business combination. As a result, PNAC may be able to complete the Business Combination even though a substantial majority of the PNAC Public Stockholders do not agree with the Business Combination and have redeemed their shares in connection with the consummation of the Business Combination. In the event that the aggregate redemption requests we would be required to pay for all PNAC Common Stock that are validly submitted for redemption plus any amount required to satisfy cash conditions pursuant to the terms of the Business Combination Agreement exceed the aggregate amount of cash available to PNAC, PNAC will not complete the Business Combination or redeem any shares, all PNAC Public Shares submitted for redemption will be returned to the holders thereof, and PNAC instead may search for an alternate business combination, provided PNAC still has time to complete an alternative business combination under the Existing PNAC Charter.

***PNAC Public Stockholder will have a reduced ownership and voting interest after the Business Combination and will exercise less influence over management.***

Upon the issuance of PubCo Ordinary Shares to noco-noco shareholders, current PNAC Public Stockholders percentage ownership will be diluted. Immediately following the Closing and excluding shares of PNAC Common Stock issuable upon the exercise of PubCo Warrants, (i) assuming that no PNAC Public Stockholders exercise their redemption rights, current PNAC Public Stockholders percentage ownership in PubCo would be [4.12%], (ii) assuming that PNAC Public Stockholders holding 25% of PNAC Public Shares exercise their redemption rights, current PNAC Public Stockholders' percentage ownership in PubCo would be [3.27]%, (iii) assuming that PNAC Public Stockholders holding 75% of the PNAC Public Shares exercise their redemption rights, current PNAC Public Stockholders' percentage ownership in PubCo would be [1.51]%, and (iv) assuming that a maximum of PNAC Public Shares issued and outstanding as of the Record Date are redeemed, current PNAC Public Stockholders' percentage ownership in PubCo would be [0.60]%. Additionally, of the expected 7 members of the board of directors of PubCo, all will be current directors of noco-noco or designated by noco-noco. The percentage of the issued and outstanding PubCo Ordinary Shares that will be owned by current PNAC Public Stockholders as a group will vary based on the number of shares of PNAC Common Stock redeemed in connection with the Business Combination. Because of the above, current PNAC Public Stockholders, as a group, will have less influence on the board of directors, management, and policies of PubCo than they now have on the Board, management, and policies of PNAC. See the section entitled "*Security Ownership of Certain Beneficial Owners and Management*" of this proxy statement/prospectus for an illustration of the number of shares and percentage interests outstanding under scenarios that assume no redemptions and redemptions of PNAC Public Shares in the maximum amount.

***PNAC may redeem the unexpired PNAC Warrants prior to their exercise at a time that is disadvantageous to you, thereby making your PNAC Warrants worthless.***

PNAC has have ability to redeem outstanding PNAC Warrants at any time after they become exercisable and prior to their expiration, at a price of \$0.01 per warrant, provided that the last reported sales price of PNAC Class A Common Stock equals or exceeds \$16.50 per share (as adjusted for stock splits, stock dividends, reorganizations, recapitalizations and the like) for any 20 trading days within a 30 trading-day period ending on the third business day prior to the date on which PNAC gives proper notice of such redemption and provided certain other conditions are met. While PNAC Class A Common Stock has not exceeded the \$16.50 per share threshold at which PNAC Warrants would become redeemable since the announcement of the Business Combination, there is no assurance that the price of PubCo Ordinary Shares will not exceed the threshold in the future. If and when the PNAC Warrants become redeemable by PNAC, PNAC may exercise its redemption right even if PNAC is unable to register or qualify the underlying securities for sale under all applicable state securities laws.

Notice of redemption shall be mailed by first class mail, postage prepaid, by PNAC not less than thirty (30) days prior to the date that fixed by PNAC for the redemption to the registered holders of the PNAC Warrants to be redeemed at their last addresses as they shall appear on the registration books. Any notice mailed in the manner herein provided shall be conclusively presumed to have been duly given whether or not the registered holder received such notice. PNAC will not redeem the PNAC Warrants unless a registration statement under the Securities Act covering the shares of PNAC Common Stock issuable upon exercise of the PNAC Warrants is effective and a current prospectus relating to those shares of PNAC Common Stock is available throughout the 30-day redemption period, except if the PNAC Warrants may be exercised on a cashless basis and such cashless exercise is exempt from registration under the Securities Act. If and when the PNAC Warrants become redeemable by PNAC, PNAC may exercise its redemption right even if PNAC is unable to register or qualify the underlying securities for sale under all applicable state securities laws. If PNAC elect to redeem the PNAC Warrants on a cashless basis, then PNAC will not receive any cash proceeds from the exercise of such PNAC.

Redemption of the outstanding PNAC Warrants could force you (i) to exercise PNAC Warrants and pay the exercise price therefor at a time when it may be disadvantageous for you to do so, (ii) to sell PNAC Warrants at the then-current market price when you might otherwise wish to hold PNAC Warrants or (iii) to accept the nominal redemption price which, at the time the outstanding PNAC Warrants are called for redemption, is likely to be substantially less than the market value of PNAC Warrants.

***If the Business Combination's benefits do not meet the expectations of investors, stockholders or financial analysts, the market price of the PNAC Common Stock before the Closing and PubCo Ordinary Shares post closing may decline.***

If the benefits of the Business Combination do not meet the expectations of investors or securities analysts, the market price of PNAC Common Stock prior to the Closing may decline. The market value of PNAC Common Stock at the time of the Business Combination may vary significantly from its price on the date the Business Combination Agreement was executed, the date of this proxy statement/prospectus, or the date on which PNAC Public Stockholders vote on the Business Combination.

In addition, following the Business Combination, fluctuations in the price of PubCo Ordinary Shares could contribute to the loss of all or part of your investment. Any of the factors listed below could have a material adverse effect on your investment in PubCo Ordinary Shares and PubCo Ordinary Shares may trade at a price significantly below the price you paid for it. In such circumstances, the trading price of PubCo Ordinary Shares may not recover and may experience a further decline.

Factors affecting the trading price of PubCo Ordinary Shares following the Business Combination may include:

- actual or anticipated fluctuations in PubCo quarterly financial results or the quarterly financial results of companies perceived to be similar to PubCo;
- changes in the market's expectations about PubCo's operating results;

- success of competitors;
- PubCo's operating results failing to meet the expectation of securities analysts or investors in a particular period;
- changes in financial estimates and recommendations by securities analysts concerning PubCo or the market in general;
- operating and stock price performance of other companies that investors deem comparable to PubCo;
- changes in laws and regulations affecting PubCo's business;
- commencement of, or involvement in, litigation involving PubCo;
- changes in PubCo's capital structure, such as future issuances of securities or the incurrence of additional debt;
- the volume of shares available for public sale;
- any major change in the board of directors or management of PubCo;
- sales of substantial amounts of securities by PubCo's directors, executive officers, or significant stockholders or the perception that such sales could occur;
- general economic and political conditions such as recessions, interest rates, fuel prices, international currency fluctuations, and acts of war or terrorism; and
- other developments affecting the industry.

Broad market and industry factors may materially harm the market price of PubCo Ordinary Shares irrespective of our operating performance. The stock market in general and Nasdaq have experienced price and volume fluctuations that have often been unrelated or disproportionate to the operating performance of the particular companies affected. The trading prices and valuations of these stocks, and of PubCo's securities, may not be predictable. A loss of investor confidence in the market for retail stocks or the stocks of other companies, notably in the industry which investors perceive to be similar to PubCo could depress PubCo's stock price regardless of its business, prospects, financial conditions or results of operations. A decline in the market price for PubCo Ordinary Shares also could adversely affect PubCo's ability to issue additional securities and PubCo's ability to obtain additional financing in the future.

***PNAC's directors may decide not to enforce the indemnification obligations of the Sponsors, resulting in a reduction in the amount of funds in the Trust Account available for distribution to the Public Stockholders.***

The Sponsors have agreed that it will be liable to PNAC if and to the extent any claims by a third party for services rendered or products sold to PNAC, or a prospective target business with which we have entered into a written letter of intent, confidentiality or other similar agreement or business combination agreement, reduce the amount of funds in the Trust Account to below the lesser of (i) \$10.20 per Public Share and (ii) the actual amount per PNAC Public Share held in the Trust Account as of the date of the liquidation of the Trust Account, if less than \$10.20 per public share due to reductions in the value of the trust assets, less taxes payable, provided that such liability will not apply to any claims by a third party or prospective target business who executed a waiver of any and all rights to the funds held in the Trust Account (whether or not such waiver is enforceable) nor will it apply to any claims under PNAC's indemnity of the underwriter of the PNAC IPO against certain liabilities, including liabilities under the Securities Act. However, PNAC has not asked the Sponsors to reserve for such indemnification obligations, nor has PNAC independently verified whether the Sponsors have sufficient funds to satisfy its indemnity obligations and believe that the Sponsors' only assets are securities of PNAC. Therefore, we cannot provide any assurance that the Sponsors would be able to satisfy those obligations. None of PNAC officers or directors will indemnify PNAC for claims by third parties including, without limitation, claims by vendors and prospective target businesses.

If the Sponsors assert that it is unable to satisfy its indemnification obligations or that it has no indemnification obligations related to a particular claim, our independent directors would determine whether to take legal action against the Sponsor to enforce its indemnification obligations. While we currently expect that PNAC's independent directors would take legal action on behalf of PNAC against the Sponsors to enforce its indemnification obligations to PNAC, it is possible that PNAC's independent directors, in exercising their business judgment, may choose not to do so if, for example, the cost of such legal action is deemed by the independent directors to be too high relative to the amount recoverable or if the independent directors determine that a favorable outcome is not likely. PNAC has not asked the Sponsors to reserve for such indemnification obligations and we cannot provide any assurance that the Sponsors would be able to satisfy those obligations. Accordingly, we cannot provide any assurance that due to claims of creditors the actual value of the per-share redemption price will not be less than \$10.20 per Public Share.

***Members of our management team may in the future be involved in governmental investigations and civil litigation relating to the business affairs of companies with which they are, were or may in the future be affiliated.***

Members of our management team may in the future be involved in governmental investigations and civil litigation relating to the business affairs of companies with which they are, were or may in the future be affiliated. Any such investigations or litigations may divert our management team's attention and resources away from consummating the Business Combination, may be detrimental to our reputation, and thus may negatively affect our ability to complete the Business Combination.

***PNAC may become involved in litigation that may materially adversely affect us.***

From time to time, we may become involved in various legal proceedings relating to matters incidental to the ordinary course of our business, including litigation and claims and governmental and other regulatory investigations and proceedings. Such matters can be time-consuming, divert management's attention and resources, cause us to incur significant expenses or liability or require us to change our business practices.

Because of the potential risks, expenses, and uncertainties of litigation, we may, from time to time, settle disputes, even where we believe that we have meritorious claims or defences. Because litigation is inherently unpredictable, we cannot assure you that the results of any of these actions will not have a material adverse effect on our business.

The securities price of PNAC may be volatile and, in the past, companies that have experienced volatility in the market price of their stock have been subject to securities litigation, including class action litigation. We may be the target of this type of litigation in the future.

Litigation of this type could result in substantial costs and diversion of management's attention and resources, which could have a material adverse effect on our business, financial condition, and results of operations. Any adverse determination in litigation could also subject us to significant liabilities.

***After the consummation of the Business Combination, all but of the executive officers and directors of PubCo are expected to be located in the United States and therefore, investors may not be able to enforce federal securities laws or their other legal rights upon such officers of PubCo located outside the United States.***

All of the current directors and officers of noco-noco are located in the United States. Following the consummation of the Business Combination, all of the executive officers and directors of noco-noco are expected to be located in the United States. As a result, it may be difficult, or in some cases not possible, for investors in the United States or to enforce their legal rights, to effect service of process upon such officers and director of PNAC located outside the United States, to enforce judgments of the United States courts predicated upon civil liabilities and criminal penalties on such director under United States securities laws.

***The Business Combination is subject to conditions, including certain conditions that may not be satisfied on a timely basis, if at all.***

The completion of the Business Combination is subject to a number of conditions. The completion of the Business Combination is not assured and is subject to risks, including the risk that approval of the Business Combination by PNAC stockholders is not obtained or that there are not sufficient funds in the Trust Account, in each case subject to certain terms specified in the Business Combination Agreement (as described in the section entitled “*The Business Combination Proposal—The Business Combination Agreement—Conditions to Closing.*”). If PNAC does not complete the Business Combination, PNAC could be subject to several risks, including:

- the parties may be liable for damages to one another under the terms and conditions of the Business Combination Agreement;
- negative reactions from the financial markets, including declines in the price of our PNAC Common Stock because current prices reflect a market assumption that the Business Combination will be completed;
- the attention of our management will have been diverted to the Business Combination rather than the pursuit of other opportunities in respect of an initial business combination; and
- we will have a limited period of time, if any, to complete an alternative initial business combination and we may not be as attractive to potential alternative partners to an initial business combination if we are unable to complete the Business Combination.

***Either PNAC or noco-noco may waive one or more of the conditions to the Business Combination or certain of the other transactions contemplated by the Business Combination Agreement.***

Either PNAC or noco-noco may agree to waive, in whole or in part, some of the conditions to its obligations to consummate the Business Combination or certain of the other transactions contemplated by the Business Combination Agreement, to the extent permitted by the Existing PNAC Charter and applicable laws. For example, it is a condition to PNAC’s obligations to consummate the Business Combination that certain of noco-noco’s representations and warranties are true and correct in all respects as of the date of Closing, except where the failure of such representations and warranties to be true and correct, individually or in the aggregate, have not had and would not reasonably be expected to have a material adverse effect. However, if the Board determines that it is in the best interest of PNAC stockholders to waive any such breach, then the Board may elect to waive that condition and consummate the Business Combination.

The existence of financial and personal interests of one or more of PNAC’s directors may result in a conflict of interest on the part of such director(s) between what such director(s) may believe is in the best interests of PNAC and its stockholders and such director(s) may believe is best for such director(s) in determining to recommend that stockholders vote for the proposals. In addition, PNAC’s officers have interests in the Business Combination that may conflict with your interests as a stockholder. As of the date of this proxy statement/prospectus, PNAC does not believe there will be any changes or waivers that its directors and officers would be likely to make after stockholder approval of the Business Combination has been obtained. While certain changes could be made without further stockholder approval, if there were a change to the terms of the transaction that would have a material impact on the stockholders, PNAC will be required to circulate a new or amended proxy statement/prospectus or supplement thereto and resolicit the vote of its stockholders with respect to the Business Combination Proposal. See the section entitled “*The Business Combination Proposal— Interests of PNAC’s Directors and Officers in the Business Combination.*” of this proxy statement/prospectus for a further discussion of these considerations.

***Termination of the Business Combination Agreement could negatively impact PNAC and noco-noco.***

If the Business Combination is not completed for any reason, including as a result of PNAC stockholders declining to approve the Proposals required to effect the Business Combination, the ongoing businesses of PNAC and noco-noco may be adversely impacted and, without realizing any of the anticipated benefits of completing the Business Combination, PNAC and noco-noco would be subject to a number of risks, including the following:

- PNAC or noco-noco may experience negative reactions from the financial markets, including negative impacts on the price of PNAC’s securities (including to the extent that the current market price reflects a market assumption that the Business Combination will be completed);
- PNAC currently has until July 17, 2023 (or by November 17, 2023, if extended) to complete its initial business combination. This deadline may be extended by approval of PNAC stockholders in an amendment to its Existing PNAC Charter, but such an amendment would cause PNAC to incur substantial expenses to seek additional extension(s) and face increased risk to unwind and liquidate if it does not complete its initial business combination by July 17, 2023 (or by November 17, 2023, if extended, or such later date as may be approved by PNAC stockholders in an amendment to its Existing PNAC Charter);
- noco-noco may experience negative reactions from its investors;
- PNAC and noco-noco will have incurred substantial expenses and will be required to pay certain costs relating to the Business Combination, whether or not the Business Combination is consummated; and
- since the Business Combination Agreement restricts the conduct of PNAC’s and noco-noco’s businesses prior to completion of the Business Combination, each of PNAC and noco-noco may not have been able to take certain actions during the pendency of the Business Combination that would have benefitted it as an independent company, and the opportunity to take such actions may no longer be available (see the sections entitled “*The Business Combination Proposal*” and “*Summary of the Proxy Statement/Prospectus — Covenants and Agreements of the Parties*” of this proxy statement/prospectus for a description of the restrictive covenants applicable to PNAC and noco-noco).

If the Business Combination Agreement is terminated and the Board seeks another merger or business combination, PNAC stockholders cannot be certain that PNAC will be able to find another acquisition target that would constitute a business combination or that such other merger or business combination will be completed. See the sections entitled “*The Business Combination Proposal — Termination*” of this proxy statement prospectus for additional information.

***The listing of PubCo’s securities on Nasdaq will not benefit from the process undertaken in connection with an underwritten initial public offering.***

Upon the Closing, we intend to list the PubCo Ordinary Shares on Nasdaq under the symbol “ ” and “ .” respectively. Unlike an underwritten initial public offering of PubCo’s securities, the listing of PubCo’s securities as a result of the Business Combination will not benefit from the following:

- the book-building process undertaken by underwriters, which helps to inform efficient price discovery with respect to opening trades of newly listed securities;



- underwriter support to help stabilize, maintain, or affect the public price of the securities immediately after listing; and
- underwriter due diligence review of the offering and potential liability for material misstatements or omissions of fact in a prospectus used in connection with the securities being offered, or for statements made by its securities analysts or other personnel.

The lack of such a process in connection with the listing of PubCo's securities could result in diminished investor demand, inefficiencies in pricing and a more volatile public price for PubCo's securities during the period immediately following the listing than would typically be experienced in connection with an underwritten initial public offering.

***The ability of PNAC stockholders to exercise redemption rights with respect to a large number of shares of PNAC Common Stock could increase the probability that the Business Combination would be unsuccessful and that PNAC stockholders would have to wait for liquidation in order to redeem their shares of PNAC Common Stock.***

At the time we entered into the Business Combination Agreement and related transaction documents, we did not know how many stockholders would exercise their redemption rights, and therefore we structured the Business Combination based on our expectations as to the number of shares that will be submitted for redemption. The Business Combination Agreement requires us to have at least \$5,000,001 of net tangible assets upon the consummation of the Business Combination, after giving effect to redemptions of PNAC Public Shares, if any, but before any transaction expenses. If a larger number of shares are submitted for redemption than we initially expected, this may limit our ability to complete the Business Combination or optimize our capital structure.

***The consummation of the Business Combination is conditioned on, among other things, there being at least \$20.0 million in Available PNAC Cash at the Closing. There is no guarantee that there will be \$20.0 million Available PNAC Cash at the Closing. As this condition is for noco-noco's benefit, it is possible that noco-noco could waive them prior to the Closing, subject to compliance with applicable Nasdaq listing requirements, although there is no guarantee that it would. If noco-noco did waive these conditions in these circumstances, it is possible that PubCo would have insufficient capital to conduct and grow its business after the Closing in the manner described in this proxy statement/prospectus or that PubCo would not be able to meet applicable Nasdaq listing requirements.***

Pursuant to the Business Combination Agreement, among other things, consummation of the Business Combination is subject to the satisfaction or waiver by the respective parties of a number of conditions, including without limitation, the Available PNAC Cash at the Closing being no less than \$20.0 million equal to the amount of cash available in the Trust Account following the Special Meeting, after deducting the amount required to satisfy the redemption by the PNAC Public Stockholders but prior to the payment of any deferred underwriting commissions being held in the Trust Account and the payment of any noco-noco Transaction Expenses or PNAC Transaction Expenses. It is uncertain how many PNAC stockholders might redeem their PNAC Public Shares, how many expenses will be incurred in connection with the Business Combination. As these conditions are for noco-noco's benefit, it is possible that noco-noco could waive them prior to the Closing, subject to compliance with applicable Nasdaq listing requirements, although there is no guarantee that it would. If noco-noco did waive these conditions in these circumstances, it is possible that PubCo would have insufficient capital to conduct and grow its business after the Closing in the manner described in this proxy statement/prospectus or that PubCo would not be able to meet applicable Nasdaq listing requirements.

***There is no guarantee that a stockholder's decision to continue to hold shares of PubCo Ordinary Shares following the Business Combination will put the stockholder in a better future economic position than if they decided to redeem their PNAC Public Shares for a pro rata portion of the Trust Account, and vice versa.***

PNAC and PubCo can give no assurance as to the price at which a stockholder may be able to sell its PubCo Ordinary Shares in the future following the completion of the Business Combination or any alternative business combination. Certain events following the consummation of any initial business combination, including the Business Combination, may cause an increase in PNAC's share price, and may result in a lower value realized now than a stockholder of PNAC might realize in the future had the stockholder redeemed their shares. Similarly, if a stockholder does not redeem their shares, the stockholder will bear the risk of ownership of the PNAC Public Shares after the consummation of any initial business combination, including the Business Combination, and there can be no assurance that a stockholder can sell its shares in the future for a greater amount than the redemption price set forth in this proxy statement/prospectus. A stockholder should consult the stockholder's own tax and/or financial advisor for assistance on how this may affect such stockholder's individual situation.

***If PNAC stockholders fail to comply with the redemption requirements specified in this proxy statement/ prospectus, they will not be entitled to redeem their PNAC Class A Common Stock for a pro rata portion of the funds held in the Trust Account.***

To exercise their redemption rights, holders of PNAC Class A Common Stock are required to deliver their shares, either physically or electronically using Depository Trust Company's DWAC System, to PNAC's transfer agent prior to the vote at the Special Meeting. If a Public Stockholder fails to properly seek redemption as described in this proxy statement/prospectus and the Business Combination is consummated, such holder will not be entitled to redeem these shares for a pro rata portion of funds deposited in the Trust Account. See the section entitled "*Special Meeting of PNAC stockholders—Redemption Rights*" for additional information on how to exercise your redemption rights.

Stockholders of PNAC who wish to redeem their shares for a pro rata portion of the Trust Account must comply with specific requirements for redemption that may make it more difficult for them to exercise their redemption rights prior to the deadline.

Public Stockholders who wish to redeem their shares for a pro rata portion of the Trust Account must, among other things, as fully described in the section entitled "*Special Meeting of PNAC stockholders—Redemption Rights*," deliver their shares (either physically or electronically) to VStock (or through DTC to VStock) prior to

***If you or a "group" of stockholders of which you are a part are deemed to hold an aggregate of more than 15% of the aggregate PNAC Public Shares, you (or, if a member of such a group, all of the members of such group in the aggregate) will lose the ability to redeem all such shares in excess of 15% of the PNAC Public Shares.***

A PNAC Public Stockholder, together with any of such PNAC Public Stockholder's affiliates or any other person with whom such PNAC Public Stockholder is acting in concert or as a "group" (as defined under Section 13 of the Exchange Act), will be restricted from redeeming in the aggregate such Public Stockholder's shares or, if part of such a group, the group's shares, with respect to 15% or more of the aggregate PNAC Public Shares. In order to determine whether a stockholder is acting in concert or as a group with another stockholder, PNAC will require each PNAC Public Stockholder seeking to exercise redemption rights to certify to PNAC whether such stockholder is acting in concert or as a group with any other stockholder. Such certifications, together with other public information relating to stock ownership available to PNAC at that time, such as Section 13D, Section 13G and Section 16 filings under the Exchange Act, will be the sole basis on which PNAC makes the above-referenced determination. Your inability to redeem any such excess shares will reduce your influence over PNAC's ability to consummate the Business Combination and you could suffer a material loss on your investment in PNAC if you sell such excess shares in open market transactions. Additionally, PNAC Public Stockholders will not receive redemption distributions with respect to such excess shares if PNAC consummates the Business Combination. As a result, you will continue to hold that number of shares aggregating to more than 15% of the PNAC Public Shares and, in order to dispose of such excess shares, would be required to sell your stock in open market transactions, potentially at a loss. While PNAC Class A Common Stock has not exceeded the \$16.50 per-share redemption price, PNAC cannot assure you that the value of such excess shares will appreciate over time following the Business Combination or that the market price of PNAC Common Stock will exceed the per-share redemption price. Notwithstanding the foregoing, stockholders may challenge PNAC's determination as to whether a stockholder is acting in concert or as a group with another stockholder in a court of competent jurisdiction.

However, PNAC Public Stockholders' ability to vote all of their shares (including such excess shares) for or against the Business Combination is not restricted by this limitation on redemption.

***PNAC Public Stockholders will not have any rights or interests in funds from the Trust Account, except under certain limited circumstances. To liquidate your investment, therefore, Public Stockholders may be forced to sell their PNAC Public Shares and/or PNAC Warrants, potentially at a loss.***

Public Stockholders will be entitled to receive funds from the Trust Account only upon the earlier to occur of: of (1) the completion of PNAC's initial business combination, and then only in connection with those shares of PNAC Common Stock that such shareholders properly elected to redeem, subject to the limitations described herein, (2) the redemption of any PNAC Public Shares properly tendered in connection with a shareholder vote to amend the Existing PNAC Charter (A) to modify the substance or timing of PNAC's obligation to provide holders of PNAC Common Stock the right to have their shares redeemed in connection with PNAC's initial business combination or to redeem 100% of PNAC Public Shares if PNAC does not complete its initial business combination by July 17, 2023 (or by November 17, 2023, if extended) or (B) with respect to any other provision relating to the rights of holders of PNAC Common Stock, and (3) the redemption of PNAC Public Shares if it has not consummated its business combination by the Final Redemption Date, subject to applicable law. In no other circumstances will a Public Stockholder have any right or interest of any kind in the Trust Account. Holders of the PNAC Warrants and PNAC Rights will not have any right to the proceeds held in the Trust Account with respect to the PNAC Warrants or PNAC Rights. Accordingly, to liquidate your investment, you may be forced to sell your PNAC Public Shares, PNAC Warrants, or PNAC Rights potentially at a loss.

***If PNAC is deemed to be an investment company under the Investment Company Act, PNAC may be required to institute burdensome compliance requirements and PNAC's activities may be restricted, which may make it difficult for PNAC to complete PNAC's initial business combination.***

If PNAC is deemed to be an investment company under the Investment Company Act, PNAC's activities may be restricted, including:

- restrictions on the nature of PNAC's investments; and
- restrictions on the issuance of securities; each of which may make it difficult for PNAC to complete PNAC's initial business combination.

In addition, PNAC may have imposed upon PNAC burdensome requirements, including:

- registration as an investment company;
- adoption of a specific form of corporate structure; and
- reporting, record keeping, voting, proxy, and disclosure requirements and other rules and regulations.

PNAC does not believe that PNAC's anticipated principal activities will subject PNAC to the Investment Company Act.

The proceeds held in the Trust Account may be invested by the trustee only in United States government treasury bills with a maturity of 185 days or less or in money market funds investing solely in United States Treasuries and meeting certain conditions under Rule 2a-7 under the Investment Company Act. Because the investment of the proceeds will be restricted to these instruments, PNAC believes PNAC will meet the requirements for the exemption provided in Rule 3a-1 promulgated under the Investment Company Act. If PNAC was deemed to be subject to the Investment Company Act, compliance with these additional regulatory burdens would require additional expenses for which PNAC has not allotted funds and may hinder PNAC's ability to complete a business combination. If PNAC is unable to complete PNAC's initial business combination, PNAC Public Stockholders may receive only approximately \$10.20 per share, or less in certain circumstances, on the liquidation of PNAC's Trust Account and PNAC Warrants will expire worthless.

***We may not be able to complete the Business Combination if it is subject to U.S. foreign investment regulations and review by a U.S. government entity such as the Committee on Foreign Investment in the United States (CFIUS), or ultimately prohibited.***

CFIUS is an interagency committee authorized to review certain transactions involving foreign investment in the United States by foreign persons in order to determine the effect of such transactions on the national security of the United States. Whether CFIUS has jurisdiction to review an acquisition or investment transaction depends on, among other factors, the nature and structure of the transaction, including the level of beneficial ownership interest and the nature of any information or governance rights involved.

For example, investments that result in “control” of a “U.S. business” by a “foreign person” (in each case, as such terms are defined in 31 C.F.R. Part 800) that might be considered by CFIUS to be a covered transaction that CFIUS would have authority to review. Some of our directors and officers, and members of our Sponsors, are “foreign persons” as defined under the relevant regulations. Specifically:

- Among our management, Mr. Dongfeng Wang, PNAC’s Chairman and Chief Executive Officer, is located in the U.S. and a U.S. permanent resident, and a Hong Kong citizen. Mr. Weixiong (Jeff) Cheong, PNAC’s Chief Operating Officer, is located outside U.S. and a Singapore citizen. Other than Mr. Wang and Mr. Cheong, the rest of our directors and officers are U.S. citizens residing in the U.S.
- Sponsor A, Prime Number Acquisition LLC, currently holding 25.03% of PNAC’s outstanding shares, is managed by Mr. Wang, and owned directly or indirectly by (excluding 445,000 shares of Class A Common Stock reserved for certain advisory shares as provided in PNAC’s IPO prospectus (File No. 333-262457) filed with the SEC on May 17, 2022):
  - o Mr. Wang, who owns 49,660 Class X Units and 219,635 Class Y Units of Membership Interests in Sponsor A, is entitled to receive the distribution of an equivalent of 269,294 shares of PNAC Class A Common Stock, or 3.89% of PNAC’s outstanding shares;
  - o Mr. Cheong, who, via a holding entity, owns 110,996 Class X Units and 336,565 Class Y Units of Membership Interests in Sponsor A, is entitled to receive the distribution of an equivalent of 447,561 shares of PNAC Class A Common Stock, or 6.46% of PNAC’s outstanding shares;
  - o Zhi Li, a PRC citizen, who, via a holding entity, owns 64,563.5 Class X Units and 130,781 Class Y Units of Membership Interests in Sponsor A, is entitled to receive the distribution of an equivalent of 195,435 shares of PNAC Class A Common Stock, or 2.82% of PNAC’s outstanding shares;
  - o Hui Xian, a Hong Kong citizen, who, via a holding entity, owns 64,563.5 Class X Units and 130,781 Class Y Units of Membership Interests in Sponsor A, is entitled to receive the distribution of an equivalent of 195,435 shares of PNAC Class A Common Stock, or 2.82% of PNAC’s outstanding shares;
  - o Charlie Lu, a U.S. citizen, who, via a holding entity, owns 49,313 Class X Units and 99,958 Class Y Units of Membership Interests in Sponsor A, is entitled to receive the distribution of an equivalent of 149,271 shares of PNAC Class A Common Stock, or 2.16% of PNAC’s outstanding shares;
  - o Shenghui Yang, a PRC citizen, who owns 4,968 Class X Units and 10,400 Class Y Units of Membership Interests in Sponsor A, is entitled to receive the distribution of an equivalent of 15,368 shares of PNAC Class A Common Stock, or 0.22% of PNAC’s outstanding shares; and
  - o Guangrui He, a PRC citizen, who owns 4,968 Class X Units and 10,400 Class Y Units of Membership Interests in Sponsor A, is entitled to receive the distribution of an equivalent of 15,368 shares of PNAC Class A Common Stock, or 0.22% of PNAC’s outstanding shares.
- Sponsor B, Glorious Capital LLC, currently holding 2.02% of PNAC’s outstanding shares, is managed by Benedicto S. Perez, a U.S. citizen, and owned directly or indirectly by:
  - o Charlie Lu, a U.S. citizen, who, via a holding entity, owns 24,930 Class X Units and 45,150 Class Y Units of Membership Interests in Sponsor B, is entitled to receive the distribution of an equivalent of 70,080 shares of PNAC Class A Common Stock, or 1.01% of PNAC’s outstanding shares;
  - o Guangrui He, a PRC citizen, who owns 24,930 Class X Units and 45,150 Class Y Units of Membership Interests in Sponsor B, is entitled to receive the distribution of an equivalent of 70,080 shares of PNAC Class A Common Stock, or 1.01% of PNAC’s outstanding shares.

As a result, an aggregate of 1,208,541 shares, or 17.46% of PNAC’s outstanding shares are held indirectly by non-U.S. persons or persons with foreign citizenship. PNAC is therefore likely considered a “foreign person” under the regulations administered by CFIUS and will continue to be considered as such in the future for so long as the Sponsors have the ability to exercise control over PNAC for purposes of CFIUS’s regulations. Therefore, it could be subject to foreign ownership restrictions and/or CFIUS review if noco-noco is considered to be engaged in a regulated industry or which may affect national security.

Moreover, the scope of CFIUS review was expanded by the Foreign Investment Risk Review Modernization Act of 2018 (“FIRRMA”), to include certain non-passive, non-controlling investments in sensitive U.S. businesses and certain acquisitions of real estate even with no underlying U.S. business. FIRRMA’s implementing regulations, which became effective on February 13, 2020, expanded the scope of CFIUS’s jurisdiction to investments that do not result in control of a U.S. business by a foreign person but afford certain foreign investors certain information or governance rights in a U.S. business that has a nexus to “critical technologies,” “critical infrastructure” and/or “sensitive personal data.” In addition, the implementing regulations also subjects certain categories of investments to mandatory filings. If noco-noco’s business falls within CFIUS’s jurisdiction, we may determine that we are required to make a mandatory filing or that we will submit a voluntary notice to CFIUS, or to proceed with the initial business combination without notifying CFIUS and risk CFIUS intervention, before or after closing the Business Combination. CFIUS may decide to block or delay the Business Combination, impose conditions to mitigate national security concerns with respect to the Business Combination or order us to divest all or a portion of PubCo’s business without first obtaining CFIUS clearance.

As a result of, and upon consummation of the Business Combination, each of PNAC and noco-noco shall become a subsidiary of PubCo, and PubCo shall become a new public company owned by the prior holders of PNAC Common Stock, the prior holders of PNAC Rights, the prior holders of PNAC Warrants, the Sellers, and certain third-party investors of a financing in connection with the Business Combination. PubCo is a holding company incorporated in the Cayman Islands. In addition, noco-noco’s businesses are substantially based in Singapore, with projects and operations in Australia and PNG, and potentially, in Philippines, Indonesia, India, or Thailand in the near future. As a result, we do not expect the Business Combination to result in “control” of a “U.S. business” by a “foreign person.” under the regulations administered by CFIUS. Additionally, we do not expect the business of PNAC to be deemed to have a nexus to “critical technologies,” “covered investment critical infrastructure,” and/or “sensitive personal data” under the regulations administered by CFIUS.

Notwithstanding the above, if our determination is not correct, or if the regulations change or are interpreted differently in the future, the Business Combination may be subject to CFIUS review or review by another U.S. governmental entity and ultimately prohibited. Even if it not prohibited, any review by CFIUS or another government entity may have outsized impacts on, among other things, the certainty, timing and feasibility of the Business Combination, which would significantly limit or completely hinder our ability to complete the Business Combination and force PNAC to liquidate and our warrants and rights to expire worthless, preventing the possibility of any price appreciation that may have occurred in our securities following the Business Combination.

The process of government review, whether by the CFIUS or otherwise, could be lengthy and PNAC has limited time to complete the Business Combination. If PNAC cannot complete the Business Combination by November 17, 2023 (assuming full extension) because the review process drags on beyond such timeframe or because the Business Combination is ultimately prohibited by CFIUS or another U.S. government entity, it may be required to liquidate. If PNAC liquidates, its Public Stockholders may only receive \$10.20 per share, and its warrants and rights will expire worthless. This will also cause you to lose the investment opportunity in noco-noco or another target company and the chance of realizing future gains on your investment through any price appreciation in the combined company.

***Changes in laws or regulations related to business combination transactions involving SPACs may materially adversely affect PNAC’s ability to negotiate and complete an initial business combination (including the proposed Business Combination with noco-noco).***

PNAC is subject to laws and regulations enacted by national, regional, and local governments. In particular, PNAC will be required to comply with certain SEC and other legal requirements. Compliance with, and monitoring of, applicable laws and regulations may be difficult, time consuming and costly.

Those laws and regulations and their interpretation and application may also change from time to time and those changes could have a material adverse effect on PNAC's business, investments, and results of operations. In addition, a failure to comply with applicable laws or regulations, as interpreted and applied, could have a material adverse effect on PNAC's business, including PNAC's ability to negotiate and complete PNAC's initial business combination and results of operations.

On March 30, 2022, the SEC issued proposed rules relating to, among other items, enhancing disclosures in business combination transactions involving SPACs and private operating companies, amending the financial statement requirements applicable to transactions involving shell companies, enhancing disclosures regarding projections in SEC filings in connection with proposed business combination transactions, increasing the potential liability of certain participants in proposed business combination transactions, and the extent to which SPACs could become subject to regulation under the Investment Company Act of 1940. These rules, if adopted, whether in the form proposed or in a revised form, may materially adversely affect PNAC's ability to (i) complete the Business Combination with noco-noco, or (ii) if PNAC does not complete the Business Combination with noco-noco, to engage financial and capital market advisors and negotiate and complete an alternative initial business combination, and, in each case, may increase the costs and time related thereto.

***A new 1% U.S. federal excise tax could be imposed on PNAC in connection with redemptions by PNAC of its shares in connection with a business combination or other stockholder vote pursuant to which stockholders would have a right to submit their shares for redemption (a “Redemption Event”).***

On August 16, 2022, the Inflation Reduction Act of 2022 (“IR Act”) was signed into federal law. The IR Act provides for, among other things, a new U.S. federal 1% excise tax on certain repurchases (including redemptions) of stock by publicly traded domestic (i.e., U.S.) corporations and certain domestic subsidiaries of publicly traded foreign corporations.

The excise tax is imposed on the repurchasing corporation itself, not its stockholders from which shares are repurchased. The amount of the excise tax is generally 1% of the fair market value of the shares repurchased at the time of the repurchase. However, for purposes of calculating the excise tax, repurchasing corporations are permitted to net the fair market value of certain new stock issuances against the fair market value of stock repurchases during the same taxable year. In addition, certain exceptions apply to the excise tax. The U.S. Department of the Treasury (the “Treasury”) has been given authority to provide regulations and other guidance to carry out, and prevent the abuse or avoidance of the excise tax. In this regard, on December 27, 2022, the Treasury and the Internal Revenue Service issued a notice announcing their intent to issue proposed regulations addressing the application of the excise tax, and describing certain rules on which taxpayers may rely prior to the issuance of such proposed regulations (the “Notice”).

Any redemption or other repurchase that occurs after December 31, 2022 in connection with a Redemption Event may be subject to the excise tax. Pursuant to the rules set forth in the Notice, however, redemptions in connection with a liquidation of PNAC are generally not subject to the excise tax. Whether and to what extent PNAC would be subject to the excise tax in connection with a Redemption Event would depend on a number of factors, including (i) the fair market value of the redemptions and repurchases in connection with the Redemption Event, (ii) the structure of the business combination, (iii) the nature and amount of any “PIPE” or other equity issuances in connection with the business combination (or otherwise issued not in connection with the Redemption Event but issued within the same taxable year of the business combination) and (iv) the content of regulations and other future guidance from the Treasury. In addition, because the excise tax would be payable by PNAC, and not by the redeeming holder, the mechanics of any required payment of the excise tax have not been determined; however, PNAC will not use the funds held in the Trust Account or any additional amounts deposited into the Trust Account, as well as any interest earned thereon, to pay the excise tax, if any. The foregoing could cause a reduction in the cash available on hand to complete a business combination and in PNAC’s ability to complete a business combination.

#### **Risks Related to PubCo and Ownership of PubCo’s Shares**

***The Nasdaq may not list the PubCo Ordinary Shares, which could limit investors’ ability to transact in PubCo Ordinary Shares and could subject PubCo to additional trading restrictions.***

PubCo intends to apply to have the PubCo Ordinary Shares listed on the Nasdaq upon consummation of the Business Combination. PubCo will be required to meet the initial listing requirements to be listed. PubCo may not be able to meet those initial listing requirements. Even if the PubCo Ordinary Shares are so listed, it may be unable to maintain the listing of such securities in the future.

If PubCo fails to meet the initial listing requirements and the Nasdaq does not list the PubCo Ordinary Shares, and if the related closing condition is waived by the parties in order to consummate the Business Combination, thereafter PubCo could face significant material adverse consequences, including a limited availability of market quotations for the PubCo Ordinary Shares, a limited amount of news and analyst coverage on the company, and a decreased ability to issue additional PubCo Ordinary Shares or obtain additional financing in the future.

***The market price and trading volume of the PubCo Ordinary Shares may be volatile and could decline significantly following the Business Combination.***

The stock markets, including the Nasdaq on which PubCo intends to list the PubCo Ordinary Shares to be issued in the Business Combination, have from time to time experienced significant price and volume fluctuations. Even if an active, liquid and orderly trading market develops and is sustained for the PubCo Ordinary Shares following the Business Combination, the market prices of the PubCo Ordinary Shares may be volatile and could decline significantly. In addition, the trading volumes in the PubCo Ordinary Shares may fluctuate and cause significant price variations to occur. If the market prices of the PubCo Ordinary Shares decline significantly, you may be unable to resell your PubCo Ordinary Shares at or above the market price of the PubCo Ordinary Shares as of the date immediately following the consummation of the Business Combination. There can be no assurance that the market prices of the PubCo Ordinary Shares will not fluctuate widely or decline significantly in the future in response to a number of factors, including, among others, the following:

- the realization of any of the risk factors presented in this proxy statement/prospectus;
- actual or anticipated differences in our estimates, or in the estimates of analysts, for PubCo's revenues, results of operations, cash flows, level of indebtedness, liquidity or financial condition;
- announcements by PubCo or its competitors of significant business developments;
- changes in clients;
- acquisitions or expansion plans;
- PubCo's involvement in litigation;
- sale of PubCo Ordinary Shares or other securities in the future;
- market conditions in PubCo's industry;
- changes in key personnel;
- the trading volume of PubCo Ordinary Shares;
- actual, potential or perceived control, accounting or reporting problems;
- changes in accounting principles, policies and guidelines;
- other events or factors, including but not limited to those resulting from infectious diseases, health epidemics and pandemics (including but not limited to the ongoing COVID-19 pandemic), natural disasters, war, acts of terrorism or responses to these events; and
- general economic and market conditions.

In addition, the stock markets have experienced extreme price and volume fluctuations. Broad market and industry factors may materially harm the market price of the PubCo Ordinary Shares, regardless of our operating performance. In the past, following periods of volatility in the market price of a company's securities, securities class action litigation has often been instituted against that company. If PubCo were involved in any similar litigation it could incur substantial costs and our management's attention and resources could be diverted.

***We do not know whether a market will develop for the PubCo Ordinary Shares or what the market price of the PubCo Ordinary Shares will be and, as a result, it may be difficult for holders of PubCo Ordinary Shares to sell their PubCo Ordinary Shares.***

Before the offering, there was no public trading market for PubCo Ordinary Shares. Although we have applied to list the PubCo Ordinary Shares on the Nasdaq, an active trading market for the PubCo Ordinary Shares may never develop or be sustained following this offering. If a market for the PubCo Ordinary Shares does not develop or is not sustained, it may be difficult for holders of PubCo Ordinary Shares to sell their PubCo Ordinary Shares at an attractive price, if at all. This risk will be exacerbated if there is a high level of redemptions of PNAC Public Shares in connection with the closing of the Business Combination.

***PubCo will issue PubCo Ordinary Shares as consideration for the Business Combination, and PubCo may issue additional PubCo Ordinary Shares or other equity or convertible debt securities without approval of the holders of PubCo Ordinary Shares, which would dilute existing ownership interests and may depress the market price of PubCo Ordinary Shares.***

In connection with the Business Combination, PubCo is expected to issue a large amount of Ordinary Shares as consideration to be paid to the former shareholders of noco-noco and PNAC. It is anticipated that, following the Business Combination, (i) former noco-noco shareholders are expected to own approximately [·]% of the outstanding PubCo Ordinary Shares, (ii) former PNAC Public Stockholders are expected to own approximately [·]% of the outstanding PubCo Ordinary Shares, (iii) Sponsors, officers and directors and their designees are expected to own approximately [·]% of the outstanding PubCo Ordinary Shares. These percentages assume (i) closing of the Business Combination on [·], 2023 and (ii) no redemption of PNAC Class A common stock. If the actual facts differ from these assumptions, these percentages will differ.

PubCo may continue to require capital investment to support its business, and PubCo may issue additional PubCo Ordinary Shares or other equity or convertible debt securities of equal or senior rank in the future without approval of the holders of the PubCo Ordinary Shares in certain of circumstances.

PubCo's issuance of additional PubCo Ordinary Shares or other equity or convertible debt securities would have the following effects: (i) PubCo's existing shareholders' proportionate ownership interest in PubCo may decrease; (ii) the amount of cash available per share, including for payment of dividends in the future, may decrease; (iii) the relative voting power of each previously outstanding PubCo Ordinary Share may be diminished; and (iv) the market price of PubCo Ordinary Shares may decline.

Furthermore, employees, directors or consultants of PubCo and its subsidiaries and affiliates, after the Business Combination, are expected to be granted equity awards under the PubCo Incentive Plan. You will experience additional dilution when those equity awards and purchase rights become vested and settled or exercised, as applicable, for PubCo Ordinary Shares. See "*Management of PubCo Following the Business Combination—Share Incentive Plan.*"

***There will be material differences between your current rights as a holder of PNAC Public Shares and the rights one will have as a holder of PubCo Ordinary Shares, some of which may adversely affect you.***

Upon completion of the Business Combination, PNAC stockholders will no longer be stockholders of PNAC, but will be shareholders of PubCo. There will be material differences between the current rights of PNAC stockholders and the rights you will have as a holder of the PubCo Ordinary Shares, some of which may adversely affect you. For a more detailed discussion of the differences in the rights of PNAC stockholders and the PubCo shareholders, see "*Comparison of Corporate Governance and Shareholder Rights.*"

***Upon completion of the Business Combination, PNAC stockholders will become PubCo shareholders, PNAC warrant holders will become holders of PubCo Warrants and the market price for the PubCo Ordinary Shares may be affected by factors different from those that historically have affected PNAC.***

Upon completion of the Business Combination, PNAC stockholders will become PubCo shareholders and PNAC's warrant holders will become holders of PubCo Warrants, which may be exercised to acquire PubCo Ordinary Shares. PubCo's business differs from that of PNAC, and, accordingly, the results of operations of PubCo will be affected by some factors that are different from those currently affecting the results of operations of PNAC. PNAC is a special purpose acquisition company incorporated in the state of Delaware that is not engaged in any operating activity, directly or indirectly. PubCo is a holding company incorporated in the Cayman Islands and, after the consummation of the Business Combination its subsidiaries will be engaged in battery and carbon businesses in Asia-Pacific region. PubCo's business and results of operations will be affected by regional, country, and industry risks and operating risks to which PNAC was not exposed. For a discussion of the future business of PubCo currently conducted and proposed to be conducted by noco-noco, see "*noco-noco's Business*" and "*—Risks Related to noco-noco's Business and Industry.*"

***PubCo Warrants will become exercisable for PubCo Ordinary Shares 30 days after the completion of the Business Combination, which would increase the number of shares eligible for future resale in the public market and result in dilution to PNAC stockholders. Such dilution will increase if more of the PNAC Public Shares are redeemed.***

Upon the consummation of the Business Combination, pursuant to the Warrant Assumption Agreement, each PNAC Warrant outstanding immediately prior to the Merger Effective Time shall cease to be a warrant with respect to PNAC Common Stock, and shall be assumed by PubCo and converted into a warrant of PubCo to purchase one PubCo Ordinary Share, subject to substantially the same terms and conditions prior to the consummation of the Business Combination), which will become exercisable 30 days after the completion of the Business Combination. The likelihood that those PubCo Warrants will be exercised increases if the trading price of PubCo Ordinary Shares exceeds the exercise price of the PubCo Warrants. The exercise price of these warrants will be \$11.50 per share. Based on the closing price of PNAC Warrants of \$[ ] on Nasdaq on [ ], 2023, such PNAC Warrants have an aggregate market value of approximately \$[ ] million. However, there is no guarantee that the PubCo Warrants will ever be in the money after they become exercisable but prior to their expiration, and as such, the PubCo Warrants may expire worthless.



To the extent PubCo Warrants are exercised, additional shares of PubCo Ordinary Shares will be issued, which will result in dilution to the holders of PubCo Ordinary Shares and increase the number of shares eligible for resale in the public market. The dilution caused by the exercise of the PubCo Warrants will increase if a large number of PNAC Public Stockholders elect to redeem their shares in connection with the Business Combination. Holders of PNAC Warrants do not have a right to redeem the PNAC Warrants. Further, the redemption of PNAC Common Stock without any accompanying redemption of PNAC Warrants will increase the dilutive effect of the exercise of PNAC Warrants. Sales of substantial numbers of shares issued upon the exercise of PNAC Warrants in the public market or the potential that PNAC Warrants may be exercised could also adversely affect the market price of PubCo Ordinary Shares.

***Redeeming shareholders who retain PNAC Warrants will receive PubCo Warrants, the cost of which is borne by PubCo and non-redeeming shareholders. In addition, PubCo may redeem the outstanding PubCo Warrants at a price of \$0.01 per warrant.***

PNAC Stockholders holding both PNAC Class A Common Stock and PNAC Warrants may redeem their PNAC Class A Common Stock but retain the PNAC Warrants, which, if the Business Combination closes, will become PubCo Warrants. The cost of those retained warrants is borne by PubCo and the non-redeeming shareholders. In addition, once the PubCo Warrants become exercisable, PubCo may redeem the outstanding PubCo Warrants at a price of \$0.01 per warrant upon a minimum number of 30 days' prior written notice of redemption, and if the last sales price of the PubCo Ordinary Shares equals or exceeds \$16.50 per share for any 20 trading days within a 30 trading day period ending three business days before PubCo sends the notice of redemption. For context, as of the close of trading on [ ], 2023 (the most recent practicable date prior to the date of this proxy statement/prospectus), the trading price of PNAC Class A Common Stock on Nasdaq was \$[ ], and the highest and lowest closing price of the PNAC Class A Common Stock during the prior three months was \$[ ] and \$[ ], respectively. Once PubCo Warrants become exercisable after 30 days following the consummation of the Business Combination and PubCo calls for the force redemption once the conditions are met, redemption of the outstanding PubCo Warrants could force holders (i) to exercise their PubCo Warrants and pay the exercise price therefor at a time when it may be disadvantageous for them to do so, (ii) to sell PubCo Warrants at the then-current market price when they might otherwise wish to hold PubCo Warrants or (iii) to accept the nominal redemption price which, at the time the outstanding PubCo Warrants are called for redemption, is likely to be substantially less than the market value of the PubCo Warrants.

***If securities or industry analysts do not publish research, publish inaccurate or unfavorable research or cease publishing research about PubCo, its share price and trading volume could decline significantly.***

The trading market for PubCo Ordinary Shares will depend, in part, on the research and reports that securities or industry analysts publish about PubCo or its business. PubCo may be unable to sustain coverage by well-regarded securities and industry analysts. If either none or only a limited number of securities or industry analysts maintain coverage of PubCo, or if these securities or industry analysts are not widely respected within the general investment community, the demand for PubCo Ordinary Shares could decrease, which might cause its share price and trading volume to decline significantly. In the event that PubCo obtains securities or industry analyst coverage, if one or more of the analysts who cover PubCo downgrade their assessment of PubCo or publish inaccurate or unfavorable research about PubCo's business, the market price and liquidity for PubCo Ordinary Shares could be negatively impacted.

***Future resales of PubCo Ordinary Shares issued to noco-noco shareholders and other significant shareholders may cause the market price of the PubCo Ordinary Shares to drop significantly, even if PubCo's business is doing well.***

Under the Business Combination Agreement, the noco-noco shareholders will receive, among other things, [92.1]% of the outstanding PubCo Ordinary Shares, approximately [·]% of which will be eligible for sale immediately after the consummation of the Business Combination. These percentages (a) assume (i) the closing of the Business Combination on [·], 2023 and (ii) no redemption of PNAC Public Shares. If the actual facts differ from these assumptions, these percentages will differ. Pursuant to the Lock-up Agreements, certain Sellers and PNAC Initial Stockholders will be restricted, subject to certain exceptions, from selling any of the PubCo Ordinary Shares that they receive as a result of the Business Combination, which restrictions will expire upon expiration of the Lock-up Period and therefore additional PubCo Ordinary Shares will be eligible for resale as follows.

Subject to the Lock-up Agreements, certain Sellers and PNAC Initial Stockholders may sell PubCo Ordinary Shares pursuant to Rule 144 under the Securities Act, if available. In these cases, the resales must meet the criteria and conform to the requirements of that rule, including, because PNAC and PubCo are currently shell companies, waiting until one year after PubCo's filing with the SEC of a Form 20-F transition report reflecting the Business Combination. See "*Shares Eligible for Future Sale—Lock-up Agreements.*"

Upon expiration or waiver of the applicable Lock-up Period, and upon effectiveness of the registration statement PubCo files pursuant to the Registration Rights Agreement or upon satisfaction of the requirements of Rule 144 under the Securities Act, certain noco-noco shareholders and certain Sellers and PNAC Initial Stockholders may sell large amounts of PubCo Ordinary Shares in the open market or in privately negotiated transactions, which could have the effect of increasing the volatility in PubCo's share price or putting significant downward pressure on the price of the PubCo Class A Ordinary Shares. See "*Shares Eligible for Future Sale—Registration Rights*" and "*Shares Eligible for Future Sale—Rule 144.*"

***PNAC's Warrant Agreement, which is being assigned to PubCo pursuant to the Warrant Assumption Agreement upon the Closing of the Business Combination and under which one PNAC Warrant will become one PubCo Warrant upon such Closing, designates the courts of the State of New York or the United States District Court for the Southern District of New York as the sole and exclusive forum for certain types of actions and proceedings that may be initiated by holders of the warrants, which could limit the ability of warrant holders to obtain a favorable judicial forum for disputes with PubCo in connection with such warrants.***

Under the terms of the Warrant Agreement, PNAC's Warrant Agreement is being assigned by PNAC to PubCo at the Closing of the Business Combination. In connection with this assignment, each PNAC warrant will convert into a PubCo Warrant at such time and all of the terms of the Warrant Agreement not amended by the Warrant Assumption Agreement will remain in effect and applicable to each warrant holder and to PubCo after such Closing.

The Warrant Agreement provides that, subject to applicable law, (i) any action, proceeding or claim against PNAC arising out of or relating in any way to the warrant agreement will be brought and enforced in the courts of the State of New York or the United States District Court for the Southern District of New York, and (ii) that PNAC irrevocably submits to such jurisdiction, which jurisdiction shall be the exclusive forum for any such action, proceeding or claim. PNAC has waived any objection to such exclusive jurisdiction and that such courts represent an inconvenient forum. Notwithstanding the foregoing, these provisions of the Warrant Agreement will not apply to suits brought to enforce any liability or duty created by the Exchange Act or any other claim for which the federal district courts of the United States of America are the sole and exclusive forum. Any person or entity purchasing or otherwise acquiring any interest in any of PNAC's warrants shall be deemed to have notice of and to have consented to the forum provisions in the Warrant Agreement. If any action, the subject matter of which is within the scope the forum provisions of the Warrant Agreement, is filed in a court other than a court of the State of New York or the United States District Court for the Southern District of New York (a "foreign action") in the name of any holder of PNAC's warrants, such warrant holder shall be deemed to have consented to: (x) the personal jurisdiction of the state and federal courts within the State of New York or the United States District Court for the Southern District of New York in connection with any action brought in any such court to enforce the forum provisions (an "enforcement action"), and (y) having service of process made upon such warrant holder in any such enforcement action by service upon such warrant holder's counsel in the foreign action as agent for such warrant holder.

In addition, the exclusive forum provisions of the foregoing paragraph will apply to suit, action, proceeding or claim against the Company arising out of or relating and under the Securities Act. We note, however, that there is uncertainty as to whether a court would enforce such a provision and that investors cannot waive compliance with the federal securities laws and the rules and regulations thereunder. Section 22 of the Securities Act creates concurrent jurisdiction for state and federal courts over all suits brought to enforce any duty or liability created by the Securities Act or the rules and regulations thereunder.

Since the provisions of the Warrant Agreement will continue to apply unless amended by the Warrant Assumption Agreement after the Closing of the Business Combination and the conversion of each warrant from a PNAC warrant into a PubCo Warrant, and since the choice-of-forum and related provisions have not been amended by the Warrant Assumption Agreement, the choice-of-forum provision will continue to limit a warrant holder's ability after the Closing of the Business Combination to bring a claim in a judicial forum that it finds favorable for disputes with PubCo, which may discourage such lawsuits. Alternatively, if a court were to find this provision of the Warrant Agreement inapplicable or unenforceable with respect to one or more of the specified types of actions or proceedings, PubCo may incur additional costs associated with resolving such matters in other jurisdictions, which could materially and adversely affect its business, financial condition and results of operations and result in a diversion of the time and resources of PubCo's management and board of directors.

***The requirements of being a public company may strain PubCo's resources, divert PubCo management's attention and affect PubCo's ability to attract and retain qualified board members.***

PubCo will incur additional legal, accounting and other expenses following completion of the Business Combination. PubCo will be subject to the reporting requirements of the Exchange Act, the Sarbanes-Oxley Act, the Dodd-Frank Act, the Nasdaq listing requirements and other applicable securities rules and regulations. These expenses may increase even more if PubCo no longer qualifies as an "emerging growth company," as defined in Section 2(a) of the Securities Act. The Exchange Act requires, among other things, that PubCo file annual and current reports with respect to its business and operating results. The Sarbanes-Oxley Act requires, among other things, that PubCo maintains effective disclosure controls and procedures and internal control over financial reporting. PubCo may need to hire more employees post-Business Combination or engage outside consultants to comply with these requirements, which will increase its post-Business Combination costs and expenses.

Changing laws, regulations and standards relating to corporate governance and public disclosure are creating uncertainty for public companies, increasing legal and financial compliance costs and making some activities more time-consuming. These laws, regulations and standards are subject to varying interpretations, in many cases due to their lack of specificity, and, as a result, their application in practice may evolve over time as new guidance is provided by regulatory and governing bodies. This could result in continuing uncertainty regarding compliance matters and higher costs necessitated by ongoing revisions to disclosure and governance practices. PubCo expects these laws and regulations to increase its legal and financial compliance costs after the Business Combination and to render some activities more time-consuming and costly, although PubCo is currently unable to estimate these costs with any degree of certainty.

PubCo's management team has limited experience managing a publicly traded company, interacting with public company investors and complying with the increasingly complex laws pertaining to public companies. PubCo's management team may not successfully or efficiently manage the transition to being a public company subject to significant regulatory oversight and reporting obligations under the federal securities laws and regulations and the continuous scrutiny of securities analysts and investors. The need to establish the corporate infrastructure demanded of a public company may divert the management's attention from implementing its growth strategy, which could prevent PubCo from improving its business, financial condition and results of operations. Furthermore, PubCo expects these rules and regulations to make it more difficult and more expensive for PubCo to obtain director and officer liability insurance, and consequently PubCo may be required to incur substantial costs to obtain such coverage. These additional obligations could have a material adverse effect on its business, financial condition, results of operations and prospects. These factors could also make it more difficult for PubCo to attract and retain qualified members of its board of directors, particularly to serve on PubCo's audit and risk committee, remuneration committee and nominating committee, and qualified executive officers.

As a result of disclosure of information in this proxy statement/prospectus and in filings required of a public company, PubCo's business and financial condition will become more visible, which may result in threatened or actual litigation, including by competitors and other third parties. If such claims are successful, PubCo's business and operating results could be adversely affected, and, even if the claims do not result in litigation or are resolved in PubCo's favor, these claims, and the time and resources necessary to resolve them, could have an adverse effect on its business, financial condition, results of operations and prospects.

***PubCo will be an "emerging growth company" and it cannot be certain if the reduced SEC reporting requirements applicable to emerging growth companies will make PubCo's Ordinary Shares less attractive to investors, which could have a material and adverse effect on PubCo, including its growth prospects.***

Upon consummation of the Business Combination, PubCo will be an "emerging growth company" as defined in the JOBS Act. PubCo will remain an "emerging growth company" until the earliest to occur of (i) the last day of the fiscal year (a) following the fifth anniversary of the closing of the Business Combination, (b) in which PubCo has total annual gross revenue of at least \$1.235 billion or (c) in which PubCo is deemed to be a large accelerated filer, which means the market value of PubCo Ordinary Shares held by non-affiliates exceeds \$700 million as of the last business day of PubCo's prior second fiscal quarter, and (ii) the date on which PubCo issued more than \$1.0 billion in non-convertible debt during the prior three-year period. PubCo intends to take advantage of exemptions from various reporting requirements that are applicable to most other public companies, whether or not they are classified as "emerging growth companies," including, but not limited to, an exemption from the provisions of Section 404(b) of the Sarbanes-Oxley Act requiring that PubCo's independent registered public accounting firm provide an attestation report on the effectiveness of its internal control over financial reporting and reduced disclosure obligations regarding executive compensation, and exemptions from the requirements of holding a non-binding advisory vote on executive compensation and shareholder approval of any golden parachute payments not previously approved.

Furthermore, even after PubCo no longer qualifies as an “emerging growth company,” as long as PubCo continues to qualify as a foreign private issuer under the Exchange Act, PubCo will be exempt from certain provisions of the Exchange Act that are applicable to U.S. domestic public companies, including, but not limited to, the sections of the Exchange Act regulating the solicitation of proxies, consents or authorizations in respect of a security registered under the Exchange Act; the sections of the Exchange Act requiring insiders to file public reports of their stock ownership and trading activities and liability for insiders who profit from trades made in a short period of time; and the rules under the Exchange Act requiring the filing with the SEC of quarterly reports on Form 10-Q containing unaudited financial and other specified information, and current reports on Form 8-K, upon the occurrence of specified significant events. In addition, PubCo will not be required to file annual reports and financial statements with the SEC as promptly as U.S. domestic companies whose securities are registered under the Exchange Act, and are not required to comply with Regulation FD, which restricts the selective disclosure of material information. See “—Risks Related to PubCo and Ownership of PubCo’s Shares—PubCo is a company incorporated in the Cayman Islands and will qualify as a foreign private issuer within the meaning of the rules under the Exchange Act, and as such PubCo is exempt from certain provisions applicable to United States domestic public companies.”

As a result, PubCo shareholders may not have access to certain information they deem important. PubCo cannot predict if investors will find PubCo Ordinary Shares less attractive because it relies on these exemptions. If some investors do find PubCo Ordinary Shares less attractive as a result, there may be a less active trading market and share price for PubCo Ordinary Shares may be more volatile.

***PubCo is a company incorporated in the Cayman Islands and will qualify as a foreign private issuer within the meaning of the rules under the Exchange Act, and as such PubCo is exempt from certain provisions applicable to United States domestic public companies.***

PubCo is a foreign private issuer as such term is defined in Rule 405 under the Securities Act and is a company incorporated in the Cayman Islands, and, after the consummation of the Business Combination, will be listed on the Nasdaq. The Nasdaq market rules permit a foreign private issuer like PubCo to follow the corporate governance practices of its home country. Certain corporate governance practices in the Cayman Islands, which is PubCo’s home country, may differ significantly from the Nasdaq corporate governance listing standards applicable to domestic U.S. companies.

Because PubCo will qualify as a foreign private issuer under the Exchange Act immediately following the consummation of the Business Combination, PubCo is exempt from certain provisions of the securities rules and regulations in the United States that are applicable to U.S. domestic issuers, including: (i) the rules under the Exchange Act requiring the filing of quarterly reports on Form 10-Q and current reports on Form 8-K with the SEC; (ii) the sections of the Exchange Act regulating the solicitation of proxies, consents, or authorizations in respect of a security registered under the Exchange Act; (iii) the sections of the Exchange Act requiring insiders to file public reports of their share ownership and trading activities and liability for insiders who profit from trades made in a short period of time; and (iv) the selective disclosure rules by issuers of material nonpublic information under Regulation FD.

In addition, PubCo is not required to have: (i) a majority of the board of directors consist of independent directors; (ii) a compensation committee consisting of independent directors; (iii) a nominating and corporate committee consisting of independent directors; or (iv) regularly scheduled executive sessions with only independent directors each year.

PubCo intends to rely on some of the exemptions listed above. As a result, you may not be provided with the benefits of certain corporate governance requirements of the Nasdaq applicable to U.S. domestic public companies.

PubCo will be required to file an annual report on Form 20-F within four months of the end of each fiscal year. Press releases relating to financial results and material events will also be furnished to the SEC on Form 6-K. However, the information PubCo is required to file with or furnish to the SEC will be less extensive and less timely compared to that required to be filed with the SEC by U.S. domestic issuers. Accordingly, after the Business Combination, if you continue to hold PubCo Ordinary Shares, you may receive less or different information about PubCo than you currently receive about Bridgetown 2 or that you would receive about a U.S. domestic public company.

The determination of foreign private issuer status is made annually on the last business day of an issuer's most recently completed second fiscal quarter and, accordingly, the next determination will be made with respect to PubCo on June 30, 2023.

In the future, PubCo could lose its status as a foreign private issuer under current SEC rules and regulations if more than 50% of PubCo's outstanding voting securities become directly or indirectly held of record by U.S. holders and any one of the following is true: (i) the majority of PubCo's directors or executive officers are U.S. citizens or residents; (ii) more than 50% of PubCo's assets are located in the United States; or (iii) PubCo's business is administered principally in the United States. If PubCo loses its status as a foreign private issuer in the future, it will no longer be exempt from the rules described above and, among other things, will be required to file periodic reports and annual and quarterly financial statements as if it were a company incorporated in the United States. If this were to happen, PubCo would likely incur substantial costs in fulfilling these additional regulatory requirements, including costs related to the preparation of financial statements in accordance with U.S. GAAP, and members of PubCo's management would likely have to divert time and resources from other responsibilities to ensuring these additional regulatory requirements are fulfilled.

***Because we are a "controlled company" as defined in the Nasdaq Stock Market Rules, you may not have protections of certain corporate governance requirements which otherwise are required by Nasdaq's rules.***

Under Nasdaq's rules, a controlled company is a company of which more than 50% of the voting power for the election of directors is held by an individual, group or another company. We are a controlled company because 3DOM Alliance, our parent company, holds more than 50% of our voting power, and we expect we will continue to be a controlled company upon completion of this offering. For so long as we remain a controlled company, we are not required to comply with the following permitted to elect to rely, and may rely, on certain exemptions from the obligation to comply with certain corporate governance requirements, including:

- our board of directors is not required to be comprised of a majority of independent directors.
- our board of directors is not subject to the compensation committee requirement; and
- we are not subject to the requirements that director nominees be selected either by the independent directors or a nomination committee comprised solely of independent directors.

As a result, if we take advantage of these exemptions, you will not have the same protections afforded to shareholders of companies that are subject to all of the Nasdaq corporate governance requirements. We intend to take advantage some of these controlled company exemptions. As a result, you may not be provided with the benefits of certain corporate governance requirements of Nasdaq applicable to U.S. domestic public companies.

***You may face difficulties in protecting your interests, and certain judgement obtained against our directors and officers may not be enforceable.***

PubCo is an exempted company limited by shares incorporated under the laws of the Cayman Islands, and following the Business Combination, will conduct a majority of its operations through its subsidiary, noco-noco, outside the United States. Substantially all of PubCo's assets are located outside the United States. All of PubCo's current officers and directors are nationals and residents of countries other than the United States and a substantial portion of the assets of those persons are located outside of the United States. As a result, it could be difficult or impossible for you to bring an action against PubCo or against these individuals outside of the United States in the event that you believe that your rights have been infringed upon under the applicable securities laws or otherwise and it will be difficult to effect service of process within the United States upon PubCo's officers or directors, or enforce judgments obtained in United States courts against PubCo's officers or directors. Even if you are successful in bringing an action of this kind, the laws of the Cayman Islands and of the jurisdictions that comprise the Asian region could render you unable to enforce a judgment against PubCo's assets or the assets of PubCo's directors and officers. In addition, it is unclear if any applicable extradition treaties now in effect between the United States and Asia markets would permit effective enforcement of criminal penalties of U.S. federal securities laws.

In addition, PubCo's corporate affairs will be governed by the Amended PubCo Charter, the Cayman Islands Companies Act and the common law of the Cayman Islands. The rights of shareholders to take action against the directors, actions by minority shareholders and the fiduciary duties of PubCo's directors to PubCo under Cayman Islands law are to a large extent governed by the common law of the Cayman Islands. The common law of the Cayman Islands is derived in part from comparatively limited judicial precedent in the Cayman Islands as well as from the common law of England and Wales, the decisions of whose courts are of persuasive authority, but are not binding, on a court in the Cayman Islands. The rights of PubCo's shareholders and the fiduciary duties of PubCo's directors under Cayman Islands law may not be as clearly established as they would be under statutes or judicial precedent in some jurisdictions in the United States. In particular, the Cayman Islands has a different body of securities laws than the United States. Some U.S. states, such as Delaware, may have more fully developed and judicially interpreted bodies of corporate law than the Cayman Islands. In addition, Cayman Islands companies may not have standing to initiate a shareholder derivative action in a federal court of the United States.

Shareholders of Cayman Islands exempted companies like PubCo have no general rights under Cayman Islands law to inspect corporate records (other than the memorandum and articles of association, any special resolutions passed by such companies and the register of mortgages and charges of such companies) or to obtain copies of lists of shareholders of these companies. PubCo's directors will have discretion under the Amended PubCo Charter to determine whether or not, and under what conditions, PubCo's corporate records may be inspected by its shareholders, but PubCo is not obliged to make them available to the shareholders (subject to limited circumstances in which an inspector may be appointed to report on the affairs of PubCo). This may make it more difficult for you to obtain the information needed to establish any facts necessary for a shareholder motion or to solicit proxies from other shareholders in connection with a proxy contest. See *"Description of PubCo Securities—Inspection of Books and Records."*

The courts of the Cayman Islands are unlikely (i) to recognize or enforce judgments of courts of the United States predicated upon the civil liability provisions of the federal securities laws of the United States or any state securities laws; and (ii) in original actions brought in the Cayman Islands, to impose liabilities predicated upon the civil liability provisions of the federal securities laws of the United States or any state securities laws, so far as the liabilities imposed by those provisions are penal in nature. In those circumstances, although there is no statutory enforcement in the Cayman Islands of judgments obtained in the United States, the courts of the Cayman Islands will recognize and enforce a foreign money judgment of a foreign court of competent jurisdiction without retrial on the merits based on the principle that a judgment of a competent foreign court imposes upon the judgment debtor an obligation to pay the sum for which judgment has been given provided certain conditions are met. For a foreign judgment to be enforced in the Cayman Islands, such judgment must be final and conclusive and for a liquidated sum, and must not be in respect of taxes or a fine or penalty, inconsistent with a Cayman Islands judgment in respect of the same matter, impeachable on the grounds of fraud or obtained in a manner, or be of a kind the enforcement of which is, contrary to natural justice or the public policy of the Cayman Islands (awards of punitive or multiple damages may well be held to be contrary to public policy). A Cayman Islands court may stay enforcement proceedings if concurrent proceedings are being brought elsewhere.

***PubCo is permitted to adopt certain home country practices in relation to corporate governance matters that differ significantly from the Nasdaq listing standards. These practices may afford less protection to shareholders than they would enjoy if we complied fully with corporate governance listing standards.***

Certain corporate governance practices in the Cayman Islands, which is PubCo's home country, differ significantly from corporate governance listing standards as, except for general fiduciary duties and duties of care, Cayman Islands law has no corporate governance regime which prescribes specific corporate governance standards. To the extent PubCo chooses to follow home country practice with respect to corporate governance matters, its shareholders may be afforded less protection than they otherwise would have under corporate governance listing standards applicable to U.S. domestic issuers.

As a result of all of the above, PubCo's shareholders may have more difficulty in protecting their interests in the face of actions taken by management, members of the board of directors or controlling shareholders than they would as public shareholders of a company incorporated in the United States.

***The ability of PubCo’s operating subsidiaries after the consummation of the Business Combination in certain Asia markets to distribute dividends to PubCo may be subject to restrictions under their respective laws.***

PubCo is a holding company, and its operating subsidiaries after the consummation of the Business Combination may be located in Singapore, Thailand, the Philippines, Indonesia, India, Australia, or PNG. Part of PubCo’s primary internal sources of funds to meet its cash needs will be its share of the dividends, if any, paid by PubCo’s operating subsidiaries. The distribution of dividends to PubCo from the operating subsidiaries in these markets as well as other markets where PubCo may operate is subject to restrictions imposed by the applicable laws and regulations in these markets.

***It is not expected that PubCo will pay dividends in the foreseeable future after the Business Combination.***

It is expected that PubCo will retain most, if not all, of its available funds and any future earnings after the Business Combination to fund the development and growth of its business. As a result, it is not expected that PubCo will pay any cash dividends in the foreseeable future.

Following completion of the Business Combination, PubCo’s board of directors will have complete discretion as to whether to distribute dividends, subject to certain requirements of Cayman Islands law. In addition, our shareholders may by ordinary resolution declare a dividend, but no dividend may exceed the amount recommended by our directors. Under Cayman Islands law, a Cayman Islands company may pay a dividend out of either profit or share premium account, provided that in no circumstances may a dividend be paid if this would result in the company being unable to pay its debts as they fall due in the ordinary course of business. Even if the board of directors decides to declare and pay dividends, the timing, amount and form of future dividends, if any, will depend on the future results of operations and cash flow, capital requirements and surplus, the amount of distributions, if any, received by PubCo from its operating subsidiaries, PubCo’s financial condition, contractual restrictions and other factors deemed relevant by the board of directors. There is no guarantee that the shares of PubCo will appreciate in value after the Business Combination or that the trading price of the shares will not decline. Holders of the PubCo Ordinary Shares should not rely on an investment in PubCo Ordinary Shares as a source for any future dividend income. You may not realize a return on your investment in PubCo Ordinary Shares and you may even lose your entire investment in our ordinary shares.

***Cayman Islands economic substance requirements may have an effect on our business and operations.***

Pursuant to the International Tax Cooperation (Economic Substance) Act, 2018 of the Cayman Islands, or the ES Act, that came into force on January 1, 2019, a “relevant entity” is required to satisfy the economic substance test set out in the ES Act. A “relevant entity” includes an exempted company incorporated in the Cayman Islands as is PubCo. Based on the current interpretation of the ES Act, we believe that PubCo is a pure equity holding company since it only holds equity participation in other entities and only earns dividends and capital gains. Accordingly, for so long as PubCo is a “pure equity holding company”, it is only subject to the minimum substance requirements, which require us to (i) comply with all applicable filing requirements under the Cayman Islands Companies Act; and (ii) has adequate human resources and adequate premises in the Cayman Islands for holding and managing equity participations in other entities. However, there can be no assurance that PubCo will not be subject to more requirements under the ES Act. Uncertainties over the interpretation and implementation of the ES Act may have an adverse impact on the business and operations of PubCo.

***PubCo will grant in the future, share incentives, which may result in increased share-based compensation expenses.***

In [●] 2023, in connection with the Business Combination, PubCo’s board of directors adopted and PubCo’s shareholders approved the noco-noco Inc. 2023 Equity Incentive Plan, or the PubCo Incentive Plan. Initially, the maximum number of PubCo Ordinary Shares that may be issued under the PubCo Incentive Plan after it becomes effective will be five percent (5%) of the fully diluted share capital of PubCo that are outstanding upon consummation of the Business Combination. The PubCo Incentive Plan permits the awards of dividend equivalents, options, restricted shares, restricted share units, share appreciation rights or other rights or benefits to employees, directors and consultants of PubCo and its subsidiaries and affiliates. For more information on the share incentive plan, see “*Management of PubCo Following the Business Combination—Share Incentive Plan.*” PubCo believes the granting of share-based compensation is of significant importance to its ability to attract and retain key personnel and employees, and will do so after the consummation of the Business Combination. As a result, expenses associated with share-based compensation may increase, which may have an adverse effect on PubCo’s business and results of operations.

***If PubCo Ordinary Shares are not eligible for deposit and clearing within the facilities of the Depository Trust Company, then transactions in the PubCo Ordinary Shares may be disrupted.***

The facilities of DTC are a widely used mechanism that allow for rapid electronic transfers of securities between the participants in the DTC system, which include many large banks and brokerage firms. PubCo expects that PubCo Ordinary Shares will be eligible for deposit and clearing within the DTC system. DTC is not obligated to accept PubCo Ordinary Shares for deposit and clearing within its facilities in connection with the listing and, even if DTC does initially accept PubCo Ordinary Shares, it will generally have discretion to cease to act as a depository and clearing agency for PubCo Ordinary Shares.

If DTC determines prior to the completion of the transactions that PubCo Ordinary Shares are not eligible for clearance within the DTC system, then PubCo would not expect to complete the transactions and the listing contemplated by this proxy statement/prospectus in its current form. However, if DTC determines at any time after the completion of the transactions and the listing that PubCo Ordinary Shares were not eligible for continued deposit and clearance within its facilities, then PubCo believes PubCo Ordinary Shares would not be eligible for continued listing on a U.S. securities exchange and trading in the shares would be disrupted. While PubCo would pursue alternative arrangements to preserve its listing and maintain trading, any such disruption could have a material adverse effect on the market price of PubCo Ordinary Shares.

#### **Risks Related to Taxation**

***The Merger may be a taxable event for U.S. Holders of PNAC Common Stock and PNAC Warrants.***

Subject to the limitations and qualifications described in “United States Federal Income Tax Considerations—U.S. Federal Income Tax Consequences of the Business Combination to U.S. Holders,” the Merger should qualify as a “reorganization” within the meaning of Section 368 of the Code and, as a result, a U.S. Holder (as defined in “United States Federal Income Tax Considerations—U.S. Federal Income Tax Consequences of the Business Combination to U.S. Holders”) should not recognize gain or loss on the exchange of PNAC securities for PubCo Ordinary Shares, as applicable, pursuant to the Business Combination. However, if the Merger does not qualify as a reorganization within the meaning of Section 368 of the Code for any reason, a U.S. Holder that exchanges its PNAC securities for the consideration under the Business Combination will recognize gain or loss equal to the difference between (i) the sum of the fair market value of the PubCo Ordinary Shares received and (ii) the U.S. Holder’s adjusted tax basis in the PNAC securities exchanged.

***PubCo may be or become a passive foreign investment company (“PFIC”), which could result in adverse U.S. federal income tax consequences to U.S. Holders.***

If PubCo [(or its predecessor PNAC)] is a PFIC for any taxable year, or portion thereof, that is included in the holding period of a beneficial owner of the PubCo Ordinary Shares that is a U.S. Holder, such U.S. Holder may be subject to certain adverse U.S. federal income tax consequences and may be subject to additional reporting requirements. [Following the [Merger], assuming that the [Merger] qualifies as an “F” reorganization within the meaning of Section 368(a)(1)(F) of the Code, and/or as a “forward triangular merger” within the meaning of Section 368(a)(2)(D), PubCo will be treated as the successor to PNAC for U.S. federal income tax purposes, and for the taxable year that includes the Business Combination and subsequent taxable years, the PFIC asset and income tests will be applied based on the assets and activities of the combined business.



Based on the anticipated timing of the Business Combination, the anticipated assets and income of PubCo and the application of the start-up exception, [PNAC or its successor] PubCo (as the case may be) are not currently expected to be treated as a PFIC for the current taxable year ending on December 31, 20[●] or the foreseeable future. However, the facts on which any determination of PFIC status are based may not be known until the close of each taxable year in question, and, in the case of the current taxable year, until as late as the close of two subsequent taxable years. Additionally, there is uncertainty regarding the application of the start-up exception.

See “*Material Tax Considerations—United States Federal Income Tax Considerations—PFIC Considerations*” for a more detailed discussion with respect to PubCo’s PFIC status. U.S. Holders are urged to consult their tax advisors regarding the possible application of the PFIC rules to holders of the PubCo Ordinary Shares.]

## SPECIAL MEETING OF PNAC STOCKHOLDERS

### General

PNAC is furnishing this proxy statement/prospectus to PNAC stockholders as part of the solicitation of proxies by PNAC's board of directors for use at the Special Meeting of PNAC stockholders to be held on \_\_\_\_\_, 2023, and at any adjournment or postponement thereof. This proxy statement/prospectus is first being furnished to PNAC stockholders on or about \_\_\_\_\_, 2023 in connection with the vote on the proposals described in this proxy statement/prospectus. This proxy statement/prospectus provides PNAC stockholders with information they need to know to be able to vote or instruct their vote to be cast at the Special Meeting.

### Date, Time and Place

The Special Meeting of shareholders shall be held on \_\_\_\_\_, 2023 at \_\_\_\_\_ AM, Eastern time. The Special Meeting shall be held virtually via live webcast at \_\_\_\_\_. Should PNAC stockholders attend the Special Meeting virtually, each may vote and submit questions during the Special Meeting by visiting [ ] and entering their control number. We are pleased to utilize virtual shareholder meeting technology to (i) provide ready access and cost savings for PNAC stockholders and PNAC, and (ii) to promote social distancing pursuant to guidance provided by the CDC and the SEC due to COVID-19. The virtual meeting format allows attendance from any location in the world.

### Purpose of PNAC Special Meeting

At the Special Meeting, PNAC is asking holders of PNAC Common Stock to:

- consider and vote upon the Business Combination Proposal;
- consider and vote upon the Governing Documents Proposal; and
- if presented, consider and vote upon the Adjournment Proposal.

Under the Business Combination Agreement, the approval of the Business Combination Proposal and the Governing Documents Proposal by the requisite vote of PNAC stockholders is a condition to the consummation of the Business Combination.

### Recommendation of PNAC Board of Directors FOR the Business Combination, the Governing Documents Proposal and the Adjournment Proposal

PNAC's board of directors has unanimously determined that the Business Combination Proposal, and the Governing Documents Proposal are fair to and in the best interests of PNAC; has unanimously approved the Business Combination Proposal, and the Governing Documents Proposal; unanimously recommends that shareholders vote "FOR" the Business Combination Proposal and "FOR" the Governing Documents Proposal; and unanimously recommends that shareholders vote "FOR" the Adjournment Proposal if it is presented to the meeting.

The existence of financial and personal interests of one or more of PNAC's directors results in conflicts of interest on the part of such director(s) between what he, she or they may believe is in the best interests of PNAC and its shareholders and what he, she or they may believe is best for himself, herself or themselves in determining to recommend that shareholders vote for the proposals. In addition, PNAC's officers have interests in the Business Combination that may conflict with your interests as a shareholder. See the section entitled "*The Business Combination Proposal—Interests of PNAC's Directors and Executive Officers in the Business Combination*" for a further discussion of these considerations.

### Record Date; Outstanding Shares; Shareholders Entitled to Vote

PNAC has fixed the close of business on \_\_\_\_\_, 2023, as the "Record Date" for determining PNAC stockholders entitled to notice of and to attend and vote at the Special Meeting. If your shares are held in "street name" or are in a margin or similar account, you should contact your broker to ensure that votes related to the shares you beneficially own are properly counted. PNAC Units, PNAC Warrants and PNAC Rights do not have voting rights. As of the close of business on the Record Date, there were 6,923,691 shares of PNAC Class A Common Stock and no shares of PNAC Class B Common Stock outstanding and entitled to vote. Each PNAC Common Stock is entitled to one vote per share at the Special Meeting.

## Quorum

The presence, by means of remote communication or by proxy, of the holders of a majority of all the issued and outstanding PNAC Common Stock entitled to vote at the Special Meeting constitutes a quorum at the Special Meeting. As of the Record Date for the Special Meeting, 3,461,846 PNAC Common Stock would be required to achieve a quorum.

## Abstentions and Broker Non-Votes

Proxies that are marked “abstain” and proxies relating to “street name” shares that are returned to PNAC but marked by brokers as “not voted” will be treated as shares present for purposes of determining the presence of a quorum on all matters, but they will not be treated as shares voted on the matter. Under the rules of various national and regional securities exchanges, your broker, bank, or nominee cannot vote your shares with respect to non-discretionary matters unless you provide instructions on how to vote in accordance with the information and procedures provided to you by your broker, bank, or nominee. We believe all the proposals presented to the shareholders will be considered non-discretionary and therefore your broker, bank, or nominee cannot vote your shares without your instruction.

## Vote Required

The approval of each of Business Combination Proposal and the Governing Documents Proposal requires the affirmative vote of the holders of a majority of the shares of PNAC Common Stock in respect of the relevant proposal and entitled to vote thereon at the Special Meeting. The Adjournment Proposal is not conditioned upon the approval of any other proposal set forth in this proxy statement/prospectus.

The approval of the Adjournment Proposal if presented will require the consent of the meeting, which means a simple majority of the votes which are cast by those shareholders of PNAC who are present, in person or by proxy, and vote thereupon at the Special Meeting.

## Voting Your Shares

Each share of PNAC Common Stock that you own in your name entitles you to one vote. Your proxy card shows the number of shares of PNAC Common Stock that you own. If your shares are held in “street name” or are in a margin or similar account, you should contact your broker to ensure that votes related to the shares you beneficially own are properly counted.

There are two ways to vote your shares of PNAC Common Stock at the Special Meeting:

- You can vote by signing and returning the enclosed proxy card. If you vote by proxy card, your “proxy,” whose name is listed on the proxy card, will vote your shares as you instruct on the proxy card. If you sign and return the proxy card but do not give instructions on how to vote your shares, your shares will be voted as recommended by the PNAC Board “FOR” the Business Combination Proposal, “FOR” the Governing Documents Proposal and “FOR” the Adjournment Proposal, in each case, if presented to the Special Meeting. Votes received after a matter has been voted upon at the Special Meeting will not be counted; or
- You can attend the Special Meeting virtually and vote electronically.

Beneficial shareholders who wish to attend the Special Meeting must obtain a legal proxy by contacting their account representative at the bank, broker, or other nominee that holds their shares and e-mailing a copy (a legible photograph is sufficient) of their legal proxy to . Beneficial shareholders who email a valid legal proxy shall be issued a meeting control number that shall allow them to register to attend and participate in the Special Meeting. After contacting our transfer agent, a beneficial holder shall receive an email prior to the meeting with a link and instructions for entering the Special Meeting. Beneficial shareholders should contact our transfer agent at least five business days prior to the meeting date.

## Revoking Your Proxy

If you are a shareholder and you give a proxy, you may revoke it at any time before it is exercised by doing any one of the following:

- you may send another proxy card with a later date; or
- you may notify PNAC, in writing, before the Special Meeting that you have revoked your proxy (if you do so, you may attend the Special Meeting virtually and vote via electronic communication, as indicated above).

## Who Can Answer Your Questions About Voting Your Shares

If you are a PNAC stockholder and have any questions about how to vote or direct a vote in respect of your shares of PNAC Common Stock, you may call \_\_\_\_\_, PNAC's proxy solicitor, at \_\_\_\_\_, or banks and brokers can call \_\_\_\_\_, or by email at \_\_\_\_\_.

## Redemption Rights

PNAC Public Stockholders may seek to have their shares redeemed for cash, regardless of whether they vote or, if they do vote, irrespective of whether they vote for or against the Business Combination Proposal or the Governing Documents Proposal. Any PNAC Public Stockholder may demand that PNAC redeem such shares for a per-share price, payable in cash, equal to the pro rata portion of the amount on deposit in the Trust Account (which was \$ \_\_\_\_\_ per share as of \_\_\_\_\_, 2022, the Record Date), calculated as of two business days prior to the anticipated consummation of the Business Combination, including interest earned on the funds held in the Trust Account and not previously released to PNAC. If a PNAC Public Stockholder properly seeks redemption as described in this section and the Business Combination is consummated, PNAC shall redeem these shares for a pro rata portion of funds deposited in the Trust Account and the holder shall no longer own these shares. A PNAC Public Stockholder, together with any affiliate of such holder and any person with whom such holder is acting in concert or as a "group" (as defined under Section 13(d) (3) of the Exchange Act) may not seek to have more than 15% of the aggregate PNAC Public Shares redeemed without the consent of PNAC.

The PNAC Initial Stockholders shall not have redemption rights with respect to any PNAC Common Stock owned by them, directly or indirectly.

PNAC Public Stockholders who seek to have their PNAC Public Shares redeemed are required to (A) submit a redemption request in writing to VStock, PNAC's transfer agent, in which (i) they request that PNAC redeems all or a portion of their PNAC Public Shares for cash and (ii) identify themselves as the beneficial holders of the shares and provide their legal name, phone number and address, and (B) deliver their PNAC Public Shares, either physically or electronically using DTC's DWAC System, to PNAC's transfer agent no later than \_\_\_\_\_ p.m. \_\_\_\_\_ time on \_\_\_\_\_, 2023 (two business days prior to the Special Meeting). If you hold the shares in street name, you shall have to coordinate with your broker to have your shares certificated or delivered electronically. Certificates that have not been tendered (either physically or electronically) in accordance with these procedures shall not be converted into cash. There is a nominal cost associated with this tendering process and the act of certificating the shares or delivering them through the DWAC system. The transfer agent shall typically charge the tendering broker \$100.00 and it would be up to the broker whether or not to pass this cost on to the converting shareholder. In the event the proposed Business Combination is not consummated, this may result in an additional cost to shareholders for the return of their shares.

Any request to have PNAC Public Shares redeemed, once made by a PNAC Public Stockholder, may be withdrawn at any time up to the vote on the Business Combination Proposal and the Governing Documents Proposal, but only with the consent of the Board of Directors of PNAC. If a PNAC Public Stockholder delivers its PNAC Public Shares for redemption and later decides prior to the Special Meeting not to elect redemption, such holder may request that PNAC consent to the return of such shares to such holder. Such a request must be made by contacting VStock, PNAC's transfer agent, at the phone number or address set out elsewhere in this proxy statement/prospectus.

If the Business Combination is not approved or completed for any reason, then PNAC Public Stockholders who elected to exercise their redemption rights shall not be entitled to have their PNAC Public Shares redeemed for or upon electing to redeem their PNAC Public Shares in connection with a subsequent initial business combination which is consummated. PNAC shall thereafter promptly return any shares delivered by PNAC Public Stockholders. In such case, PNAC Public Stockholders may only share in the assets of the Trust Account upon the liquidation of PNAC. This may result in PNAC Public Stockholders receiving less than they would have received if the Business Combination was completed and they had exercised redemption rights in connection therewith due to potential claims of creditors.

The closing price of PNAC Class A Common Stock on the Record Date was \$ . The cash held in the Trust Account on such date was approximately \$ million (approximately \$ per share). Prior to exercising redemption rights, PNAC Public Stockholders should verify the market price of PNAC Common Stock as they may receive higher proceeds from the sale of their shares of PNAC Common Stock in the public market than from exercising their redemption rights if the market price per share is higher than the redemption price. PNAC cannot assure its stockholders that they shall be able to sell their PNAC Public Shares in the open market, even if the market price per share is higher than the redemption price stated above, as there may not be sufficient liquidity in its securities when its stockholders wish to sell their shares.

PNAC shareholders holding both PNAC Class A Common Stock and PNAC Warrants may redeem their PNAC Class A Common Stock but retain the PNAC Warrants, which, if the Business Combination closes, will become PubCo Warrants. The cost of those retained warrants is borne by PubCo and the non-redeeming shareholders. Assuming that 100% of the PNAC Public Shares held by PNAC Public Stockholders were to be redeemed, the [ ] retained outstanding PNAC Warrants, which will be automatically and irrevocably assigned to, and assumed by, PubCo following the Closing of the Business Combination, would have an aggregate value of \$[ ] million, based on a price per PNAC Warrants of \$[ ] on [ ], 2023, the most recent practicable date prior to the date of this proxy statement/prospectus. In addition, on [ ], 2023, the most recent practicable date prior to the date of this proxy statement/prospectus, the price per share of PNAC Class A Common Stock closed at \$[ ]. If PNAC Class A Common Stock are trading above the exercise price of \$11.50 per warrant, the PubCo Warrants are considered to be “in the money” and are therefore more likely to be exercised by the holders thereof (when they become exercisable 30 days following the Closing of the Business Combination) and this in turn increases the risk to non-redeeming shareholders that the PubCo Warrants will be exercised, which would result in immediate dilution to the non-redeeming shareholders.

In addition, once the PubCo Warrants become exercisable, PubCo may redeem the outstanding PubCo Warrants at a price of \$0.01 per warrant upon a minimum number of 30 days’ prior written notice of redemption, and if the last sales price of the PubCo Ordinary Shares equals or exceeds \$16.50 per share for any 20 trading days within a 30 trading day period ending three business days before PubCo sends the notice of redemption. For context, as of the close of trading on [ ], 2023 (the most recent practicable date prior to the date of this proxy statement/prospectus), the trading price of KACL Ordinary Share on Nasdaq was \$[ ], and the highest and lowest closing price of the KACL Ordinary Shares during the prior three months was \$[ ] and \$[ ], respectively. Once PubCo Warrants become exercisable after 30 days following the consummation of the Business Combination and PubCo calls for the force redemption once the conditions are met, redemption of the outstanding PubCo Warrants could force holders (i) to exercise their PubCo Warrants and pay the exercise price therefor at a time when it may be disadvantageous for them to do so, (ii) to sell PubCo Warrants at the then-current market price when they might otherwise wish to hold PubCo Warrants or (iii) to accept the nominal redemption price which, at the time the outstanding PubCo Warrants are called for redemption, is likely to be substantially less than the market value of the PubCo Warrants.

#### **No Appraisal or Dissenters’ Rights**

No holders who hold PNAC units, PNAC Common Stock, PNAC Warrants or PNAC Rights have appraisal or dissenters’ rights in connection with the Business Combination under the DGCL. Therefore, no dissenters’ rights will be available under the Merger in respect of the PNAC securities; however, PNAC Public Stockholders have a redemption right with respect to their PNAC Public Shares as further described in this proxy statement/prospectus. See “*Special Meeting of PNAC stockholders—Redemption Rights*” for a detailed description of the procedures to be followed if you wish to redeem your PNAC Public Shares for cash.

#### **Proxy Solicitation Costs**

PNAC is soliciting proxies on behalf of its board of directors. This solicitation is being made by mail but also may be made by telephone or in person. PNAC and its directors, officers and employees may also solicit proxies in person by telephone or by other electronic means. PNAC shall bear the cost of the solicitation.

PNAC has hired [proxy agent] to assist in the proxy solicitation process. PNAC shall pay [proxy agent] a fixed fee of \$ , plus disbursements, and shall pay \$ for each holder’s proxy solicited by [proxy agent] , and shall reimburse [proxy agent] for its reasonable and documented costs and expenses and shall indemnify [proxy agent] and its affiliates against certain claims, liabilities, losses, damages and expenses. Such fee shall be paid with non-Trust Account funds. PNAC shall pay the cost of soliciting proxies for the Special Meeting.

PNAC shall ask banks, brokers and other institutions, nominees and fiduciaries to forward the proxy materials to their principals and to obtain their authority to execute proxies and voting instructions, and shall reimburse such parties for their expenses in forwarding soliciting materials to beneficial owners of PNAC Common Stock and in obtaining voting instructions from those owners.

PNAC’s directors and officers may also solicit proxies by telephone, by facsimile, by mail, on the Internet or in person. They will not be paid any additional amounts for soliciting proxies.

## THE BUSINESS COMBINATION PROPOSAL

### General

PNAC stockholders are being asked to (a) adopt and approve the Business Combination Agreement and other Transaction Documents (as defined in the Business Combination Agreement), (b) approve the Business Combination which includes (i) the Merger between PNAC and Merger Sub with PNAC surviving the Merger and becoming a wholly owned subsidiary of PubCo, (ii) the Share Exchange whereby the Sellers will exchange their noco-noco Shares for newly issued PubCo Ordinary Shares and noco-noco will be an indirect subsidiary of PubCo, and (iii) other transactions contemplated therein.

PNAC stockholders should read carefully this proxy statement/prospectus in its entirety for more detailed information concerning the Business Combination Agreement, which is attached as Annex A to this proxy statement/prospectus. Please see the section entitled “—*The Business Combination Agreement*” below, for additional information and a summary of certain terms of the Business Combination Agreement. You are urged to read carefully the Business Combination Agreement in its entirety before voting on this proposal.

Under the Business Combination Agreement, the approval of the Business Combination Proposal and the Governing Documents Proposal by the requisite vote of PNAC stockholders is a condition to the consummation of the Business Combination. The approval of each of Business Combination Proposal and the Governing Documents Proposal requires the affirmative vote of the holders of a majority of the shares of PNAC Common Stock in respect of the relevant proposal and entitled to vote thereon at the Special Meeting. The Adjournment Proposal is not conditioned upon the approval of any other proposal set forth in this proxy statement/prospectus.

### The Business Combination Agreement

On December 29, 2022, PNAC, PubCo, Merger Sub, New SubCo, the Sellers and noco-noco entered into the Business Combination Agreement. The subsections that follow this subsection describe the material provisions of the Business Combination Agreement, but do not purport to describe all of the terms of the Business Combination Agreement. The following summary is qualified in its entirety by reference to the complete text of the Business Combination Agreement, a copy of which is attached as Annex A hereto. PNAC stockholders and other interested parties are urged to read the Business Combination Agreement carefully and, in its entirety, (and, if appropriate, with the advice of financial and legal counsel) because it is the primary legal document that governs the Business Combination.

The Business Combination Agreement contains representations, warranties and covenants that the respective parties made to each other as of the date of the Business Combination Agreement or other specific dates. The assertions embodied in those representations, warranties and covenants were made for purposes of the contract among the respective parties and are subject to important qualifications and limitations agreed to by the parties in connection with negotiating the Business Combination Agreement. The representations, warranties and covenants in the Business Combination Agreement are also modified in important part by the disclosure letters referred to therein which are not filed publicly and which are subject to a contractual standard of materiality different from that generally applicable to shareholders. The disclosure letters were used for the purpose of allocating risk among the parties rather than establishing matters as facts. We do not believe that the disclosure letters contain information that is material to an investment decision. Moreover, certain representations and warranties in the Business Combination Agreement may, may not have been or may not be, as applicable, accurate as of any specific date and do not purport to be accurate as of the date of this proxy statement/prospectus. Accordingly, no person should rely on the representations and warranties in the Business Combination Agreement or the summaries thereof in this proxy statement/prospectus as characterizations of the actual state of facts about PubCo, PNAC, noco-noco, Merger Sub, New SubCo, any Seller or any other matter.

Capitalized terms in this section not otherwise defined in this proxy statement/prospectus shall have the meanings ascribed to them in the Business Combination Agreement.

### **General Description of the Business Combination Transactions**

In accordance with the terms and subject to the conditions of the Business Combination Agreement, the parties to the Business Combination Agreement have agreed that, in connection with the Closing, the parties shall undertake a series of transactions pursuant to which (i) PNAC shall merge with and into Merger Sub, with PNAC being the surviving company (the "Merger"), (ii) New SubCo shall acquire all of the issued and outstanding shares of noco-noco from the shareholders of noco-noco participating in the transaction, or the Sellers, and in exchange, PubCo shall issue to the Sellers the PubCo Ordinary Shares, with noco-noco becoming a subsidiary of New SubCo and indirect subsidiary of PubCo (the "Share Exchange"). The Merger, Share Exchange, together with the other transactions contemplated by the Business Combination Agreement, shall be collectively referred as the "Business Combination."

### **The Merger**

The Merger shall become effective on the date the Certificate of Merger (as defined therein) being accepted by the Secretary of State of the State of Delaware, but shall only be effective after all conditions set forth in the Business Combination Agreement that are required to be satisfied or waived (other than the conditions that by their terms are to be satisfied at the Merger Closing, but subject to the satisfaction or waiver of such conditions) on or prior to the closing of the Merger or at such other time as may be agreed by noco-noco and PNAC in writing. As a result of the Merger, at the Merger Effective Time, (i) all the property, rights, privileges, powers and franchises, liabilities and duties of PNAC and Merger Sub shall vest in and become the property, rights, privileges, powers and franchises, liabilities and duties of PNAC as the surviving company and the separate corporate existence of Merger Sub shall cease to exist, (ii) each issued and outstanding security of Merger Sub and each issued and outstanding security of PNAC immediately prior to the Merger Effective Time shall be subject to the effects of the Merger as set out below, and (iii) PubCo's memorandum and articles of association shall be amended and restated to read in their entirety in the form attached as Annex B to this proxy statement/prospectus.

Subject to the terms and conditions of the Business Combination Agreement, at the Merger Effective Time:

- each PNAC Unit issued and outstanding immediately prior to the Merger Effective Time shall be automatically detached and the holder thereof shall be deemed to hold one share of PNAC Class A Common Stock, one-half of PNAC Warrant, and one PNAC Right;
- each share of PNAC Common Stock issued and outstanding immediately prior to the Merger Effective Time shall be canceled in exchange for the right to receive one PubCo Ordinary Share;
- each PNAC Warrant outstanding immediately prior to the Merger Effective Time shall cease to be a warrant with respect to PNAC Common Stock and be assumed by PubCo and converted into a warrant of PubCo to purchase one PubCo Ordinary Share, subject to substantially the same terms and conditions prior to the Merger Effective Time in accordance with the provisions of the Warrant Assumption Agreement; and
- each PNAC Right outstanding immediately prior to the Merger Effective Time shall cease to be a right with respect to PNAC Common Stock and be converted into a right to receive one-eighth (1/8) of one PubCo Ordinary Share, subject to substantially the same terms and conditions prior to the effective time of the Merger, simultaneously with the PubCo having taken all necessary corporate actions prior to the Merger Effective Time to issue a total of 806,250 PubCo Ordinary Shares to all holders of PNAC Rights at the Share Exchange Closing.
- if there are any PNAC Common Stock that are owned by PNAC as treasury shares or owned by any direct or indirect subsidiary of PNAC immediately prior to the Merger Effective Time, such PNAC Common Stock shall be canceled for no consideration.
- The sole holder of shares of PubCo issued and outstanding immediately prior to the Merger Effective Time shall, immediately after the Merger Effective Time, sell, transfer and convey all such shares to PubCo for an aggregate of \$0.01 and PubCo shall have taken all corporate action necessary to repurchase such shares, which shares shall thereupon be canceled by PubCo.
- All of the shares of Merger Sub Common Stock issued and outstanding immediately prior to the Merger Effective Time shall be automatically converted into an equal number of shares of Class A common stock of the PNAC, with the same rights, powers and privileges as the shares so converted and shall constitute the only outstanding shares of capital stock of the PNAC.

## ***The Share Exchange***

Following the Merger, subject to the terms and conditions set forth in the Business Combination Agreement, as a result of the Share Exchange, at the Share Exchange Closing (i) each Seller shall transfer its ordinary shares of noco-noco to New SubCo, (ii) each Seller shall receive such number of PubCo Ordinary Share that is equal to the product of (a) the quotient of (i) \$1,350,000,000 (the “noco-noco Valuation”), divided by (ii) the price per PubCo Ordinary Share that equals to the redemption price of each share of PNAC Class A Common Stock in connection with the Business Combination (the “PubCo Per Share Price”), multiplied by (b) such Seller’s Pro Rata Portion as set out in the Allocation Schedule of the Business Combination Agreement.

Subject to the terms and conditions of the Business Combination Agreement, at the Share Exchange Closing:

- noco-noco Shares issued and outstanding immediately prior to the Share Exchange Closing that are owned by the Sellers shall be transferred in exchange for the right to receive such number of newly issued PubCo Ordinary Shares that is set forth in the Allocation Schedule of the Business Combination Agreement.

In addition, pursuant to corporate actions that PubCo shall take prior to the Merger Effective Time, PubCo shall issue 806,250 PubCo Ordinary Shares to such holders of the PNAC Rights at the Share Exchange Closing, with each PNAC right converted into a right to receive one-eighth (1/8) of one PubCo Ordinary Share upon the Merger Effective Time.

The sum of all the PubCo Ordinary Shares and other securities to be issued by PubCo receivable by the Sellers, the holders of PNAC Common Stock is referred to as the “Shareholder Business Combination Consideration.” At or prior to the Merger Effective Time, PubCo shall deposit, or cause to be deposited with VStock as Exchange Agent (or another exchange agent reasonably acceptable to noco-noco) the Shareholder Business Combination Consideration.

## ***Representations and Warranties***

Under the Business Combination Agreement, noco-noco and the Sellers, on the one hand, PNAC and the acquisition entities, on the other hand, have each made customary representations and warranties to each other, including without limitation as to such parties’ organization and standing, due authorization, ownership, no conflict; and in the case of the noco-noco, its liabilities, contracts, labor matters, benefit plans, intellectual properties, insurance, environmental matters, privacy and cybersecurity, anti-corruption compliance, anti-money laundering and trade compliance, permits and licenses, and certain other matters, and in the case of PNAC, disclosure and listing compliance as a public company, and certain other matters. Except in the case of fraud, the representations and warranties in the Business Combination Agreement will not survive the Share Exchange Closing.

The representations and warranties are, in certain cases, subject to specified exceptions and materiality, noco-noco Material Adverse Effect and PNAC material adverse effect (see “—*Material Adverse Effect*” below), knowledge and other qualifications contained in the Business Combination Agreement and may be further modified and limited by the disclosure letters to the Business Combination Agreement.

## ***Material Adverse Effect***

With respect to noco-noco, “noco-noco Material Adverse Effect” means any event, state of facts, development, circumstance, occurrence or effect (collectively, “Events”) that (i) has had, or would reasonably be expected to have, individually or in the aggregate, a material adverse effect on the business, assets and liabilities, results of operations or financial condition of the noco-noco and its Subsidiaries, taken as a whole or (ii) does or would reasonably be expected to, individually or in the aggregate, prevent or materially adversely affect the ability of the noco-noco to consummate the Transactions; provided, that in no event would any of the following, alone or in combination, be deemed to constitute, or be taken into account in determining whether there has been or will be, an Event under clause (i) of the definition of a “noco-noco Material Adverse Effect”:

(a) any change in applicable Laws or FRSs or any interpretation thereof following the date of this Agreement,

(b) any change in interest rates or economic, political, business or financial market conditions generally,

(c) the taking of any action required to be taken under this Agreement,

(d) any natural disaster (including hurricanes, storms, tornados, flooding, earthquakes, volcanic eruptions or similar occurrences), epidemic or pandemic (including any COVID-19 Measures or any change in such COVID-19 Measures or interpretations following the date of the Business Combination Agreement), acts of nature or change in climate, (e) any acts of terrorism or war, the outbreak or escalation of hostilities, geopolitical conditions, local, national or international political conditions,



(f) any failure in and of itself of noco-noco to meet any projections or forecasts (provided that the exception in this clause (f) shall not prevent or otherwise affect a determination that any Event underlying such failure has resulted in or contributed to a noco-noco Material Adverse Effect except where such Event is otherwise excluded under any of clauses (a) through (e) or clauses (g) through (j) of this definition),

(g) any Events generally applicable to the industries or markets in which noco-noco and its Subsidiaries operate,

(h) any action taken by, or at the request of, PNAC, New SubCo, PubCo or Sponsors, or

(i) the announcement of this Agreement and consummation of the Transactions, including any termination of, reduction in or similar adverse impact (but in each case only to the extent attributable to such announcement or consummation) on the noco-noco's and its Subsidiaries' relationships, contractual or otherwise, with third parties;

provided, further, that in the case of each of clauses (a), (b), (c), (d), (e) and (g), any such Event to the extent such Event disproportionately and adversely affects the business, assets, liabilities, results of operations or condition of noco-noco and its Subsidiaries, taken as a whole, relative to other similarly situated participants in the industries in which such Persons operate shall not be excluded from and shall be taken into account in the determination of whether there has been, or would reasonably be expected to be, a noco-noco Material Adverse Effect, but only to the extent of the incremental disproportionate effect on noco-noco and its Subsidiaries, taken as a whole, relative to such similarly situated participants.

### **Covenants of the Parties**

#### *Covenants of noco-noco and the Sellers*

noco-noco made certain covenants under the Business Combination Agreement (subject to the terms and conditions set forth therein), including, among others, the following:

- From the signing date of the Business Combination Agreement through the earlier of the Closing or valid termination of the Business Combination Agreement (the "Interim Period"), subject to certain exceptions, noco-noco shall use reasonable best efforts to operate the business of noco-noco and its subsidiaries in all material respects in the ordinary course consistent with past practice and comply in all material respects with its governing documents and shall not, and shall not permit its subsidiaries to, among other things:
  - change or amend its governing documents, subject to certain exceptions;
  - make or declare any dividend or distribution to the shareholders or make any other distributions in respect of any of its shares or other equity securities;
  - split, combine, reclassify, recapitalize or otherwise amend any terms of any shares or series of equity securities, subject to certain exceptions; or amend any term or alter any rights of any outstanding equity securities;
  - purchase, repurchase, redeem or otherwise acquire any of its issued and outstanding share capital or outstanding equity securities, subject to certain exceptions;
  - enter into, modify in any material respect or terminate (other than expiration in accordance with its terms) any contract of a type required to be listed on noco-noco's disclosure letter, subject to certain exceptions;
  - sell, assign, transfer, convey, lease, exclusively license or otherwise dispose of any material tangible assets or properties, subject to certain exceptions;
  - (i) grant any equity or equity based awards or other severance, retention, change in control or termination or similar pay, (ii) make any change in the key management structure of noco-noco, including the hiring of additional officers or the termination of existing officers, (iii) terminate, adopt, enter into or materially amend any benefit plan, (iv) increase the cash compensation or bonus opportunity of any key executive, officer or director, (v) establish any trust or take any other action to secure the payment of any compensation payable by noco-noco or any of its subsidiaries or (vi) take any action to amend or waive any performance or vesting criteria or to accelerate the time of payment or vesting of any compensation or benefit payable by noco-noco or any of its subsidiaries, in each case subject to certain exceptions (such as required by law or pursuant to Material Contracts);

- (i) acquire (whether by merger, consolidation, amalgamation, scheme or similar transaction, purchase of securities of or otherwise) any corporation, partnership, association, joint venture or other business organization or division thereof; or (ii) make any acquisition of, or investment in, a business, by purchase of stock, securities or assets, contributions to capital, or loans or advances, with a value or purchase price in excess of \$200,000 individually or \$200,000 in the aggregate, subject to certain exceptions;
- issue or sell any debt securities or warrants or other rights to acquire any debt securities of noco-noco or any of its subsidiaries or otherwise incur, assume or guarantee or otherwise become liable for any indebtedness, subject to certain exceptions;
- except in the ordinary course of business consistent with past practice, (i) make or change any material election in respect of material taxes, (ii) materially amend, modify or otherwise change any filed material tax return, (iii) adopt or request permission of any tax authority to change any accounting method in respect of material taxes, (iv) enter into any closing agreement in respect of material taxes executed on or prior to the Closing Date or enter into any tax sharing or similar agreement (other than any such agreement solely between noco-noco and its existing subsidiaries, and customary commercial contracts not primarily related to taxes), (v) settle any claim or assessment in respect of material taxes, or (vi) consent to any extension or waiver of the limitation period applicable to any claim or assessment in respect of material taxes or with respect to any material tax attribute that would give rise to any claim or assessment of taxes;
- take any action, or knowingly fail to take any action, where such action or failure to act could reasonably be expected to prevent the Business Combination Transactions from qualifying for the intended tax treatment, subject to certain exceptions;
- issue any additional shares, equity securities or securities exercisable for or convertible or exchangeable into noco-noco Shares or other equity securities, subject to certain exceptions;
- adopt a plan of, or otherwise enter into or effect a, complete or partial liquidation, dissolution, restructuring, recapitalization or other reorganization;
- waive, release, settle, compromise or otherwise resolve any inquiry, investigation, claim, action, litigation or other legal proceedings, except in the ordinary course of business or where such waivers, releases, settlements or compromises involve only the payment of monetary damages in an amount less than \$200,000 in the aggregate;
- grant to, or agree to grant to, any person rights to any intellectual property or software that is material to noco-noco and its subsidiaries, taken as a whole, or dispose of, abandon or permit to lapse any rights to any intellectual property that is material to noco-noco and its subsidiaries, taken as a whole, subject to certain exceptions;
- make or commit to make capital expenditures other than in an amount not in excess of \$200,000 in the aggregate;
- manage noco-noco and its subsidiaries' working capital (including paying amounts payable in a timely manner when due and payable) in a manner other than in the ordinary course of business consistent with past practice;
- terminate without replacement, or fail to use reasonable efforts to maintain any license material to the conduct of the business of noco-noco and its subsidiaries, taken as a whole;
- waive the restrictive covenant obligations of any current or former employee of noco-noco or any of its subsidiaries;

- limit the right of noco-noco or any of its subsidiaries to engage in any line of business or in any geographic area, to develop, market or sell products or services, or to compete with any person or grant any exclusive or similar rights to any person, subject to certain exceptions;
  - terminate without replacement or amend in a manner materially adverse to noco-noco and its subsidiaries, taken as a whole, any insurance policy insuring any risks of the business of noco-noco or any of its subsidiaries;
  - make any material change in its accounting principles or methods unless required by applicable law or applicable accounting standards; or
  - enter into any agreement to do any of the foregoing.
- During the Interim Period, noco-noco shall not and shall direct its controlled, controlling and common control affiliates and its and their respective representatives not to directly or indirectly (i) solicit, initiate or pursue any inquiry, indication of interest, proposal or offer with any third party with respect to a noco-noco acquisition proposal, (ii) participate in or continue any discussions or negotiations with any third party with respect to, or furnish or make available any information concerning noco-noco or any of its subsidiaries to any third party relating to a noco-noco acquisition proposal or provide to any third party access to the businesses, properties, assets or personnel of noco-noco or any of its subsidiaries, in each case for the purpose of encouraging or facilitating a noco-noco acquisition proposal, (iii) enter into any binding understanding, binding arrangement, acquisition agreement, merger agreement or similar definitive agreement, or any letter of intent, memorandum of understanding or agreement in principle, or any other agreement with respect to a noco-noco acquisition proposal, or (iv) grant any waiver, amendment or release under any confidentiality agreement or otherwise knowingly facilitate any such inquiries, proposals, discussions or negotiations or any effort or attempt by any person to make, a noco-noco acquisition proposal. noco-noco shall, and shall instruct its officers and directors to, and shall instruct and cause its representatives, subsidiaries and their respective representatives to, immediately cease and terminate all discussions and negotiations with any persons (other than PNAC and its representatives) with respect to a noco-noco acquisition proposal from and after the date of the Business Combination Agreement. A noco-noco acquisition proposal includes, but is not limited to, (i) any acquisition which would result in any third party beneficially owning any shares of noco-noco or any of its subsidiaries, (ii) any merger, acquisition, business combination or other similar transaction involving noco-noco or any of its subsidiaries, the business of which constitutes 15% or more of the net revenues, net income or assets of noco-noco or any of its subsidiaries, (iii) commencing any work in relation to an initial public offering with any stock exchange, and (iv) any liquidation or other significant corporate reorganization of noco-noco or any of its Subsidiaries, the business of which constitutes 15% or more of the net revenues, net income or assets of noco-noco or any of its subsidiaries, provided that, any transactions contemplated in connection with the Permitted Activities under the Business Combination Agreement, or any transaction relating to backstop financing of the Transactions would not be a noco-noco acquisition proposal.
- During the Interim Period, noco-noco shall promptly (and in any event prior to the Share Exchange Closing) notify PNAC in writing, upon noco-noco or any of its subsidiaries becoming aware (awareness being determined with reference to the knowledge of noco-noco) of: (a) the occurrence or non-occurrence of any event the occurrence or non-occurrence of which has caused or is reasonably likely to cause any condition to the obligations of noco-noco to effect the Business Combination Transactions not to be satisfied, (b) any breach of a representation or warranty given by noco-noco in the Business Combination Agreement, or (c) any notice or other communication from any governmental authority which is reasonably likely, individually or in the aggregate, to have a material adverse effect on the ability of the parties hereto to consummate the Business Combination Transactions or to materially delay the timing thereof.

*Covenants of PNAC, PubCo, Merger Sub and New SubCo*

PNAC, PubCo, Merger Sub and New SubCo made certain covenants under the Business Combination Agreement (subject to the terms and conditions set forth therein), including, among others, the following:

- upon satisfaction or waiver of the conditions set forth in the Business Combination Agreement and provision of notice thereof to the trustee in accordance with the terms of the Trust Agreement, PNAC shall cause at Closing (i) any documents, opinions and notices required to be delivered to the Trustee pursuant to the Trust Agreement to be so delivered; and (ii) shall use its reasonable best efforts to cause the Trustee to (a) pay as and when due all amounts payable to shareholders of PNAC pursuant to the PNAC share redemptions and pay to the underwriters of the PNAC IPO all outstanding deferred underwriting commissions; and (b) pay all remaining amounts then available in the Trust Account to be made available to PNAC in accordance with the Trust Agreement, subject to the Business Combination Agreement and the Trust Agreement;
- PNAC shall ensure PNAC remains listed as a public company on the Nasdaq from the date of the Business Combination Agreement until the closing of the Merger. PubCo shall apply for, and shall use reasonable best efforts to cause, the PubCo Ordinary Shares to be issued in connection with the Business Combination Transactions to be approved for, listing on the Nasdaq and accepted for clearance by DTC, subject to official notice of issuance, prior to the Closing Date;
- during the Interim Period, subject to certain exceptions, PNAC, PubCo, Merger Sub and New SubCo, shall use reasonable best efforts to operate its respective business in the ordinary course consistent with past practice and comply in all material respects with its governing documents and shall not:
  - change, modify or amend the Trust Agreement (with respect to PNAC only) or its governing documents, or seek any approval from its shareholders to do so, except as contemplated by the Business Combination Proposal and the Governing Documents Proposal;
  - merge, consolidate or amalgamate with or into, or acquire (by purchasing a substantial portion of the assets of or equity in, or by any other manner) any other person or be acquired by any other person;
  - make or declare any dividend or distribution to its respective shareholders or make any other distributions in respect of any of its equity securities;
  - split, combine, reclassify or otherwise amend any terms of any of its equity securities;
  - purchase, repurchase, redeem or otherwise acquire any of its issued and outstanding equity securities, other than, in the case of PNAC only, redemptions of PNAC Common Stock made as part of PNAC share redemptions;
  - except in the ordinary course of business consistent with past practice, (i) make or change any material election in respect of material taxes, (ii) materially amend, modify or otherwise change any filed material tax return, (iii) adopt or request permission of any tax authority to change any accounting method in respect of material taxes, (iv) enter into any closing agreement in respect of material taxes or enter into any tax sharing or similar agreement (other than customary commercial contracts not primarily related to taxes), (v) settle any claim or assessment in respect of material taxes, or (vi) consent to any extension or waiver of the limitation period applicable to any claim or assessment in respect of material taxes or with respect to any material tax attribute that would give rise to any claim or assessment of taxes;
  - take any action, or knowingly fail to take any action, where such action or failure to act could reasonably be expected to prevent the Business Combination Transactions from qualifying for the intended tax treatment, except as contemplated by the Business Combination Agreement or the Business Combination Transactions;
  - enter into, renew or amend in any material respect, any contract with the Sponsors or an affiliate of PNAC (including any person in which either Sponsors has a direct or indirect legal or beneficial ownership interest of 5% or greater and any person who has a direct or indirect legal or beneficial ownership interest of 5% or greater in the Sponsors), subject to certain exceptions;
  - incur, guarantee or otherwise become liable for any indebtedness, subject to certain exceptions;
  - issue any equity securities or securities exercisable for or convertible into equity securities, other than, in the case of PNAC only, issuances of new PNAC Common Stock issued to the Sponsors in respect of the capitalization of any working capital loans of no more than \$3 Million, or issuances of PNAC Common Stock issuable upon, or subject to, the exercise or settlement of the PNAC Warrants, and in the case of PubCo only, the issuance of equity securities of PubCo;

- grant any options, warrants or other equity-based awards with respect to any equity securities not outstanding on the date of the Business Combination Agreement;
  - in the case of PNAC and PubCo only, amend, modify or waive any of the terms or rights set forth in any PNAC Warrant or the Warrant Agreement, other than pursuant to the Business Combination transaction documents;
  - make any change in accounting principles or methods unless required by U.S. GAAP;
  - form any subsidiary;
  - liquidate, dissolve, reorganize or otherwise wind-up its business and operations; or
  - amend, waive or assign any material right under any material Contract to which PNAC is a party; waive, release, assign, settle or compromise any claim, action or proceeding, other than waivers, releases, assignments, settlements or compromises that involve only the payment of monetary damages not in excess of \$1,000,000, or otherwise pay, discharge or satisfy any Actions, Liabilities or obligations, in each case due and payable only before the Share Exchange Closing;
  - enter into any agreement to do any action prohibited under any of the foregoing.
- During the Interim Period, PNAC shall not and shall direct the Sponsors and their controlled affiliates and its and their respective officers, directors and representatives not to directly or indirectly (i) solicit, initiate, or pursue any inquiry, indication of interest, proposal or offer with respect to a PNAC acquisition proposal, (ii) participate in or continue any discussions or negotiations with any third party with respect to, or furnish or make available any information concerning PNAC to any third party relating to a PNAC acquisition proposal, or provide to any third party access to the businesses, properties, assets or personnel of PNAC, in each case for the purpose of encouraging or facilitating a PNAC acquisition proposal, (iii) enter into any binding understanding, binding arrangement, acquisition agreement, merger agreement or similar definitive agreement, or any letter of intent, memorandum of understanding or agreement in principle, or any other agreement with respect to a PNAC acquisition proposal, or (iv) grant any waiver, amendment or release under any confidentiality agreement or otherwise knowingly facilitate any such inquiries, proposals, discussions, or negotiations or any effort or attempt by any person to make, a PNAC acquisition proposal. PNAC shall, and shall direct the Sponsor and its controlled affiliates and its and their respective officers, directors and representatives to, immediately cease and terminate all discussions and negotiations with any persons (other than noco-noco and its representatives) with respect to a PNAC acquisition proposal. A PNAC acquisition proposal means (i) any business combination involving PNAC or any of its controlled affiliates or involving all or a material portion of the assets, equity securities or businesses of PNAC or its controlled affiliates; or (ii) any equity or similar investment in or by PNAC and/or any of its controlled affiliates, in each case, other than the Business Combination
  - During the Interim Period, PNAC shall use reasonable efforts to keep current and timely file all reports required to be filed or furnished with the SEC and otherwise comply in all material respects with its reporting obligations under applicable laws.
  - Prior to the Closing Date, PNAC shall take all such steps (to the extent permitted under applicable law) as are reasonably necessary to cause any acquisition or disposition of PubCo Ordinary Shares or any derivative thereof that occurs or is deemed to occur by reason of or pursuant to the Business Combination Transactions by each person who is or will be or may become subject to Section 16 of the Exchange Act with respect to PubCo, including by virtue of being deemed a director by deputation, to be exempt under Rule 16b-3 promulgated under the Exchange Act.
  - In the event that any litigation related to the Business Combination Agreement, any other transaction document or the transactions contemplated thereby is brought, or, to the knowledge of PNAC, threatened in writing, against PNAC, PubCo, Merger Sub, New SubCo or their respective board of directors by any PNAC stockholders prior to the Closing, PNAC shall promptly after becoming aware of such litigation notify noco-noco and keep it reasonably informed with respect to the status thereof. PNAC, PubCo, Merger Sub, or New SubCo shall provide noco-noco the opportunity to participate in (at its own cost and subject to a customary joint defense agreement), but not control, the defense of any such litigation, and shall consider in good faith noco-noco's suggestions with respect to such litigation and shall not settle any such litigation without the prior written consent of noco-noco, such consent not to be unreasonably withheld, conditioned, delayed or denied.

- PubCo shall exercise its rights as the sole shareholder of New SubCo in so far as it is able to cause New SubCo to approve the Share Exchange, including by voting in favor of the Business Combination proposal.
- During the Interim Period, PNAC shall promptly (and in any event prior to the Share Exchange Closing) notify Acquiror in writing, upon any of PNAC, PubCo, Merger Sub or New SubCo becoming aware (awareness being determined with reference to the knowledge of PNAC) of: (a) the occurrence or non-occurrence of any event the occurrence or non-occurrence of which has caused or is reasonably likely to cause any condition to the obligations of any of them to effect the Business Combination Transactions not to be satisfied, (b) any breach of a representation or warranty given by any of them in the Business Combination Agreement or (c) any notice or other communication from any governmental authority which is reasonably likely, individually or in the aggregate, to have a material adverse effect on the ability of the parties hereto to consummate the Business Combination Transactions or to materially delay the timing thereof.
- PNAC, PubCo, Merger Sub and New SubCo shall have used reasonable best efforts to obtain the Transaction Financing on the terms mutually agreed to by noco-noco and PNAC, in an amount that is at least \$20,000,000 prior to or upon the Share Exchange Closing.

*Joint Covenants*

The Business Combination Agreement also contains certain other covenants and agreements among the various parties, including, among others, that each of PubCo, noco-noco, the Sellers, PNAC, Merger Sub and New SubCo, subject to the terms and conditions contained therein:

- use commercially reasonable efforts to cooperate in good faith with any governmental authority and use commercially reasonable efforts to undertake promptly any and all action required to obtain any necessary or advisable regulatory approvals, consents, actions, nonactions or waivers in connection with the Business Combination Transactions as soon as practicable and any and all action necessary to consummate the Business Combination Transactions, and to use commercially reasonable efforts to cause the expiration or termination of the waiting, notice or review periods under any applicable regulatory approval with respect to the Business Combination Transactions as promptly as reasonably possible; and
- diligently and expeditiously defend and use reasonable best efforts to obtain any necessary clearance, approval, consent or governmental authorization under any applicable laws prescribed or enforceable by any governmental authority for the transactions contemplated by the Business Combination Agreement and to resolve any objections as may be asserted by any governmental authority with respect to the transactions contemplated by the Business Combination Agreement, and cooperate in good faith with each other in the defense of such matters; and

Further, the Business Combination Agreement also contains additional covenants and agreements among the parties thereto in respect of, among other matters:

- use reasonable best efforts to obtain all material consents and approvals of third parties that such party is required to obtain in order to consummate the Merger and the Share Exchange, and take such other action as may be reasonably necessary or as another party hereto may reasonably request to satisfy the conditions for the consummation of the Business Combination Transactions

- preparing, filing and distributing this proxy statement/prospectus on Form F-4 (including any amendments or supplements thereto);
- confidentiality and publicity matters, including the issuance of the applicable signing and closing press release, and submission of regulatory filings;
- tax matters, including with respect to the intended tax treatment;
- litigation matters with respect to the Business Combination Transactions;
- none of noco-noco, PNAC, PubCo, Merger Sub and New SubCo shall acknowledge or accept a joinder to the Business Combination Agreement by a shareholder of noco-noco that is not a noco-noco Insider prior to the effective date of this proxy/registration statement;
- each shareholder of noco-noco holding 10% or more of the shares of noco-noco immediately prior to the Share Exchange Closing agrees to enter into a non-disclosure, non-competition and non-solicitation agreement and each of noco-noco and PNAC, PubCo, Merger Sub and New SubCo will procure the execution and delivery of PubCo employment agreement by each PubCo executive officers on or prior to the Share Exchange Closing; and

upon the Share Exchange Closing, the board of directors of PubCo shall consist of seven (7) directors consisting of seven (7) directors designated by noco-noco prior to the Share Exchange Closing (including two (2) independent directors that are qualified as “independent” under Nasdaq rules) that satisfy Nasdaq Diverse Board Representation Rule provided that noco-noco shall cause PubCo after the Share Exchange to comply with applicable Nasdaq rule to follow a home country practice, and the officers of PubCo shall consist of the officers of noco-noco as of immediately prior to the Share Exchange Closing, who shall serve in such capacity in accordance with the terms of PubCo’s Governing Documents following the Share Exchange Closing, until their respective successors are duly elected or appointed and qualified;

- indemnification of present and former directors and officers of noco-noco, PNAC, PubCo, Merger Sub, and New SubCo and their respective subsidiaries and maintaining in effect liability insurances covering those persons who are currently covered by directors’ and officers’ liability insurance policies of noco-noco, PNAC, PubCo, Merger Sub, New SubCo or their respective subsidiaries.

### ***Conditions to Closing***

Unless waived by each party in writing, the obligations of each party to consummate, or cause to be consummated, the Merger at the Merger Closing are subject to the satisfaction of the following conditions:

- approval of the Business Combination by the PNAC stockholders and approval of the Business Combination by the noco-noco shareholders;
- the effectiveness of the Form F-4 and no stop order suspending the effectiveness of the Form F-4 shall have been issued, and no proceedings for that purpose having been initiated or threatened by the SEC and not withdrawn;
- PubCo’s initial listing application with the Nasdaq in connection with the Business Combination Transactions having been conditionally approved and, immediately following the Closing, PubCo satisfying any applicable initial and continuing listing requirements of the Nasdaq and PubCo having not received any notice of non-compliance therewith;
- receipt of approval for PubCo Ordinary Shares to be listed on the Nasdaq, subject only to official notice of issuance;

- no governmental authority having enacted, issued, promulgated, enforced or entered any law (whether temporary, preliminary or permanent) or governmental order that is then in effect and which has the effect of making the Merger Closing or the Closing illegal or which otherwise prevents or prohibits the consummation of the Merger Closing or the Closing (any of the foregoing, a “restraint”), other than any such restraint that is immaterial, or for which the relevant governmental authority does not have jurisdiction over any of the parties to the Business Combination Agreement with respect to the Business Combination Transactions;
- no noco-noco Material Adverse Effect; and
- PubCo having at least \$5,000,001 of net tangible assets (as determined in accordance with Rule 3a51 1(g)(1) of the Exchange Act) remaining after accounting for its share redemptions.

Unless waived by PNAC in writing, the obligations of PNAC, Merger Sub and PubCo to consummate, or cause to be consummated, the Merger at the Merger Closing are also subject to the satisfaction of each of the following conditions:

- each of the representations and warranties of the Sellers and noco-noco shall be true and correct in all material respects as of the Merger Closing Date, and representations and warranties which speak as to an earlier date, which representations and warranties shall be true and correct in all material respects at and as of such date; and
- each of the covenants of the Sellers and noco-noco to be performed as of or prior to the Merger Closing having been performed in all material respects;

Unless waived by PubCo, New SubCo, and noco-noco in writing, the obligations of PubCo, New SubCo and noco-noco to consummate, or cause to be consummated, the Share Exchange to occur at the Closing are also subject to the satisfaction of each the following conditions:

- the Merger Effective Time having occurred;
- since the Merger Effective Time, no stop order suspending the effectiveness of the Form F-4 having been issued and no proceedings for that purpose having been initiated or threatened by the SEC and not withdrawn;
- since the Merger Effective Time, PubCo having continued to satisfy any applicable initial and continuing listing requirements of the Nasdaq and PubCo having not received any notice of non-compliance therewith and the PubCo Shares to be issued in connection with the Share Exchange shall continue to be approved for listing on the Nasdaq, subject to official notice of issuance;
- since the Merger Effective Time, no governmental authority having enacted, issued, promulgated, enforced or entered any law (whether temporary, preliminary or permanent) or governmental order that is then in effect and which has the effect of making the Closing illegal or which otherwise prevents or prohibits the consummation of the Closing (any of the foregoing, an “share exchange restraint”), other than any such share exchange restraint that is immaterial, or for which the relevant governmental authority does not have jurisdiction over any of the parties to the Business Combination Agreement with respect to the Business Combination Transactions.

Unless waived by PubCo and New SubCo in writing, the obligations of PubCo and New SubCo to consummate, or cause to be consummated, the Share Exchange at the Closing are also subject to the satisfaction of the following condition:

- the representations and warranties of the Sellers and noco-noco shall be true and correct in all material respects as of the Share Exchange Closing Date, and representations and warranties which speak as to an earlier date, which representations and warranties shall be true and correct in all material respects at and as of such date; and



- each of the covenants of the Sellers and noco-noco to be performed as of or prior to the Share Exchange Closing having been performed in all material respects.

Unless waived by noco-noco in writing, the obligations of noco-noco and the Sellers to consummate, or cause to be consummated, the Share Exchange at the Closing are also subject to the satisfaction of the following conditions:

- each of the representations and warranties of PNAC, PubCo, Merger Sub and New SubCo shall be true and correct in all material respects as of the Share Exchange Closing Date, and representations and warranties which speak as to an earlier date, which representations and warranties shall be true and correct in all material respects at and as of such date; and
- each of the covenants of PNAC, PubCo and New SubCo to be performed as of or prior to the Share Exchange Closing having been performed in all material respects.
- the Available PNAC Cash shall be at least \$20,000,000 immediately prior to or upon the Share Exchange Closing.
- the Post-Combination PubCo Charter and PubCo Incentive Plan shall have been duly adopted and shall have remained in full force and effect.
- each of the PNAC, Merger Sub, PubCo and New SubCo shall have delivered to noco-noco a good standing certificate as of a date no earlier than twenty (20) days prior to the Share Exchange Closing Date from the proper governmental authority of such entity's jurisdiction of organization and from each other jurisdiction in which such entity is qualified to do business as a foreign entity as of the Share Exchange Closing, in each case to the extent that good standing certificates or similar documents are generally available in such jurisdictions.
- all Transaction Documents shall have been executed and delivered by the other parties thereto and been in full force and effect in accordance with the terms thereof as of the Share Exchange Closing.

### **Termination**

The Business Combination Agreement may be terminated by PNAC or noco-noco under certain circumstances, including, among others, (i) by written consent of noco-noco and PNAC; (ii) by PNAC or noco-noco, if any actions taken by such Governmental Order or Law makes the Merger Closing or Share Exchange Closing illegal or otherwise prevents or prohibits consummation of the Merger Closing or Share Exchange Closing; (iii) by noco-noco if PNAC fails to obtain the required vote at a Stockholders' Meeting duly convened therefor or at any adjournment or postponement thereof; and (iv) with respect to noco-noco on one hand, and PNAC on the other, the other party's breach of any representation, warranty, covenant or agreement as set forth in the Business Combination Agreement and failure to cure such breach within a certain period.

In the event of termination of the Business Combination Agreement, the Business Combination Agreement shall forthwith become void and have no effect, without any liability on the part of any party thereto or its respective affiliates, officers, directors or shareholders, other than liability of any party thereto for any willful and material breach of the Business Combination Agreement by such party prior to such termination; provided that obligations under the clauses relating to confidentiality, public announcement, transfer taxes and certain obligations related to the Trust Account and certain other provisions of the Business Combination Agreement shall, in each case, survive any termination of the Business Combination Agreement.

### ***Enforcement***

Each party is entitled under the Business Combination Agreement to an injunction or injunctions to prevent breaches of the Business Combination Agreement and to specific enforcement of the terms and provisions of the Business Combination Agreement, in addition to any other remedy to which any party is entitled at law or in equity.

### ***Non-Recourse***

Except in the case of claims against a party in respect of such party's fraud, all claims or causes of action that are based upon, arising out of, or related to the Business Combination Agreement or the Business Combination Transactions contemplated therein may be made only against noco-noco, PubCo, PNAC, Merger Sub and New SubCo named as parties to the Business Combination Agreement.

Further, subject to fraud exception, unless a named party to the Business Combination Agreement, and then only to the extent of the specific obligations undertaken by such named party under the Business Combination Agreement, no past, present or future director, commissioner, officer, employee, incorporator, member, partner, shareholder, representative or affiliate of any of the foregoing shall have any liability (whether in contract, tort, equity or otherwise) for any one or more of the representations, warranties, covenants, agreements or other obligations or liabilities of any one or more of noco-noco, PubCo, PNAC, Merger Sub, and New SubCo for any claim based on, arising out of, or related to the Business Combination Agreement or the Business Combination Transactions. Furthermore, there will be no recourse against the Trust Account in connection with any such claims or causes of action.

### ***Non-Survival of Representations, Warranties and Covenants***

Except, in the event of termination of the Business Combination Agreement, for obligations under such confidentiality agreement and certain obligations related to the Trust Account and certain other provisions of the Business Combination Agreement, or in the case of claims against a person in respect of such person's actual fraud, none of the representations, warranties, covenants, obligations or other agreements in the Business Combination Agreement, or in any certificate, statement or instrument delivered pursuant to the Business Combination Agreement, including any rights arising out of any breach of such representations, warranties, covenants, obligations, agreements and other provisions, shall survive the Closing and shall terminate and expire upon the occurrence of the Share Exchange Closing (and there shall be no liability after the Closing in respect thereof) except for (i) any covenants and agreements contained therein that expressly by their terms apply either in part or in whole after the Closing and then only with respect to any breaches occurring after the Closing and (ii) the miscellaneous provisions thereof, which include, among others, provisions regarding Trust Account waiver, waiver, notice, assignment, no third-party rights, expenses, headings and counterparts, disclosure letters, entire agreement, amendments, publicity, severability and conflicts and privilege.

### ***Governing Law and Jurisdiction***

The Business Combination Agreement is governed by Delaware law. Any action based upon, arising out of or related to the Business Combination Agreement or the Business Combination Transactions contemplated thereby shall be brought in federal and state courts located in the State of Delaware. Each party has waived its rights to trial by jury in any action based upon, arising out of or related to the Business Combination Agreement or the Business Combination Transactions contemplated thereby.

### ***Related Agreements***

This section describes the material provisions of certain additional agreements entered into or to be entered into pursuant to the Business Combination Agreement but does not purport to describe all of the terms thereof. The following summary is qualified in its entirety by reference to the complete text of each of the Related Agreements, and you are urged to read such Related Agreements in their entirety.

## Lock-up Agreements

Prior to the Merger Effective Time, certain Sellers and the PNAC Initial Stockholders will enter into lock-up agreements with the PNAC and PubCo (the “Lock-up Agreement”).

Pursuant to the Lock-Up Agreement, PubCo Ordinary Shares held by such holders are categorized as (i) “Group I Lock-up Shares”, referring to the 50% of the total number of PubCo Ordinary Shares that such Seller will receive in connection with the Share Exchange, or 50% of the number of PubCo Ordinary Shares such Holder will receive in converting their PNAC Founder Shares in connection with the Merger, (ii) “Group II Lock-up Shares”, referring to the remaining 50% of the total number of PubCo Ordinary Shares that such Seller will receive in connection with the Share Exchange, or 50% of the number of PubCo Ordinary Shares such Holder will receive in converting its PNAC Founder Shares in connection with the Merger; and (iii) “Group III Lock-up Shares”, referring to the total number of PubCo Ordinary Shares that such Holder will receive in converting its PNAC Private Shares in connection with the Merger. The Group I Lock-Up Shares, Group-II Lock-up Shares, Group-III Lock-up Shares shall be collectively referred as “Lock-up Shares”.

The “Lock-up Period” means (i) with respect to the Group I Lock-up Shares, the period commencing on the Share Exchange Closing Date and ending on the date that is the earlier to occur of (A) six months there-after, or (B) the date on which the closing price of each PubCo Ordinary Share equals or exceeds \$12.50 per share (as adjusted for share splits, share dividends, reorganizations and recapitalizations) for any 20 trading days within any 30-trading day period commencing after the completion of the Share Exchange; (ii) with respect to the Group II Lock-up Shares, the period commencing on the Share Exchange Closing Date and ending on the date that is six months thereafter; (iii) with respect to the Group III Lock-up Shares, the period commencing on the Share Exchange Closing Date and ending on the 30 days thereafter.

The holders will, subject to certain customary exceptions, agree not to, within the Lock-up Period, (i) sell, offer to sell, contract or agree to sell, pledge or otherwise dispose of, directly or indirectly, any Lock-up Shares, (ii) enter into a transaction that would have the same effect, (iii) enter into any swap, hedge or other arrangement that transfers to another, in whole or in part, any of the economic consequences of ownership of the Lock-Up Shares or otherwise or engage in any short sales or other arrangement with respect to the Lock-Up Shares or (iv) publicly announce any intention to effect any transaction specified in clause (i) or (ii).

## Registration Rights Agreement

Prior to the Share Exchange Closing, PubCo and certain holders of PubCo Ordinary Shares (including PNAC Initial Stockholders and the Sellers) will enter into the Registration Rights Agreement, to be effective upon the Closing pursuant to which, among other things, PubCo will agree to undertake certain resale shelf registration obligations in accordance with the Securities Act and the holders have been granted certain demand and piggyback registration rights. See “Shares Eligible for Future Sale—Registration Rights.”

## Warrant Assumption Agreement

Prior to the Merger Closing, PNAC, PubCo and VStock will enter into the Warrant Assumption Agreement, pursuant to which, among other things, PNAC shall have assigned all of its rights, interests and obligations in the Existing Warrant Agreement to PubCo effective upon the Merger Closing, and PubCo shall have assumed the warrants provided for under the Existing Warrant Agreement.

## Organizational Structure

The following simplified diagram illustrates the ownership structure of PubCo immediately following the consummation of the Business Combination under the no redemption scenario:

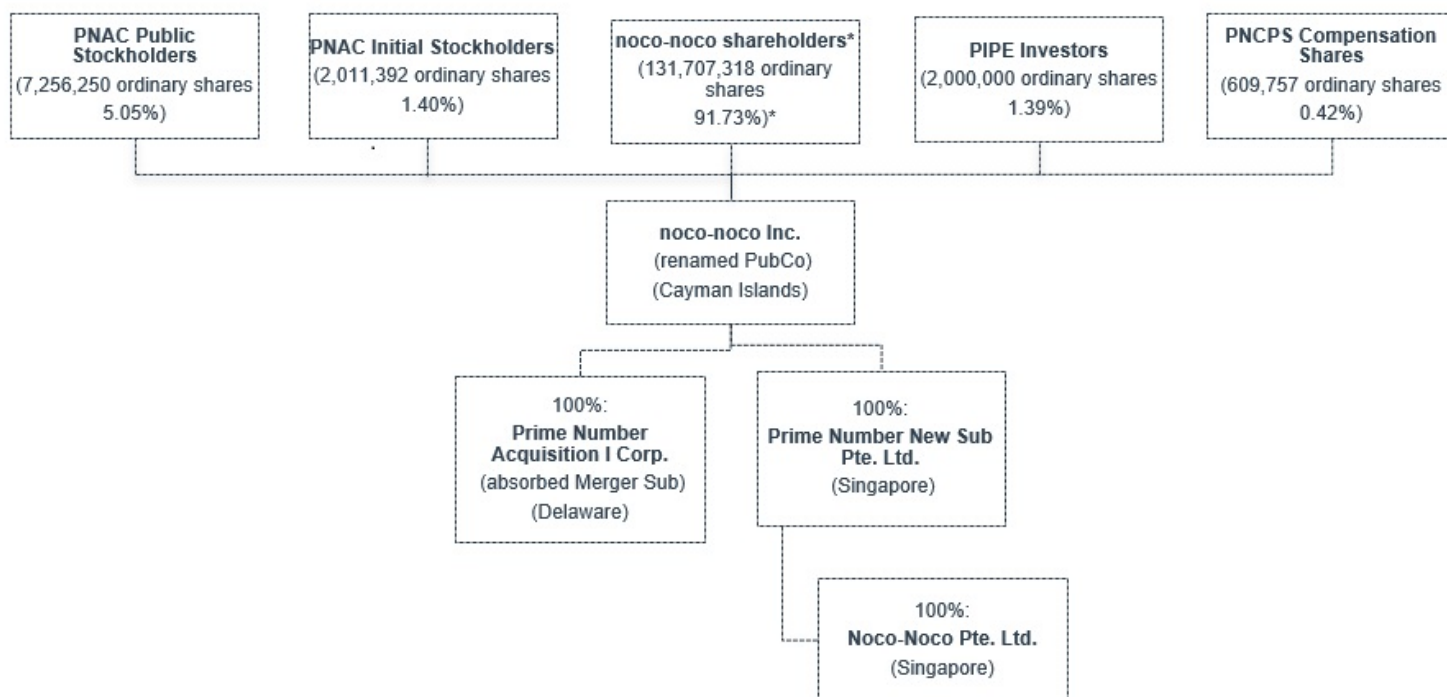

\*assuming that all noco-noco shareholders will participate in the Share Exchange as provided in the Business Combination Agreement.

The following simplified diagram illustrates the ownership structure of PubCo immediately following the consummation of the Business Combination under the maximum redemption scenario.

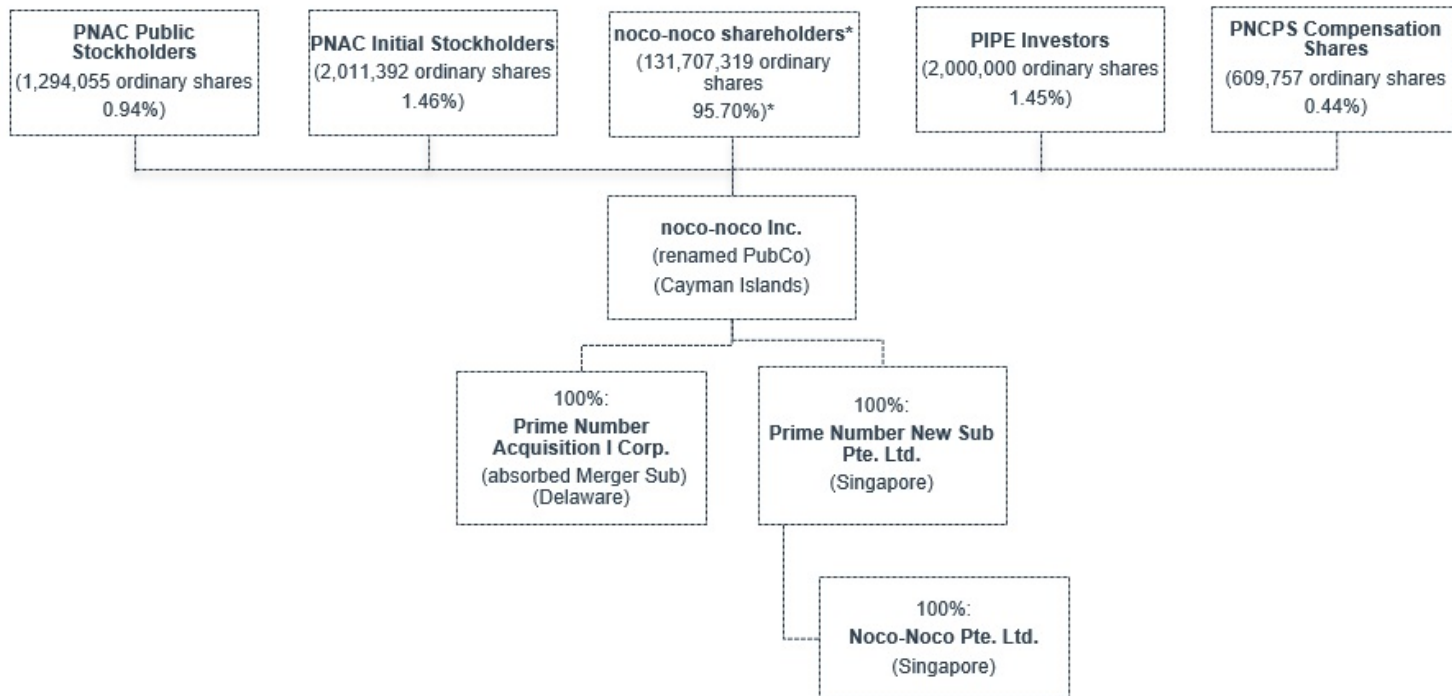

\*assuming that all noco-noco shareholders will participate in the Share Exchange as provided in the Business Combination Agreement.

## **Charter Documents of PubCo Following the Business Combination**

Pursuant to the Business Combination Agreement, upon the Merger Closing, PubCo's memorandum and articles of association shall be amended. See "*Description of PubCo Securities*," for a description of the Amended PubCo Charter and "*Comparison of Corporate Governance and Shareholder Rights*" for a comparison to the provisions of PNAC's organizational documents.

## **Stock Exchange Listing of PubCo Ordinary Shares**

PubCo has applied for, and shall use reasonable best efforts to cause, the PubCo Ordinary Shares to be issued in connection with the Business Combination to be approved for, listing on the Nasdaq and accepted for clearance by DTC.

## **Delisting and Deregistration of PNAC Common Stock**

If the Business Combination is completed, shares of PNAC Class A Common Stock shall be delisted from Nasdaq and shall be deregistered under the Exchange Act.

## **Headquarters**

After completion of the transactions contemplated by the Business Combination Agreement, the corporate headquarters and principal executive office of PubCo will be located at 4 Shenton Way, #04-06 SGX Centre II, Singapore 068807.

## **Background of the Business Combination**

The terms of the Business Combination are the result of arms-length negotiations between PNAC and noco-noco, and their respective representatives. The following is a brief description of the background of these negotiations.

PNAC is a blank check company incorporated on February 25, 2021 as a Delaware corporation and formed for the purpose of entering into a merger, capital stock exchange, asset acquisition, stock purchase, reorganization, or similar business combination with one or more businesses. As provided in PNAC's governing documents, PNAC will not undertake initial business combination with any company being based in or having the majority of the company's operations in China (including Hong Kong and Macau).

PNAC's efforts to identify a potential business combination target were not limited to a particular industry. Although PNAC intended to focus search on technology-enabled sectors including but not limited to blockchain, data center, non-fungible token, ecommerce and other technology related infrastructure sectors, PNAC is not required to complete their initial business combination with a business in these industries and, as a result, PNAC pursued opportunities in addition to opportunities in these industries.

## **PNAC's Initial Public Offering**

On May 17, 2022, PNAC completed its initial public offering of 6,450,000 PNAC Units, which included 450,000 PNAC Units issued upon the partial exercise of the underwriters' over-allotment option. Each PNAC Unit consists of one share of PNAC Class A Common Stock, one-half of one redeemable PNAC Warrant, each whole PNAC Warrant entitles the holder thereof to purchase one share of PNAC Class A Common Stock at a price of \$11.50 per share, and one PNAC Right, with each right entitles the holder thereof to receive one-eighth (1/8) of one share of PNAC Class A Common Stock upon the completion of an initial business combination. The PNAC Units were sold at an offering price of \$10.00 per unit, generating gross proceeds of \$64,500,000.

Substantially concurrently with the completion of PNAC IPO, PNAC completed private sale of 398,892 shares of the PNAC Private Shares to the Sponsors, including 349,032 shares to Sponsor A, and 49,860 shares to Sponsor B, at a purchase price of \$10.00 per PNAC Class A Common Stock, generating gross proceeds to PNAC of \$3,988,920 (including \$3,490,320 from Prime Number Acquisition LLC and \$498,600 from Glorious Capital LLC).

The net proceeds from PNAC IPO and proceeds from the simultaneous private placements in a total amount of \$65,790,000 (or \$10.20 per public share) were placed in the Trust Account.

On May 15, 2023, PNAC held a special meeting of stockholders where PNAC stockholders approved the proposal to amend the PNAC's amended and restated certificate of incorporation to allow PNAC until May 17, 2023 to consummate an initial business combination, and to elect to extend the period to consummate an initial business combination up to six times, each by an additional one-month period (each a "Monthly Extension"), for a total of up to six months to November 17, 2023 (the "Final Termination Date"), by depositing to PNAC's Trust Account \$125,000 for each one-month extension. On May 17, 2023, PNAC filed a certificate of amendment to the amended and restated certificate of incorporation, effective on the same date, to effectuate the proposal.

In connection with the votes to approve the proposal, 1,537,701 PNAC Public Shares were tendered for redemption on May 13, 2023, and were cancelled on May 22, 2023. As of the date of this proxy statement/prospectus, a total of 4,912,299 PNAC Public Shares are issued and outstanding. On May 17, 2023, an aggregate of \$125,000 was deposited into the Trust Account for the PNAC Public Stockholders, resulting in the first Monthly Extension by one month from May 17, 2023 to June 17, 2023 to allow for PNAC to consummate the Business Combination. On June 14, 2023, an additional of \$125,000 was deposited into the Trust Account for the PNAC Public Stockholders, resulting in the second Monthly Extension by one month from June 17, 2023 to July 17, 2023 to allow for PNAC to consummate the Business Combination.

## Target Search

After the consummation of the PNAC IPO, PNAC's management began their search for a suitable target for a business combination. In addition, they were contacted by a number of individuals and entities with respect to potential business combination opportunities.

Although PNAC intended to focus its search for a target business in technology-enabled sectors, PNAC was able to seek a business combination with an operating company in any industry or sector. PNAC viewed potential acquisition targets based on the same criteria discussed below and used in evaluating the business combination. These criteria included, without limitation, businesses (i) that demonstrates attractive long-term growth prospects and an ability to lead or consolidate the industry; (ii) that is poised for high growth due to disruptive technology, superior product offerings, and/or shifting customer preferences; (iii) with the potential to generate stable and increasing free cash flows, with which we may also seek to prudently leverage the cash flows to enhance stockholder value; (iv) that we believe present the potential for revenue and earnings growth through a combination of business, management, and resources; (v) with reasoned and strong management that has a proven track record of driving growth and profitability; and (vi) that will benefit from being publicly traded through access to broader source of capital and public profile. PNAC followed these initial set of criteria and guidelines outlined in the prospectus for its initial public offering to assess the value and the growth of the potential target but did not limit itself to those criteria.

Between May 17, 2022 through December 29, 2022, PNAC reviewed in varying degrees approximately five potential business combination candidates (including noco-noco) involved in various industries and sectors, including construction and infrastructure, manufacturing, high technology and fintech. PNAC's management team held frequent discussions regarding these targets both internally and with a wide range of the potential business combination candidates' management teams.

For the four potential candidates that PNAC did not proceed with the definitive transaction documents, PNAC signed non-disclosure agreement with Candidate One and Candidate Two, and non-binding term sheet with each of Candidate Three and Candidate Four. We summarize PNAC management's review and analysis process below:

**Candidate One:** On May 25, 2022, Candidate One, a Singapore incorporated company in the container business contacted Mr. Weixiong (Jeff) Cheong for potential business combination. Following the initial contact, Mr. Cheong became acquainted with the founder of Candidate One. Respectively on May 26 and May 27, 2022, founder and operational manager of Candidate One and Mr. Cheong had virtual meetings, during which the founder introduced the container industry and Candidate One's competitive advantages. On May 26, 2022, PNAC and Candidate One executed a non-disclosure agreement. Pursuant to the non-disclosure agreement, any non-public, confidential or proprietary information provided by disclosing party to the receiving party must be kept confidential. Both PNAC and Candidate One agreed not to use non-public, confidential or proprietary information received for any purpose except to evaluate, negotiate and/or possibly consummate a contemplated business combination. It also provides that, except as expressly permitted in such agreement or with the prior consent of the disclosing party, no one will disclose any non-public, confidential or proprietary disclosed to third parties except to the representatives of such third party who are required to have the information to carry out the discussions concerning the contemplated business combination, and such information must be kept confidential by such third parties. The non-disclosure agreement shall expire one year from the date thereof or may be terminated by any party at any time by written notice. However, each party's rights and obligations under such agreements will survive the expiration or termination of the agreement for a period of one year from the date of such expiration or termination, even after the return or destruction of confidential information by the receiving party. Following execution of the non-disclosure agreement, during the last week of May 2022, Mr. Cheong had several meetings with management team of Candidate One to understand Candidate One's business. Thereafter, Mr. Cheong and the board of PNAC held a virtual meeting with Candidate One to review Candidate One's business and discuss preparation of its audited financial statements. During that period, PNAC also conducted due diligence on Candidate One and its management team, including reviewing its business introduction deck and financial forecast. On June 7, 2022, PNAC and Candidate One executed a non-binding term sheet, which, among others, provides that the valuation of Candidate One is estimated at \$15 million to \$20 million. The term sheet did not contain exclusivity provision restricting PNAC's ability to search for other candidates. In August, Candidate One informed PNAC that it was no longer looking for opportunity to consummate a business combination with a SPAC.

**Candidate Two:** In May 2022, Candidate Two approached Mr. Dongfeng Wang. Candidate Two, based in California, is in data center and digital mining business. On May 31, 2022, Mr. Wang visited Candidate Two in its head office, and met with its management team. Following the visits, respectively on June 2 and June 3, 2022, Mr. Wang and management and consultants of Candidate Two held meetings to discuss the potential business combination, and Candidate Two's business, technology, and plan of listing. During the meeting, Mr. Wang also introduced PNAC and its criteria for potential acquisition target. On June 3, 2022, PNAC issued a due diligence questionnaire to Candidate Two. On June 4, 2022, PNAC and Candidate Two executed a non-disclosure agreement. Pursuant to the non-disclosure agreement, any non-public, confidential or proprietary information provided by disclosing party to the receiving party must be kept confidential. Both PNAC and Candidate Two agreed not to use non-public, confidential or proprietary information received for any purpose except to evaluate, negotiate and/or possibly consummate a contemplated business combination. It also provides that, except as expressly permitted in such agreement or with the prior consent of the disclosing party, no one will disclose any non-public, confidential or proprietary disclosed to third parties except to the representatives of such third party who are required to have the information to carry out the discussions concerning the contemplated business combination, and such information must be kept confidential by such third parties. The non-disclosure agreement shall expire one year from the date thereof or may be terminated by any party at any time by written notice. However, each party's rights and obligations under such agreements will survive the expiration or termination of the agreement for a period of one year from the date of such expiration or termination, even after the return or destruction of confidential information by the receiving party. On June 6, 2022, Candidate Two responded to the questionnaire and circulated its unaudited financials for the fiscal years 2021 and 2020, material contracts, shareholding structure, and industry report for PNAC's review. During May 30, 2022 to June 10, 2022, PNAC and Candidate Two worked actively on due diligence. On June 15, 2022, PNAC and Candidate Two signed a non-binding term sheet, which, among others, provides that PNAC and Candidate Two was contemplating a business combination with Candidate Two's valuation estimated at \$100 million. The term sheet did not contain exclusivity provision restricting PNAC's ability to search for other candidates. On June 15, 2022, PNAC held a board meeting. During the meeting, the PNAC management team introduced Candidate Two, including but not limited to information on the nature of its businesses, due diligence process, preliminary valuation, and management's analysis. PNAC management and board members also discussed the concerns and risks related to recent market condition in digital currency industry. In late June 2022, the management and PNAC Board decided not to proceed with a business combination with Candidate Two because the volatile condition in digital currency industry.

**Candidate Three:** On June 30, 2022, Mr. Weixiong (Jeff) Cheong, our Chief Operating Officer met with representative of Candidate Three and they expressed interests in a potential business combination with PNAC. Candidate Three is a leading contractor in construction and infrastructure industry in Singapore. On July 5, 2022, Mr. Cheong held a conference call with the representatives of Candidate Three to discuss the business of Candidate Three. During the call, representatives of Candidate Three gave a brief presentation on its business, and following the presentation, PNAC suggested entering into a non-disclosure agreement. On July 7, 2022, PNAC and Candidate Three executed a non-disclosure agreement. Pursuant to the non-disclosure agreement, any non-public, confidential or proprietary information provided by disclosing party to the receiving party must be kept confidential. Both PNAC and Candidate Three agreed not to use non-public, confidential or proprietary information received for any purpose except to evaluate, negotiate and/or possibly consummate a contemplated business combination. It also provides that, except as expressly permitted in such agreement or with the prior consent of the disclosing party, no one will disclose any non-public, confidential or proprietary disclosed to third parties except to the representatives of such third party who are required to have the information to carry out the discussions concerning the contemplated business combination, and such information must be kept confidential by such third parties. The non-disclosure agreement shall expire one year from the date thereof or may be terminated by any party at any time by written notice. However, each party's rights and obligations under such agreements will survive the expiration or termination of these agreement for a period of one year from the date of such expiration or termination, even after the return or destruction of confidential information by the receiving party. Following the execution of the non-disclosure agreement, on July 11, 2022, Candidate Three sent PNAC a business presentation deck, with information on its business model, and introduction on the industry. After the initial review, PNAC sent a follow-up request list to Candidate Three, requesting for additional information about Candidate Three's financial projection and other supporting documents, to which Candidate Three responded on July 13, 2022, with information and documents including material contracts and audit reports for fiscal years 2021 and 2020. On July 20, 2022, representative of Candidate Three and Mr. Cheong met in person in Singapore to discuss Candidate Three's business plan and financial performance. During July 20, 2022 to July 27, 2022, PNAC conducted research on Candidate Three's business, including relevant market research, comparing Candidate Three with its Singapore competitors, and research on valuation of benchmark companies. PNAC did not proceed with a business combination with Candidate Three because management believe that Candidate Three's business is relatively small compared to its competitors in the same markets and potential growth may be limited or uncertain.

**Candidate Four:** On July 8, 2022, Candidate Four was introduced by Mr. Dongfeng Wang. Candidate Four is a traditional bus manufacturer based in the U.S. and is undergoing a transition to a manufacturer of hydrogen fuel bus. On July 8, 2022, Mr. Wang met representatives of Candidate Four in person in Los Angeles. During the meeting, management of Candidate Four introduced its business and the industry, business plan, desired timeline of going public, financing need for consummating the transformation. Mr. Wang also introduced PNAC and its criteria for potential acquisition target. Following the meeting, the parties agreed to sign a non-disclosures agreement. On July 18, 2022, PNAC and Candidate Four executed a non-disclosure agreement. Pursuant to the non-disclosure agreement, any non-public, confidential or proprietary information provided by disclosing party to the receiving party must be kept confidential. Both PNAC and Candidate Four agreed not to use non-public, confidential or proprietary information received for any purpose except to evaluate, negotiate and/or possibly consummate a contemplated business combination. It also provides that, except as expressly permitted in such agreement or with the prior consent of the disclosing party, no one will disclose any non-public, confidential or proprietary disclosed to third parties except to the representatives of such third party who are required to have the information to carry out the discussions concerning the contemplated business combination, and such information must be kept confidential by such third parties. The non-disclosure agreement shall expire one year from the date thereof or may be terminated by any party at any time by written notice. However, each party's rights and obligations under such agreements will survive the expiration or termination of these agreement for a period of one year from the date of such expiration or termination, even after the return or destruction of confidential information by the receiving party. Following the execution of the non-disclosure agreement, on the same day, Candidate Four granted access of a virtual data room to PNAC, containing information and documents including but not limited to Candidate Four's corporate structure, management structure, principal shareholders, business operation, intellectual property, and licenses. On August 1, 2022, PNAC sent a list to Candidate Four with follow-up due diligence questions. On August 8, 2022, Candidate Four responded PNAC's requests with further due diligence materials, including financial statements for the past three fiscal years. On August 10, 2022, representative of Candidate Four and Mr. Wang had a virtual meeting to address PNAC's questions. The meeting was focused on discussion of Target Four's business plan implementation, research development, patent application, and financial performance. During August 10, 2022 to August 17, 2022, PNAC conducted research and discussed internally on Candidate Four's business, including research on the industry and analysis of Candidate Four's financial performance. PNAC management reviewed and considered all aspects of information of Candidate Four made available to them and decided not to pursue this candidate because of its historical financial performance as a traditional bus manufacturer and uncertainty in successfully executing its transformation plan into a hydrogen fuel bus manufacturer.

## ***Timeline of the Business Combination***

On June 1, 2022, Mr. Weixiong (Jeff) Cheong met with Singapore management team of noco-noco including Mr. Masataka Matsumura. Management of noco-noco shared introduction of noco-noco's business and the industry, and invited Mr. Cheong to visit 3DOM Alliance's facilities in Japan.

On June 9, Mr. Cheong travelled to Japan and had an on-site visit with 3DOM Alliance, the controlling shareholder of noco-noco, accompanied by management of noco-noco. During the visit, Mr. Cheong had conversations with noco-noco management team and 3DOM Alliance over topics including noco-noco's business operation, business plan analyses, and potential for business combination. To respond to questions in greater details, noco-noco management proposed a non-binding LOI with PNAC, in which there shall be confidentiality clause. Following Mr. Cheong's visit to Japan, PNAC management agreed to further pursue the opportunity with noco-noco.

On June 15, 2022, representatives of noco-noco and PNAC had meeting to discuss preliminarily on entering into a non-binding letter of intent.

On July 1, 2022, PNAC sent a draft non-binding term sheet to noco-noco which was primarily for the demonstration purpose to show the material terms to be included in the term sheet. The draft included, among others, the following terms: (i) the parties shall contemplate a business combination, and the deal structure will be determined based on due diligence findings and other considerations; and (ii) the total transaction consideration will be based on noco-noco's equity value estimated at \$2.5 billion. The valuation was proposed by PNAC and was based on the Selected Public Company Analysis conducted by PNAC, and in particular, the equity value of QuantumScape Corporation (NYSE: QS, "QuantumScape"), which was approximately \$2.5 billion on or around July 1, 2022. PNAC considered QuantumScape as the most comparable company to noco-noco. For details of PNAC's analysis performed on selected public company, see "*Selected Public Company Analysis*." The parties also agreed to further discuss valuation and other terms, once PNAC gains access to more information of noco-noco's business and operation.

On July 11, 2022, in order to obtain additional information of noco-noco and allow some time for the parties to negotiate substantive terms of a business combination, noco-noco and PNAC reached a non-binding letter of intent (the "noco-noco LOI") which contemplated the following major terms: (i) the noco-noco LOI is intended to express only a mutual indication of interest in a potential business combination and shall not create legal obligation to the parties, except for certain binding matters; (ii) the parties agree to discuss in good faith and make reasonable good faith efforts to agree in writing, non-binding, material terms of the potential business combination within 45 business days after date of the noco-noco LOI, and such agreement in writing shall be appended to and supplement the noco-noco LOI (the "Term Sheet"); (iii) noco-noco shall not, at any time, have any right, title, interest or claim of any kind in any monies in the Trust Account; (iv) each party shall keep confidential of information disclosed by the other party; and (v) until termination of the noco-noco LOI, noco-noco may not engage in transaction that would prohibit or impair the proposed business combination.

Following execution of the noco-noco LOI, noco-noco started sharing diligence materials to PNAC, including but not limited to documents in relation to business planning, and existing collaboration letters of intent or transaction indications.

From July 11, 2022 to August 5, 2022, noco-noco and PNAC had extensive discussions and negotiations over the proposed Term Sheet. The negotiation was mainly focused on valuation of noco-noco's business. PNAC conducted analysis of noco-noco's business and BEV industry in support of the valuation negotiation, including analysis performed on selected public company that PNAC deemed relevant. For details of PNAC's analysis performed on selected public company, see "*Selected Public Company Analysis*." noco-noco and PNAC later agreed on valuation range of \$1.25 billion to \$2.5 billion.

On August 5, 2022, the parties executed the Term Sheet. The Term Sheet included the following terms, among others: (i) the total transaction consideration will be based on noco-noco's equity value estimated at a range of \$1.35 billion to \$2.5 billion; and (ii) a transaction financing of at least \$20,000,000 will be consummated at the closing of the business combination.

On October 25, 2022, PNAC engaged Prime Number Capital LLC ("PNCPS") and WestPark Capital, Inc. ("WestPark"), the representatives of the underwriters for PNAC IPO, acted as the financial advisors to PNAC in connection with its initial business combination.

On October 25, 2022, PNAC and PNCPS entered into a separate engagement whereby PNCPS would, among others, use its reasonable efforts in identifying and introducing potential targets, valueate potential business combination and assess the proposed structure for business combination and assist in managing the process and other related services.

On October 27, 2022, noco-noco engaged Sidley Austin as its U.S. securities counsel to the proposed Business Combination.

On November 11, 2022, noco-noco engaged Marcum Asia CPAs LLP as its auditor in connection with the proposed Business Combination.

In November 2022, PNAC engaged Robinson & Cole LLP ("R&C") as its U.S. securities counsel to the proposed Business Combination.

On November 18, 2022, R&C sent a legal due diligence checklist to noco-noco as part of PNAC's diligence assessment of noco-noco's business operations.

On November 22, 2022, noco-noco entered into a license-in agreement with 3DOM Alliance, pursuant to which noco-noco was granted the exclusive license on certain patents and other pending patent applications from 3DOM Alliance (the "Renewed License-in Agreement"). noco-noco relies on such exclusive license-in agreement with 3DOM Alliance to utilize 3DOM Alliance's intellectual property and technologies to develop and manufacture its own battery products and services. The Renewed License-in Agreement was a renewal of a license-in agreement between noco-noco and 3DOM Alliance effective as of August 18, 2021 (as amended on August 29, 2022 and terminated on November 22, 2022) (the "Original License-in Agreement"). The terms of the Renewed License-in Agreement were nearly identical to the Original License-in Agreement which went effective before PNAC's initial contact with noco-noco. PNAC was not involved in the negotiations of the terms of the Renewed License-in Agreement, but was notified of the renewal and the importance of the agreement, including the upfront payment of the \$30 million licensing fee, and had taken it into consideration when evaluating noco-noco as potential target (including in reaching the final evaluation of \$1.35 billion). PNAC and noco-noco agreed that the source of funds to be used for payment of \$30 million licensing fee shall come from any remaining cash in Trust Account after closing, transaction financing, and potential future financing after the closing. noco-noco also conveyed that they would work with 3DOM Alliance on deferral of payment or adjustment of payment schedule to ensure noco-noco has adequate capital resources for its daily operation post closing. PNAC and its representatives were also granted access to the Renewed License-in Agreement so was able to evaluate the agreement from legal and commercial perspectives. After independent assessment and discussions with noco-noco on the source of funds to be used for payment of \$30 million licensing fee, PNAC considered the effect of payment on noco-noco's liquidity and capital resources post closing to be relatively minimal.

On November 23, 2022, R&C and PNAC received noco-noco's initial response to the due diligence checklists that contained legal diligence materials regarding noco-noco. PNAC and R&C commenced its diligence on these materials.

On November 28, 2022, representatives of noco-noco and PNAC, including Sidley Austin and R&C, held a virtual meeting to discuss the proposed transaction structure, and established the timeline and responsibilities for the transaction moving forward.

On November 30, 2022, Sidley Austin and R&C exchanged emails to determine the drafting responsibilities for this proxy statement/prospectus.

On December 1, 2022, R&C sent follow-up due diligence request relating to the diligence materials drafted in non-English and translation thereof.



On December 5 and 6, 2022, representatives of noco-noco circulated to the translated due diligence materials to R&C.

On December 6, 2022, Sidley Austin sent an initial draft of the Business Combination to R&C, which reflected the terms in the executed Term Sheet.

On December 7, 2022, Sidley Austin circulated drafting responsibilities for this proxy statement/prospectus based on previous discussions.

On December 7, 2022, R&C circulated an updated due diligence request list with additional due diligence questions.

On December 8, 2022, representatives of noco-noco provided the additional requested due diligence materials via emails.

On December 10, 2022, R&C sent follow-up due diligence questions to representatives of noco-noco and the representatives of noco-noco addressed these questions by emails and additional due diligence materials on the same day.

The Business Combination Agreement was negotiated between December 6, 2022 subsequent to the initial circulation of the draft Business Combination Agreement through the date of execution on December 29, 2022. PNAC and noco-noco agreed to set the final valuation in the lower end of the valuation range, at \$1.35 billion, given consideration of the following factors:

- *Performance of Comparable Public Company:* PNAC considers QuantumScape to be the most comparable public company to noco-noco and had given much weight to QuantumScape's equity value when deciding noco-noco's valuation. The equity value of QuantumScape declined significantly following its NYSE debut, from \$8 billion in April 2021 to \$2.5 billion in July 2022, which was attributable to increased competition in the BEV industry and concerns over QuantumScape's production capabilities. As a company in its early stage of development and has not started significant production, noco-noco is likely to be exposed to similar challenges and risks as QuantumScape.
- *Market Conditions:* In reaching the \$1.35 billion valuation for noco-noco, PNAC factored in overall capital market conditions and stock performance of companies that consummated business combinations recently, as well as the need to attract potential investors and retain non-redeeming Public Stockholder of PNAC.
- *Financial risks :* As the medium to long-term financial success for noco-noco relies on the market launch of the X-SEPA Separators, continuation or expansion of its existing partnership arrangements (including by reaching binding contractual agreements with such partners), robust management of its marketing and sales expenses and cash flows, and development of a track record and reputation in the markets, there are significant uncertainty and risks for its short-term financial health and success. In addition to the overall market downturns, public market investors have shown significant hostility on development stage technology companies, who lacks significant track record of positive cash flows and sales success. PNAC therefore finds it necessary to seek downward departure in its valuation.
- *Information from Business and Financial Due Diligence:* (i) Research on the markets of battery and BEV industry, carbon abatement solutions, and carbon credit sales industry; (ii) Review of noco-noco's strategy on expanding market for X-SEPA Separators; (iii) Analysis and review of noco-noco's historical financial statements; and (iv) Analysis and review of noco-noco's MOUs and potential transactions.

Specific provisions in the Business Combination Agreement and related agreements were negotiated by emails and virtual conference calls between respective counsels for noco-noco and PNAC throughout the period shortly after the initial circulation of the draft Business Combination Agreement and the date of the execution of the Business Combination Agreement. In addition to negotiations on final valuation, as discussed above, substantive negotiations centered around the following points:

- *Transaction Structure:* noco-noco and PNAC considered consummating the transaction through alternative structures which could be more straightforward, such as direct merge of PNAC or a wholly-owned subsidiary of PNAC with noco-noco, while as parties proceed with due diligence and negotiations, certain considerations emerged so that parties reached consensus on the final structure of merger plus share exchange as provided in the Business Combination Agreement. Among others, noco-noco and PNAC and each of their representatives considered: (i) noco-noco conducts its business and operation entirely outside of the U.S., accordingly it is beneficial for the combined entity to retain status as a foreign private issuer; and (ii) a direct merger of PNAC with noco-noco, a Singapore-incorporated entity, may significantly increase Singapore tax exposure for noco-noco.
- *Available PNAC Cash:* As a closing condition, PNAC proposed that the Available PNAC Cash shall be \$20,000,000, while noco-noco hoped it could be raised to \$50,000,000. PNAC refused to accept the change given consideration of the redemption risk that a significant number of PNAC's stockholders may elect to redeem their shares prior to the consummation of the Business Combination which could leave little to no cash in the Trust Account, thus increasing the risk of PNAC not being able to consummate a Business Combination in time. In exchange for retaining Available PNAC Cash at \$20,000,000, PNAC agreed that more flexibility shall be given to valuation negotiation, that the negotiation shall be fixed to the range of \$1.25 billion to \$2.5 billion as agreed in Term Sheet. PNAC Cash is eventually set at \$20,000,000 immediately prior to or upon the Share Exchange Closing.
- *Earn -Out Structure:* PNAC originally proposed that an earn-out structure for merger consideration, given the uncertainty associated with noco-noco's future profitability. While noco-noco proposed removal of such terms from Business Combination Agreement as a preferred payment schedule. After extensive communications, PNAC agreed with the removal of the earn-out structure, on the condition that the valuation is fixed to the lower end of the \$1.25 billion to \$2.5 billion range.
- *Corporate Governance:* PNAC had discussions with noco-noco on the size of the PubCo board of directors, and the appointment power of PNAC and noco-noco of directors to the PubCo board. Taking into account the Nasdaq listing standards and noco-noco's preferences of seeking Foreign Private Issuer exemption, PNAC agreed that the board size should remain at seven, with two independent directors to be appointed, as provided in the Term Sheet. In exchange for the downward departure in the valuation, PNAC would forego its preference to have the power to appoint at least one director to the board. PNAC and noco-noco also communicated regarding the principal terms of the post-transaction employment of PubCo's executive officers and the compensation of directors and executive officers, including a share incentive plan to be adopted upon the closing of the business combination. For details of such agreed terms, see "*Management of PubCo Following the Business Combination—Employment Agreements and Indemnification Agreement*", "*—Compensation of Directors and Executive Officers*", and "*—Share Incentive Plan*".
- *Shareholder Rights:* PNAC and noco-noco initially had diverging view on the parameters of the Lock-up Agreement as applied to the noco-noco shareholders, and the registration rights priority of PNAC Stockholders, noco-noco shareholders and any potential investors who participate in the Transaction Financing. The parties had various conference call with the presence and advice of counsel of each side to discuss the issues. With explanations of PNAC's counsel on the regulatory requirements and the market norms of lock-up and registration rights arrangements, noco-noco agreed to defer to PNAC to set forth the terms and conditions of the Lock-up Agreement and Registration Rights Agreement. noco-noco's representatives also agree to convey the requirements and market norms to 3DOM Alliance and other shareholders.
- *Other Provisions:* In general, PNAC proposed terms in Business Combination Agreement with reference to terms of recently disclosed de-SPAC transactions where the target company has business operation in Asia, including the proposed business combination of TradeUp Acquisition Corp. (Nasdaq: PNAC) and Estrella Biopharma, Inc., and proposed business combination of Thunder Bridge Capital Partners IV Inc. (Nasdaq: THCP) and Coincheck, Inc.

Drafts of the Business Combination Agreement were exchanged by emails between respective counsels for noco-noco and PNAC on or about December 15, 21, 24, 2022. Key topics of negotiation included, but were not limited to, the structure and terms of the business combination as contemplated in the Business Combination Agreement, the scope of the representations and warranties, the applicable closing conditions and pre-closing covenants, termination terms and conditions, corporate governance matters relating to, among others, post-closing management, board composition and equity incentive plan, and disclosure schedules of each party.

During the negotiation period, PNAC and noco-noco also continued with discussion over noco-noco's valuation.

On December 21, 2022, Merger Sub was incorporated under the laws of the State of Delaware.

On December 22, 2022, PNAC engaged Ogier Global as its Cayman counsel in connection with the Business Combination.

On December 27, 2022, Sidley Austin circulated draft disclosure letter of noco-noco to PNAC and R&C.

On December 27, 2022, Sidley Austin circulated draft Lock-Up Agreement to PNAC and R&C.

On December 28, 2022, R&C circulated draft disclosure letter of PNAC to noco-noco and Sidley Austin, and Sidley Austin circulated updated draft disclosure letter of noco-noco to PNAC and R&C on December 28, 2022.

Between December 28, 2022 through the date of execution on December 29, 2022, respective counsels for noco-noco and PNAC exchanged drafts and comments to the disclosure letters.

On December 28, 2022, R&C circulated draft Warrant Assumption Agreement and Registration Rights Agreement to noco-noco and Sidley Austin, and the parties exchanged comments on the same day.

On December 28, 2022, the PubCo was incorporated under the laws of the Cayman Islands as an exempted company limited by shares.

During the drafting and review process, directed by management of PNAC, R&C sent a draft of the Business Combination, each related ancillary document, and a summary of transaction terms to the Board for their review and consideration. The Board was regularly updated with any additional changes until the parties finalized the Business Combination and each Ancillary Document.

Between November 23, 2022 through the date of signing of the Business Combination Agreement on December 29, 2022, noco-noco, PNAC, Sidley Austin, and R&C continuously reviewed diligence materials and followed up with additional diligence requests.

On December 29, 2022, a meeting of the Board was called to discuss and approve the Business Combination Agreement, each related agreement to be entered into prior to or concurrently with the closing of the Business Combination, and the Business Combination. After considering the proposed terms of the Business Combination Agreement, each related agreements to be entered into prior to or concurrently with the closing of the Business Combination, and taking into account the other factors described below under the caption "*The Board's Reasons for the Approval of the Business Combination*," the Board unanimously approved the Business Combination Agreement, each related agreements to be entered into prior to or concurrently with the closing of the Business Combination, and the Business Combination, and determined that it was advisable and in the best interests of PNAC to consummate the Business Combination contemplated by the Business Combination Agreement and related agreements. The Board directed that the Business Combination Proposal and the other proposals described in this proxy statement/prospectus be submitted to PNAC's stockholders for approval and adoption, and recommended that PNAC's stockholders approve and adopt the Business Combination Proposal and the other Proposals.

Later, on December 29, 2022, PNAC, Merger Sub, noco-noco and certain shareholders of noco-noco entered into the Business Combination Agreement.

On December 30, 2022, PNAC filed a Current Report on Form 8-K with a summary of certain key terms of the Business Combination Agreement and other ancillary agreements.

On January 25, 2023, the New SubCo was incorporated under the laws of Singapore.

On February 3, 2023, each of the PubCo and the New SubCo passed board resolutions approving, confirming, ratifying and authorizing the execution of the Business Combination Agreement and the transactions contemplated thereby and became parties to the Business Combination Agreement in accordance with the terms thereof.

## PNAC Board's Reasons for the Approval of the Business Combination

PNAC was organized for the purpose of entering into a merger, capital stock exchange, asset acquisition, stock purchase, reorganization, or similar business combination with one or more businesses.

The Business Combination resulted from a thorough search for a potential target, utilizing PNAC's resources along with the investment and operation experience of PNAC management and the Board. The terms of the Business Combination are the result of extensive negotiations between PNAC and noco-noco.

From the date of PNAC IPO through the execution of the Business Combination on December 29, 2022, PNAC evaluated various potential target companies. PNAC followed the initial set of criteria and guidelines outlined in the prospectus for the initial public offering to assess the value and the growth of the potential target but did not limit itself to those criteria. PNAC's management evaluated business combination opportunities made available to them based on the merits of a particular initial business combination which may be based, to the extent relevant, on these general guidelines as well as other considerations, factors, and criteria that they deemed relevant.

Prior to reaching the decision to approve the Business Combination Agreement, the PNAC Board reviewed the results of the business and financial due diligence conducted by PNAC management and third party legal and financial advisors, which included:

1. Extensive meetings with noco-noco's management.
2. Research on the markets of battery and BEV industry, and carbon abatement solutions and carbon credit sales industry, including historical growth trends and market share information as well as growth financial projections and Selected Public Company Analysis.
3. Review of noco-noco's strategy on expanding market for X-SEPA Separators.
4. Analysis and review of noco-noco's historical financial statements.
5. Analysis and review of noco-noco's MOUs and potential transactions.
6. Review of noco-noco's business model including its planned future operations and underlying technology.
7. Interviews with senior executives from various business departments of noco-noco.
8. Multiple rounds of discussions with the principal shareholder, the CEO and the senior management of noco-noco on future growth strategy.
11. Review of noco-noco's constitutional documents, material business contracts and licenses.
12. Review of noco-noco's related party transactions.
13. Review of prevailing industry changes and challenges in the COVID-19 era.
14. Legal due diligence review conducted by PNAC's legal counsel.
15. Assessment of noco-noco's total addressable market, its key competitors, competitive advantages, barriers of entry, and target market share.
16. Assessment of noco-noco's public company readiness.
17. Assessment of the Renewed License-in Agreement and the upfront payment of the \$30 million licensing fee therein.

PNAC indicated its intention to acquire a company that it believes possesses attractive long-term growth potential, has been well-positioned within its industry, and would benefit from the broad network and strategic, financial, and operational experience of PNAC's leadership team. In particular, PNAC Board considered the following positive factors, although not weighted or in any order of significance:

- **Cutting-edge Technologies.** noco-noco license in a series of cutting-edge patents and technologies from 3DOM Alliance, its controlling shareholder, with respect to, among others, battery cascade use, battery management system, battery cell and pack model, and battery units. The cutting-edge technologies enable noco-noco to produce batteries that, as compared to conventional batteries, have a longer lifespan and higher reliability, and are more resistant to high operating temperature and thermal runaways. noco-noco's unique position with 3DOM Alliance as the exclusive licensee of its patents and technologies allows it to take full advantage of the technology advancement that 3DOM Alliance may develop or license in through various cooperation and collaboration with leading universities and professors for our battery products.
- **Unique Own-and-Lease Business Model.** noco-noco operates a unique own-and-lease business model where it manufacture, through OEMs, battery products, including batteries, BEVs and ESS, and lease them to clients, primarily consisting of commercial transportation companies, renewable energy plants and other power plants requiring grid stabilization and backup power in Asia. Traditionally, it would cost tremendous upfront capital expenditure and operation expenses for companies to purchase the battery products. However, under own-and-lease business model, clients only need to lease battery products without having to purchase them, enabling clients' operation of BEVs and renewable energy plants more affordable.
- **Multiple avenues for growth.** noco-noco assists its clients, primarily landowners of forests, mangrove, bushland or land of similar kinds, to reduce their carbon emissions or absorb carbon, and earn carbon credits generated from the carbon abatement projects. In addition, leveraging its carbon credits generation capability, noco-noco is able to cross-sell the carbon credits generated through carbon abatement projects to its battery product clients, who are keen to reduce their carbon emissions generated during their operations. In particular, with the carbon credit generation capability, noco-noco is able to provide leasing services and carbon credit sales in a bundle, on the one hand, helping battery product clients to offset the carbon emissions generated by their operations, and on the other hand, improving clients' stickiness and generating additional profits. The synergies between the two business segments earn noco-noco both preference by clients and strategic cooperation opportunities.
- **Visionary Management and Synergy with 3DOM Alliance.** noco-noco is led and influenced by a visionary CEO, Mr. Masataka Matsumura, who is deeply rooted in the battery industry. Mr. Matsumura's deep business insights have driven the sustainable development of our strategic business direction. His strategic vision and thorough understanding of the battery industry helps us make crucial business decisions based on market trends and development. Since noco-noco's inception, noco-noco has received strong support from, and achieved great synergy with, its controlling shareholder, 3DOM Alliance. 3DOM Alliance is a forerunner in the R&D of battery technologies, including battery separators and lithium-ion batteries.

- **Due diligence.** Due diligence examinations of noco-noco and discussions with noco-noco's management team have led PNAC to conclude that noco-noco has assembled the elements to create the foundation for a successful company going forward. In particular, PNAC reviewed the license-in arrangement between noco-noco and 3DOM Alliance and considered source of funds to be used for payment of \$30 million licensing fee. PNAC Board concluded that the effect of payment on noco-noco's liquidity and capital resources post closing would be relatively minimal and does not significantly change PNAC Board's overall assessment of the Business Combination, given the Transaction Financing and potential future financings after closing of the Business Combination.

- **Potential for profitability.** According to the assessment of in-license rights of noco-noco and its strategic alliances with various third parties, and the financial projections provided by noco-noco, the PNAC Board considered that noco-noco (i) has a potential of scaling the business in a capital efficient manner; and (ii) has a potential to generate revenue sufficient to achieve profitability sustainably upon commercialization of noco-noco's own-and-lease business model and our carbon abatement solution business.

- **Other alternatives.** The PNAC Board believes that after a thorough review of other business combination opportunities reasonably available to PNAC, the Business Combination represents the best potential business combination for PNAC and its stockholders, based upon the process utilized to evaluate and assess other potential acquisition targets, and the PNAC Board believes that such process has not presented a better alternative.

The Board also identified and considered the following factors and risks as weighing negatively against pursuing the Business Combination (although not weighted or in any order of significance):

- *Macroeconomic Risks.* Macroeconomic uncertainty, including the potential impact of the COVID-19 pandemic, and the effects it could have on noco-noco's business operation post-closing;
- *Redemption Risk.* The potential that a significant number of PNAC's stockholders elect to redeem their shares prior to the consummation of the Business Combination which in turn leaving little to no cash left in the trust account for working capital purposes;
- *Shareholder Vote.* The risk that PNAC's stockholders may fail to provide the respective votes necessary to approve the Business Combination;
- *Closing Conditions.* The fact that the completion of the Business Combination is conditioned on the satisfaction of certain closing conditions that are not or may not be within PNAC's control;
- *Litigation.* The possibility of litigation challenging the Business Combination or that an adverse judgment granting permanent injunctive relief could indefinitely enjoin consummation of the Business Combination;
- *Listing Risks.* The challenges associated with preparing noco-noco, a private entity, for the applicable disclosure and listing requirements to which PubCo will be subject as a publicly traded company on Nasdaq upon the closing of the Business Combination;
- *Benefits May Not Be Achieved.* The risks that the potential benefits of the Business Combination may not be fully achieved or may not be achieved within the expected timeframe;
- *Projections May Not Be Achieved.* The risks that noco-noco would not attain the milestones set forth in their financial projections;
- *Liquidation of PNAC.* The risks and costs to PNAC if the Business Combination is not completed, including the risk of diverting management focus and resources from other business combination opportunities, which could result in PNAC being unable to effect a business combination by the Outside Date and exceeding its lifespan;
- *Growth Initiatives May Not be Achieved.* The risk that noco-noco's growth initiatives may not be fully achieved or may not be achieved within the expected timeframe;
- *Board and Independent Committees.* The risk that PubCo's board of directors post-Closing and independent committees might not possess adequate skills set within the context of PubCo's operations as a public company;
- *No Third-Party Valuation.* The risk that PNAC did not obtain a third-party valuation in connection with the Business Combination;
- *PNAC's Stockholders Receiving a Minority Position in PubCo.* The risk from PNAC's stockholders owning a minority position in PubCo as of the Closing;
- *Fees and Expenses.* The fees and expenses associated with completing the Business Combination; and
- *Other Risk Factors.* Various other risk factors associated with the business of noco-noco, as described in the section entitled "Risk Factors" appearing elsewhere in this proxy statement/prospectus.

The above discussion of the material factors considered by the PNAC Board is not intended to be exhaustive but does set forth the principal factors considered by the PNAC Board.

After considering the foregoing factors, the Board concluded, in its business judgment, that the potentially positive reasons for the Business Combination outweighed the potentially negative reasons. In connection with its deliberations, the Board also considered that PNAC's executive officers and directors may have financial interests in the Business Combination that may be different from, or in addition to, the interests of PNAC stockholders. The Board was aware of and considered these interests, among other matters, in reaching the determination that the Business Combination was advisable and in the best interests of PNAC and its stockholders. See "*The Business Combination Proposal—Interests of the Founders and PNAC's Directors and Officers in the Business Combination.*"

The preceding discussion of the information and factors considered by the Board is not intended to be exhaustive but includes the material factors considered by the Board. In view of the complexity and wide variety of factors considered by the Board in connection with its evaluation of the Business Combination, the Board did not consider it practical to, nor did it attempt to, quantify, rank or otherwise assign relative weights to the different factors that it considered in reaching its decision. In addition, in considering the factors described above, individual members of the Board may have given different weight to different factors. The Board considered this information as a whole and overall considered the information and factors to be favorable to, and in support of, its determinations and recommendations.

This explanation of the Board's reasons for its approval of the Business Combination, and all other information presented in this section, is forward-looking in nature and, therefore, should be read in light of the factors discussed under the section entitled "*Forward-Looking Statements.*"

#### ***Certain Projected Information of noco-noco***

Noco-noco does not, as a matter of course, publicly disclose long-term forecasts or internal projections of its future performance, revenue, earnings, financial condition or other results. However, in connection with PNAC's due diligence and consideration of the potential Business Combination with noco-noco, in July 2022, noco-noco management provided PNAC with internally prepared financial forecasts for year ending December 31, 2023 to 2032 (the "**Projections**"). The Projections were provided to PNAC only for use as a component in its overall evaluation of noco-noco and should not be viewed as public guidance. The summary information from the Projections is included in the table below because such information was considered by PNAC for purposes of evaluating the Business Combination. Inclusion of summary information regarding the financial forecasts in this proxy statement/prospectus is not intended to influence your decision whether to vote for the Proposals.

Noco-noco's management relied on numerous assumptions to derive the Projections described below, including, among others, assumptions regarding (a) increasing demand for EV and battery leasing; (b) appropriate pricing of leasing rates; (c) estimation of the various related costs of operating the leasing business; (d) increasing demand and prices for carbon credits; (e) ability to monetize its smart battery infrastructure into a new revenue stream of selling data services in the latter years. Based on assumptions described herein and footnoted to the projection table, noco-noco's management estimated the numbers of units of EVs, EV batteries and ESS batteries that we anticipated to be leased out and an estimated monthly leasing rate in each year in the period from 2023 to 2032 in order to deliver the projected revenues. Based on estimated leasing units, management estimated the purchase cost of each unit, given effect of, among others, capital expenses and depreciation over a certain expected lifespan of the EV, EV battery or ESS battery, and computed net income by deducting from the projected revenue various costs, including CAPEX depreciation, maintenance costs and insurance costs. Depreciation was computed by allocating the purchase cost using a straight-line method, over the expected lifespan of the EVs or batteries.

The Projections are subject to inherent uncertainty since they are based on assumptions about events that may occur in the future, many of which are beyond PNAC's and noco-noco's control. As noco-noco had not generated substantial revenue when the Projections were rendered or as of the date hereof, noco-noco was unable to compare the Projections with historical operating results. Noco-noco however believes that the projected revenues are reasonable and the growth rates are sustainable for the ten-year projections, because it factored in (i) the early commercialization stage of noco-noco; (ii) existing MOUs and collaboration that noco-noco had achieved and would achieve in the next one or two years; (iii) conservatively low target numbers in the first few years relative to the estimated size of the global market during the same period; (iv) in the case of operating results beyond 2025 until 2032, a relatively faster growth rate compared to its growth rate in 2023 and 2024, reflecting the potential market expansion and penetration it would have achieved in 2023 and 2024, as well as the increasing establishment of its battery technological edge within the industry, enabling it to compete effectively with industry competitors; (v) continuing conservatism from 2025 to 2032 as far as share of estimated global market was concerned. For instance, according to Frost & Sullivan, although there will be 21.4 million E2W units leased out in 2023, noco-noco projected the number of its leased E2W unit in 2023 would be a conservative 500 units, representing 0.023% of the global E2W market. Similarly, according to Frost & Sullivan, there will be 26.8 million units of E4W leased out in 2025, and noco-noco projected only 6,000 units leased out during the same period, representing 0.0224% of the global E4W industry projected by Frost & Sullivan. Over the longer period, in 2032, noco-noco projects the number of E4W units being leased out rising to 801,900, representing a market share of 0.891% of the global E4W industry of 90 million units, according to Frost & Sullivan.

Notwithstanding the foregoing, projections are subject to increased uncertainty and risk that they will not be achieved. For instance, noco-noco may encounter unforeseen technical or non-technical challenges in actual operations which may affect the projected growth rate. The execution capability of the noco-noco management team to expand noco-noco from an early-stage company to reach wider market is also a factor that will affect the ability to achieve the projected revenue. The ability of noco-noco's manufacture team to ensure prompt fulfilment of the demand for batteries and EVs is another factor that may have an impact on actual revenue. None of the Projections should be regarded as a representation by any person that the results contained in the prospective financial information will be achieved.

The Projections were not prepared with a view toward public disclosure, nor were they prepared with a view toward complying with published guidelines of the SEC, the guidelines established by the American Institute of Certified Public Accountants or IFRS for the preparation and presentation of prospective financial information, but, in the view of noco-noco's management, were prepared on a reasonable basis. However, this information is not fact and should not be relied upon as being necessarily indicative of future results, and readers of this document are cautioned not to place undue reliance on the prospective financial information. The Projections do not take into account any circumstances or events occurring after the date it was prepared. PubCo will not refer back to this unaudited prospective financial information in future periodic reports filed under the Exchange Act.

There can be no assurance that the Projections will be realized or that actual results will not be significantly higher or lower than projected. These Projections are subjective in many respects and thus are susceptible to multiple interpretations and periodic revisions based on actual experience and business developments.

No independent auditors have audited, reviewed, examined, compiled nor applied agreed-upon procedures with respect to the accompanying Projections and, accordingly, none of PNAC, Marcum Asia CPAs LLP, PNAC's independent registered public accounting firm, and UHY LLP, noco-noco's independent registered public accounting firm, express an opinion or any other form of assurance with respect thereto or its achievability, and assume no responsibility for, and disclaim any association with, the prospective financial information. The audit reports included in this proxy statement/prospectus relate to historical financial information. They do not extend to the prospective financial information and should not be read to do so.

EXCEPT TO THE EXTENT REQUIRED BY APPLICABLE FEDERAL SECURITIES LAWS, NEITHER NOCO-NOCO NOR PNAC INTENDS TO MAKE PUBLICLY AVAILABLE ANY UPDATE OR OTHER REVISION TO THE FINANCIAL PROJECTIONS. THE FINANCIAL PROJECTIONS DO NOT TAKE INTO ACCOUNT ANY CIRCUMSTANCES OR EVENTS OCCURRING AFTER THE DATE THAT INFORMATION WAS PREPARED. READERS OF THIS PROXY STATEMENT/PROSPECTUS ARE CAUTIONED NOT TO PLACE UNDUE RELIANCE ON THE UNAUDITED FINANCIAL PROJECTIONS SET FORTH BELOW AND NOT TO RELY ON SUCH FINANCIAL INFORMATION IN MAKING A DECISION REGARDING THE BUSINESS COMBINATION PROPOSAL, AS SUCH FINANCIAL INFORMATION MAY BE MATERIALLY DIFFERENT THAN ACTUAL RESULTS. NONE OF NOCO-NOCO, PNAC, NOR ANY OF THEIR RESPECTIVE AFFILIATES, OFFICERS, DIRECTORS, ADVISORS OR OTHER REPRESENTATIVES HAS MADE OR MAKES ANY REPRESENTATION TO ANY NOCO-NOCO SHAREHOLDER, PNAC SHAREHOLDER OR ANY OTHER PERSON REGARDING ULTIMATE PERFORMANCE COMPARED TO THE INFORMATION CONTAINED IN THE FINANCIAL PROJECTIONS OR THAT FINANCIAL AND OPERATING RESULTS WILL BE ACHIEVED. PUBCO DOES NOT INTEND TO REFERENCE THESE FINANCIAL PROJECTIONS IN ITS FUTURE PERIODIC REPORTS FILED UNDER THE EXCHANGE ACT.





Certain of the measures included in the Projections are non-GAAP financial measures, including Adjusted EBITDA and Adjusted Net Income. Non-GAAP financial measures should not be considered in isolation from, or as a substitute for, financial information presented in compliance with US GAAP, and non-GAAP financial measures as used by noco-noco are not reported by all of its competitors and may not be comparable to similarly titled amounts used by other companies.

A summary of the financial forecast information regarding noco-noco's anticipated future operations for year ending December 31, 2023 to 2032 is set forth below.

**The key elements of the Projections are summarized as follows:**

(\$ in millions)

Income Statement	2023	2024	2025	2026	2027	2028	2029	2030	2031	2032
ESS Sales	14	-	-	-	-	-	-	-	-	-
Carbon-free EV Leasing	28	84	212	493	1,327	4,214	9,852	18,426	31,506	51,510
Carbon-free ESS Leasing	33	65	102	198	562	2,266	6,309	13,993	28,599	49,522
Carbon credit revenue	80	126	275	451	632	1,114	745	490	-	-
IOT	-	-	2	14	74	314	1,274	4,154	12,794	30,074
<b>Total Revenue</b>	<b>155</b>	<b>274</b>	<b>591</b>	<b>1,156</b>	<b>2,596</b>	<b>7,908</b>	<b>18,181</b>	<b>37,063</b>	<b>72,899</b>	<b>131,107</b>
ESS - Cost of Sales	12	-	-	-	-	-	-	-	-	-
Battery Maintenance	4	9	15	29	78	233	598	1,298	2,696	4,872
Maintenance Cost	1	4	10	21	57	155	349	646	1,101	1,799
Telematics cost	4	11	25	56	152	425	991	1,930	3,576	6,263
Insurance cost	4	10	19	41	109	311	748	1,512	2,899	5,047
Carbon credit cost	60	101	221	392	717	1,560	2,262	3,455	5,633	9,997
<b>Total Cost of Sales/Services</b>	<b>87</b>	<b>135</b>	<b>290</b>	<b>539</b>	<b>1,113</b>	<b>2,685</b>	<b>4,948</b>	<b>8,842</b>	<b>15,904</b>	<b>27,977</b>
<b>Gross Margin</b>	<b>68</b>	<b>139</b>	<b>302</b>	<b>617</b>	<b>1,483</b>	<b>5,223</b>	<b>13,232</b>	<b>28,221</b>	<b>56,995</b>	<b>103,130</b>
Marketing cost	8	5	8	12	13	16	36	48	73	131
License fee	6	8	19	42	119	546	1,523	3,346	6,865	12,412
R&D cost	8	14	30	58	130	395	909	1,853	3,645	6,555
Salary	6	30	90	150	375	525	563	638	713	825
Other SGA	8	14	30	58	130	395	909	1,853	3,645	6,555
<b>EBITDA</b>	<b>33</b>	<b>68</b>	<b>126</b>	<b>298</b>	<b>716</b>	<b>3,346</b>	<b>9,292</b>	<b>20,483</b>	<b>42,054</b>	<b>76,652</b>

**Notes and Assumptions:**

In connection with the preparation of the Projections, noco-noco's management considered various material assumptions, including but not limited to:

- There would be four streams of revenue beginning in 2023 – ESS sales, ESS leasing, EV leasing and carbon credit generation and sales. ESS sales would be phased out in 2024 as noco-noco intends to focus solely on leasing ESS instead of selling ESS. EV leasing would include 2/3-wheeler vehicles and 4-wheeler trucks/vans.
- Carbon credit generation and sales would form the single biggest revenue contributor from 2023 (51% of total revenue) to 2025 (46%), after which EV leasing would take over as the largest revenue earner starting in 2025 (43%).
- A new revenue stream, IoT (installed in the noco-noco batteries) would kickoff in 2025 with a small revenue of \$2 million but increase to \$30,074 million by the year 2032, contributing a substantial 23% of total revenue.
- EBITDA margin would range between 21% to 58% over the 10-year period from 2023 to 2032.
- Carbon credit prices are assumed to be \$25/ton in 2023, and would increase progressively over the years to \$91/ton in 2032. Carbon credit units being sold are projected based on available credits from current contracted projects, and credits from potential new projects that noco-noco expects to be initiated soon.
- By 2032, the number of 2/3-wheeler vehicles leased out would be 1,050,596 and the number of trucks leased out will be 801,900.
- By 2032, the quantity/capacity of ESS leased out would be 115.7Gwh.

In light of the fact that noco-noco is an early stage company with a history of financial losses, that its battery business expects to incur significant expenses and continuing losses for the foreseeable future, and other material assumptions in connection with preparation of the Projections as referenced above, the PNAC Board did not rely upon the Projections for approving the Business Combination, and considered many factors in addition to the Projections in recommending the Business Combination. Stockholders of PNAC are strongly cautioned not to place undue reliance, if any, on these Projections, and not to rely on the Projections in making any decision regarding the Business Combination. For a more comprehensive analysis of PNAC Board's reasons for approving the Business Combination, see "PNAC Board's Reasons for Approving the Business Combination."

**Selected Public Company Analysis**

PNAC reviewed and analyzed selected historical and projected information of noco-noco and compared this information to certain historical and projected financial information of four publicly traded companies that PNAC deemed to be reasonably comparable to noco-noco (each a "Comparable Company" and collectively, the "Comparable Companies"). The criteria for selecting the Comparable Companies were mainly industry, size, stage of development, target market, and future profitability. PNAC reviewed, among other things, enterprise values of the Comparable Companies, calculated as equity values based on closing stock prices on July 1, 2022, and such other financial data and information for these Comparable Companies as of July 1, 2022.

	ENTERPRISE VALUE USD million	PS			REV USD million			PE		
		FY2021	FY2022E	FY2023	FY2021	FY2022E	FY2023	FY2021	FY2022	FY2023
		Contemporary Amperex Technology Co., Limited (SHE: 300750)	178,212.8	9.6x	4.6x	3.4x	18,979.8	39,315.6	52,857.3	72.5x
Enovix Corporation (NASDAQ: ENVX)	968.8	-	165.3x	18.6x	0.0	8.3	73.7	-	-	-
QuantumScape Corporation (NYSE: QS)	2,485.3	-	-	3,349.2x	0.0	0.0	1.1	-	-	-
Solid Power, Inc. (NASDAQ: SLDP)	414.3	353.7x	210.8x	199.8x	2.7	4.6	4.8	53.0x	-	-
Mean	181.6x	126.9x	892.8x	4,745.6	9,832.1	13,234.2	62.8x	57.7x	37.4x	
Median	181.6x	165.3x	109.2x	1.4	6.4	39.2	62.8x	57.7x	37.4x	

Source: CapitalIQ; as of July 1, 2022.

PNAC estimated a range of enterprise values of noco-noco using QuantumScape as the most comparable company to noco-noco, given their similar industry, size, stage of development, target market, and future profitability. The equity value of QuantumScape declined significantly following its NYSE debut, from \$8 billion in April 2021 to \$2.5 billion in July 2022, which was attributable to increased competition in the BEV industry and concerns over QuantumScape's production capabilities. As a company in its early stage of development and has not started significant production, noco-noco is likely to be exposed to similar challenges and risks as QuantumScape. In addition, as detailed in "— *Timeline of the Business Combination*", a variety of factors arising during the negotiation further resulted in a downward departure in noco-noco's valuation.

### Interests of PNAC's Directors and Officers in the Business Combination

When considering the PNAC Board's recommendation to vote in favor of approving the Business Combination Proposal and the Governing Documents Proposal, PNAC stockholders should keep in mind that the PNAC Initial Stockholders, have interests in such proposals that are different from, or in addition to (and which may conflict with), those of PNAC stockholders generally. These interests include, among other things, the interests listed below:

- the beneficial ownership by the Sponsors of an aggregate of 1,474,000 Founder Shares and 398,892 Private Shares, which would become worthless if PNAC does not complete a business combination within the applicable time period, as the Sponsor has waived any right to redemption with respect to these shares. The Sponsors paid an aggregate of approximately \$25,000, or \$0.017 per share, for the Founders Shares and \$3,988,920, or \$10.00 per share, for the Private Shares. Such shares of PNAC Class A Common Stock held by the Sponsors have an aggregate market value of approximately \$ , based on the closing price of PNAC Class A Common Stock on the Record Date, resulting in a theoretical gain of \$ (or \$ per share);
- Mr. Dongfeng Wang, PNAC'S Chairman and Chief Executive Officer, is the manager of Prime Number Acquisition LLC, a Sponsor of PNAC, and as such may be deemed to have sole voting and investment discretion with respect to the shares of PNAC Class A Common Stock held by Prime Number Acquisition LLC, including 1,383,700 Founder Shares and 349,032 Private Shares as described above. In addition, Mr. Wang directly holds 45,000 Founder Shares, which would become worthless if PNAC does not complete a business combination within the applicable time period, as Mr. Wang has waived any right to redemption with respect to these shares. For the shares directly held by Mr. Wang, Mr. Wang paid an aggregate of approximately \$652,174, or \$0.017 per share, for the Founders Shares. Such shares of PNAC Class A Common Stock directly held by Mr. Wang have an aggregate market value of approximately \$ , based on the closing price of PNAC Class A Common Stock on the Record Date, resulting in a theoretical gain of \$ (or \$ per share). Such shares of PNAC Class A Common Stock held by Prime Number Acquisition LLC have an aggregate market value of approximately \$ , based on the closing price of PNAC Class A Common Stock on the Record Date, resulting in a theoretical gain of \$ (or \$ per share);
- Mr. David Friedman, PNAC'S Chief Financial Officer and director, directly holds 30,000 Founder Shares, which would become worthless if PNAC does not complete a business combination within the applicable time period, as Mr. Friedman has waived any right to redemption with respect to these shares. For the shares directly held by Mr. Friedman, Mr. Friedman paid an aggregate of approximately \$434,783, or \$0.017 per share, for the Founders Shares. Such shares of PNAC Class A Common Stock directly held by Mr. Friedman have an aggregate market value of approximately \$ , based on the closing price of PNAC Class A Common Stock on the Record Date, resulting in a theoretical gain of \$ (or \$ per share);
- Mr. Weixong (Jeff) Cheong, PNAC'S Chief Operating Officer, is the sole director and member of DBG Global Limited. DBG Global Limited is a member of Prime Number Acquisition LLC, a Sponsor of PNAC, and Mr. Cheong, as the sole director and member of DBG Global Limited, may be deemed to have beneficial ownership over 447,561 shares of PNAC Class A Common Stock for which Prime Number Acquisition LLC is the record holder, including 336,565 Founder Shares and 110,996 Private Shares. Such shares of PNAC Class A Common Stock would become worthless if PNAC does not complete a business combination within the applicable time period, as Prime Number Acquisition LLC has waived any right to redemption with respect to these shares. Such shares of PNAC Class A Common Stock held by Prime Number Acquisition LLC have an aggregate market value of approximately \$ , based on the closing price of PNAC Class A Common Stock on the Record Date, resulting in a theoretical gain of \$ (or \$ per share);
- each of the three independent directors of PNAC holds 15,000 Founder Shares, which would become worthless if PNAC does not complete a business combination within the applicable time period, as the independent directors have waived any right to redemption with respect to these shares. Each independent director of PNAC paid approximately \$217,391, or \$0.017 per share for such 15,000 Founder Shares. Such 15,000 Founder Shares held by each independent director have an aggregate market value of approximately \$ , based on the closing price of PNAC Class A Common Stock on the Record Date, resulting in a theoretical gain of \$ (or \$ per share);
- in order to finance transaction costs in connection with an intended initial business combination, the Sponsors, affiliates of the Sponsors, PNAC's directors and officers, may, but are not obligated to, loan PNAC funds as may be required. Additionally, if we extend the time available to us to complete our business combination, our Sponsors, their affiliates or designee may deposit \$645,000, for each three-month extension for up to two times to extend the time for us to complete our business combination. If PNAC completes the Business Combination, PNAC would repay such loaned amounts out of the proceeds of the Trust Account released to PNAC. Otherwise, such loans would be repaid only out of funds held outside the Trust Account. In the event that the Business Combination does not close, PNAC may use a portion of the working capital held outside the Trust Account to repay such loaned amounts but no proceeds from the Trust Account would be used to repay such loaned amounts. Up to \$3,000,000 of such loans may be convertible into the Working Capital Shares, at a price of \$10.00 per share at the option of the lender. As of the date hereof, PNAC had no outstanding balance under the working capital loans as evidenced by the Notes accordingly. In the event that PNAC fails to complete a business combination by May 16, 2023 (or November 16, 2023, if extended), it is uncertain if PNAC has sufficient working capital held outside the Trust Account to fully repay any outstanding loans, and the Sponsors may be eventually held liable for PNAC's liabilities pursuant to its certain indemnification obligations;

- the fact that the PNAC Initial Stockholders (including the Sponsors, certain PNAC officers and directors) have agreed not to redeem any PNAC Founder Shares and PNAC Private Shares held by them in connection with a shareholder vote to approve the proposed Business Combination;
- the fact that given the very low purchase price (of \$25,000 in aggregate) that the PNAC Initial Stockholders paid for the PNAC Founder Shares as compared to the price of the PNAC Common Stock sold in PNAC IPO, the PNAC Initial Stockholders may earn a positive rate of return on their investment even if the PubCo Ordinary Shares trade below the price initially paid for the PNAC Common Stock in the PNAC IPO and the PNAC Public Stockholder may experience a negative rate of return following the completion of the Business Combination;
- the fact that the PNAC Initial Stockholders have agreed to waive their rights to liquidating distributions from the Trust Account with respect to any PNAC Founder Shares and PNAC Private Shares held by them if PNAC fails to complete an initial business combination by the Final Redemption Date. As a result of waiving liquidating distributions, if PNAC fails to complete an initial business combination by the Final Redemption Date, the Sponsors would lose \$3,988,920 for the purchase of PNAC Private Shares, and the PNAC Initial Stockholders would lose \$25,000 for the purchase of the PNAC Founder Shares, and thus they (other than the PNAC Initial Stockholders that acquired the PNAC Founder Shares for nominal consideration) would incur substantial loss of investment and will not be reimbursed for any out-of-pocket expenses;

- the fact that the PNAC Initial Stockholders may be incentivized to complete the Business Combination, or an alternative initial business combination with a less favorable company or on terms less favorable to stockholders, rather than to liquidate, in which case the PNAC Initial Stockholders would lose their entire investment. As a result, the PNAC Initial Stockholders may have a conflict of interest in determining whether noco-noco is an appropriate business with which to effectuate a business combination and/or in evaluating the terms of the Business Combination;
- the fact that pursuant to the Registration Rights Agreement, the PNAC Initial Stockholders can demand that PubCo register its registrable securities under certain circumstances and will also have piggyback registration rights for these securities in connection with certain registrations of securities that PubCo undertakes;
- the continued indemnification of PNAC's directors and officers and the continuation of PNAC's directors' and officers' liability insurance after the Business Combination (i.e. a "tail policy");
- the fact that if the Trust Account is liquidated, including in the event PNAC is unable to complete an initial business combination by the Final Redemption Date, the Sponsors have agreed to indemnify PNAC to ensure that the proceeds in the Trust Account are not reduced below \$10.20 per public share, or such lesser per public share amount as is in the Trust Account on the liquidation date, by the claims of prospective target businesses with which PNAC has entered into a letter of intent, confidentiality or other similar agreement or a business combination agreement or claims of any third party for services rendered or products sold to PNAC, but only if such a vendor or target business has not executed a waiver of any and all rights to seek access to the Trust Account; and
- the fact that the PNAC Initial Stockholders, are, or may in the future become, affiliated with entities that are engaged in a similar business to PNAC. The PNAC Initial Stockholders are not prohibited from sponsoring, or otherwise becoming involved with, any other blank check companies prior to completing the Business Combination. Accordingly, if any of PNAC's officers or directors becomes aware of a business combination opportunity that is suitable for an entity to which he or she has then current fiduciary or contractual obligations, he or she will honor his or her fiduciary or contractual obligations to present such Business Combination opportunity to such entity, subject to their fiduciary duties under DGCL. In addition, to the fullest extent permitted by applicable laws, the Existing PNAC Charter waives certain applications of the doctrine of corporate opportunity in some circumstances where the application of any such doctrine would conflict with any fiduciary duties or contractual obligations they may have as of the date of the Existing PNAC Charter or in the future, and PNAC will renounce any expectancy that any of the directors or officers of PNAC will offer any such corporate opportunity of which he or she may become aware to PNAC. PNAC does not believe that the pre-existing fiduciary duties or contractual obligations of its officers and directors materially impacted its search for an acquisition target. Further, PNAC does not believe that the waiver of the application of the corporate opportunity doctrine in the Existing PNAC Charter had any impact on its search for a potential business combination target.

The PNAC Initial Stockholders have agreed to, among other things, vote all of their PNAC Founder Shares and PNAC Private Shares in favor of the proposals being presented at the Special Meeting and waive their redemption rights with respect to their PNAC Common Stock in connection with the consummation of the Business Combination. As of the date of this proxy statement/prospectus, the PNAC Initial Stockholders own approximately 29.05% of the issued and outstanding shares of PNAC Common Stock.

At any time at or before the Business Combination, during a period when they are not then aware of any material nonpublic information regarding PNAC or its securities, the Sponsors, noco-noco, and/or PNAC's or noco-noco's directors, officers, advisors or respective affiliates may purchase PNAC Public Shares from institutional and other investors who vote, or indicate an intention to vote, against the Business Combination Proposal or the Governing Documents Proposal, or execute agreements to purchase such shares from such investors in the future, or they may enter into transactions with such investors and others to provide them with incentives to acquire PNAC Public Shares or vote their PNAC Public Shares in favor of the Business Combination Proposal or the Governing Documents Proposal. Such a purchase may include a contractual acknowledgement that such shareholder, although still the record or beneficial holder of PNAC Common Stock, is no longer the beneficial owner thereof and therefore agrees not to exercise its redemption rights.

If the Sponsors, noco-noco, and/or PNAC's or noco-noco's directors, officers, advisors, or respective affiliates purchase shares in privately negotiated transactions from PNAC Public Stockholders who have already elected to exercise their redemption rights, then such selling shareholder would be required to revoke their prior elections to redeem their shares. The Sponsors, noco-noco, and/or PNAC's or noco-noco's directors, officers, advisors or respective affiliates may also purchase PNAC Public Shares from institutional and other investors who indicate an intention to redeem PNAC Common Stock, or, if the price per share of PNAC Common Stock falls below \$10.00 per share, then such parties may seek to enforce their redemption rights. The above-described activity could be especially prevalent in and around the time of Closing. The purpose of such share purchases and other transactions would be to (a) increase the likelihood that: (i) the Business Combination Proposal is approved by the affirmative vote of the holders of a majority of the issued and outstanding shares of PNAC Common Stock entitled to vote, who attend, in person or by proxy, and vote thereupon at the Special Meeting; (ii) the Governing Documents Proposal is approved by the affirmative vote of at least two-thirds of the issued and outstanding shares of PNAC Common Stock entitled to vote, who attend, in person or by proxy, and vote thereupon at the Special Meeting; and (iii) PubCo's net tangible assets (as determined in accordance with Rule 3a51-1(g)(1) of the Exchange Act) being at least \$5,000,001 after giving effect to the transactions contemplated by the Business Combination Agreement and the Transaction Financing; and (b) otherwise limit the number of PNAC Public Shares electing to redeem. The Sponsors, noco-noco and/or PNAC's or noco-noco's directors, officers, advisors, or respective affiliates may also purchase shares from institutional and other investors for investment purposes.

Entering into any such arrangements may have a depressive effect on the PNAC Common Stock. For example, as a result of these arrangements, an investor or holder may have the ability to effectively purchase shares at a lower-than-market price and may therefore be more likely to sell the shares he, she, or they own, either at or before the Business Combination.

If such transactions are executed, then the Business Combination could be completed in circumstances where such consummation could not have otherwise occurred. Share purchases by the persons described above would allow them to exert more influence over approving the proposals to be presented at the Special Meeting and would likely increase the chances that such proposals would be approved.

As of the date of this proxy/prospectus, the Sponsors, PNAC's directors, officers and advisors, and their affiliates, have not made any purchases of shares and/or warrants from investors, or have agreed to any agreements or transactions with any investors or others to provide such investors or others with incentives to acquire PNAC Public Shares or vote in favor of the Business Combination Proposal or Governing Documents Proposal. If the Sponsors or their affiliates enter into any such purchases, agreements or transactions:

- any such purchases of securities would be made at a price no higher than the redemption price;
- shares acquired in such transactions (i) would not be voted in favor of approving the Business Combination and (ii) holders of such shares would waive their right to redemption rights with respect to such shares; and

PNAC will disclose in a Current Report on Form 8-K prior to the Special Meeting the following information: (i) the amount of securities purchased in such transaction(s), along with the purchase price; (ii) the purpose of such purchases; (iii) the impact, if any, of the purchases on the likelihood that the Business Combination will be approved; (iv) the identities of security holders who sold such shares (if not purchased on the open market) or the nature of security holders (e.g. 5% security holders) who sold such shares; and (v) the number of securities for which PNAC has received redemption requests pursuant to its redemption offer.

The existence of financial and personal interests of one or more of PNAC's directors results in conflicts of interest on the part of such director(s) between what he, she, or they may believe is in the best interests of PNAC and what he, she, or they may believe is best for himself, herself, or themselves in determining to recommend that shareholders vote for the proposals. In addition, PNAC's officers have interests in the Business Combination that may conflict with your interests as a shareholder.

In addition to the above, please see "*Risk Factors—Risks Related to PNAC and the Business Combination*" and "*Information Related to PNAC—Conflicts of Interest*" for additional information on interests of PNAC's directors and officers.

## Certain Engagements in Connection with the Business Combination and Related Transactions

On October 25, 2022, PNAC engaged Prime Number Capital LLC (“PNCPS”) and WestPark Capital, Inc. (“WestPark”), the representatives of the underwriters for PNAC IPO, acted as the financial advisors to PNAC in connection with its initial business combination. Pursuant to their engagement letter, PNCPS and WestPark have agreed, if requested by and in consultation with PNAC, among others, to assist PNAC in the transaction structuring and negotiation of a definitive purchase agreement with respect to a business combination, hold meetings with PNAC stockholders to discuss business combination and the target’s attributes, introduce PNAC to potential investors in connection with a business combination, assist PNAC with relevant financial analysis, presentations, press releases. PNCPS and WestPark will not receive any additional compensation for services rendered under this engagement except the deferred underwriting fee in the amount of \$2,257,500 as provided in a certain underwriting agreement dated May 12, 2022 among PNAC, PNCPS and WestPark, with each of PNCPS and WestPark receiving \$1,128,750 in deferred underwriting fee. PNAC also agrees to reimburse PNCPS and WestPark up to \$20,000 for its reasonable out-of-pocket expenses in connection with the performance of their services thereunder.

On October 25, 2022, PNAC and PNCPS entered into a separate engagement whereby PNCPS would, among others, use its reasonable efforts in identifying and introducing potential targets, value potential business combination and assess the proposed structure for business combination and assist in managing the process and other related services. In exchange for its services, PNAC has agreed to pay or cause the surviving entity to pay a service fee equal to 0.5% of the total value of all cash, securities, or other property paid or transferred at the closing by or to PNAC, the target and/or their shareholders with respect to a business combination. On January 31, 2023, PNAC and PNCPS amended the original engagement to set forth PNCPS’s compensation thereunder in connection with the initial business combination, which includes \$500,000 in cash and 609,756 newly issued PubCo Ordinary Shares, payable at the Closing. In addition, PNAC also agrees to reimburse PNCPS up to \$5,000 for its reasonable out-of-pocket expenses in rendering their services.

In the aggregate, excluding any out-of-pocket expense reimbursements, PNCPS and WestPark shall receive a total of \$2,757,500 in fees and 609,756 PubCo Ordinary Shares in stock, including a total of \$1,628,750 in fees and 609,756 PubCo Ordinary Shares in stock to PNCPS, and a total of \$1,128,750 in fees to WestPark, contingent and payable upon the consummation of the Business Combination. In considering the recommendation of PNAC Board to vote in favor of approval of the Business Combination Proposal, the Governing Documents Proposal, and the Adjournment Proposal, PNAC stockholders should keep in mind that PNCPS, WestPark and entities affiliated with these advisors have interests in such proposals that are different from, or in addition to (and which may conflict with), those of PNAC stockholders generally, including those discussed above.

In addition, on April 30, 2023, PNAC entered into a Placement Agent Agreement with PNCPS, pursuant to which PNCPS shall act as the placement agent for the solicitation and placement of securities of PNAC, in exchange for a placement fee of 7% of the aggregate gross proceeds received by PNAC from the sales of such securities.

PNCPS and WestPark have not sent, and do not anticipate sending, any notice about ceasing involvement with the Business Combination. In addition, neither has waived the deferred underwriting fee from PNAC’s IPO.

## Anticipated Accounting Treatment

The Business Combination is made up of the series of transactions provided for in the Business Combination Agreement as described elsewhere within this proxy statement/prospectus. The Business Combination will be accounted for as a capital reorganization. Under this method of accounting, PubCo will be treated as the acquired company for financial reporting purposes. Accordingly, the Business Combination will be treated as the equivalent of noco-noco issuing shares at the Closing for the net assets of PNAC as of the Closing Date, accompanied by a recapitalization. The net assets of PNAC will be stated at historical cost, with no goodwill or other intangible assets recorded and operations prior to the Business Combination will be those of noco-noco. noco-noco has been determined to be the accounting acquiror for purposes of the Business Combination based on an evaluation of the following facts and circumstances. Notwithstanding the legal form, the Business Combination will be accounted for as a reverse recapitalization in accordance with GAAP:

- noco-noco’s operations prior to the Business Combination will comprise the ongoing operations of PubCo;
- noco-noco’s existing senior management team will comprise all or majority of the senior management team of PubCo; and
- noco-noco’s shareholders, or the Sellers, are expected to have a majority of the voting power of PubCo.

## Regulatory Matters

The Business Combination Agreement and the transactions contemplated by the Business Combination Agreement are not subject to a closing condition that any additional federal, state or foreign regulatory requirement or approval be obtained, except for filings with the registrar of the Cayman Islands necessary to effectuate the transactions contemplated by the Business Combination Agreement and filings with ACRA in connection with the Business Combination.

## No Appraisal or Dissenters’ Rights

No holders who hold PNAC units, PNAC Common Stock, PNAC Warrants or PNAC Rights have appraisal or dissenters’ rights in connection with the Business Combination under the DGCL. Therefore, no dissenters’ rights will be available under the Merger in respect of the PNAC securities; however, PNAC Public Stockholders have a redemption right with respect to their PNAC Public Shares as further described in this proxy statement/prospectus. See “*Special Meeting of PNAC stockholders—Redemption Rights*” for a detailed description of the procedures to be followed if you wish to redeem your PNAC Public Shares for cash.

## Votes Required for Approval

The approval of the Business Combination Proposal requires the affirmative vote of the holders of a majority of the shares of PNAC Common Stock cast by those stockholders of PNAC who, being entitled to do so, attend, in person or by proxy, and vote thereupon at the Special Meeting.

The approval of the Business Combination Proposal is a condition to the consummation of the Business Combination Transactions. If the Business Combination Proposal is not approved, the other proposals (except the Adjournment Proposal, as described below) shall not be presented to the PNAC stockholders for a vote.

An abstention or broker non-vote will be counted towards the quorum requirement but will not count as a vote cast at the Special Meeting.

## Recommendation of PNAC Board of Directors

**THE PNAC BOARD OF DIRECTORS UNANIMOUSLY RECOMMENDS THAT THE PNAC STOCKHOLDERS VOTE “FOR” THE APPROVAL OF THE BUSINESS COMBINATION PROPOSAL.**

The existence of financial and personal interests of one or more of PNAC’s directors results in conflicts of interest on the part of such director(s) between what he, she or they may believe is in the best interests of PNAC and its shareholders and what he, she or they may believe is best for himself, herself or themselves in determining to

recommend that shareholders vote for the proposals. In addition, PNAC's officers have interests in the Business Combination that may conflict with your interests as a shareholder. See the section entitled "*The Business Combination Proposal—Interests of PNAC's Directors and Executive Officers in the Business Combination*" for a further discussion of these considerations.

## THE GOVERNING DOCUMENTS PROPOSAL

### General

As a condition precedent to the Share Exchange Closing, the Existing PNAC Charter will effectively be replaced by the Amended PubCo Charter given that holders of PNAC Common Stock will, effective as of the consummation of the Merger Closing (and assuming such holders do not redeem their shares of PNAC Common Stock) hold PubCo Ordinary Shares subject to the Amended PubCo Charter.

PNAC stockholders are asked to consider and vote upon and to approve by the affirmative vote of four separate proposals (collectively, the “Governing Documents Proposal”) in connection with the replacement of the Existing PNAC Charter with the Amended PubCo Charter. Each of the Business Combination Proposal and the Governing Documents Proposal are cross-conditioned on the approval of each other. If any one of these proposals is not approved by PNAC stockholders, the Business Combination shall not be consummated.

The Amended PubCo Charter differ materially from the Existing PNAC Charter. The following table sets forth a summary of the material changes proposed between the Existing PNAC Charter and the Amended PubCo Charter that are included in the Governing Documents Proposal. This summary is qualified by reference to the complete text of the Amended PubCo Charter, attached to this proxy statement/prospectus as Annex B. PNAC stockholders are encouraged to read the Amended PubCo Charter in their entirety for a more complete description of their terms.

Additionally, we encourage shareholders to carefully review the information set out under the “Comparison of Corporate Governance and Shareholder Rights” section of this proxy statement/prospectus.

#### Authorized Share Capital (Governing Documents Proposal A)

##### PNAC

PNAC is authorized to issue 20,500,000 shares, consisting of (a) 20,100,000 shares of PNAC Common Stock, including (i) 20,000,000 shares of PNAC Class A Common Stock, and (ii) 100,000 shares of PNAC Class B Common Stock, and (b) 400,000 shares of PNAC preferred stock (the “PNAC Preferred Stock”).

##### PubCo

PubCo’s authorized share capital is \$50,000 divided into 500,000,000 PubCo Ordinary Shares of a par value of \$0.0001 each.

#### Share Structure (Governing Documents Proposal B)

##### PNAC

PNAC has a multi-class share structure comprising PNAC Class A Common Stock, PNAC Class B Common Stock and PNAC Preferred Stock.

##### PubCo

PubCo has a single-class share structure comprising PubCo Ordinary Shares.

#### Director Appointment (Governing Documents Proposal C)

##### PNAC

PNAC can have its directors elected by a plurality of the votes cast by the stockholders present in person or represented by proxy at the meeting and entitled to vote thereon, subject to the rights of the holders of Preferred Stock to vote separately by class or series to elect one or more directors. The board of PNAC is classified into three classes (as nearly equal in number as possible) with only one class of directors being elected in each year and each class (except for those directors appointed prior to PNAC’s first annual meeting of stockholders) serving a three-year term. The number of directors of PNAC, other than those who may be elected by the holders of one or more series of the Preferred Stock voting separately by class or series, shall be fixed from time to time exclusively by the board of PNAC pursuant to a resolution adopted by a majority of the directors.

##### PubCo

PubCo can appoint directors by Ordinary Resolution (as defined in the Amended PubCo Charter) or by the Directors. PubCo does not have a classified board. Unless re-appointed or removed pursuant to the Amended PubCo Charter, each Director of PubCo will be appointed for a term expiring at the next following annual general meeting of the PubCo. The total number of Directors of PubCo shall be at least three and the maximum number of Directors shall be unlimited, but the PubCo can increase or reduce the limits on the number of Directors by Ordinary Resolution (as defined in the Amended PubCo Charter).



**Other Provisions including Status as a Blank Check  
Company (Governing Documents Proposal D)**

**PNAC**

---

The Existing PNAC Charter include various provisions related to PNAC's status as a blank check company prior to the consummation of a business combination.

**PubCo**

---

The Amended PubCo Charter do not include provisions related to PubCo's status as a blank check company, as these will not be applicable to PubCo upon consummation of the Business Combination.

**Resolutions to be Voted Upon**

The full text of each of the resolutions to be proposed in respect of the four separate proposals within the Governing Documents Proposal is as follows:

“RESOLVED that, upon the Merger Effective Time (as defined in the Certificate of Merger), the effective change in authorized share capital from (i) the authorized share capital of PNAC immediately prior to the Merger Effective Time (as defined in the Certificate of Merger) of 20,500,000 shares, consisting of (a) 20,100,000 shares of PNAC Common Stock, including (i) 20,000,000 shares of PNAC Class A Common Stock, and (ii) 100,000 shares of PNAC Class B Common Stock, and (b) 400,000 shares of PNAC Preferred Stock, to (ii) the authorized share capital of PubCo of \$50,000 divided into 500,000,000 PubCo Ordinary Shares of a par value of \$0.0001 each, be approved and authorized;

RESOLVED that, upon the Merger Effective Time (as defined in the Certificate of Merger) the effective change in the share capital structure from (i) a multi- class share structure of PNAC immediately prior to the Merger Effective Time (as defined in the Certificate of Merger), comprising PNAC Class A Common Stock, PNAC Class B Common Stock and PNAC Preferred Stock, to (ii) a single-class share structure of PubCo, comprising solely PubCo Ordinary Shares, which change will be effected given that holders of the PNAC Common Stock will, effective as of the Merger Closing (and assuming such holders do not redeem their shares of PNAC Common Stock), hold PubCo Ordinary Shares, be approved and authorized;

RESOLVED that, upon the Merger Effective Time (as defined in the Certificate of Merger) the effective change in director appointment from (i) (a) election of directors by a plurality of the votes cast by the stockholders present in person or represented by proxy at the meeting and entitled to vote thereon, subject to the rights of the holders of Preferred Stock to vote separately by class or series to elect one or more directors, (b) a board classified into three classes (as nearly equal in number as possible) with only one class of directors being elected in each year and each class (except for those directors appointed prior to PNAC's first annual meeting of stockholders) serving a three-year term, and (c) the number of directors of PNAC, other than those who may be elected by the holders of one or more series of the Preferred Stock voting separately by class or series, being fixed from time to time exclusively by the board of PNAC pursuant to a resolution adopted by a majority of the directors, to (ii) (a) election of Directors by Ordinary Resolution (as defined in the Amended PubCo Charter) or by the Directors, (b) a non-classified board with each Director serving a term expiring at the next following annual general meeting of the PubCo unless re-appointed or removed pursuant to the Amended PubCo Charter, and (c) the total number of Directors of PubCo being at least three and the maximum number of Directors being unlimited, subject to PubCo's increase or reduction of the limits on the number of Directors by Ordinary Resolution (as defined in the Amended PubCo Charter), be approved and authorized; and

RESOLVED that, upon the Merger Effective Time (as defined in the Certificate of Merger) all other changes arising from or in connection with the effective substitution of PNAC's certificate of incorporation and bylaws in effect immediately prior to the Merger Effective Time (as defined in the Certificate of Merger) by the Amended PubCo Charter as the governing documents applicable to the holders of PubCo Ordinary Shares, including the removal of certain provisions relating to PNAC's status as a blank check company that will not be applicable following consummation of the Business Combination, be approved and authorized.”

**THE GOVERNING DOCUMENTS PROPOSAL A  
(AUTHORIZED SHARE CAPITAL)**

**Overview**

**Governing Documents Proposal A**—to approve in all respects that upon the Merger Effective Time (as defined in the Certificate of Merger), the effective change in authorized share capital from (i) the authorized share capital of PNAC immediately prior to the Merger Effective Time (as defined in the Certificate of Merger) of 20,500,000 shares, consisting of (a) 20,100,000 shares of PNAC Common Stock, including (i) 20,000,000 shares of PNAC Class A Common Stock, and (ii) 100,000 shares of PNAC Class B Common Stock, and (b) 400,000 shares of PNAC Preferred Stock, to (ii) the authorized share capital of PubCo of \$50,000 divided into 500,000,000 PubCo Ordinary Shares of a par value of \$0.0001 each.

Assuming the Business Combination Proposal is approved, PNAC stockholders are also being asked to approve Governing Documents Proposal A, which is, in the judgment of PNAC’s board of directors, necessary to adequately address the needs of PubCo after the Business Combination.

If Governing Documents Proposal A is approved, the authorized share capital will be effectively changed as set forth above.

This summary is qualified by reference to the complete text of the Amended PubCo Charter, copies of which are attached to this proxy statement/prospectus as Annex B. All PNAC stockholders are encouraged to read the Amended PubCo Charter in their entirety for a more complete description of their terms.

**Reasons for the Change**

The purpose of this proposal is to provide for an authorized share capital structure of PubCo that will enable it to have available for issuance a number of authorized shares of ordinary shares sufficient to support its growth and to provide flexibility for future corporate needs.

**Votes Required for Approval**

The approval of the Governing Documents Proposal A will require the affirmative votes of the holders of a majority of the issued and outstanding shares of PNAC Common Stock entitled to vote, who attend, in person or by proxy, and vote thereupon at the Special Meeting.

An abstention or broker non-vote will be counted towards the quorum requirement but will not count as a vote cast at the Special Meeting.

**Recommendation of PNAC Board of Directors**

**THE PNAC BOARD OF DIRECTORS UNANIMOUSLY RECOMMENDS THAT THE PNAC STOCKHOLDERS VOTE “FOR” THE APPROVAL OF THE GOVERNING DOCUMENTS PROPOSAL A.**

The existence of financial and personal interests of one or more of PNAC’s directors results in conflicts of interest on the part of such director(s) between what he, she or they may believe is in the best interests of PNAC and its shareholders and what he, she or they may believe is best for himself, herself or themselves in determining to recommend that shareholders vote for the proposals. In addition, PNAC’s officers have interests in the Business Combination that may conflict with your interests as a shareholder. See the section entitled “*The Business Combination Proposal—Interests of PNAC’s Directors and Executive Officers in the Business Combination*” for a further discussion of these considerations.

**THE GOVERNING DOCUMENTS PROPOSAL B  
(SHARE STRUCTURE)**

**Overview**

**Governing Documents Proposal B**—to approve in all respects the effective change in the share capital structure from (i) a multi-class share structure of PNAC immediately prior to the Merger Effective Time (as defined in the Certificate of Merger), comprising PNAC Class A Common Stock, PNAC Class B Common Stock and PNAC Preferred Stock, to (ii) a single-class share structure of PubCo, comprising solely PubCo Ordinary Shares, which change will be effected given that holders of the PNAC Common Stock will, effective as of the Merger Closing (and assuming such holders do not redeem their shares of PNAC Common Stock), hold PubCo Ordinary Shares.

Assuming the Business Combination Proposal is approved, PNAC stockholders are also being asked to approve Governing Documents Proposal B, which is, in the judgment of PNAC Board, necessary to adequately address the needs of PubCo after the Business Combination.

If Governing Documents Proposal B is approved, the share structure will be effectively changed as set forth above.

This summary is qualified by reference to the complete text of the Amended PubCo Charter, copies of which are attached to this proxy statement/prospectus as Annex B. All PNAC stockholders are encouraged to read the Amended PubCo Charter in their entirety for a more complete description of their terms.

**Reasons for the Change**

The purpose of this proposal is to provide for a share structure of PubCo that will enable holders of PubCo Ordinary Shares to have equal voting power to the number of shares held in PubCo.

**Votes Required for Approval**

The approval of the Governing Documents Proposal B will require the affirmative votes of the holders of at least a majority of the issued and outstanding shares of PNAC Common Stock entitled to vote, who attend, in person or by proxy, and vote thereupon at the Special Meeting.

An abstention or broker non-vote will be counted towards the quorum requirement but will not count as a vote cast at the Special Meeting.

**Recommendation of PNAC Board of Directors**

**THE PNAC BOARD OF DIRECTORS UNANIMOUSLY RECOMMENDS THAT THE PNAC STOCKHOLDERS VOTE “FOR” THE APPROVAL OF THE GOVERNING DOCUMENTS PROPOSAL B.**

The existence of financial and personal interests of one or more of PNAC’s directors results in conflicts of interest on the part of such director(s) between what he, she or they may believe is in the best interests of PNAC and its shareholders and what he, she or they may believe is best for himself, herself or themselves in determining to recommend that shareholders vote for the proposals. In addition, PNAC’s officers have interests in the Business Combination that may conflict with your interests as a shareholder. See the section entitled “*The Business Combination Proposal—Interests of PNAC’s Directors and Executive Officers in the Business Combination*” for a further discussion of these considerations.

**THE GOVERNING DOCUMENTS PROPOSAL C  
(DIRECTOR APPOINTMENT)**

**Overview**

**Governing Documents Proposal C**—to approve in all respects the effective change in director appointment from (i) (a) election of directors by a plurality of the votes cast by the stockholders present in person or represented by proxy at the meeting and entitled to vote thereon, subject to the rights of the holders of Preferred Stock to vote separately by class or series to elect one or more directors, (b) a board classified into three classes (as nearly equal in number as possible) with only one class of directors being elected in each year and each class (except for those directors appointed prior to PNAC’s first annual meeting of stockholders) serving a three-year term, and (c) the number of directors of PNAC, other than those who may be elected by the holders of one or more series of the Preferred Stock voting separately by class or series, being fixed from time to time exclusively by the board of PNAC pursuant to a resolution adopted by a majority of the directors, to (ii) (a) election of Directors by Ordinary Resolution (as defined in the Amended PubCo Charter) or by the Directors, (b) a non-classified board with each Director serving a term expiring at the next following annual general meeting of the PubCo unless re-appointed or removed pursuant to the Amended PubCo Charter, and (c) the total number of Directors of PubCo being at least three and the maximum number of Directors being unlimited, subject to PubCo’s increase or reduction of the limits on the number of Directors by Ordinary Resolution (as defined in the Amended PubCo Charter).

Assuming the Business Combination Proposal is approved, PNAC stockholders are also being asked to approve Governing Documents Proposal C, which is, in the judgment of PNAC Board, necessary to adequately address the needs of PubCo after the Business Combination.

If Governing Documents Proposal C is approved, the director appointment rights will be effectively changed as set forth above.

This summary is qualified by reference to the complete text of the Amended PubCo Charter, copies of which are attached to this proxy statement/prospectus as Annex B. All PNAC stockholders are encouraged to read the Amended PubCo Charter in their entirety for a more complete description of their terms.

**Reasons for the Change**

The purpose of this proposal is to provide for director appointment rights in respect of the PubCo Board such that PubCo Directors can be elected in a manner suitable for its operations and its status as a publicly traded company.

**Votes Required for Approval**

The approval of the Governing Documents Proposal C will require the affirmative votes of the holders of at least a majority of the issued and outstanding shares of PNAC Common Stock entitled to vote, who attend, in person or by proxy, and vote thereupon at the Special Meeting.

An abstention or broker non-vote will be counted towards the quorum requirement but will not count as a vote cast at the Special Meeting.

**Recommendation of PNAC Board of Directors**

**THE PNAC BOARD OF DIRECTORS UNANIMOUSLY RECOMMENDS THAT THE PNAC STOCKHOLDERS VOTE “FOR” THE APPROVAL OF THE GOVERNING DOCUMENTS PROPOSAL C.**

The existence of financial and personal interests of one or more of PNAC’s directors results in conflicts of interest on the part of such director(s) between what he, she or they may believe is in the best interests of PNAC and its shareholders and what he, she or they may believe is best for himself, herself or themselves in determining to recommend that shareholders vote for the proposals. In addition, PNAC’s officers have interests in the Business Combination that may conflict with your interests as a shareholder. See the section entitled “*The Business Combination Proposal—Interests of PNAC’s Directors and Executive Officers in the Business Combination*” for a further discussion of these considerations.

**THE GOVERNING DOCUMENTS PROPOSAL D  
(OTHER PROVISIONS INCLUDING STATUS AS A BLANK CHECK COMPANY)**

**Overview**

**Governing Documents Proposal D**—to authorize all other changes arising from or in connection with the effective substitution of PNAC’s certificate of incorporation and bylaws in effect immediately prior to the Merger Effective Time (as defined in the Certificate of Merger) by the Amended PubCo Charter as the governing documents applicable to the holders of PubCo Ordinary Shares, including the removal of certain provisions relating to PNAC’s status as a blank check company that will not be applicable following consummation of the Business Combination.

Assuming the Business Combination Proposal is approved, PNAC stockholders are also being asked to approve Governing Documents Proposal D, which is, in the judgment of PNAC Board, necessary to adequately address the needs of PubCo after the Business Combination.

The Amended PubCo Charter will not contain provisions related to a blank check company (including those related to operation of the Trust Account, winding up of PNAC’s operations should PNAC not complete a business combination by a specified date, and other such blank check-specific provisions as are present in the Existing PNAC Charter) because following the consummation of the Business Combination, PubCo will not be a blank check company.

Approval of each of the four separate proposals constituting the Governing Documents Proposal, assuming approval of the Business Combination Proposal, will result, upon the closing of the Business Combination, in the complete replacement of the Existing PNAC Charter with the Amended PubCo Charter. While certain material changes between the Existing PNAC Charter and the Amended PubCo Charter have been unbundled into distinct Governing Documents Proposals or otherwise identified in this Governing Documents Proposal D, there are other differences between the Existing PNAC Charter and Amended PubCo Charter that will be approved (subject to the approval of the aforementioned related proposals and consummation of the Business Combination) if PNAC stockholders approve this Governing Documents Proposal D. Accordingly, we encourage PNAC stockholders to carefully review the terms of the Amended PubCo Charter, attached hereto as Annex B, as well as the information provided in the “Comparison of Corporate Governance and Shareholder Rights” section of this proxy statement/prospectus.

This summary is qualified by reference to the complete text of the Amended PubCo Charter, copies of which are attached to this proxy statement/prospectus as Annex B. All PNAC stockholders are encouraged to read the Amended PubCo Charter in their entirety for a more complete description of their terms.

**Reasons for the Change**

The PubCo board of directors believes that the elimination of certain provisions related to PNAC’s status as a blank check company is desirable because these provisions will serve no purpose following the Business Combination. For example, the Amended PubCo Charter do not include the requirement to dissolve PubCo upon failure to consummate a business combination in accordance with its terms, and allows PubCo to continue as a corporate entity following the Business Combination. In addition, certain other provisions in PNAC’s current certificate require that proceeds from PNAC’s initial public offering be held in the Trust Account until a business combination or liquidation of PNAC has occurred. These provisions cease to apply once the Business Combination is consummated and are therefore not included in the Amended PubCo Charter.

**Votes Required for Approval**

The approval of the Governing Documents Proposal D will require the affirmative votes of the holders of at least a majority of the issued and outstanding shares of PNAC Common Stock entitled to vote, who attend, in person or by proxy, and vote thereupon at the Special Meeting.

An abstention or broker non-vote will be counted towards the quorum requirement but will not count as a vote cast at the Special Meeting.

**Recommendation of PNAC Board of Directors**

**THE PNAC BOARD OF DIRECTORS UNANIMOUSLY RECOMMENDS THAT THE PNAC STOCKHOLDERS VOTE “FOR” THE APPROVAL OF THE GOVERNING DOCUMENTS PROPOSAL D.**

The existence of financial and personal interests of one or more of PNAC’s directors results in conflicts of interest on the part of such director(s) between what he, she or they may believe is in the best interests of PNAC and its shareholders and what he, she or they may believe is best for himself, herself or themselves in determining to recommend that shareholders vote for the proposals. In addition, PNAC’s officers have interests in the Business Combination that may conflict with your interests as a shareholder. See the section entitled “*The Business Combination Proposal—Interests of PNAC’s Directors and Executive Officers in the Business Combination*” for a further discussion of these considerations.

## THE ADJOURNMENT PROPOSAL

### General

PNAC stockholders are being asked to adopt the Adjournment Proposal.

The Adjournment Proposal, if adopted, shall allow PNAC Board to adjourn the Special Meeting to a later date or dates, if necessary. In no event shall PNAC solicit proxies to adjourn the Special Meeting or consummate the Business Combination beyond the date by which it may properly do so under the PNAC Charter and the DGCL. The purpose of the adjournment proposal is to provide more time to meet the requirements that are necessary to consummate the Business Combination. See the section titled *“The Business Combination Proposal—Interests of PNAC’s Directors and Officers in the Business Combination.”*

### Consequences If the Adjournment Proposal Is Not Approved

If the Adjournment Proposal is presented to the meeting and is not approved by the shareholders, PNAC’s Board may not be able to adjourn the Special Meeting to a later date or dates. In such event, the Business Combination would not be completed.

### Resolution to be Voted Upon

The full text of the resolution to be proposed is as follows:

“RESOLVED, as an ordinary resolution, that the adjournment of the Special Meeting to a later date or dates to be determined by the chairman of the Special Meeting, if necessary, to permit further solicitation and vote of proxies is hereby confirmed, ratified and approved in all respects.”

### Votes Required for Approval

The approval of the Adjournment Proposal will require the consent of the meeting, which means a simple majority of the votes which are cast by those shareholders of PNAC who are present, in person or by proxy, and vote thereupon at the Special Meeting.

An abstention or broker non-vote will be counted towards the quorum requirement but will not count as a vote cast at the Special Meeting.

### Recommendation of PNAC Board of Directors

**THE PNAC BOARD OF DIRECTORS UNANIMOUSLY RECOMMENDS THAT THE PNAC STOCKHOLDERS VOTE “FOR” THE APPROVAL OF THE ADJOURNMENT PROPOSAL.**

The existence of financial and personal interests of one or more of PNAC’s directors results in conflicts of interest on the part of such director(s) between what he, she or they may believe is in the best interests of PNAC and its shareholders and what he, she or they may believe is best for himself, herself or themselves in determining to recommend that shareholders vote for the proposals. In addition, PNAC’s officers have interests in the Business Combination that may conflict with your interests as a shareholder. See the section entitled *“The Business Combination Proposal—Interests of PNAC’s Directors and Executive Officers in the Business Combination”* for a further discussion of these considerations.

## MATERIAL TAX CONSIDERATIONS

### United States Federal Income Tax Considerations

The following is a discussion of U.S. federal income tax considerations generally applicable to U.S. Holders (as defined below) of PNAC Common Stock that either (i) participate in the Business Combination, including of owning and disposing of PNAC Common Stock or (ii) elect to have their PNAC Public Shares redeemed for cash. This discussion addresses only those holders of PNAC Common Stock that hold their PNAC Common Stock as capital assets within the meaning of Section 1221 of the Code (generally, property held for investment). This discussion does not discuss all aspects of U.S. federal income taxation that may be relevant to holders in light of their particular circumstances or status including:

- the PNAC Initial Stockholders;
- financial institutions or financial services entities;
- broker-dealers;
- taxpayers that are subject to the mark-to-market accounting rules;
- tax-exempt entities, qualified retirement plans, individual retirement accounts or other tax-deferred accounts;
- governments or agencies or instrumentalities thereof;
- insurance companies;
- regulated investment companies or real estate investment trusts;
- U.S. expatriates or former long-term residents of the United States;
- persons that own (directly, indirectly, by attribution, or constructively) own five percent or more of our voting shares or five percent or more of the total value of any class of our shares;
- persons that acquired our ordinary shares pursuant to an exercise of employee share options, in connection with employee share incentive plans or otherwise as compensation;
- persons that hold our ordinary shares as part of a straddle, constructive sale, hedging, conversion or other integrated or similar transaction; or
- persons whose functional currency is not the U.S. dollar; or
- controlled foreign corporations or passive foreign investment companies.

This discussion is based on the Code, its legislative history, proposed, temporary and final Treasury Regulations promulgated under the Code, and judicial and administrative interpretations thereof, all as of the date hereof. All of the foregoing is subject to change, which change could apply retroactively and could affect the tax considerations described herein. This discussion does not address U.S. federal taxes other than those pertaining to U.S. federal income taxation (such as estate or gift taxes, the alternative minimum tax or the Medicare tax on investment income), nor does it address any aspects of U.S. state or local or non-U.S. taxation.

We have not and do not intend to seek any rulings from the IRS regarding the Business Combination or an exercise of redemption rights. There can be no assurance that the IRS will not take positions inconsistent with the considerations discussed below or that any such positions would not be sustained by a court.

This discussion does not consider the tax treatment of partnerships or other pass-through entities or persons who hold our ordinary shares through such entities. If a partnership (or any entity or arrangement so characterized for U.S. federal income tax purposes) holds our ordinary shares, the tax treatment of such partnership and a person treated as a partner of such partnership will generally depend on the status of the partner and the activities of the partnership. Partnerships holding any of our ordinary shares and persons that are treated as partners of such partnerships should consult their tax advisors as to the particular U.S. federal income tax consequences of the Business Combination and an exercise of redemption rights to them.

**EACH HOLDER SHOULD CONSULT ITS OWN TAX ADVISOR WITH RESPECT TO THE PARTICULAR TAX CONSEQUENCES TO SUCH HOLDER OF THE BUSINESS COMBINATION AND AN EXERCISE OF REDEMPTION RIGHTS, INCLUDING THE EFFECTS OF U.S. FEDERAL, STATE AND LOCAL AND NON-U.S. TAX LAWS.**

As used herein, a “U.S. Holder” is a beneficial owner of PNAC Common Stock or PubCo Ordinary Shares following the Closing (as the case may be) who or that is, for U.S. federal income tax purposes:

- an individual citizen or resident of the United States,
- a corporation (or other entity that is treated as a corporation for U.S. federal income tax purposes) that is created or organized (or treated as created or organized) in or under the laws of the United States or any state thereof or the District of Columbia,
- an estate whose income is subject to U.S. federal income tax regardless of its source, or
- a trust if (i) a U.S. court can exercise primary supervision over the administration of such trust and one or more U.S. persons have the authority to control all substantial decisions of the trust or (ii) it has a valid election in place to be treated as a U.S. person.

**Effects of the Business Combination to U.S. Holders**

***Effects of the Business Combination to U.S. Holders***

The U.S. federal income tax consequences of the Business Combination will depend primarily upon whether the Business Combination qualifies as a “reorganization” within the meaning of Section 368 of the Code.

Under Section 368(a)(1)(F) of the Code, a reorganization is a “mere change in identity, form, or place of organization of one corporation, however effected” (an “F Reorganization”), and under Section 368(a)(2)(D) of the Code, a reorganization is when “a target corporation is acquired by the subsidiary of a parent” (a “forward triangular merger”). Pursuant to the Business Combination, Merger Sub will merge with and into PNAC, and PNAC becomes a direct, wholly-owned subsidiary of PubCo. Immediately after the Merger, PubCo will, for U.S. federal income tax purposes, own the same assets and be subject to the same liabilities as PNAC immediately prior to the Merger, and will have the same shareholders as PNAC did immediately prior to the Merger.

Messina Madrid Law PA has delivered an opinion that the Business Combination will qualify as an F Reorganization. Such opinion is filed as Exhibit 8.1 to the registration statement of which this proxy statement/prospectus forms a part and is based on customary assumptions, representations and covenants. If any of the assumptions, representations or covenants on which the opinion is based is or becomes incorrect, incomplete, inaccurate or is otherwise not complied with, the validity of the opinion described above may be adversely affected and the tax consequences of the Business Combination could differ from those described herein. An opinion of counsel is not binding on the IRS or any court, and there can be no certainty that the IRS will not challenge the conclusions reflected in the opinion or that a court would not sustain such a challenge.

Assuming that the Business Combination qualifies as an F Reorganization, U.S. Holders of PNAC Common Stock (or PubCo Ordinary Shares following the Merger Closing) will generally not recognize gain or loss for U.S. federal income tax purposes on the Business Combination. The remaining discussion under this section assumes that the Business Combination qualifies as an F Reorganization.

All holders considering exercising redemption rights with respect to their ordinary shares are urged to consult with their tax advisors with respect to the potential tax consequences to them of the Business Combination and an exercise of redemption rights.

***Basis and Holding Period Considerations***

Assuming that the Business Combination qualifies as an F Reorganization: (i) the tax basis of a PubCo Ordinary Share received by a U.S. Holder in the Business Combination will equal the U.S. Holder’s tax basis in the PNAC Share surrendered in exchange therefor, and (ii) the holding period for a share of PubCo Ordinary Share received by a U.S. Holder will include such U.S. Holder’s holding period for the PNAC share surrendered in exchange therefor. However, it is unclear whether the redemption rights with respect to the PNAC Common Stock may prevent the holding period of the PubCo Ordinary Shares from commencing prior to the termination of such rights.



## **U.S. Federal Income Tax Considerations of Owning PubCo Ordinary Shares**

### ***Taxation of Dividends and Other Distributions on PubCo Ordinary Shares***

Subject to the PFIC rules discussed below, if PubCo makes a distribution of cash or other property to a U.S. Holder of PubCo Ordinary Shares, such distributions will generally be treated as a dividend for U.S. federal income tax purposes to the extent the distribution is paid out of PubCo's current or accumulated earnings and profits (as determined under U.S. federal income tax principles). Such dividends will be taxable to a corporate U.S. holder at regular rates and will not be eligible for the dividends-received deduction generally allowed to domestic corporations in respect of dividends received from other domestic corporations.

Distributions in excess of such earnings and profits will generally be applied against and reduce the U.S. Holder's basis in its PubCo Ordinary Shares (but not below zero) and, to the extent in excess of such basis, will be treated as gain from the sale or exchange of such PubCo Ordinary Shares. Because PubCo does not expect to determine its earnings and profits on the basis of U.S. federal income tax principles, any distribution paid by PubCo will generally be reported as a dividend.

With respect to non-corporate U.S. Holders, dividends will generally be taxed at preferential long-term capital gains rates only if (i) PubCo Ordinary Shares are readily tradable on an established securities market in the United States or (ii) PubCo is eligible for the benefits of an applicable income tax treaty, in each case provided that PubCo is not treated as a PFIC in the taxable year in which the dividend was paid or in any previous year and certain other requirements are met. U.S. Holders should consult their tax advisors regarding the availability of the lower rate for any dividends paid with respect to PubCo Ordinary Shares.

### ***Taxation on the Disposition of PubCo Ordinary Shares***

Subject to the PFIC rules discussed below, upon a sale or other taxable disposition of PubCo Ordinary Shares, a U.S. Holder will generally recognize capital gain or loss. The amount of gain or loss recognized will generally be equal to the difference between (i) the sum of the amount of cash and the fair market value of any property received in such disposition and (ii) the U.S. Holder's adjusted tax basis in such ordinary shares.

Under tax law currently in effect, long-term capital gains recognized by non-corporate U.S. Holders are generally subject to U.S. federal income tax at a reduced rate of tax. Capital gain or loss will constitute long-term capital gain or loss if the U.S. Holder's holding period for the ordinary shares exceeds one year. However, it is unclear whether the redemption rights with respect to the PNAC Common Stock may prevent the holding period of the PubCo Ordinary Shares from commencing prior to the termination of such rights. The deductibility of capital losses is subject to various limitations.

### ***PFIC Considerations***

#### ***Definition of a PFIC***

A foreign (i.e., non-U.S.) corporation will be a PFIC for U.S. federal income tax purposes if at least 75% of its gross income in a taxable year of the foreign corporation, including its pro rata share of the gross income of any corporation in which it is considered to own at least 25% of the shares by value, is passive income. Alternatively, a foreign corporation will be a PFIC if at least 50% of its assets in a taxable year of the foreign corporation, ordinarily determined based on fair market value and averaged quarterly over the year, including its pro rata share of the assets of any corporation in which it is considered to own at least 25% of the shares by value, are held for the production of, or produce, passive income. Passive income generally includes dividends, interest, rents and royalties (other than certain rents or royalties derived from the active conduct of a trade or business) and gains from the disposition of passive assets.

Pursuant to a start-up exception, a corporation will not be a PFIC for the first taxable year the corporation has gross income, if (1) no predecessor of the foreign corporation was a PFIC; (2) the corporation satisfies the IRS that it will not be a PFIC for either of the first two taxable years following the start-up year; and (3) the corporation is not in fact a PFIC for either of those years.

### ***PFIC Status of PNAC and PubCo***

Although a foreign corporation's PFIC determination will be made annually, a determination that PNAC or PubCo is a PFIC will generally continue to apply to subsequent years in which a U.S. Holder continues to hold shares in such entity (including a successor entity), whether or not such entity is a PFIC in those subsequent years. Because, following the Business Combination, PubCo will be treated as the successor to PNAC for U.S. federal income tax purposes, any PubCo Ordinary Shares received in exchange for PNAC Common Stock in the Business Combination may, in the absence of certain elections described below, be treated as stock of a PFIC if PNAC was treated as a PFIC during the holding period of a U.S. Holder.

Based on the anticipated timing of the Business Combination, the anticipated assets and income of the combined company and the application of the start-up exception, PNAC or its successor PubCo (as the case may be) are not currently expected to be treated as a PFIC for the current taxable year ending on December 31, 2022 (the "Current Taxable Year") or the foreseeable future. However, as further discussed below, the facts on which any determination of PFIC status are based may not be known until the close of each taxable year in question, and, in the case of the Current Taxable Year, until as late as the close of two subsequent taxable years. Additionally, there is uncertainty regarding the application of the start-up exception.

Although PNAC or PubCo (as the case may be) will likely meet the PFIC income or asset tests for the Current Taxable Year, the start-up exception is expected to apply to prevent such entity from being treated as a PFIC for the Current Taxable Year provided that the combined company does not meet either test in the two years subsequent to the Current Taxable Year. Based on the anticipated timing of the Business Combination and the anticipated assets and income of the combined company, PubCo is not expected to meet either test for the year following the Current Taxable Year or the foreseeable future. However, the timing of the Business Combination is not certain. If the Business Combination is completed later than expected, it is possible that PubCo is treated as a PFIC for the taxable year following the Current Taxable Year, in which case the start-up exception will not apply. Additionally, if the Business Combination is completed in the Current Taxable Year, it is possible that the Service takes the position that the start-up exception does not apply to the Current Taxable Year based on the view, consistent with a 2002 Field Service Advisory, that PNAC was a PFIC for the taxable year ending December 31, 2022, despite the fact that PNAC (PubCo's predecessor) had no gross income in such taxable year. Moreover, because PFIC status is an annual factual determination, PubCo may become a PFIC in future if the composition of its income or assets, or the market price of the PubCo Ordinary Shares, were to change, regardless of whether the Business Combination is completed within the expected timing or the start-up exception applies. Accordingly, there can be no assurance with respect to the PFIC status of PNAC or PubCo for the Current Taxable Year or any future taxable year.

### ***Application of PFIC Rules to Ordinary Shares***

If (i) PNAC or PubCo is determined to be a PFIC for any taxable year (or portion thereof) that is included in the holding period of a U.S. Holder and (ii) the U.S. Holder did not make a timely and effective QEF election for PNAC's or PubCo's (as the case may be) first taxable year as a PFIC in which the U.S. Holder held ordinary shares (whether PNAC Ordinary Shares or PubCo Ordinary Shares) (such taxable year as it relates to each U.S. Holder, the "First PFIC Holding Year"), a QEF election along with a purging election, or a "mark-to-market" election, each as described below under "QEF Election, Mark-to-Market Election and Purging Election," then such holder will generally be subject to special rules (the "Default PFIC Regime") with respect to:

- any gain recognized by the U.S. Holder on the sale or other disposition of its PubCo Ordinary Shares; and
- any "excess distribution" made to the U.S. Holder (generally, any distributions to such U.S. Holder during a taxable year of the U.S. Holder that are greater than 125% of the average annual distributions received by such U.S. Holder in respect of its ordinary shares during the three preceding taxable years of such U.S. Holder or, if shorter, such U.S. Holder's holding period for such ordinary shares).

Under the Default PFIC Regime:

- the U.S. Holder's gain or excess distribution will be allocated ratably over the U.S. Holder's holding period for its PubCo Ordinary Shares (taking into account the relevant holding period of the PNAC Common Stock exchanged therefor);
- the amount of gain allocated to the U.S. Holder's taxable year in which the U.S. Holder recognized the gain or received the excess distribution, or to the period in the U.S. Holder's holding period before the first day of the first taxable year in which PNAC was or PubCo is a PFIC, will be taxed as ordinary income;
- the amount of gain allocated to other taxable years (or portions thereof) of the U.S. Holder and included in such U.S. Holder's holding period will be taxed at the highest tax rate in effect for that year and applicable to the U.S. Holder; and
- an additional tax equal to the interest charge generally applicable to underpayments of tax will be imposed on the U.S. Holder in respect of the tax attributable to each such other taxable year of such U.S. Holder.

**ALL U.S. HOLDERS ARE URGED TO CONSULT THEIR TAX ADVISORS REGARDING THE EFFECTS OF THE PFIC RULES ON THE REDEMPTION OF PNAC COMMON STOCK OR ON THE OWNERSHIP OR DISPOSITION OF PUBCO ORDINARY SHARES, INCLUDING THE IMPACT OF ANY PROPOSED OR FINAL TREASURY REGULATIONS.**

***QEF Election, Mark-to-Market Election and Purging Election***

In general, if PNAC or PubCo is determined to be a PFIC, a U.S. Holder may avoid the Default PFIC Regime with respect to its ordinary shares by making a timely and effective "qualified electing fund" election under Section 1295 of the Code (a "QEF Election") for such holder's First PFIC Holding Year. In order to comply with the requirements of a QEF election with respect to PubCo Ordinary Shares, a U.S. Holder must receive certain information from PubCo. Because PubCo does not intend to provide such information, however, the QEF Election will not be available to U.S. Holders with respect to PubCo Ordinary Shares. U.S. Holders are urged to consult their tax advisors with respect to any QEF Election previously made with respect to PNAC Common Stock.

Alternatively, if a U.S. Holder, at the close of its taxable year, owns (or is deemed to own) shares in a PFIC that are treated as marketable shares, the U.S. Holder may make a mark-to-market election with respect to such shares for such taxable year. If the U.S. Holder makes a valid mark-to-market election for such holder's First PFIC Holding Year, such holder will generally not be subject to the Default PFIC Regime in respect to its ordinary shares as long as such shares continue to be treated as marketable shares. Instead, the U.S. Holder will generally include as ordinary income for each year in its holding period that PubCo or PNAC is treated as a PFIC the excess, if any, of the fair market value of its ordinary shares at the end of its taxable year over the adjusted basis in its ordinary shares. The U.S. Holder also will be allowed to take an ordinary loss in respect of the excess, if any, of the adjusted basis of its PubCo Ordinary Shares over the fair market value of its ordinary shares at the end of its taxable year (but only to the extent of the net amount of previously included income as a result of the mark-to-market election). The U.S. Holder's basis in its ordinary shares will be adjusted to reflect any such income or loss amounts, and any further gain recognized on a sale or other taxable disposition of the ordinary shares in a taxable year in which PNAC or PubCo is treated as a PFIC will be treated as ordinary income. Special tax rules may also apply if a U.S. Holder makes a mark-to-market election for a taxable year after such holder's First PFIC Holding Year.

The mark-to-market election is available only for stock that is regularly traded on a national securities exchange that is registered with the Securities and Exchange Commission, including the Nasdaq. U.S. Holders should consult their own tax advisors regarding the availability and tax consequences of a mark-to-market election in respect of PNAC Common Stock or PubCo Ordinary Shares under their particular circumstances.

PubCo Ordinary Shares treated as stock of a PFIC under the Default PFIC Regime (including PubCo Ordinary Shares received in exchange for PNAC Common Stock that were so treated at the time of the Business Combination) will continue to be treated as stock of a PFIC, including in taxable years in which PubCo ceases to be a PFIC, unless the applicable U.S. Holder makes a “purging election” with respect to such shares. Under one type of purging election, the U.S. Holder will be deemed to have sold such shares at their fair market value on the last day of the last year in which PNAC or PubCo, as applicable, is treated as a PFIC, and any gain recognized on such deemed sale will be treated as an excess distribution, as described above. As a result of this election, the U.S. Holder will have additional basis (to the extent of any gain recognized in the deemed sale) and, solely for purposes of the PFIC rules, a new holding period in such holder’s PubCo Ordinary Shares. U.S. Holders are urged to consult their tax advisors regarding the application of the purging elections rules to their particular circumstances.

If PubCo is a PFIC and, at any time, has a foreign subsidiary that is classified as a PFIC, U.S. Holders would generally be deemed to own a portion of the shares of such lower-tier PFIC, and generally could incur liability for the deferred tax and interest charge described above if PubCo receives a distribution from, or disposes of all or part of PubCo’s interest in, the lower-tier PFIC or the U.S. Holders otherwise were deemed to have disposed of an interest in the lower-tier PFIC. A mark-to-market election generally would not technically be available with respect to such lower-tier PFIC. U.S. Holders are urged to consult their own tax advisors regarding the tax issues raised by lower-tier PFICs.

A U.S. Holder that owns (or is deemed to own) shares in a PFIC during any taxable year of the U.S. Holder, may have to file an IRS Form 8621 (whether or not a QEF or market-to-market election is made) with such U.S. Holder’s U.S. federal income tax return and provide such other information as may be required by the U.S. Treasury Department. The rules dealing with PFICs and with the QEF and mark-to-market elections are very complex and are affected by various factors in addition to those described above. Accordingly, U.S. Holders of PubCo Ordinary Shares should consult their own tax advisors concerning the application of the PFIC rules to PubCo Ordinary Shares under their particular circumstances.

**THE RULES DEALING WITH PFICs ARE VERY COMPLEX AND ARE IMPACTED BY VARIOUS FACTORS IN ADDITION TO THOSE DESCRIBED ABOVE. ALL U.S. HOLDERS ARE URGED TO CONSULT THEIR TAX ADVISORS REGARDING THE CONSEQUENCES TO THEM OF THE PFIC RULES, INCLUDING, WITHOUT LIMITATION, WHETHER A QEF ELECTION, A MARK-TO-MARKET ELECTION OR ANY OTHER ELECTION IS AVAILABLE AND THE CONSEQUENCES TO THEM OF ANY SUCH ELECTION, AND THE IMPACT OF ANY PROPOSED OR FINAL PFIC TREASURY REGULATIONS.**

#### **Effects to U.S. Holders of Exercising Redemption Rights**

Subject to the PFIC rules discussed above, the U.S. federal income tax consequences to a U.S. Holder of ordinary shares that exercises its redemption rights to receive cash in exchange for all or a portion of its ordinary shares will depend on whether the redemption qualifies as a sale of such shares redeemed under Section 302 of the Code or is treated as a distribution under Section 301 of the Code, as well as on whether such holder has made a timely QEF Election or mark-to-market election (each as discussed above).

It is expected that a redeeming U.S. Holder will generally be treated as selling its ordinary shares. The redemption of ordinary shares will generally qualify as a sale of the ordinary shares that are redeemed if such redemption (i) is “substantially disproportionate” with respect to the redeeming U.S. Holder, (ii) results in a “complete termination” of such U.S. Holder’s interest or (iii) is “not essentially equivalent to a dividend” with respect to such U.S. Holder. These tests are explained more fully below.

For purposes of such tests, a U.S. Holder takes into account not only ordinary shares actually owned by such U.S. Holder, but also ordinary shares that are constructively owned by such U.S. Holder. A redeeming U.S. Holder may constructively own, in addition to ordinary shares owned directly, ordinary shares owned by certain related individuals and entities in which such U.S. Holder has an interest or that have an interest in such U.S. Holder, as well as any ordinary shares such U.S. Holder has a right to acquire by exercise of an option, which would generally include shares which could be acquired pursuant to the exercise of the warrants.

The redemption of ordinary shares will generally be “substantially disproportionate” with respect to a redeeming U.S. Holder if the percentage of the respective entity’s outstanding voting shares that such U.S. Holder actually or constructively owns immediately after the redemption is less than 80% of the percentage of the respective entity’s outstanding voting shares that such U.S. Holder actually or constructively owned immediately before the redemption. Prior to the Business Combination, the ordinary shares may not be treated as voting shares for this purpose and, consequently, this substantially disproportionate test may not be applicable. There will be a complete termination of such U.S. Holder’s interest if either (i) all of the ordinary shares actually or constructively owned by such U.S. Holder are redeemed or (ii) all of the ordinary shares actually owned by such U.S. Holder are redeemed and such U.S. Holder is eligible to waive, and effectively waives in accordance with specific rules, the attribution of ordinary shares owned by certain family members and such U.S. Holder does not constructively own any other ordinary shares. The redemption of ordinary shares will not be essentially equivalent to a dividend if it results in a “meaningful reduction” of such U.S. Holder’s proportionate interest in the respective entity. Whether the redemption will result in a meaningful reduction in such U.S. Holder’s proportionate interest will depend on the particular facts and circumstances applicable to it. The IRS has indicated in a published ruling that even a small reduction in the proportionate interest of a small minority shareholder in a publicly held corporation who exercises no control over corporate affairs may constitute such a “meaningful reduction.”

If none of the above tests is satisfied, a redemption will be treated as a distribution under Section 301 of the Code with respect to ordinary shares, and the tax effects will be as described for distributions on PubCo Ordinary Shares under “—*Taxation of Dividends and Other Distributions on PubCo Ordinary Shares*” above. After the application of those rules, any remaining tax basis a U.S. Holder has in the redeemed ordinary shares will be added to the adjusted tax basis in such holder’s remaining ordinary shares. If there are no remaining ordinary shares, a U.S. Holder should consult its own tax advisors as to the allocation of any remaining basis.

Certain U.S. Holders may be subject to special reporting requirements with respect to a redemption of ordinary shares, and such holders should consult with their own tax advisors with respect to their reporting requirements.

**ALL U.S. HOLDERS CONSIDERING EXERCISING REDEMPTION RIGHTS WITH RESPECT TO THEIR ORDINARY SHARES ARE URGED TO CONSULT WITH THEIR TAX ADVISORS WITH RESPECT TO THE TAX CONSEQUENCES TO THEM OF AN EXERCISE OF REDEMPTION RIGHTS, INCLUDING THE POTENTIAL TAX CONSEQUENCES TO THEM OF THE BUSINESS COMBINATION.**

### **Cayman Islands Tax Considerations**

The following summary contains a description of certain Cayman Islands income tax consequences of the acquisition, ownership and disposition of ordinary shares, but it does not purport to be a comprehensive description of all the tax considerations that may be relevant to a decision to purchase ordinary shares. The summary is based upon the tax laws of Cayman Islands and regulations thereunder as of the date hereof, which are subject to change.

Prospective investors should consult their professional advisors on the possible tax consequences of buying, holding or selling any shares under the laws of their country of citizenship, residence or domicile.

The following is a discussion on certain Cayman Islands income tax consequences of an investment in the PNAC Common Stock and PubCo Ordinary Shares. The discussion is a general summary of present law, which is subject to prospective and retroactive change. It is not intended as tax advice, does not consider any investor’s particular circumstances, and does not consider tax consequences other than those arising under Cayman Islands law.

#### ***Under Existing Cayman Islands Laws:***

Payments of dividends and capital in respect of PNAC Securities and PubCo Ordinary Shares will not be subject to taxation in the Cayman Islands and no withholding will be required on the payment of interest and principal or a dividend or capital to any holder of PNAC Common Stock or PubCo Ordinary Shares, as the case may be, nor will gains derived from the disposal of the PNAC Common Stock or PubCo Ordinary Shares be subject to Cayman Islands income or corporation tax. The Cayman Islands currently have no income, corporation or capital gains tax and no estate duty, inheritance tax or gift tax.

No stamp duty is payable in respect of the issue of PNAC securities or PubCo Ordinary Shares or on an instrument of transfer in respect of a PNAC security or a PubCo Ordinary Share.

PubCo has been incorporated under the laws of the Cayman Islands as exempted companies with limited liability and, as such, [has] obtained undertakings from the Governor in Cabinet of the Cayman Islands in the following form:

***The Tax Concessions Law***

***Undertaking as to Tax Concessions***

In accordance with Section 6 of the Tax Concessions Law the following undertaking is hereby given to PubCo (the “Company”):

- (a) That no Law which is hereafter enacted in the Cayman Islands imposing any tax to be levied on profits, income, gains or appreciations shall apply to the Company or its operations; and
- (b) In addition, that no tax to be levied on profits, income, gains or appreciations or which is in the nature of estate duty or inheritance tax shall be payable
  - (i) on or in respect of the shares debentures or other obligations of the Company; or
  - (ii) by way of the withholding in whole or part of any relevant payment as defined in the Tax Concessions Law.

These concessions shall be for a period of TWENTY years from the [ ].

The Cayman Islands currently levy no taxes on individuals or corporations based upon profits, income, gains or appreciations and there is no taxation in the nature of inheritance tax or estate duty. There are no other taxes likely to be material to PubCo levied by the Government of the Cayman Islands save certain stamp duties which may be applicable, from time to time, on certain instruments executed in or brought within the jurisdiction of the Cayman Islands.

The Cayman Islands enacted the International Tax Co-operation (Economic Substance) Act (2021 Revision) together with the Guidance Notes published by the Cayman Islands Tax Information Authority from time to time. The Company is required to comply with the economic substance requirements from July 1, 2019 and make an annual report in the Cayman Islands as to whether or not it is carrying on any relevant activities and if it is, it must satisfy an economic substance test.

## UNAUDITED PRO FORMA CONDENSED COMBINED FINANCIAL INFORMATION

### Introduction

The following unaudited pro forma condensed combined balance sheet as of December 31, 2022 and the unaudited pro forma condensed combined statement of operations for the year ended December 31, 2022, present the combination of financial information of noco-noco Pte. Ltd. (“noco-noco”) and Prime Number Acquisition I Corp (“PNAC”) after giving effect on the Business Combination Transactions and related adjustments described in the accompanying notes, and have been prepared in accordance with Article 11 of Regulation S-X.

noco-noco Pte. Ltd. is a platform-solution provider of decarbonization offerings, aim to truly solve urgent environmental crises through the comprehensive decarbonization of all forms of transportation.

Prime Number Acquisition I Corp. (“PNAC”) is a newly organized blank check company incorporated as a Delaware corporation on February 25, 2021. The Company was formed for the purpose of effecting a merger, share exchange, asset acquisition, share purchase, reorganization or similar business combination with one or more businesses or entities (the “Business Combination”).

### Description of the Business Combination

On December 29, 2022, the board of directors of Prime Number Acquisition I Corp., a Delaware corporation (“PNAC”), has unanimously approved the Business Combination Agreement, by and among Prime Number Holding Limited, an exempted company limited by shares incorporated under the laws of the Cayman Islands (“PubCo”), PNAC, Prime Number Merger Sub Inc., a Delaware corporation and a direct wholly-owned subsidiary of PubCo (“Merger Sub”), Prime Number New Sub Pte. Ltd., a Singapore private company limited by shares and a direct wholly-owned subsidiary of PubCo (“New SubCo”), noco-noco Pte. Ltd., a Singapore private company limited by shares (“noco-noco”), and certain shareholders of noco-noco collectively holding a controlling interest (together with other shareholders of noco-noco subsequently joining the transactions, the “Sellers”), pursuant to which PNAC is proposing to enter into a business combination with noco-noco involving a merger and a share exchange, among which: (i) Merger Sub shall merge with and into PNAC, with PNAC as the surviving entity and a wholly-owned subsidiary of PubCo (the “Merger”), (ii) New SubCo shall acquire all of the issued and outstanding shares of noco-noco from the Sellers, and in exchange, PubCo shall issue to the Sellers the ordinary shares of PubCo, with noco-noco becoming a subsidiary of New SubCo and an indirect subsidiary of PubCo (the “Share Exchange”, and together with the Merger and the other transactions contemplated by the Business Combination Agreement, the “Business Combination”). Upon the consummation of the Business Combination, each of PNAC and noco-noco would become a subsidiary of PubCo, and PNAC stockholders and the Sellers would receive ordinary shares, par value \$0.0001 per share, of PubCo (“PubCo Ordinary Shares”) as consideration and become the shareholders of PubCo.

The unaudited pro forma condensed combined balance sheet as of December 31, 2022 and the unaudited pro forma condensed combined statement of operations for the year ended December 31, 2022 give pro forma effect to the Business Combination consummated on December 31, 2022 treated as a reverse recapitalization for accounting purposes and the Private Placement as if they had been consummated as of January 1, 2022.

The unaudited pro forma condensed financial information has been prepared in conformity with U.S. generally accepted accounting principles (“GAAP”) in U.S. dollars. The unaudited pro forma condensed combined financial information is based on the historical financial statements of noco-noco and PNAC for the year ended December 31, 2022 (see Note 5 for the detail breakdown of the unaudited condensed statement of operations between January 1, 2022, and June 30, 2022 and between July 1, 2022, and December 31, 2022), giving effect to the transaction as if it occurred on January 1, 2022 and reflecting the pro forma adjustments expected to have a continuing impact on the combined results.

The unaudited pro forma condensed combined financial information has been prepared using the assumptions below:

- **Scenario A—Assuming No Redemptions:** This presentation assumes that no shareholders of PNAC elect to have their PNAC Shares redeemed for cash in connection with the Business Combination as permitted by PNAC’s amended and restated memorandum and articles of association.
- **Scenario D—Assuming Maximum Redemptions:** This presentation assumes that the shareholders of PNAC elect to redeem all remaining shares and 806,250 PubCo Ordinary Shares are issued in exchange for PNAC rights.

Included below is the expected number of shares to be issued, and the related ownership interests, at the completion of the transaction under the two scenarios:

Holders of PubCo Ordinary Shares	Scenario A-No Redemption		Scenario D-Maximum Redemption <sup>(2)</sup>	
	No. of Shares	Voting Power	No. of Shares	Voting Power
<b>PNAC Public Stockholders</b>	4,912,299 <sup>(1)</sup>	3.54%	— <sup>(1)</sup>	0.00%
<b>PNAC Public Stockholders (“Rights”)</b>	806,250	0.58%	806,250	0.60%
<b>PNAC Initial Stockholders<sup>(3)</sup></b>	2,011,392	1.45%	2,011,392	1.50%
Prime Number Acquisition LLC	1,732,732	1.25%	1,732,732	1.29%
Glorious Capital LLC	140,160	0.10%	140,160	0.10%
Kris Yang	3,500	0.00%	3,500	0.00%
Dongfeng Wang	45,000	0.03%	45,000	0.03%
<b>Total: PNAC Sponsors and Affiliates</b>	1,921,392	1.38%	1,921,392	1.43%
Dongfeng Wang	45,000	0.03%	45,000	0.03%
David Friedman	30,000	0.02%	30,000	0.02%
Chris Dunn	15,000	0.01%	15,000	0.01%
H. David Sherman	15,000	0.01%	15,000	0.01%
Qinyu Wang	15,000	0.01%	15,000	0.01%
Sarah Gu	15,000	0.01%	15,000	0.01%
<b>Total: PNAC Directors, Officers and Secretary</b>	135,000	0.10%	135,000	0.10%
<b>The Sellers</b>	130,560,928	94.00%	130,560,928	97.44%
<b>PNCPS compensation shares</b>	609,756	0.44%	609,756	0.46%
<b>Pro Forma PubCo Ordinary Shares at Closing</b>	138,900,625	100.00%	133,988,326	100.00%

- (1). As of the date of this proxy statement/prospectus, there are 4,912,299 PNAC Public Shares issued and outstanding that are subject to redemption.
- (2). The numbers set forth in this column assume that all PNAC Public Shares are redeemed and 806,250 PubCo Ordinary Shares are issued in exchange for PNAC rights.
- (3). PNAC Initial Stockholders' equity interests following the Business Combination include PubCo Ordinary Shares in exchange for 1,612,500 founder shares of PNAC and 398,892 private placement shares of PNAC.

The following unaudited pro forma condensed combined balance sheet as of December 31, 2022 under the no redemption scenario and maximum redemption scenario are based on the historical financial statements of Subco and PNAC, respectively. The unaudited pro forma adjustments are based on information currently available, and assumption and estimates underlying the unaudited pro forma adjustments are described in the accompanying notes. Actual results may differ materially from the assumptions used to present the accompanying unaudited pro forma condensed combined financial information.



**UNAUDITED PRO FORMA CONDENSED COMBINED BALANCE SHEETS  
AS OF DECEMBER 31, 2022**

	Subco (noco-noco)	PNAC	No redemption scenario		Maximum redemption scenario	
			Transaction Accounting Adjustments	Pro Forma Combined	Transactions Accounting Adjustments	Pro Forma Combined
<b>ASSETS</b>						
<b>Current Assets</b>						
Cash and cash equivalents	\$ 214,449	\$ 278,295	\$ 50,634,168 (c) (3,783,826) (e) (500,000) (g) 24,000 (h)	\$ 46,867,085	\$ (516,744) (e)	\$ - (h)
Deposit and prepayments	302,626	125,384	-	428,010	-	428,010
Total current assets	517,075	403,679	46,374,341	47,295,095	(492,744)	428,010
Cash and marketable securities held in trust account	-	66,718,520	(16,084,352) (a) (50,634,168) (b)	-	(16,084,352) (a)	- (b)
Property and equipment, net	14,594	-	-	14,594	-	14,594
Right of used asset	305,829	-	-	305,829	-	305,829
<b>TOTAL ASSETS</b>	<b>\$ 837,498</b>	<b>\$ 67,122,199</b>	<b>\$ (20,344,179)</b>	<b>\$ 47,615,519</b>	<b>\$ (67,211,264)</b>	<b>\$ 784,433</b>
<b>LIABILITIES AND SHAREHOLDERS' EQUITY (DEFICIT)</b>						
<b>Current Liabilities</b>						
Account payable	\$ -	\$ 90,004	\$ 1,054,271 (e)	\$ 1,144,275	\$ 4,321,353 (e)	\$ 4,911,357 (g)
Accruals and other payables	27,266	149,636	-	176,902	-	176,902
Amount due to related party	1,681,003	-	24,000 (h)	1,705,003	24,000 (h)	1,705,003
Loan from third party	-	43,853	-	43,853	-	43,853
Lease liabilities - current	169,334	-	-	169,334	-	169,334
	1,877,603	283,493	1,078,271	3,239,367	4,845,353	7,006,449
<b>Non-Current Liabilities</b>						
Lease liabilities - non current	124,918	-	-	124,918	-	124,918
Deferred underwriting fee payable	-	2,257,500	(2,257,500) (e)	-	(2,257,500) (e)	-
Long-term provision	-	-	-	-	-	-
<b>TOTAL LIABILITIES</b>	<b>2,002,521</b>	<b>2,540,993</b>	<b>(1,179,229)</b>	<b>3,364,285</b>	<b>2,587,853</b>	<b>7,131,367</b>
<b>COMMITMENTS AND CONTINGENCIES</b>						
Common stock subject to possible redemption, \$0.0001 par value, 6,450,000 shares at redemption value of \$10.34 per share	-	66,718,520	(15,899,828) (a) (50,818,692) (b)	-	(15,899,828) (a)	(0) (b)
<b>Shareholders' equity (deficit)</b>						
Common stock	2,348,091	201	574 (b) (2,335,034) (d) 61 (g)	13,892	81 (b)	13,399 (d)
Additional paid in capital	-	-	(184,524) (a) 50,818,118 (b) 2,335,034 (d) (1,054,271) (e) (2,137,515) (f) 6,249,938 (g)	56,026,780	(184,524) (a) 184,443 (b) 2,335,034 (d) (1,054,271) (e) (2,137,515) (f) 6,249,938 (g)	5,393,105 (g)
Other accumulated comprehensive income	(6,720)	-	-	(6,720)	-	(6,720)
Accumulated deficit	(3,506,393)	(2,137,515)	(1,526,326) (e) 2,137,515 (f) (6,749,999) (g)	(11,782,718)	(1,526,326) (e) 2,137,515 (f) (6,749,999) (g)	(11,782,718) (g)
Total shareholders' deficit	(1,165,023)	64,581,206	(19,164,950)	44,251,234	(69,799,117)	(6,382,934)
<b>TOTAL LIABILITIES AND SHAREHOLDERS' EQUITY (DEFICIT)</b>	<b>837,498</b>	<b>67,122,199</b>	<b>(20,344,179)</b>	<b>47,615,519</b>	<b>(67,211,264)</b>	<b>784,433</b>

*See notes to the unaudited pro forma condensed combined financial statements*

**UNAUDITED PRO FORMA CONDENSED COMBINED STATEMENT OF OPERATIONS  
FOR THE YEAR ENDED DECEMBER 31, 2022**

	Subco (noco-noco) (See Note 5)	PNAC	No redemption scenario		Maximum redemption scenario		
			Transaction Accounting Adjustments	Pro Forma Combined	Transactions Accounting Adjustments	Pro Forma Combined	
<b>Operating expenses:</b>							
Research and development	137,412	-	-	137,412	-	137,412	
Selling, general and administrative expenses	1,529,742	588,973	1,526,326 (4a) 6,749,999 (f)	10,395,040	1,526,326 (4a) 6,749,999 (f)	10,395,040	
Franchise tax expenses	-	47,980	-	47,980	-	47,980	
<b>Total operating expenses</b>	<b>1,667,154</b>	<b>636,953</b>	<b>8,276,325</b>	<b>10,580,432</b>	<b>8,276,325</b>	<b>10,580,432</b>	
Loss from operation	(1,667,154)	(636,953)	(8,276,325)	(10,580,432)	(8,276,325)	(10,580,432)	
<b>Other income/(expense)</b>							
Other income	30,157	928,520	(928,250)	30,157	(928,250)	30,157	
Foreign exchange gain (loss)	8,352	-	-	8,352	-	8,352	
<b>Total other income/(expense)</b>	<b>38,509</b>	<b>928,520</b>	<b>(928,250)</b>	<b>38,509</b>	<b>(928,250)</b>	<b>38,509</b>	
<b>Loss before income taxes</b>	<b>(1,628,645)</b>	<b>291,567</b>	<b>(9,204,845)</b>	<b>(10,541,923)</b>	<b>\$ (9,204,845)</b>	<b>\$ (10,541,923)</b>	
Income tax expenses	-	(149,636)	-	(149,636)	-	(149,636)	
<b>Net loss</b>	<b>\$ (1,628,645)</b>	<b>\$ 141,931</b>	<b>\$ (9,204,845)</b>	<b>\$ (10,691,599)</b>	<b>\$ (9,204,845)</b>	<b>\$ (10,691,599)</b>	
Less: Net loss attributable to non-controlling interests	-	-	-	-	-	-	
<b>Net loss attributable to equity holders of the Company</b>	<b>\$ (1,628,645)</b>	<b>\$ 141,931</b>	<b>\$ (9,204,845)</b>	<b>\$ (10,691,599)</b>	<b>\$ (9,204,845)</b>	<b>\$ 10,691,599)</b>	
<b>Other comprehensive loss:</b>							
Foreign currency translation adjustment	(1,266)	-	-	(1,266)	-	(1,266)	
<b>Comprehensive loss</b>	<b>\$ (1,629,911)</b>	<b>\$ 141,931</b>	<b>\$ (9,204,845)</b>	<b>\$ (10,692,825)</b>	<b>\$ (9,204,845)</b>	<b>\$ (10,692,825)</b>	
Less: net comprehensive loss attributable to non-controlling interest	-	-	-	-	-	-	
<b>Net Comprehensive loss attributable to equity holders of the Company</b>	<b>\$ (1,629,911)</b>	<b>\$ 141,931</b>	<b>\$ (9,204,845)</b>	<b>\$ (10,692,825)</b>	<b>\$ (9,204,845)</b>	<b>\$ (10,692,825)</b>	
Basic and diluted loss per ordinary share	<u>(5.21)</u>	<u>(1.90)</u>		<u>(0.08)</u>		<u>(0.08)</u>	
Basic and diluted weighted average number of ordinary shares outstanding	<u>312,664</u>	<u>1,906,243</u>		<u>138,900,625</u>		<u>133,988,326</u>	

*See notes to the unaudited pro forma condensed combined financial statements*

## Note 1 – Basis of Presentation

The unaudited pro forma condensed combined financial information has been prepared to illustrate the effect of the Business Combination and has been prepared for informational purposes only.

The historical financial statements for Subco and PNAC have been prepared in accordance with U.S. GAAP.

The Sellers will hold the majority ownership interest. Under the no redemption scenario, PNAC initial and public stockholders, and Transaction Financing Investors will hold 6.98% ownership interest compared to the 93.02% ownership interest of The Sellers. Under the maximum redemption scenario, PNAC initial and public stockholders, and Transaction Financing Investors will hold 2.54% ownership interest compared to the 97.46% ownership interest of The Sellers.

Accordingly, for accounting purposes, the financial statements of the combined company will represent a continuation of the consolidated financial statements of PNAC with the acquisition being treated as the equivalent of PNAC issuing shares for the net assets of Subco, accompanied by a recapitalization. The net assets of PNAC and Subco will be stated at historical cost, with no goodwill or other intangible assets recorded.

PNAC and Subco did not have any historical relationship prior to the Business Combination. Accordingly, no pro forma adjustments were required to eliminate activities between the companies.

The unaudited pro forma condensed combined balance sheet as of December 31, 2022 and the unaudited pro forma condensed combined statements of operations for year ended December 31, 2022 are based on the historical financial statements of PNAC and Subco, and the pro forma information reflects a PubCo per share price of \$10.34 in the Trust Account based on the estimated redemption price of \$10.34 per share as of December 31, 2022. The accounting adjustments for the Business Combination consist of those necessary to account for the Business Combination.

The unaudited pro forma condensed combined balance sheet as of December 31, 2022 has been prepared using, and should be read in conjunction with, the following:

- Subco's unaudited balance sheet as of December 31, 2022, and the related notes for the period ended December 31, 2022, included elsewhere in this proxy statement/prospectus; and
- PNAC's audited consolidated balance sheet as of December 31, 2022, and the related notes for the year ended December 31, 2022 included elsewhere in this proxy statement/prospectus; and

The unaudited pro forma condensed combined statement of operations for the year ended December 31, 2022 has been prepared using, and should be read in conjunction with, the following:

- Subco's unaudited statement of operations for the six months ended December 31, 2022 and the related notes included elsewhere in this proxy statement/prospectus; and
- PNAC's audited statement of operations for the year ended December 31, 2022 and the related notes included elsewhere in this proxy statement/prospectus.

Information has been prepared based on these preliminary estimates, and the final amounts recorded may differ materially from the information presented. The unaudited pro forma condensed combined financial information does not give effect to any anticipated synergies, operating efficiencies, tax savings, or cost savings that may be associated with the Business Combination.

Management has made significant estimates and assumptions in its determination of the pro forma adjustments. The pro forma adjustments reflecting the consummation of the Business Combination are based on certain currently available information and certain assumptions and methodologies that PNAC believes are reasonable under the circumstances. The unaudited condensed pro forma adjustments, which are described in the accompanying notes, may be revised as additional information becomes available and is evaluated. Therefore, it is likely that the actual adjustments will differ from the pro forma adjustments and it is possible the difference may be material. PNAC believes that these assumptions and methodologies provide a reasonable basis for presenting all of the significant effects of the Business Combination based on information available to management at the time and that the pro forma adjustments give appropriate effect to those assumptions and are properly applied in the unaudited pro forma condensed combined financial information.

The unaudited pro forma condensed combined financial information is not necessarily indicative of what the actual results of operations and financial position would have been had the Transactions taken place on the dates indicated, nor are they indicative of the future consolidated results of operations or financial position of the combined company. They should be read in conjunction with the historical financial statements and notes thereto of PNAC and Subco.

#### **Note 2 – Accounting Policies**

Based on an initial analysis in preparation for the Business Combination, management did not identify any differences between the two entities' accounting policies that would have a material impact on the unaudited pro forma condensed combined financial information. As a result, the unaudited pro forma condensed combined financial information does not assume any differences in accounting policies.

#### **Note 3 – Adjustments to Unaudited Pro Forma Condensed Combined Statement of Financial Position**

Pro forma adjustments to the attached condensed combined financial statements include the following:

- a) Represents the redemption of 1,517,701 shares as of date of proxy statement/prospectus
- b) Represents the redemption of shares subjected to possible redemption and all remaining outstanding common shares are converted into Combined Company common shares
- c) Represents the reclassification of cash and investments held in the Trust Account that becomes available following the Business Combination
- d) Represents the reclassification of ordinary shares of SubCo to additional paid-in capital
- e) Represents estimated transaction cost of approximately \$3.78 million incurred in connection with the Business Combination, approximately \$2.26 million payable for deferred underwriting fees related to the PNAC IPO payable at closing, and PNAC transaction cost of approximately \$1.52 million for advisory, banking, legal and accounting fee that are expense as part of the business combination transaction. In connection with the reverse recapitalization treatment, transaction costs of \$1.05 million, including legal, financial advisory, and other professional fees related to the Business Combination, are classified as liability originated in the transaction and are reflected as a reduction of additional paid-in capital since those amounts are direct and incremental cost associated with obtaining the capital infusion with PNAC.
- f) Represents the elimination of historical retained earnings of PNAC
- g) Represents the PNCPS compensation according to the advisory agreement between PNCPS and PNAC entered October 2022
- h) Represents PNAC promissory note issued to DBG Global Limited on April 23, 2023

#### **Note 4 – Adjustments to Unaudited Pro Forma Condensed Combined Statement of Operations**

Pro forma adjustments to the attached condensed combined financial statements include the following:

- a) Represents PNAC transaction cost of advisory, banking, legal and accounting that are not able to capitalize as part of the business combination transactions

#### **COMPARATIVE PER SHARE DATA**

The following table sets forth summary historical comparative share and unit information for PNAC for the year ended December 31, 2022, and the unaudited pro forma condensed combined per share information of the combined company for the year ended December 31, 2022 after giving effect to the Business Combination, assuming two redemption scenarios as follows:

- Assuming no redemption scenario: This presentation assumes that no shareholders of PNAC elect to have their PNAC shares redeemed for cash in connection with the Business Combination.
- Assuming maximum redemption scenario: This presentation assumes that the shareholders of PNAC elect to redeem 6,450,000 shares as required by the Business Combination Agreement in the case where all such PNAC Shares are redeemed.

This information is only a summary and should be read together with the summary historical financial information included elsewhere in this proxy statement/prospectus, and the historical financial statements of PNAC and Subco and related notes that are included elsewhere in this proxy statement/prospectus. The unaudited pro forma combined per share information of PNAC is derived from, and should be read in conjunction with, the unaudited pro forma condensed combined financial statements and related notes included elsewhere in this proxy statement/consent solicitation statement/prospectus.

The adjustments presented in the unaudited pro forma combined financial information have been identified and presented to provide relevant information necessary for an understanding of the combined company after giving effect to the Business Combination.

The unaudited pro forma combined share information below does not purport to represent what the actual results of operations or the net income per share would have been had the companies been combined during the periods presented, nor earnings per share for any future date or period. The unaudited pro forma combined book value per share information below does not purport to represent what the value of PNAC would have been had the companies been combined during the periods indicated.

	Historical		Pro Forma Combined	
	Sub Co (noco-noco)	PNAC	No Redemption Scenario	Maximum Redemption Scenario
<b>As of and for the year ended December 31, 2022</b>				
Net (loss) income	(1,629,911)	141,931	(10,692,825)	(10,692,825)
Shareholders' equity (deficit) <sup>(2)</sup>	(1,165,023)	(2,137,314)	43,322,714	(6,382,934)
Book value per share <sup>(1)(2)</sup>	(3.73)	(1.06)	0.31	(0.05)
Net loss per share – basic and diluted Class A Common stock	(5.22)	0.07	(0.08)	(0.08)
PNAC Public Stockholders	—	—	4,912,299	—
PNAC Public Stockholders (“Rights”)	—	—	806,250	806,250
PNAC Initial Stockholders	—	—	2,011,392	2,011,392
The Sellers	—	—	130,560,928	130,560,928
PNCPS Compensation shares	—	—	609,756	609,756
Weighted average Class A Shares outstanding – basic and diluted	\$ —	\$ —	138,900,625	133,988,326
Net loss per share—basic and diluted – redeemable common stock	\$ —	\$ 0.93	—	—
Weighted average shares outstanding—basic and diluted of redeemable common stock	—	4,040,110	—	—
Net loss per share—basic and diluted – non-redeemable common stock	\$ (5.21)	\$ (1.90)	—	—
Weighted average shares outstanding—basic and diluted of non-redeemable common stock	\$ 311,950	1,906,243	—	—

- (1) The historical book value per share for PNAC is calculated by dividing total shareholders' equity, excluding shares subject to possible redemption, by the number of Class A common stock outstanding at the end of the period.
- (2) The pro forma combined book value per share of common stock is computed by dividing total pro forma shareholders' equity (deficit) by the pro forma number of total shares outstanding at the end of the period on a fully diluted net exercise basis.

**Note 5 – The table below is the breakdown of SubCo Unaudited Condensed Statement of Operations for the financial year ended December 31, 2022:**

	SubCo Historical (Unaudited)		
	January 1, 2022 to June 30, 2022	July 1, 2022 to December 31, 2022	Combined
<b>Operating expenses:</b>			
Research and development	\$ 137,412	\$ -	\$ 137,412
Selling, general and administrative expenses	340,046	1,189,696	1,529,742
Franchise tax expenses	-	-	-
Total operating expenses	477,458	1,189,696	1,667,154
Loss from operation	(477,458)	(1,189,696)	(1,667,154)
<b>Other income/(expense)</b>			
Other income	3,427	26,730	30,157
Foreign exchange gain (loss)	37	8,315	8,352
<b>Total other income/(expense)</b>	3,464	35,045	38,509
<b>Loss before income taxes</b>	(473,994)	(1,154,651)	(1,628,645)
Income tax expenses	-	-	-
<b>Net loss</b>	\$ (473,994)	\$ (1,154,651)	\$ (1,628,645)
Foreign currency translation adjustment	14,571	(15,836)	(1,266)
<b>Net comprehensive loss</b>	(459,423)	(1,170,487)	(1,629,911)

## INFORMATION RELATED TO PUBCO

*The information provided below pertains to PubCo prior to the Business Combination. As of the date of this proxy statement/prospectus, PubCo has not conducted any material activities other than those incident to its formation and to the matters related to effectuating the Business Combination, such as the making of certain required SEC filings, the establishment of Merger Sub and New SubCo and the preparation of this proxy statement/prospectus. Upon the consummation of the Business Combination Agreement, PubCo will become the ultimate parent of noco-noco. For information about PubCo's management and corporate governance following the Business Combination, see the section titled "Management of PubCo Following the Business Combination."*

### **Incorporation**

PubCo was incorporated under the laws of Cayman Islands on December 28, 2022, solely for the purpose of effectuating the Business Combination.

PubCo was incorporated with an aggregate share capital of \$50,000 divided into 500,000,000 registered shares of a par value of \$0.0001 per share. One such share is currently issued and outstanding. For descriptions of PubCo Ordinary Shares, please see the section titled "Description of PubCo Securities." At incorporation, its assets consisted of the par value contributed for its sole outstanding share.

PubCo's corporate purpose is unrestricted and PubCo has the full power and authority to carry out any object not prohibited by the Cayman Islands Companies Act or any other law of the Cayman Islands.

PubCo will, immediately after the consummation of the Business Combination, qualify as a foreign private issuer as defined in Rule 3b-4 under the Exchange Act.

PubCo will, immediately after the consummation of the Business Combination, be an "emerging growth company" as defined in the JOBS Act. PubCo will remain an "emerging growth company" until the earliest to occur of (i) the last day of the fiscal year (a) following the fifth anniversary of the closing of the Business Combination, (b) in which PubCo has total annual gross revenue of at least \$1.235 billion or (c) in which PubCo is deemed to be a large accelerated filer, which means the market value of PubCo Ordinary Shares held by non-affiliates exceeds \$700 million as of the last business day of PubCo's prior second fiscal quarter, and (ii) the date on which PubCo issued more than \$1.0 billion in non-convertible debt during the prior three-year period. PubCo intends to take advantage of exemptions from various reporting requirements that are applicable to most other public companies, whether or not they are classified as "emerging growth companies," including, but not limited to, an exemption from the provisions of Section 404(b) of the Sarbanes-Oxley Act requiring that PubCo's independent registered public accounting firm provide an attestation report on the effectiveness of its internal control over financial reporting and reduced disclosure obligations regarding executive compensation.

Even after PubCo no longer qualifies as an "emerging growth company," as long as PubCo continues to qualify as a foreign private issuer under the Exchange Act, PubCo will be exempt from certain provisions of the Exchange Act that are applicable to U.S. domestic public companies, including, but not limited to, the sections of the Exchange Act regulating the solicitation of proxies, consents or authorizations in respect of a security registered under the Exchange Act; the sections of the Exchange Act requiring insiders to file public reports of their stock ownership and trading activities and liability for insiders who profit from trades made in a short period of time; and the rules under the Exchange Act requiring the filing with the SEC of quarterly reports on Form 10-Q containing unaudited financial and other specified information, and current reports on Form 8-K, upon the occurrence of specified significant events. In addition, PubCo will not be required to file annual reports and financial statements with the SEC as promptly as U.S. domestic companies whose securities are registered under the Exchange Act, and are not required to comply with Regulation FD, which restricts the selective disclosure of material information.

### **Memorandum and Articles of Association**

At the consummation of the Business Combination, the Amended PubCo Charter shall be substantially in the form attached to this proxy statement/prospectus as Annex B. See section entitled "Description of PubCo Securities."

**Principal Executive Office**

After the consummation of the Business Combination, the mailing address and principal executive office of PubCo will be 4 Shenton Way, #04-06 SGX Centre II, Singapore 068807 and its telephone number will be (65) 6970 9643.

**Financial Year**

PubCo has no material assets and does not operate any businesses. Accordingly, no financial statements of PubCo have been included in this proxy statement/prospectus.

PubCo's financial year is the calendar year. PubCo's auditor after the consummation of the Business Combination is expected to be Marcum Asia CPAs LLP, located at 7 Penn Plaza, Suite 830, New York, NY 10001.

**Subsidiaries**

Merger Sub is a newly incorporated Delaware corporation and a wholly-owned subsidiary of PubCo. As of the date of this proxy statement/prospectus, Merger Sub has not conducted any material activities other than those incident to its formation and to the matters contemplated by the Business Combination Agreement. Merger Sub will cease to exist after the consummation of the Merger with PNAC pursuant to Business Combination Agreement, with PNAC surviving as a wholly-owned subsidiary of PubCo.

New SubCo is a newly incorporated Singapore private company limited by share and a wholly-owned subsidiary of PubCo. As of the date of this proxy statement/prospectus, New SubCo has not conducted any material activities other than those incident to its formation and to the matters contemplated by the Business Combination Agreement.

**Sole Shareholder**

Prior to the consummation of the Business Combination, the sole shareholder of PubCo is Mr. Dongfeng Wang, the CEO and Chairman of PNAC. Upon the consummation of the Business Combination, PubCo will become a new public company owned by the prior shareholders of PNAC, the prior holders of noco-noco Shares, the prior holders of PNAC Warrants, and the prior holders of PNAC Rights.

**Board of Directors**

Prior to the consummation of the Business Combination, the director of PubCo is Mr. Dongfeng Wang, who is the CEO and Chairman of PNAC. As of the consummation of the Business Combination, the number of directors of PubCo shall be increased to seven persons, Mr. Wang will cease to be a director of PubCo, and Mr. Masataka Matsumura, Ms. Mari Matsushita, Mr. Yuta Akakuma, Mr. Timothy Lai Wah Teo, Mr. Heizo Takenaka and Mr. Jean-Francois Raymond Roger Minier are expected to become the directors of PubCo.

The Nasdaq listing rules permit a foreign private issuer like PubCo to follow the corporate governance practices of its home country. Under the corporate governance practices in the Cayman Islands, among other things, PubCo is not required to have a majority of the board of directors consist of independent directors.

**Legal Proceedings**

As of the date of this proxy statement/prospectus, PubCo was not party to any material legal proceedings. In the future, PubCo may become party to legal matters and claims arising in the ordinary course of business.

**Properties**

PubCo currently does not own or lease any physical property.

**Employees**

PubCo currently has no employees.

## INFORMATION RELATED TO PNAC

Unless the context otherwise requires, all references in this section to the “Company,” “PNAC,” “we,” “us” or “our” refer to PNAC prior to the consummation of the Business Combination.

### Introduction

PNAC is a blank check company incorporated on February 25, 2021, as a Delaware corporation and formed for the purpose of effecting a merger, share exchange, asset acquisition, share purchase, reorganization or similar business combination with one or more businesses, which we refer to throughout this proxy statement/prospectus as our initial Business Combination. Based on its business activities, PNAC is a “shell company” as defined under the Exchange Act, because it has no operations and nominal assets consisting almost entirely of cash.

### Initial Public Offering

The registration statement for PNAC IPO became effective on May 12, 2022. On May 17, 2022, PNAC consummated the PNAC of 6,450,000 PNAC Units which included 450,000 PNAC Units issued upon the partial exercise of the underwriters’ over-allotment option. The PNAC Units were sold at an offering price of \$10.00 per unit, with each PNAC Unit consists of one share of PNAC Class A Common Stock, one half of one PNAC Warrant, and one PNAC Right, generating gross proceeds of \$64,500,000. Simultaneously with the PNAC IPO, PNAC completed the private sale of 398,892 PNAC Private Shares to the Sponsors at a purchase price of \$10.00 per share, generating gross proceeds of \$3,988,920.

Upon the closing of the PNAC IPO and the private placement on May 17, 2022, the proceeds of \$65,790,000 (or \$10.20 per public share) in the aggregate from the IPO and the private placement were placed in a trust account (the “Trust Account”) with Wilmington Trust, N.A. acting as trustee and will be invested only in U.S. government treasury bills with a maturity of 185 days or less or in money market funds meeting certain conditions under Rule 2a-7 under the Investment Company Act of 1940, as amended (the “Investment Company Act”), and that invest only in direct U.S. government treasury obligations. These funds will not be released until the earlier of the completion of the initial business combination or the liquidation due to PNAC’s failure to complete a business combination by May 17, 2023 (or November 17, 2023, if extended) (such date is referred as the “Final Redemption Date”). The proceeds deposited in the Trust Account could become subject to the claims of PNAC’s creditors, if any, which could have priority over the claims of the PNAC Public Stockholders. In addition, interest income earned on the funds in the Trust Account may be released to PNAC to pay its income or other tax obligations. With these exceptions, expenses incurred by PNAC may be paid prior to a business combination only from the net proceeds of the IPO and private placement not held in the Trust Account.

### May 15, 2023 Special Stockholder Meeting

On May 15, 2023, PNAC held a special meeting of stockholders where PNAC stockholders approved the proposal to amend the PNAC’s amended and restated certificate of incorporation to allow PNAC until May 17, 2023 to consummate an initial business combination, and to elect to extend the period to consummate an initial business combination up to six times, each by an additional one-month period, for a total of up to six months to November 17, 2023, by depositing to PNAC’s Trust Account \$125,000 for each one-month extension (each a “Monthly Extension”). On May 17, 2023, PNAC filed a certificate of amendment to the amended and restated certificate of incorporation, effective on the same date, to effectuate the proposal. In connection with the votes to approve the proposal, 1,537,701 PNAC Public Shares were tendered for redemption on May 13, 2023, and were cancelled on May 22, 2023. As of the date of this proxy statement/prospectus, a total of 4,912,299 PNAC Public Shares are issued and outstanding. On May 17, 2023, an aggregate of \$125,000 was deposited into the Trust Account for the PNAC Public Stockholders, resulting in the first Monthly Extension by one month from May 17, 2023 to June 17, 2023 to allow for PNAC to consummate the Business Combination.

### June 2023 Extension

On June 14, 2023, an additional aggregate of \$125,000 was deposited by noco-noco upon request by the sponsors of the Company, into the Trust Account of the Company, as a result of which, the Company has extended the period of time it has to consummate its initial business combination by one month from June 17, 2023 to July 17, 2023. This is the second of the six Monthly Extension permitted under the Existing PNAC Charter.

In connection with the Monthly Extension Payment, the Company issued an unsecured promissory note of \$125,000 (the “June noco-noco Note”) to noco-noco. The June noco-noco Note is non-interest bearing and payable (subject to the waiver against trust provisions) on the earlier of (i) consummation of the Company’s initial business combination and (ii) the date of the liquidation of the Company. The principal balance may be prepaid at any time, at the election of the Company. The holder of the June noco-noco Note has the right, but not the obligation, to convert the Note, in whole or in part, respectively, into private placement shares (the “Working Capital Shares”) of the Company, by providing the Company with written notice of its intention to convert the Note at least two business days prior to the closing of the Company’s initial business combination. The number of Working Capital Shares to be received by the holder in connection with such conversion shall be an amount determined by dividing (x) the sum of the outstanding principal amount payable to the holder, by (y) \$10.00.

### Effecting Our Business Combination

#### Fair Market Value of noco-noco’s Business

Pursuant to Nasdaq listing rules, the initial business combination must occur with one or more target businesses having an aggregate fair market value equal to at least 80% of the value of the funds in the Trust Account (excluding any deferred underwriting discounts and commissions and taxes payable on the income earned on the Trust Account), which PNAC refers to as the 80% test, at the time of the execution of a definitive agreement for its initial Business Combination. If PNAC is no longer listed on Nasdaq, it will not be required to satisfy the 80% test. PNAC will only complete a business combination if the post-transaction company owns or acquires 50% or more of the outstanding voting securities of the target or otherwise acquires a controlling interest in the target sufficient for it not to be required to register as an investment company under the Investment Company Act.

#### Voting Restrictions in Connection with Special Meeting

The PNAC Initial Stockholders have agreed (A) to vote their PNAC Founder Shares, PNAC Private Shares, and any PNAC Public Shares they may own in favor of any proposed business combination, (B) not to propose, or vote in favor of, prior to and unrelated to an initial business combination, an amendment to the Existing PNAC Charter that would affect the substance or timing of PNAC’s redemption obligation to redeem all PNAC Public Shares if PNAC cannot complete an initial business combination by the Final Redemption Date, unless PNAC provides Public Stockholders an opportunity to redeem their PNAC Public Shares in conjunction with any such amendment, (C) not to redeem any PNAC Common Stock they own into the right to receive cash from the Trust Account in connection with a stockholder vote to approve PNAC’s proposed initial business combination or sell any shares to PNAC in any tender offer in connection with its proposed initial business combination, and (D) that the PNAC Founder Shares and PNAC Private Shares shall not participate in any liquidating distribution upon winding up if a Business Combination is not consummated.



### ***Redemption Rights for PNAC Public Stockholders upon Completion of the Business Combination***

PNAC Public Stockholders may redeem all or a portion of their PNAC Public Shares upon consummation of the Business Combination at a per-share price, payable in cash, equal to the aggregate amount then on deposit in the Trust Account calculated as of two business days before the closing of the Business Combination, including interest earned on the funds held in the Trust Account (net of taxes payable), if any, divided by the number of then issued and outstanding PNAC Public Shares, subject to the limitations described herein. The amount in the Trust Account is initially anticipated to be \$10.20 per share. The per share amount we will distribute to investors who properly redeem their shares will not be reduced by the deferred underwriting commissions PNAC will pay to the underwriters of PNAC IPO. The redemption rights will include the requirement that a beneficial holder must identify itself in order to validly redeem its shares. Further, PNAC will not proceed with redeeming our PNAC Public Shares, even if a PNAC Public Stockholder has properly elected to redeem its PNAC Public Shares, if the Business Combination does not close. See the section titled “*Special Meeting of PNAC stockholders—Redemption Rights*” for the procedures to be followed if you wish to redeem your shares for cash.

### ***Limitations on Redemption Rights***

The Existing PNAC Charter provides that in no event will PNAC redeem its PNAC Public Shares in an amount that would cause the net tangible assets of it or the entity that succeeds PNAC as a public company to be less than \$5,000,001 either before or upon closing of an initial business combination (so that it does not then become subject to the SEC’s “penny stock” rules). In the event the aggregate cash consideration it would be required to pay for all PNAC Common Stock that are validly submitted for redemption plus any amount required to satisfy cash conditions pursuant to the terms of the Business Combination exceed the aggregate amount of cash available to PubCo, we will not complete the Business Combination or redeem any shares, and all PNAC Public Shares submitted for redemption will be returned to the holders thereof.

### ***Redemption of PNAC Public Shares and Liquidation if No Business Combination***

The Existing PNAC Charter provides that PNAC will have only until the Final Redemption Date to consummate an initial business combination. If we have not consummated an initial business combination by the Final Redemption Date, we will (i) cease all operations except for the purpose of winding up, (ii) as promptly as reasonably possible but no more than ten business days thereafter subject to lawfully available funds therefor, redeem the PNAC Public Shares, at a per-share price, payable in cash, equal to the aggregate amount then on deposit in the Trust Account including interest earned on the funds held in the Trust Account and not previously released to us to pay our taxes or for working capital purposes (less up to 50,000 of interest to pay dissolution expenses), divided by the number of then outstanding PNAC Public Shares, which redemption will completely extinguish public stockholders’ rights as stockholders (including the right to receive further liquidating distributions, if any), subject to applicable law, and (iii) as promptly as reasonably possible following such redemption, subject to the approval of our remaining stockholders and our board of directors, dissolve and liquidate, subject in each case to our obligations under Delaware law to provide for claims of creditors and the requirements of other applicable law.

PNAC Initial Stockholders have agreed to waive their rights to liquidating distributions from the Trust Account with respect to any PNAC Founder Shares and PNAC Private Shares held by them if we fail to complete our business combination by the Final Redemption Date. However, if any of PNAC Initial Stockholders acquire PNAC Public Shares after the PNAC IPO, they will be entitled to liquidating distributions from the Trust Account with respect to such PNAC Public Shares if we fail to complete our business combination by the Final Redemption Date.

We expect that all costs and expenses associated with implementing our plan of dissolution, as well as payments to any creditors, will be funded from amounts remaining held outside the Trust Account plus up to \$50,000 of funds from the Trust Account available to us to pay dissolution expenses, although we cannot assure you that there will be sufficient funds for such purpose.

For illustrative purposes, as of December 31, 2022, this would have amounted to approximately \$10.34 per issued and outstanding share less any owed but unpaid taxes on the funds in the Trust Account. There are currently no owed but unpaid income taxes on the funds in the Trust Account. However, the proceeds deposited in the Trust Account could become subject to the claims of PNAC's creditors, if any, which would have priority over the claims of PNAC stockholders. Therefore, the per share distribution from the Trust Account in such a situation may be less than originally expected due to such claims. It is expected that the funds to be distributed to PNAC stockholders electing to redeem their shares shall be distributed promptly after the consummation of the Business Combination.

Although we will seek to have all vendors, service providers, prospective target businesses or other entities with which we do business execute agreements with us waiving any right, title, interest and claim of any kind in or to any monies held in the Trust Account for the benefit of our public stockholders, there is no guarantee that they will execute such agreements or even if they execute such agreements that they would be prevented from bringing claims against the Trust Account including but not limited to fraudulent inducement, breach of fiduciary responsibility or other similar claims, as well as claims challenging the enforceability of the waiver, in each case in order to gain an advantage with respect to a claim against our assets, including the funds held in the Trust Account. If any third party refuses to execute an agreement waiving such claims to the monies held in the Trust Account, our management will perform an analysis of the alternatives available to it and will only enter into an agreement with a third party that has not executed a waiver if management believes that such third party's engagement would be significantly more beneficial to us than any alternative. Examples of possible instances where we may engage a third party that refuses to execute a waiver include the engagement of a third-party consultant whose particular expertise or skills are believed by management to be significantly superior to those of other consultants that would agree to execute a waiver or in cases where management is unable to find a service provider willing to execute a waiver.

In addition, there is no guarantee that such entities will agree to waive any claims they may have in the future as a result of, or arising out of, any negotiations, contracts or agreements with us and will not seek recourse against the Trust Account for any reason. Our Sponsors have agreed that it will be liable to us if and to the extent any claims by a third party for services rendered or products sold to us, or a prospective target business with which we have discussed entering into a transaction agreement, reduce the amount of funds in the Trust Account to below (i) \$10.20 per public share or (ii) such lesser amount per public share held in the Trust Account as of the date of the liquidation of the Trust Account, due to reductions in value of the trust assets, in each case net of the amount of interest which may be withdrawn to pay taxes, except as to any claims by a third party who executed a waiver of any and all rights to seek access to the Trust Account and except as to any claims under our indemnity of the underwriters of this offering against certain liabilities, including liabilities under the Securities Act. In the event that an executed waiver is deemed to be unenforceable against a third party, then our sponsor will not be responsible to the extent of any liability for such third party claims. We have not independently verified whether our sponsors have sufficient funds to satisfy its indemnity obligations and believe that our Sponsors' only assets are securities of our company. We have not asked our Sponsors to reserve for such indemnification obligations. Therefore, we cannot assure you that our sponsor would be able to satisfy those obligations. As a result, if any such claims were successfully made against the Trust Account, the funds available for our initial business combination and redemptions could be reduced to less than \$10.20 per public share. In such event, we may not be able to complete our initial business combination, and you would receive such lesser amount per share in connection with any redemption of your PNAC Public Shares. None of our officers will indemnify us for claims by third parties including, without limitation, claims by vendors and prospective target businesses.

Under the DGCL, stockholders may be held liable for claims by third parties against a corporation to the extent of distributions received by them in a dissolution. The pro rata portion of our Trust Account distributed to our public stockholders upon the redemption of our PNAC Public Shares in the event we do not complete our business combination by the Final Redemption Date may be considered a liquidating distribution under Delaware law. If the corporation complies with certain procedures set forth in Section 280 of the DGCL intended to ensure that it makes reasonable provision for all claims against it, including a 60-day notice period during which any third-party claims can be brought against the corporation, a 90-day period during which the corporation may reject any claims brought, and an additional 150-day waiting period before any liquidating distributions are made to stockholders, any liability of stockholders with respect to a liquidating distribution is limited to the lesser of such stockholder's pro rata share of the claim or the amount distributed to the stockholder, and any liability of the stockholder would be barred after the third anniversary of the dissolution.

Furthermore, if the pro rata portion of our Trust Account distributed to our public stockholders upon the redemption of our PNAC Public Shares in the event we do not complete our Business Combination within the Combination Period, is not considered a liquidating distribution under Delaware law and such redemption distribution is deemed to be unlawful, then pursuant to Section 174 of the DGCL, the statute of limitations for claims of creditors could then be six years after the unlawful redemption distribution, instead of three years, as in the case of a liquidating distribution. If we are unable to complete our business combination by the Final Redemption Date, we will: (i) cease all operations except for the purpose of winding up, (ii) as promptly as reasonably possible but not more than ten business days thereafter, redeem the PNAC Public Shares, at a per-share price, payable in cash, equal to the aggregate amount then on deposit in the Trust Account including interest earned on the funds held in the Trust Account and not previously released to us to pay our taxes or for working capital purposes (less up to \$50,000 of interest to pay dissolution expenses), divided by the number of then outstanding PNAC Public Shares, which redemption will completely extinguish public stockholders' rights as stockholders (including the right to receive further liquidating distributions, if any), subject to applicable law, and (iii) as promptly as reasonably possible following such redemption, subject to the approval of our remaining stockholders and our board of directors, dissolve and liquidate, subject in each case to our obligations under Delaware law to provide for claims of creditors and the requirements of other applicable law. Accordingly, it is our intention to redeem our PNAC Public Shares as soon as reasonably possible following our 18th month and, therefore, we do not intend to comply with those procedures. As such, our stockholders could potentially be liable for any claims to the extent of distributions received by them (but no more) and any liability of our stockholders may extend well beyond the third anniversary of such date.

See “Risk Factors—Risks Related to PNAC and the Business Combination.”

## Employees

We currently have three officers. Members of our management team are not obligated to devote any specific number of hours to our matters but they will devote as much of their time as they deem necessary to our affairs and intend to continue doing so until we have completed our initial business combination. The amount of time that our officers or any other members of our management team devotes in any time period may vary based on whether a target business has been selected for our initial business combination and the current stage of the business combination process.

## Officers and Directors

Our officers and directors are as follows:

Name	Age	Position
Dongfeng Wang	46	Chief Executive Officer and Chairman
David Friedman	54	Chief Financial Officer and Director
Weixiong (Jeff) Cheong	41	Chief Operating Officer
Qinyu Wang	51	Director
H. David Sherman	74	Director
Chris Dunn	57	Director

**Mr. Dongfeng Wang**, our Chief Executive Officer and Chairman since our inception, has over 20 years of experience in the has more than a decade of first-hand entrepreneurship in the online music, online magazine, online game distribution, blockchain investment, and digital currency mining industries. In 2013, Mr. Wang joined Young CEO Club, a free entrepreneurship coaching program created by Xiamen Longling Capital Assets Management Co., Ltd. (“Longling Capital”), Innovation Works Holdings Limited and Beijing Zhenge Tiancheng Investment Management Company LTD, to share industry knowledge and experience with and advise Chinese emerging start-ups. In 2011, Mr. Wang joined Longling Capital founded by Mr. Wensheng Cai as a founding partner, which later invested in many well-known Chinese internet companies including 58.com Inc., Zhihu Inc., Meitu Inc., Feiyu Technology International Company Ltd., and Baofeng Group Co., Ltd. In 2009, Mr. Wang co-founded Forgame Group (00484.HK) (“Forgame”), entering the field of online game research and development and distribution. Mr. Wang served as the CEO and Chairman of the Board of Forgame from September 2009 to September 2019. Under his leadership, Group was successfully listed on Hong Kong Stock Exchange in October 2013. Prior to that, Mr. Wang and Mr. Wensheng Cai jointly invested in eMule VeryCD, FlashGet, 4399 Games, Meitu and other enterprises in 2006. In 2004, Mr. Wang founded Beijing Zhi Tong Wu Xian Technology Co., Ltd., or Zcom, an electronic magazine platform in China, and served as the CEO of the company from January 2005 to October 2008. From April 2000 to August 2004, Mr. Wang served as a director of Beijing Flying Network Music Software Research and Development Co. Ltd., a digital music distribution company. Mr. Wang received his Bachelor’s degree from Beijing Construction University, majoring in international trade and global economics, in 1999.

**Mr. David Friedman**, our Chief Financial Officer since our inception and director since May 2022, has over 20 years of experience in strategic management, high technology and artificial intelligence. Since May 2020, he has served as a director of Venti Technologies, a developer of autonomous mobility vehicles designed to improve lives through disrupted transportation, commerce and society. Since August 2019, Mr. Friedman has served as an advisor and coach for ALICE Technologies, a developer of an artificial intelligence platform intended for modern AI and optimization techniques. Since June 2019, Mr. Friedman has served as the CFO of Oyla Inc., a developer of optical sensors designed to permit intelligent machines to perceive and navigate the three-dimensional world around them. Between July 2018 and November 2021, he served as the Executive Chairman of the board of the directors of Ayla Networks, where he served as the CEO from September 2010 to July 2018, a provider of a cloud platform-as-a-service connectivity platform designed to provide the flexibility and modularity to enable rapid changes to practically any type of device, cloud or app environment. Before that, Mr. Friedman served as a Vice President in Business Development & Senior Director of Strategic Marketing Group of ZeroG Wireless from February 2006 to January 2020, a developer of wireless solutions for connecting devices to the Internet. From February 2000 to January 2006, Mr. Friedman served as a strategic account manager of Matrix Semiconductor, a developer of three-dimensional integrated circuits, responsible for all direct/indirect European sales. From May 1997 to February 2000, Mr. Friedman served as a marketing manager of microprocessor pricing group of Intel, one of the world's largest chipmakers designing and manufacturing microprocessors for the global personal computers and data center markets. From January 1993 to July 1995, Mr. Friedman served as a mergers & acquisition analyst at the Chase Bank. Mr. Friedman earned his MBA degree from University of Michigan in 1997 and his Bachelor's degree in history from Colgate University in 1990.

**Mr. Weixiong (Jeff) Cheong**, our Chief Operating Officer since July 2022, has over 15 years of experience in private and public capital markets. Mr. Cheong first joined us after our IPO in May 2022 as a representative of the management to identify business opportunities in Asia, before assuming the position of Chief Operating Officer in July 2022. Since January 2022, Mr. Cheong has also served as the Chief Operating Officer for Blue World Acquisition Corporation (Nasdaq: BWA), a special purpose acquisition company. Previously, between November 2015 and March 2022, Mr. Cheong has served as a director at Fortune Asia Long Short Fund, an investment fund. Since November 2011, Mr. Cheong has served as a director at Longfor Pte Ltd., a real estate developer in Singapore. Since August 2009, Mr. Cheong has served as the chief executive officer at Sinjia Land Ltd. (SGX: 5HH), a property development and hospitality management company. From April 2014 to May 2020, Mr. Cheong served as the chairman at CapAllianz Holdings Ltd (former name CWX Global Ltd) (SGX: 594), a company focusing on investment and oil exploration business. Mr. Cheong received a Master's degree of business administration at Singapore Management University in June 2017. He also has passed the exam of Capital Markets and Financial Advisory Services ("CMFAS") in Module 1 (December 2003), Module 4A (Rules and Regulations for Advising on Corporate Finance, June 2005), Module 5 (Rules And Regulations for Financial Advisory Services, January 2004), Module 6 (January 2004), and Module 8 (Collective Investment Schemes, February 2004). Mr. Cheong completed the program of Executive Skills for Board Members in Challenging Times in 2011 and obtained SMU-SID Executive Certificates in Directorship in 2012 at Singapore Management University.

**Ms. Qinyu Wang** has served as an independent director since May 2022. Ms. Wang has over 20 years of experience in e-commerce and risk management. From February 2017 to present, Ms. Wang serves as a strategic consultant of Zhejiang Yi Gao Cultural & Creative Co. Ltd, providing strategic consultation to executives. From January 2016 to January 2017, Ms. Wang served as a Co-Founder of Hangzhou TaoData Co., Ltd., a provider of data analytics services using automated machine learning engines that performs analysis, model deployment and model updating. From October 2010 to December 2015, Ms. Wang served as a senior director of Alibaba Group, one of the largest retailers and e-commerce companies globally. From February 2006 to September 2008, Ms. Wang served as a Vice President of HSBC, one of the largest banks in the world with 40 million customers worldwide. Ms. Wang served as a Vice President of JP Morgan Chase between September 2000 and February 2006, involving in risk and information management. Ms. Wang earned her PhD. degree in Engineering from University of Pittsburgh and her Bachelor's degree in Engineering from Tsinghua University.

**Mr. H. David Sherman** has served as an independent director since May 2022. Mr. Sherman is a professor who has over 30 years of academic and professional experience in accounting and auditing. Mr. Sherman has been a professor at Northeastern University since 1984, specializing in, among other areas, financial and management accounting, global financial statement analysis and contemporary accounting issues. Mr. Sherman has served as Trustee and Chair of Finance Committee for American Academy of Dramatic Arts, the oldest English language acting school in the world, since January 2014, and as Board member and Treasurer for D-Tree International, a non-profit organization that develops and supports electronic clinical protocols to enable health care workers worldwide to deliver high quality care since July 2010. From 2020 to present, Mr. Sherman serves as a director and audit committee chair of China Liberal Education Holdings Limited, an educational service provider operating in China. From 2020 to present, Mr. Sherman serves as Board and Audit Committee Chair of Skillful Craftsman Education Technology Limited, a provider of online education and technology services in China. From 2019 to present, Mr. Sherman serves as a director and a member of Audit Committee of NUVVE Holdings Corp. (Nasdaq: NVVE), previously known as Newborn Acquisition Corporation (Nasdaq: NBAC), a blank check company until March 2021 when it consummated its business combination. From January 2012 to November 2014, Mr. Sherman served as the Chair of the Audit Committee and Compensation Committee of Agfeed Corporation (OTC: FEED), a hog production business. From February 2011 to May 2016, Mr. Sherman served as the Chair of the Audit Committee of Kingold Jewelry Inc. (Nasdaq: KGJI), a manufacturer of 24K gold jewelry in Wuhan, China. Mr. Sherman was previously on the faculty of the Sloan School of Management at Massachusetts Institute of Technology (MIT) from 1980 to 1995 and also, among other academic appointments, held an adjunct professorship at Tufts Medical School and was a visiting professor at Harvard Business School (2015). From 2004 to 2005, Professor Sherman was an Academic Fellow at the U.S. Securities and Exchange Commission in the Division of Corporate Finance's Office of Chief Accountant. Mr. Sherman earned his Doctorate Degree in Accounting and Accountability Systems from Harvard Business School in 1981. Mr. Sherman earned his Master's Degree in Business Administration and Control of Finance from Harvard Business School in 1971 and his Bachelor's degree in Economics from Brandeis University in 1969. He was Cum Laude with Honors in Economics. Mr. Sherman is a CPA certificate holder. Mr. Sherman served as a director of Lakeshore Acquisition I Corp., a special purpose acquisition company listed on Nasdaq, between June 2021 and December 2022, and has served as a director of Lakeshore Acquisition II Corp., another special purpose acquisition company listed on Nasdaq, since March 2022.

**Mr. Chris Dunn** has served as an independent director since May 2022. Mr. Dunn is a partner of Mission Peak Capital, where he is responsible for managing real estate investments. Prior to that, Mr. Dunn served as a managing director of Commercial Real Estate Group at Deutsche Bank between 2001 and 2012, where he managed a group of bankers in sourcing, pricing, structuring, and closing of performing and distressed commercial real estate loans. From 2000 to 2001, he worked as a principal in the real estate finance division at Band of America Securities LLC. Mr. Dunn also served as a director of Structured Finance – Commercial Real Estate Division at Standard & Poor's between 1997 and 2000. Mr. Dunn received his Bachelor's degree in Business Administration from Boston University.

### **Number and Terms of Officers and Directors**

Our board consists of five directors. Our board of directors is divided into three classes with only one class of directors being elected in each year and each class (except for those directors appointed prior to our first annual meeting of stockholders) serving a three-year term. The term of office of the first class of directors, consisting of Mr. H David Sherman, the chairman of audit committee, will expire at our first annual meeting of stockholders. The term of office of the second class of directors, consisting of Ms. Qinyu Wang and Mr. Chris Dunn, the two other independent directors, will expire at the second annual meeting of stockholders. The term of office of the third class of directors, consisting of Mr. Dongfeng Wang and Mr. David Friedman, our executive directors, will expire at the third annual meeting of stockholders. We may not hold an annual meeting of stockholders until after we consummate our initial business combination. Holders of our PNAC Public Shares will have no right to vote on the election of directors during such time. These provisions of our amended and restated certificate of incorporation may only be amended by the vote of at least 90% of our issued and outstanding common stock entitled to vote thereon. As a result, you will not have any influence over the election of directors prior to our initial business combination.

Our officers are appointed by the board of directors and serve at the discretion of the board of directors, rather than for specific terms of office. Our board of directors is authorized to appoint persons to the offices set forth in our bylaws as it deems appropriate. Our bylaws provide that our officers may consist of one or more Chairmen of the Board, one or more Chief Executive Officer, a President, a Chief Financial Officer, Vice Presidents, Secretary, Treasurer, Assistant Secretary and such other offices as may be determined by the board of directors.

### **Director Independence**

Nasdaq listing standards require that a majority of our board of directors be independent. An “independent director” is defined generally as a person other than an officer or employee of the company or its subsidiaries or any other individual having a relationship which in the opinion of the company’s board of directors, would interfere with the director’s exercise of independent judgment in carrying out the responsibilities of a director. Our board of directors has determined that Ms. Wang, Mr. Sherman, and Mr. Dunn are “independent directors” as defined in the Nasdaq listing standards and applicable SEC rules. Our audit committee is entirely composed of independent directors meeting Nasdaq’s additional requirements applicable to members of the audit committee. Our independent directors will have regularly scheduled meetings at which only independent directors are present.

### **Committees of the Board of Directors**

Our board of directors will have two standing committees: an audit committee and a compensation committee. Subject to phase-in rules and a limited exception, the rules of Nasdaq and Rule 10A-3 of the Exchange Act require that the audit committee of a listed company be comprised solely of independent directors, and the rules of Nasdaq require that the compensation committee of a listed company be comprised solely of independent directors.

#### ***Audit Committee***

Prior to the consummation of this offering, we have established an audit committee of the board of directors. Ms. Qinyu Wang, Mr. H. David Sherman, and Mr. Chris Dunn serve as members of our audit committee, with Mr. Sherman serving as the Chairman of the audit committee. Under the Nasdaq listing standards and applicable SEC rules, we are required to have at least three members of the audit committee, all of whom must be independent, subject to certain phase-in provisions. Each such person meets the independent director standard under Nasdaq listing standards and under Rule 10-A-3(b)(1) of the Exchange Act.

Each member of the audit committee is financially literate and our board of directors has determined that Mr. Sherman qualifies as an “audit committee financial expert” as defined in applicable SEC rules.

We have adopted an audit committee charter, which details the principal functions of the audit committee, including:

- the appointment, compensation, retention, replacement, and oversight of the work of the independent auditors and any other independent registered public accounting firm engaged by us;
- pre-approving all audit and permitted non-audit services to be provided by the independent auditors or any other registered public accounting firm engaged by us, and establishing pre-approval policies and procedures;
- reviewing and discussing with the independent auditors all relationships the auditors have with us in order to evaluate their continued independence;
- setting clear hiring policies for employees or former employees of the independent auditors;
- setting clear policies for audit partner rotation in compliance with applicable laws and regulations;

- obtaining and reviewing a report, at least annually, from the independent auditors describing (i) the independent auditor's internal quality-control procedures and (ii) any material issues raised by the most recent internal quality-control review, or peer review, of the audit firm, or by any inquiry or investigation by governmental or professional authorities within the preceding five years respecting one or more independent audits carried out by the firm and any steps taken to deal with such issues;
- reviewing and approving any related party transaction required to be disclosed pursuant to Item 404 of Regulation S-K promulgated by the SEC prior to us entering into such transaction; and
- reviewing with management, the independent auditors, and our legal advisors, as appropriate, any legal, regulatory or compliance matters, including any correspondence with regulators or government agencies and any employee complaints or published reports that raise material issues regarding our financial statements or accounting policies and any significant changes in accounting standards or rules promulgated by the Financial Accounting Standards Board, the SEC or other regulatory authorities.

#### ***Compensation Committee***

Prior to the consummation of this offering, we have established a compensation committee of the board of directors. Ms. Qinyu Wang, Mr. H. David Sherman, and Mr. Chris Dunn serve as members of our compensation committee, with Ms. Qinyu Wang serving as the chairwoman of the compensation committee. Under the Nasdaq listing standards and applicable SEC rules, we are required to have at least two members of the compensation committee, all of whom must be independent, subject to certain phase-in provisions. Each such person meets the independent director standard under Nasdaq listing standards applicable to members of the compensation committee.

We have adopted a compensation committee charter, which details the principal functions of the compensation committee, including:

- reviewing and approving on an annual basis the corporate goals and objectives relevant to our Chief Executive Officer's compensation, evaluating our Chief Executive Officer's performance in light of such goals and objectives and determining and approving the remuneration (if any) of our Chief Executive Officer based on such evaluation;
- reviewing and approving on an annual basis the compensation of all of our other officers;
- reviewing on an annual basis our executive compensation policies and plans;
- implementing and administering our incentive compensation equity-based remuneration plans;
- assisting management in complying with our proxy statement and annual report disclosure requirements;
- approving all special perquisites, special cash payments and other special compensation and benefit arrangements for our officers and employees;
- if required, producing a report on executive compensation to be included in our annual proxy statement; and
- reviewing, evaluating and recommending changes, if appropriate, to the remuneration for directors.

Notwithstanding the foregoing, as indicated above, other than reimbursement of expenses, no compensation of any kind, including finders, consulting or other similar fees, will be paid to any of our existing stockholders, officers, directors or any of their respective affiliates, prior to, or for any services they render in order to complete the consummation of a business combination although we may consider cash or other compensation to officers or advisors we may hire subsequent to this offering to be paid either prior to or in connection with our initial business combination. Accordingly, it is likely that prior to the consummation of an initial business combination, the compensation committee will only be responsible for the review and recommendation of any compensation arrangements to be entered into in connection with such initial business combination.

The charter also provides that the compensation committee may, in its sole discretion, retain or obtain the advice of a compensation consultant, legal counsel or other adviser and will be directly responsible for the appointment, compensation and oversight of the work of any such adviser. However, before engaging or receiving advice from a compensation consultant, external legal counsel or any other adviser, the compensation committee will consider the independence of each such adviser, including the factors required by Nasdaq and the SEC.

### **Director Nominations**

We do not have a standing nominating committee. In accordance with Rule 5605(e)(2) of the Nasdaq Rules, a majority of the independent directors may recommend a director nominee for selection by the board of directors. The board of directors believes that the independent directors can satisfactorily carry out the responsibility of properly selecting or approving director nominees without the formation of a standing nominating committee. As there is no standing nominating committee, we do not have a nominating committee charter in place.

The board of directors will also consider director candidates recommended for nomination by our stockholders during such times as they are seeking proposed nominees to stand for election at the next annual meeting of stockholders (or, if applicable, a special meeting of stockholders). Our stockholders that wish to nominate a director for election to our board of directors should follow the procedures set forth in our bylaws.

We have not formally established any specific, minimum qualifications that must be met or skills that are necessary for directors to possess. In general, in identifying and evaluating nominees for director, our board of directors considers educational background, diversity of professional experience, knowledge of our business, integrity, professional reputation, independence, wisdom, and the ability to represent the best interests of our stockholders.

### **Compensation Committee Interlocks and Insider Participation**

None of our officers currently serves, and in the past year have not served, as a member of the compensation committee of any entity that has one or more officers serving on our board of directors.

### **Code of Ethics**

Prior to the consummation of this offering, we have adopted a Code of Ethics applicable to our directors, officers and employees. You will be able to review these documents by accessing our public filings at the SEC's web site at [www.sec.gov](http://www.sec.gov). In addition, a copy of the Code of Ethics will be provided without charge upon request from us. We intend to disclose any amendments to or waivers of certain provisions of our Code of Ethics in a Current Report on Form 8-K. See the section of this prospectus entitled "Where You Can Find Additional Information."

### **Conflicts of Interest**

Although we do not believe any conflict currently exists between us and our Sponsors, directors and officers (the "founders"), affiliates of our founders may compete with us for acquisition opportunities. If such entities decide to pursue an opportunity, we may be precluded from procuring such opportunity. In addition, investment ideas generated within our founders may be suitable for both of us and for an affiliate of founders and may be directed to such entity rather than to us. Neither our founders nor members of our management team who are also employed by or affiliated with our founders will have any obligation to present us with any opportunity for a potential business combination of which they become aware, unless presented to such member specifically in his or her capacity as an officer or director of the company. Our founders and/or our management team, in their capacities as employees or affiliates of our founders or in their other endeavors, may be required to present potential business combinations to future founders' affiliates or third parties, before they present such opportunities to us.

Each of our officers and directors presently has, and any of them in the future may have additional, fiduciary or contractual obligations to other entities pursuant to which such officer or director is or will be required to present business combination opportunities to such entity. Accordingly, in the future, if any of our officers or directors becomes aware of a business combination opportunity which is suitable for an entity to which he or she has then-current fiduciary or contractual obligations, he or she will honor his or her fiduciary or contractual obligations to present such opportunity to such entity. We do not believe, however, that any fiduciary duties or contractual obligations of our officers arising in the future would materially undermine our ability to complete our business combination. Our amended and restated certificate of incorporation contain provisions waiving the corporate opportunities doctrine on an ongoing basis, providing that we renounce any interest or expectancy in, or in being offered an opportunity to participate in, any potential transaction or matter which may be a corporate opportunity for us, our Sponsors and their affiliates, about which a director of PNAC and/or officer of PNAC who is director, officer or member of the Sponsors or their affiliate acquires knowledge. We are not aware of any such corporate opportunities not being offered to us and does not believe that waiver of the corporate opportunities doctrine has created any conflicts of interest, has affected our search for an acquisition target, or will materially affect our ability to complete a Business Combination.



Our officer or director may become an officer or director of any other special purpose acquisition company with a class of securities registered under the Securities Exchange Act of 1934, as amended, or the Exchange Act, even before we enter into a definitive agreement regarding our initial Business Combination or we have failed to complete our initial Business Combination within the Combination Period.

When considering the PNAC Board's recommendation to vote in favor of approving the Business Combination Proposal and the Governing Documents Proposal, PNAC stockholders should keep in mind that the Sponsors and PNAC's directors and executive officers, have interests in such proposals that are different from, or in addition to (and which may conflict with), those of PNAC stockholders generally. These interests include, among other things, the interests listed below:

- the beneficial ownership by the Sponsors of an aggregate of 1,474,000 Founder Shares and 398,892 Private Shares, which would become worthless if PNAC does not complete a business combination within the applicable time period, as the Sponsor has waived any right to redemption with respect to these shares. The Sponsors paid an aggregate of approximately \$25,000, or \$0.017 per share, for the Founders Shares and \$3,988,920, or \$10.00 per share, for the Private Shares. Such shares of PNAC Class A Common Stock held by the Sponsors have an aggregate market value of approximately \$ , based on the closing price of PNAC Class A Common Stock on the Record Date, resulting in a theoretical gain of \$ (or \$ per share);
- Mr. Dongfeng Wang, PNAC'S Chairman and Chief Executive Officer, is the manager of Prime Number Acquisition LLC, a Sponsor of PNAC, and as such may be deemed to have sole voting and investment discretion with respect to the shares of PNAC Class A Common Stock held by Prime Number Acquisition LLC, including 1,383,700 Founder Shares and 349,032 Private Shares as described above. In addition, Mr. Wang directly holds 45,000 Founder Shares, which would become worthless if PNAC does not complete a business combination within the applicable time period, as Mr. Wang has waived any right to redemption with respect to these shares. For the shares directly held by Mr. Wang, Mr. Wang paid an aggregate of approximately \$652.174, or \$0.017 per share, for the Founders Shares. Such shares of PNAC Class A Common Stock directly held by Mr. Wang have an aggregate market value of approximately \$ , based on the closing price of PNAC Class A Common Stock on the Record Date, resulting in a theoretical gain of \$ (or \$ per share). Such shares of PNAC Class A Common Stock held by Prime Number Acquisition LLC have an aggregate market value of approximately \$ , based on the closing price of PNAC Class A Common Stock on the Record Date, resulting in a theoretical gain of \$ (or \$ per share);
- Mr. David Friedman, PNAC'S Chief Financial Officer and director, directly holds 30,000 Founder Shares, which would become worthless if PNAC does not complete a business combination within the applicable time period, as Mr. Friedman has waived any right to redemption with respect to these shares. For the shares directly held by Mr. Friedman, Mr. Friedman paid an aggregate of approximately \$434.783, or \$0.017 per share, for the Founders Shares. Such shares of PNAC Class A Common Stock directly held by Mr. Friedman have an aggregate market value of approximately \$ , based on the closing price of PNAC Class A Common Stock on the Record Date, resulting in a theoretical gain of \$ (or \$ per share);
- Mr. Weixong (Jeff) Cheong, PNAC'S Chief Operating Officer, is the sole director and member of DBG Global Limited. DBG Global Limited is a member of Prime Number Acquisition LLC, a Sponsor of PNAC, and Mr. Cheong, as the sole director and member of DBG Global Limited, may be deemed to have beneficial ownership over 447,561 shares of PNAC Class A Common Stock for which Prime Number Acquisition LLC is the record holder, including 336,565 Founder Shares and 110,996 Private Shares. Such shares of PNAC Class A Common Stock would become worthless if PNAC does not complete a business combination within the applicable time period, as Prime Number Acquisition LLC has waived any right to redemption with respect to these shares. Such shares of PNAC Class A Common Stock held by Prime Number Acquisition LLC have an aggregate market value of approximately \$ , based on the closing price of PNAC Class A Common Stock on the Record Date, resulting in a theoretical gain of \$ (or \$ per share);
- each of the three independent directors of PNAC holds 15,000 Founder Shares, which would become worthless if PNAC does not complete a business combination within the applicable time period, as the independent directors have waived any right to redemption with respect to these shares. Each independent director of PNAC paid approximately \$217.391, or \$0.017 per share for such 15,000 Founder Shares. Such 15,000 Founder Shares held by each independent director have an aggregate market value of approximately \$ , based on the closing price of PNAC Class A Common Stock on the Record Date, resulting in a theoretical gain of \$ (or \$ per share);
- in order to finance transaction costs in connection with an intended initial business combination, the Sponsors, affiliates of the Sponsors, PNAC's directors and officers, may, but are not obligated to, loan PNAC funds as may be required. Additionally, if we extend the time available to us to complete our business combination, our Sponsors, their affiliates or designee may deposit \$645,000, for each three-month extension for up to two times to extend the time for us to complete our business combination. If PNAC completes the Business Combination, PNAC would repay such loaned amounts out of the proceeds of the Trust Account released to PNAC. Otherwise, such loans would be repaid only out of funds held outside the Trust Account. In the event that the Business Combination does not close, PNAC may use a portion of the working capital held outside the Trust Account to repay such loaned amounts but no proceeds from the Trust Account would be used to repay such loaned amounts. Up to \$3,000,000 of such loans may be convertible into the Working Capital Shares, at a price of \$10.00 per share at the option of the lender. As of the date hereof, PNAC had no outstanding balance under the working capital loans as evidenced by the Notes accordingly. In the event that PNAC fails to complete a business combination by May 16, 2023 (or November 16, 2023, if extended), it is uncertain if PNAC has sufficient working capital held outside the Trust Account to fully repay any outstanding loans, and the Sponsors may be eventually held liable for PNAC's liabilities pursuant to its certain indemnification obligations;
- the fact that the PNAC Initial Stockholders (including the Sponsors, certain PNAC officers and directors) have agreed not to redeem any PNAC Founder Shares and PNAC Private Shares held by them in connection with a shareholder vote to approve the proposed Business Combination;
- the fact that given the very low purchase price (of \$25,000 in aggregate) that the PNAC Initial Stockholders paid for the PNAC Founder Shares as compared to the price of the PNAC Common Stock sold in PNAC IPO, the PNAC Initial Stockholders may earn a positive rate of return on their investment even if the PubCo Ordinary Shares trade below the price initially paid for the PNAC Common Stock in the PNAC IPO and the PNAC Public Stockholder may experience a negative rate of return following the completion of the Business Combination;
- the fact that the PNAC Initial Stockholders have agreed to waive their rights to liquidating distributions from the Trust Account with respect to any PNAC Founder Shares and PNAC Private Shares held by them if PNAC fails to complete an initial business combination by the Final Redemption Date. As a result of waiving liquidating distributions, if PNAC fails to complete an initial business combination by the Final Redemption Date, the Sponsors would lose \$3,988,920 for the purchase of PNAC Private Shares, and the PNAC Initial Stockholders would lose \$25,000 for the purchase of the PNAC Founder Shares, and thus they (other than the PNAC Initial Stockholders that acquired the PNAC Founder Shares for nominal consideration) would incur substantial loss of investment and will not be reimbursed for any out-of-pocket expenses;

- the fact that the PNAC Initial Stockholders may be incentivized to complete the Business Combination, or an alternative initial business combination with a less favorable company or on terms less favorable to stockholders, rather than to liquidate, in which case the PNAC Initial Stockholders would lose their entire investment. As a result, the PNAC Initial Stockholders may have a conflict of interest in determining whether noco-noco is an appropriate business with which to effectuate a business combination and/or in evaluating the terms of the Business Combination;
- the fact that pursuant to the Registration Rights Agreement, the PNAC Initial Stockholders can demand that PubCo register its registrable securities under certain circumstances and will also have piggyback registration rights for these securities in connection with certain registrations of securities that PubCo undertakes;
- the continued indemnification of PNAC's directors and officers and the continuation of PNAC's directors' and officers' liability insurance after the Business Combination (i.e. a "tail policy");
- the fact that if the Trust Account is liquidated, including in the event PNAC is unable to complete an initial business combination by the Final Redemption Date, the Sponsors have agreed to indemnify PNAC to ensure that the proceeds in the Trust Account are not reduced below \$10.20 per public share, or such lesser per public share amount as is in the Trust Account on the liquidation date, by the claims of prospective target businesses with which PNAC has entered into a letter of intent, confidentiality or other similar agreement or a business combination agreement or claims of any third party for services rendered or products sold to PNAC, but only if such a vendor or target business has not executed a waiver of any and all rights to seek access to the Trust Account; and
- the fact that the PNAC Initial Stockholders, are, or may in the future become, affiliated with entities that are engaged in a similar business to PNAC. The PNAC Initial Stockholders are not prohibited from sponsoring, or otherwise becoming involved with, any other blank check companies prior to completing the Business Combination. Accordingly, if any of PNAC's officers or directors becomes aware of a business combination opportunity that is suitable for an entity to which he or she has then current fiduciary or contractual obligations, he or she will honor his or her fiduciary or contractual obligations to present such Business Combination opportunity to such entity, subject to their fiduciary duties under DGCL. In addition, to the fullest extent permitted by applicable laws, the Existing PNAC Charter waives certain applications of the doctrine of corporate opportunity in some circumstances where the application of any such doctrine would conflict with any fiduciary duties or contractual obligations they may have as of the date of the Existing PNAC Charter or in the future, and PNAC will renounce any expectancy that any of the directors or officers of PNAC will offer any such corporate opportunity of which he or she may become aware to PNAC. PNAC does not believe that the pre-existing fiduciary duties or contractual obligations of its officers and directors materially impacted its search for an acquisition target. Further, PNAC does not believe that the waiver of the application of the corporate opportunity doctrine in the Existing PNAC Charter had any impact on its search for a potential business combination target.

The PNAC Initial Stockholders have agreed to, among other things, vote all of their PNAC Founder Shares and PNAC Private Shares in favor of the proposals being presented at the Special Meeting and waive their redemption rights with respect to their PNAC Common Stock in connection with the consummation of the Business Combination. As of the date of this proxy statement/prospectus, the PNAC Initial Stockholders own approximately 29.05% of the issued and outstanding shares of PNAC Common Stock.

#### **Limitation on Liability and Indemnification of Officers and Directors**

Our amended and restated certificate of incorporation provides that our officers and directors will be indemnified by us to the fullest extent authorized by Delaware law, as it now exists or may in the future be amended. In addition, our amended and restated certificate of incorporation provides that our directors will not be personally liable for monetary damages to us or our stockholders for breaches of their fiduciary duty as directors, unless they violated their duty of loyalty to us or our stockholders, acted in bad faith, knowingly or intentionally violated the law, authorized unlawful payments of dividends, unlawful stock purchases or unlawful redemptions, or derived an improper personal benefit from their actions as directors.

We have entered into agreements with our officers and directors to provide contractual indemnification in addition to the indemnification provided for in our amended and restated certificate of incorporation. Our bylaws also will permit us to secure insurance on behalf of any officer, director or employee for any liability arising out of his or her actions, regardless of whether Delaware law would permit such indemnification. We have purchased a policy of directors' and officers' liability insurance that insures our officers and directors against the cost of defense, settlement or payment of a judgment in some circumstances and insures us against our obligations to indemnify our officers and directors.

These provisions may discourage stockholders from bringing a lawsuit against our directors for breach of their fiduciary duty. These provisions also may have the effect of reducing the likelihood of derivative litigation against officers and directors, even though such an action, if successful, might otherwise benefit us and our stockholders. Furthermore, a stockholder's investment may be adversely affected to the extent we pay the costs of settlement and damage awards against officers and directors pursuant to these indemnification provisions.

We believe that these provisions, the directors' and officers' liability insurance and the indemnity agreements are necessary to attract and retain talented and experienced officers and directors.

### **Legal Proceedings**

To the knowledge of our management team, there is no material litigation currently pending or contemplated against us, any of our officers or directors in their capacity as such, or against any of our property.

### **Properties**

Our executive office is located at c/o 1129 Northern Blvd., Suite 404, Manhasset, New York, 11030 and our telephone number is +1 (347) 329-1575. Starting the effectiveness of the PNAC IPO, we have agreed to pay Sponsor A a monthly fee of an aggregate of \$10,000 for office space, administrative and shared personnel support services. This arrangement will terminate upon the earlier of (a) completion of a Business Combination or (b) twelve months after the completion of the IPO on May 17, 2024. We consider our current office space, combined with the other office space otherwise available to our executive officers, adequate for our current operations.

### **Competition**

In identifying, evaluating and selecting a target business for the Business Combination, we encountered intense competition from other entities having a business objective similar to ours, including other blank check companies, private equity groups and leveraged buyout funds, and operating businesses seeking strategic acquisitions. Many of these entities are well established and have extensive experience identifying and effecting business combinations directly or through affiliates. Moreover, many of these competitors possess greater financial, technical, human and other resources than us. Our ability to acquire larger target businesses is limited by our available financial resources. This inherent limitation gives others an advantage in pursuing the acquisition of a target business. Furthermore, our obligation to pay cash in connection with our public shareholders who exercise their redemption rights may reduce the resources available to us for the Business Combination.

### **Periodic Reporting and Financial Information**

PNAC Class A Common Stock are registered under the Exchange Act, and we have reporting obligations, including the requirement that we file annual, quarterly and current reports with the SEC. In accordance with the requirements of the Exchange Act, our annual reports will contain financial statements audited and reported on by our independent registered public accounting firm.

We will be required to evaluate our internal control procedures for the fiscal year ending December 31, 2022 as required by the Sarbanes-Oxley Act. Only in the event we are deemed to be a large accelerated filer or an accelerated filer and no longer qualify as an emerging growth company, will we be required to have our internal control procedures audited. A target company may not be in compliance with the provisions of the Sarbanes-Oxley Act regarding adequacy of their internal controls. The development of the internal controls of any such entity to achieve compliance with the Sarbanes-Oxley Act may increase the time and costs necessary to complete any such acquisition.

We are an "emerging growth company," as defined in Section 2(a) of the Securities Act, as modified by the JOBS Act. As such, we are eligible to take advantage of certain exemptions from various reporting requirements that are applicable to other public companies that are not "emerging growth companies" including, but not limited to, not being required to comply with the auditor attestation requirements of Section 404 of the Sarbanes-Oxley Act, reduced disclosure obligations regarding executive compensation in our periodic reports and proxy statements, and exemptions from the requirements of holding a non-binding advisory vote on executive compensation and shareholder approval of any golden parachute payments not previously approved. If some investors do find our securities less attractive as a result, there may be a less active trading market for our securities and the prices of our securities may be more volatile.

In addition, Section 107 of the JOBS Act also provides that an "emerging growth company" can take advantage of the extended transition period provided in Section 7(a)(2)(B) of the Securities Act for complying with new or revised accounting standards. In other words, an "emerging growth company" can delay the adoption of certain accounting standards until those standards would otherwise apply to private companies. We intend to take advantage of the benefits of this extended transition period. We will remain an emerging growth company until the earlier of (i) the last day of the fiscal year (a) following the fifth anniversary of the completion of our initial public offering, (b) in which we have total annual gross revenue of at least \$1.235 billion, or (c) in which we are deemed to be a large accelerated filer, which means the market value of our ordinary shares that is held by non-affiliates exceeds \$700 million as of the prior June 30<sup>th</sup>, and (ii) the date on which we have issued more than \$1.0 billion in non-convertible debt securities during the prior three-year period. References herein to "emerging growth company" shall have the meaning associated with it in the JOBS Act.

## MANAGEMENT’S DISCUSSION AND ANALYSIS OF FINANCIAL CONDITION AND RESULTS OF OPERATION OF PNAC

*The following discussion and analysis of PNAC’s financial condition and results of operations should be read in conjunction with PNAC’s audited consolidated financial statements and the related notes to those statements included elsewhere in this proxy statement/prospectus. In addition to historical consolidated financial information, the following discussion contains forward-looking statements that involve risks and uncertainties. PNAC’s actual results could differ materially from those discussed in the forward-looking statements as a result of many factors, including those factors set forth in the sections titled “Risk Factors” and “Forward-Looking Statements”, which you should review for a discussion of some of the factors that could cause actual results to differ materially from the results described in or implied by the forward-looking statements contained in the following discussion and analysis and elsewhere in this proxy statement/prospectus.*

### Overview

Prime Number Acquisition I Corp. (“we”, “the Company” or “PNAC”) is a blank check company incorporated as a Delaware corporation on February 25, 2021 formed for the purpose of effecting a merger, capital stock exchange, asset acquisition, stock purchase, reorganization or similar business combination with one or more businesses (collective, our “initial business combination”).

We expect to continue to incur significant costs towards the Closing of the Business Combination (defined below). We cannot assure you that our plans to complete the Business Combination will be successful.

On May 17, 2022, we consummated the initial public offering (the “PNAC IPO”) of 6,450,000 units, each consisting of one PNAC Class A Common Stock, one-half of one PNAC Warrant, and one PNAC Right. Simultaneously with the closing of the PNAC IPO, we consummated the private placement (the “Private Placement”) of 398,892 PNAC Private Shares. Following the closings of the PNAC IPO and the Private Placement on May 17, 2022, a total of \$65,790,000 (or \$10.20 per share) was placed in the Trust Account.

On June 30, 2022, we announced that holders of PNAC Units may elect to separately trade PNAC Class A Common Stock, PNAC Warrants and PNAC Rights included in the PNAC Units, commencing on or about July 6, 2022.

The PNAC Class A Common Stock, PNAC Warrants and PNAC Rights are traded on the Nasdaq Global Market under the symbols “PNAC”, “PNACW”, and “PNACR” respectively. PNAC Units not separated are traded on Nasdaq under the symbol “PNACU”.

### Recent Development

#### *Entry into Business Combination Agreement*

On December 29, 2022, we, Prime Number Merger Sub Inc. (“Merger Sub”), a Delaware corporation established for the purpose to become a wholly-owned subsidiary of a newly incorporated exempted Cayman Islands company (“PubCo”) prior to the Business Combination (as defined below), NOCO-NOCO PTE. LTD. (“noco-noco”) and certain shareholders of noco-noco collectively holding a controlling interest (together with other shareholders of noco-noco subsequently joining the transactions, the “Sellers”) entered into a Business Combination Agreement (the “Business Combination Agreement”). Capitalized terms used and not otherwise defined herein have the definitions assigned to such terms in the Business Combination Agreement.

Pursuant to the Business Combination Agreement, among other things, in accordance with the General Corporation Law of the State of Delaware, as amended (the “DGCL”), Merger Sub will merge with and into PNAC (the “Merger”), with PNAC surviving the Merger as a wholly owned subsidiary of PubCo. The Merger will become effective at such time on the date of the closing of the Merger (the “Merger Closing”) as the certificate of merger is duly filed with the Secretary of State of the State of Delaware or at such other time specified in the certificates of merger (the “Merger Effective Time”). In addition, a wholly owned subsidiary of PubCo to be incorporated in Singapore (“New SubCo”) shall acquire the issued and outstanding shares of noco-noco from the Sellers; in exchange, PubCo shall issue to the shareholders of noco-noco the shares of PubCo (the “Share Exchange”, and together with the Merger and the other transactions contemplated by the Business Combination Agreement, the “Business Combination”), with noco-noco becoming a subsidiary of New SubCo. Upon the consummation of the Business Combination, PNAC will become a wholly-owned subsidiary of PubCo and noco-noco will be a subsidiary of PubCo with PubCo indirectly holding all or controlling equity interest in noco-noco, and the stockholders of PNAC and the Sellers would receive shares, par value \$0.0001 per share, of PubCo (“PubCo Ordinary Shares”) as consideration and become the shareholders of PubCo. Following the Merger Effective Time, PubCo will change its name to “noco-noco Inc.” PubCo and New SubCo joined as parties to the Business Combination Agreement on February 2, 2023 by executing and delivering signatures to the Business Combination Agreement pursuant to Sections 13.18 and 13.19 of the Business Combination Agreement.

We currently have until July 17, 2023 to consummate our Business Combination. However, if we anticipate that we may not be able to consummate our Business Combination by July 17, 2023, we may, but are not obligated to, extend the period of time to consummate a Business Combination for up to four times by an additional one-month period each time and may have until November 17, 2023 to consummate our Business Combination.

#### *Agreements with Advisors*

On October 25, 2022, we engaged Prime Number Capital LLC (“PNCPS”) and WestPark Capital, LLC (“WestPark”), the representatives of the underwriters for our IPO, to act as the financial advisors to us in connection with our initial business combination. Pursuant to their engagement letter, PNCPS and WestPark have agreed, if requested by and in consultation with us, among others, to assist us in the transaction structuring and negotiation of a definitive purchase agreement with respect to an initial business combination, hold meetings with our stockholders to discuss an initial business combination and the target’s attributes, introduce us to potential investors in connection with an initial business combination, assist us with relevant financial analysis, presentations, and press releases. PNCPS and Westpark will not receive any additional compensation for services rendered under this engagement except the deferred underwriting fee in the amount of \$2,257,500 as provided in a certain underwriting agreement dated May 12, 2022 among us, PNCPS and Westpark. We also agree to reimburse PNCPS and WestPark up to \$20,000 for their reasonable out-of-pocket expenses in connection with the performance of their services thereunder.

On October 25, 2022, we and PNCPS entered into a separate engagement letter whereby PNCPS would, among others, use its reasonable efforts in identifying and introducing potential targets, value potential initial business combination and assess the proposed structure for initial business combination and assist in managing the process and other related services. In exchange for its services, we have agreed to pay or cause the surviving entity to pay a service fee equal to 0.5% of the total value of all cash, securities, or other property paid or transferred at the closing by or to us, the target and/or their shareholders with respect to an initial business combination. On January 31, 2023, we and PNCPS amended the original engagement letter to set forth PNCPS’s compensation thereunder in connection with the Business Combination, which includes \$500,000 in cash and 609,756 newly issued PubCo Ordinary Shares, payable at the closing of the Business Combination. We also agree to reimburse PNCPS up to \$5,000 for its reasonable out-of-pocket expenses in rendering its services.

In addition, on April 30, 2023, PNAC entered into a Placement Agent Agreement with PNCPS, pursuant to which PNCPS shall act as the placement agent for the solicitation and placement of securities of PNAC, in exchange for a placement fee of 7% of the aggregate gross proceeds received by PNAC from the sales of such securities.

#### *Notice of Delisting*

On April 20, 2023, the “Company received a letter (the “Letter”) from the Listing Qualifications division (the “Staff”) of the Nasdaq Stock Market LLC (“Nasdaq”) stating that the Company has not paid certain fees required by Nasdaq Listing Rule 5250(f) and that the Company will be delisted unless it appeals such determination. As of the date of the Letter, the Company’s past due fee balance totaled \$70,000. If the Company elects not to appeal, trading of its common stock will be suspended at the opening of business on May 1, 2023, and a Form 25-NSE will be filed with the Securities and Exchange Commission, which will remove the Company’s securities from listing and registration on Nasdaq.

The Company made the payment of annual listing fee of \$70,000 in full on April 24, 2023. On April 25, 2023, the Staff notified the Company via a second letter that the matter is closed. The Company expects its common stock will continue to be listed and trading on Nasdaq.

#### *Issuance of Working Capital Note*

On April 23, 2023, DBG Global Limited, a member of Sponsor A, agreed to loan the Company up to \$24,000 to be used for a portion of the working capital. This loan is non-interest bearing, unsecured and is due at the earlier of (1) the date on which the Company consummates its initial business combination or (2) the date on which the Company liquidates. As of March 31, 2023, a total of \$24,000 was drawn by the Company and no balance has been repaid as of the date of this proxy statement/prospectus.

#### *Special Stockholder Meeting and First Extension*

Under our then effective amended and restated certificate of incorporation (the “Charter”), we would have until May 17, 2023 to complete an initial business combination, which may be extended up to two times by an additional three-month period each time until November 17, 2023. On May 15, 2023, we held a special meeting of stockholders (the “Special Meeting”). At the Special Meeting, the stockholders of the Company approved the proposal to amend our Charter to (i) allow the Company until May 17, 2023 to consummate an initial business combination, and to (ii) elect to extend the period to consummate an initial business combination up to six times, each by an additional one-month period, for a total of up to six months to November 17, 2023 (“Extended Termination Date”), by depositing to the Company’s Trust Account the amount lesser of (i) \$125,000 for each one-month extension or (ii) \$0.045 for each Public Share for each one-month extension (the “Extension Amendment Proposal”). Upon the stockholders’ approval, on May 17, 2023, we filed a certificate of amendment to the Charter which became effective upon filing on the same date, pursuant to which, we may elect to extend the period to consummate an initial business combination up to six times, each by an additional one-month period (each, a “Monthly Extension”), for a total of up to six months to November 17, 2023, by depositing to the Trust Account \$125,000 for each one-month extension.

In connection with the votes to approve the Extension Amendment Proposal, 1,537,701 Public Shares of the Company were tendered for redemption. As of the date of this proxy statement/prospectus, all such Public Shares are in the process of redemption by our transfer agent, VStock Transfer, LLC, which shall result in a total of 4,912,299 Public Shares, or 6,923,691 Class A Common Stock remaining after the consummation of such process.

On May 17, 2023, an aggregate of \$125,000 was deposited into the Trust Account for the public stockholders, resulting in an extension of the period of time we have to consummate the initial business combination by one month from May 17, 2023 to June 17, 2023 (the “First Monthly Extension”).

#### *Noco-noco Note*

On May 17, 2023, we issued an unsecured promissory note of \$208,594.15 (the “noco-noco Note”) to noco-noco to evidence the payments made by noco-noco for the deposit for First Monthly Extension and 50% of the registration fee for filing of a registration statement/proxy statement in Form F-4 with the U.S. securities and exchange commission. The noco-noco Note bears no interest and is payable in full upon the earlier to occur of (i) the consummation of an initial business combination or (ii) the date of expiry of the term of the Company, in cash or shares of the Company at \$10.00 per share, at the discretion of the note holder.

### *Second Extension*

On June 14, 2023, an additional aggregate of \$125,000 was deposited by noco-noco upon request by the sponsors of the Company, into the Trust Account of the Company, as a result of which, the Company has extended the period of time it has to consummate its initial business combination by one month from June 17, 2023 to July 17, 2023. This is the second of the six Monthly Extension permitted under the Existing PNAC Charter.

In connection with the Monthly Extension Payment, the Company issued an unsecured promissory note of \$125,000 (the “June noco-noco Note”) to noco-noco. The June noco-noco Note is non-interest bearing and payable (subject to the waiver against trust provisions) on the earlier of (i) consummation of the Company’s initial business combination and (ii) the date of the liquidation of the Company. The principal balance may be prepaid at any time, at the election of the Company. The holder of the June noco-noco Note has the right, but not the obligation, to convert the Note, in whole or in part, respectively, into private placement shares (the “Working Capital Shares”) of the Company, by providing the Company with written notice of its intention to convert the Note at least two business days prior to the closing of the Company’s initial business combination. The number of Working Capital Shares to be received by the holder in connection with such conversion shall be an amount determined by dividing (x) the sum of the outstanding principal amount payable to the holder, by (y) \$10.00.

### **Results of Operations**

We have neither engaged in any operations nor generated any operating revenues to date except the preparation and completion of the IPO and search for target candidate following the consummation of the IPO. Our only activities from inception through March 31, 2023 were organizational activities and those necessary to prepare for the IPO, described below. We do not expect to generate any operating revenue until after the completion of our initial business combination. We expect to generate non-operating income in the form of interest income on marketable securities held after the IPO. We expect that we will incur increased expenses as a result of being a public company (for legal, financial reporting, accounting and auditing compliance), as well as for due diligence expenses in connection with searching for, and completing, an initial business combination.

For the three months ended March 31, 2023, we had a net income of \$230,529, which consisted of general and administrative expenses of \$324,659, franchise tax of \$16,600, income tax of \$140,023, and deferred income tax of \$1,429, offset by unrealized gain on investments held in the Trust Account of \$42,081, and interest earned on the investments held in the Trust Account of \$671,159. For the three months ended March 31, 2022, we had a net loss of \$9,952, all of which consisted of formation and operating costs.

For the year ended December 31, 2022, we had a net income of \$141,931, which consisted of general and administrative expenses of \$588,973, franchise tax of \$47,980, income tax of \$112,446 and deferred income taxes provision of \$37,190, offset by unrealized gain on investments held in Trust Account of \$215,965, and interest earned on the investments held in the Trust Account of \$712,555. For the period from February 25, 2021 (inception) through December 31, 2021, we had a net loss of \$1,357, all of which consisted of formation and operating costs.

### **Liquidity and Going Concern**

On May 17, 2022, we consummated the IPO of 6,450,000 Public Units at a price of \$10.00 per unit, generating gross proceeds of \$64,500,000. Simultaneously with the closing of the IPO, we consummated the Private Placement of 398,892 shares (including 349,032 shares to sponsor A, and 49,860 shares to sponsor B) at a price of \$10.00 per share generating gross proceeds of \$3,988,920. Following the closings of the IPO and the Private Placement on May 17, 2022, a total of \$65,790,000 (or \$10.20 per share) was placed in the Trust Account.

As of March 31, 2023, the Company had cash of \$99,790 and a working capital deficit of \$54,837 (excluding investments held in trust account, deferred underwriting fee payable, deferred income tax liability and taxes payable). The Company’s liquidity needs up to the closing of the IPO on May 17, 2022 had been satisfied through proceeds from notes payable and advances from related party and from the issuance of common stock.

As of March 31, 2023, we had marketable securities held in the Trust Account of \$67,431,759 consisting of securities held in money market funds that invests in United States government treasury bills, bonds or notes with a maturity of 185 days or less. Interest income on the balance in the Trust Account may be used by us to pay taxes. Through March 31, 2023, we did not withdraw any interest earned on the Trust Account to pay our taxes. We intend to use substantially all of the funds held in the Trust Account, to acquire a target business and to pay our expenses relating thereto. To the extent that our capital stock is used in whole or in part as consideration to effect an initial business combination, the remaining funds held in the Trust Account will be used as working capital to finance the operations of the target business. Such working capital funds could be used in a variety of ways including continuing or expanding the target business’ operations, for strategic acquisitions and for marketing, research and development of existing or new products. Such funds could also be used to repay any operating expenses or finders’ fees which we had incurred prior to the completion of our initial business combination if the funds available to us outside of the Trust Account were insufficient to cover such expenses.

We have until July 17, 2023 to consummate an initial business combination (or until November 17, 2023, if extended). It is uncertain that we will be able to consummate a Business Combination by this time. If an initial business combination is not consummated by this date or, if extended, by the Extended Termination Date, there will be a mandatory liquidation and subsequent dissolution.

In order to finance transaction costs in connection with an initial business combination, the Company's Sponsors or an affiliate of the Sponsors or certain of the Company's officers and directors may, but are not obligated to, provide the Company with working capital. The Company's management plans to continue its efforts to complete an initial business combination within the Combination Period after the closing of the IPO.

If the estimated costs of identifying a target business, undertaking in-depth due diligence and negotiating an initial business combination are less than the actual amount necessary to do so, the Company may have insufficient funds available to operate its business prior to its initial business combination. Moreover, the Company may need to obtain additional financing either to complete its initial business combination or because it becomes obligated to redeem a significant number of public shares upon consummation of its initial business combination, in which case the Company may issue additional securities or incur debt in connection with such initial business combination. Subject to compliance with applicable securities laws, the Company would only complete such financing simultaneously with the completion of our initial business combination.

In connection with the Company's assessment of going concern considerations in accordance with FASB ASC Topic 205-40, "Presentation of Financial Statements — Going Concern," management has determined that mandatory liquidation, should an initial business combination not occur, and potential subsequent dissolution raises substantial doubt about the Company's ability to continue as a going concern for a reasonable period of time, which is considered to be one year from the issuance of the financial statements.

### **Off-Balance Sheet Financing Arrangements**

We have no obligations, assets or liabilities that would be considered off-balance sheet arrangements as of March 31, 2023. We do not participate in transactions that create relationships with unconsolidated entities or financial partnerships, often referred to as variable interest entities, which would have been established for the purpose of facilitating off-balance sheet arrangements. We have not entered into any off-balance sheet financing arrangements, established any special purpose entities, guaranteed any debt or commitments of other entities, or purchased any non-financial assets.

### **Contractual Obligations**

As of March 31, 2023, we do not have any long-term debt, capital lease obligations, operating lease obligations or long-term liabilities.

On October 25, 2022, we engaged PNCPS and WestPark, the representatives of the underwriters for our IPO, to act as the financial advisors to us in connection with its initial business combination. Pursuant to their engagement letter, PNCPS and WestPark have agreed, if requested by and in consultation with us, among others, to assist us in the transaction structuring and negotiation of a definitive purchase agreement with respect to a business combination, hold meetings with us stockholders to discuss business combination and the target's attributes, introduce us to potential investors in connection with a business combination, assist us with relevant financial analysis, presentations, press releases. PNCPS and Westpark will not receive any additional compensation for services rendered under this engagement except the deferred underwriting fee in the amount of \$2,257,500 as provided in a certain underwriting agreement dated May 12, 2022 among us, PNCPS and Westpark. We also agree to reimburse PNCPS and WestPark up to \$20,000 for its reasonable out-of-pocket expenses in connection with the performance of their services thereunder.

On October 25, 2022, we and PNCPS entered into a separate engagement whereby PNCPS would, among others, use its reasonable efforts in identifying and introducing potential targets, evaluate potential business combination and assess the proposed structure for business combination and assist in managing the process and other related services. In exchange for its services, we have agreed to pay or cause the surviving entity to pay a service fee equal to 0.5% of the total value of all cash, securities, or other property paid or transferred at the closing by or to us, the target and/or their shareholders with respect to a business combination. On January 31, 2023, we and PNCPS amended the original engagement to set forth PNCPS's compensation thereunder in connection with the Business Combination, which includes \$500,000 in cash and 609,756 newly issued PubCo Ordinary Shares, payable at the Closing. We also agree to reimburse PNCPS up to \$5,000 for its reasonable out-of-pocket expenses in rendering their services.

In addition, on April 30, 2023, PNAC entered into a Placement Agent Agreement with PNCPS, pursuant to which PNCPS shall act as the placement agent for the solicitation and placement of securities of PNAC, in exchange for a placement fee of 7% of the aggregate gross proceeds received by PNAC from the sales of such securities.

Pursuant to these arrangements, we are obligated to pay the Representatives the deferred underwriting compensation equal to 3.5% of the IPO Proceeds. The deferred underwriting compensation will become payable to the Representatives from the amounts held in the Trust Account solely in the event that we complete an initial business combination. In addition, in connection with and upon the closing of the Business Combination, we will pay or cause the surviving entity of the Business Combination to pay PNCPS \$500,000 in cash and issue 609,756 in new PubCo Ordinary Shares.

The holders of the founder shares, the Private Placement Shares, and any common stock that may be issued upon conversion of working capital loans (and any underlying securities) will be entitled to registration rights pursuant to a registration and shareholder rights agreement entered into in connection with the IPO. The holders of these securities are entitled to make up to three demands, excluding short form demands, that we register such securities. In addition, the holders have certain "piggy-back" registration rights with respect to registration statements filed subsequent to our completion of our initial business combination. We will bear the expenses incurred in connection with the filing of any such registration statements.

## **Critical Accounting Policies**

### ***Basis of Presentation***

The accompanying unaudited condensed financial statements are presented in conformity with accounting principles generally accepted in the United States of America (“US GAAP”) and pursuant to the rules and regulations of the SEC. The interim financial information provided is unaudited, but includes all adjustments which management considers necessary for the fair presentation of the results for these periods. Actual results could materially differ from those estimates. We have identified the following critical accounting policies:

### ***Offering Costs***

The Company complies with the requirements of FASB ASC Topic 340-10-S99-1, “Other Assets and Deferred Costs – SEC Materials” (“ASC 340-10-S99”) and SEC Staff Accounting Bulletin Topic 5A, “Expenses of Offering”. Offering costs consisting principally of underwriting, legal, accounting and other expenses that are directly related to the IPO and charged to shareholders’ equity upon the completion of the IPO.

### ***Warrants***

We account for warrants as either equity-classified or liability-classified instruments based on an assessment of the warrant’s specific terms and applicable authoritative guidance in ASC 480 “Distinguishing Liabilities from Equity” (“ASC 480”) and ASC 815, Derivatives and Hedging (“ASC 815”). The assessment considers whether the warrants are freestanding financial instruments pursuant to ASC 480, whether they meet the definition of a liability pursuant to ASC 480, and whether the warrants meet all of the requirements for equity classification under ASC 815, including whether the warrants are indexed to the Company’s own common stock and whether the warrant holders could potentially require “net cash settlement” in a circumstance outside of the Company’s control, among other conditions for equity classification. This assessment, which requires the use of professional judgment, is conducted at the time of warrant issuance and as of each subsequent quarterly period end date while the warrants are outstanding.

For issued or modified warrants that meet all of the criteria for equity classification, the warrants are required to be recorded as a component of equity at the time of issuance. For issued or modified warrants that do not meet all the criteria for equity classification, the warrants are required to be recorded as liabilities at their initial fair value on the date of issuance, and each balance sheet date thereafter. Changes in the estimated fair value of the warrants are recognized as a non-cash gain or loss on the statements of operations. We determined that upon further review of the proposed form of warrant agreement, management concluded that the warrants included in the units issued in the IPO pursuant to the warrant agreement qualify for equity accounting treatment.

### ***Common Stock Subject to Possible Redemption***

The Company accounts for its common stock subject to possible redemption in accordance with the guidance in ASC Topic 480 “Distinguishing Liabilities from Equity.” Common stock subject to mandatory redemption (if any) are classified as a liability instrument and are measured at fair value. Conditionally redeemable common stock (including common stock that feature redemption rights that are either within the control of the holder or subject to redemption upon the occurrence of uncertain events not solely within the Company’s control) are classified as temporary equity. At all other times, common stock is classified as stockholders’ equity. The PNAC Public Shares feature certain redemption rights that are considered to be outside of the Company’s control and subject to occurrence of uncertain future events. Accordingly, as of December 31, 2022, shares of Class A Common Stock subject to possible redemption are presented at redemption value of \$10.34 per share as temporary equity, outside of the stockholders’ equity section of our balance sheet. The Company recognizes changes in redemption value immediately as they occur and adjusts the carrying value of redeemable common stock to equal the redemption value at the end of each reporting period. Increases or decreases in the carrying amount of redeemable common stock are affected by charges against additional paid in capital or accumulated deficit if additional paid in capital equals to zero.

### ***Net Income (Loss) per Share***

The Company complies with accounting and disclosure requirements of ASC 260, Earnings Per Share. In order to determine the net income (loss) attributable to both the redeemable shares and non-redeemable shares, the Company first considered the undistributed income (loss) allocable to both the redeemable common stock and non-redeemable common stock and the undistributed income (loss) is calculated using the total net loss less any dividends paid. The Company then allocated the undistributed income (loss) ratably based on the weighted average number of shares outstanding between the redeemable and non-redeemable common stock. Any remeasurement of the accretion to redemption value of the common stock subject to possible redemption was considered to be dividends paid to the public stockholders.



### ***Recent Accounting Pronouncements***

In August 2020, FASB issued Accounting Standards Update (“ASU”) 2020-06, Debt — Debt with Conversion and Other Options (Subtopic 470-20) and Derivatives and Hedging — Contracts in Entity’s Own Equity (Subtopic 815-40) (“ASU 2020-06”) to simplify accounting for certain financial instruments. ASU 2020-06 eliminates the current models that require separation of beneficial conversion and cash conversion features from convertible instruments and simplifies the derivative scope exception guidance pertaining to equity classification of contracts in an entity’s own equity. The new standard also introduces additional disclosures for convertible debt and freestanding instruments that are indexed to and settled in an entity’s own equity. ASU 2020-06 amends the diluted earnings per share guidance, including the requirement to use the if-converted method for all convertible instruments. ASU 2020-06 is effective January 1, 2024 for the Company and should be applied on a full or modified retrospective basis, with early adoption permitted beginning on January 1, 2021. The Company is currently assessing the impact, if any, that ASU 2020-06 would have on its financial position, results of operations or cash flows.

Management does not believe that any other recently issued, but not yet effective, accounting pronouncements, if currently adopted, would have a material effect on the Company’s financial statement.

## INDUSTRY OVERVIEW RELATING TO NOCO-NOCO'S BUSINESS

The information presented in this section and included elsewhere in this proxy statement/prospectus that relates to the industry of noco-noco's business has been derived from research reports conducted by Frost & Sullivan. Investors are cautioned not to place any undue reliance on the information, including statistics and estimates, set forth in this section or similar information included elsewhere in this proxy statement/prospectus.

### Global Carbon-Free Leasing Market

#### Overview of Lithium-ion Battery

Lithium-ion battery is a type of a rechargeable battery achieving its charging and discharging process through the move back and forth of lithium-ion in electrolyte between the cathode and anode. Based on applications, lithium-ion batteries mainly include EV battery and ESS battery. In 2021, the total demand for EV battery accounted for the largest segment among types of lithium-ion batteries, with the global installed capacity of EV battery being 293.7GWh. With increasing consumer acceptance of EVs and additional regulatory support for EV sales, the global EV battery installed capacity is expected to reach 1,898.1GWh by 2026, with a projected CAGR of 39.6% between 2022 and 2026. On the other hand, the newly installed capacity of global ESS battery was 53.5GWh in 2021. Similar to EV battery, the demand for ESS battery is also expected to increase exponentially in the coming years. The newly installed capacity of ESS battery is expected to reach 682.6GWh in 2026, with an estimated CAGR of 58.5% between 2022 and 2026.

The main components of a lithium-ion battery include cathode, anode, separator, and other materials. The separator, as an essential component of lithium-ion batteries, prevents electrical short-circuits and provides a pathway for lithium ions to move between the cathode and anode. Advanced separators can provide lithium-ion batteries with competitive advantages such as higher energy density as compared to LFP (lithium iron phosphate) batteries, and longer battery lifespan. With higher energy density, LMFP (lithium manganese iron phosphate) batteries allow car manufacturers to install smaller volume/weight batteries per vehicle to meet the range requirements. Meanwhile, with longer battery lifespan, LMFP batteries can be reused for secondary purposes. For example, EV batteries can be redeployed and installed in ESS systems, which have lower requirements on battery capacities and performances. Both factors contribute to the reduction of global carbon emission.

#### Overview of Carbon-free Leasing Programs

Carbon-free leasing is a type of leasing program in which the lessee, the person or organization, rent instead of purchase lithium-ion battery to reduce the carbon emission. Carbon-free leasing mainly consists of carbon-free EV leasing, carbon-free EV battery leasing and carbon-free ESS battery leasing programs.

*Carbon-free EV leasing program:* Carbon-free EV leasing programs are a smart and efficient way for commercial fleet management companies and individual customers to stay ahead of the curve and support their bottom line while contributing to a greener future. With the integration of IoT (internet of things) technology, customers will have access to real-time data and insights about their vehicle's performance, usage patterns, and charging status. This information can be used to optimize the driving experience, reduce operational costs, and enhance overall vehicle efficiency. In addition, companies and individuals can save on upfront costs and maintenance expenses, as well as benefit from tax incentives and reduced fuel costs by leasing EVs. Furthermore, the use of EVs can help enhance corporate image and promote sustainability of business operations, leading to increasing brand loyalty and customer satisfaction.

*Carbon-free EV battery leasing program:* There are numerous benefits to the carbon-free EV battery leasing program. The program allows companies or individuals to purchase EVs without having to make large upfront investments in the battery. It also allows the lessor to manage the battery and provide regular maintenance, which can increase the overall lifespan of the battery. Similar to IoT-embedded EVs, with the installation of IoT-enabled battery management systems, lessees such as fleet management companies and individual customers are able to visualize and control battery performance and usage, ultimately provide better user experiences. Meanwhile, the program benefits the society by making the EV more accessible for many people by reducing the total cost of ownership, ultimately increase EV ownerships and reduce carbon emissions.

*Carbon-free ESS battery leasing program:* Carbon-free ESS battery leasing program is a program in which the lessee pays for the rental fee of lithium-ion batteries installed in the energy storage system. The carbon-free ESS battery leasing program helps to extend the life of these batteries and reduces the amount of electronic waste generated, providing a sustainable solution for the disposal of used batteries. The program also helps to reduce carbon emissions in the production of additional ESS batteries and provides a clean energy storage solution for the grid. Overall, the Carbon-free ESS battery leasing program provides numerous benefits for both customers and society, making it a smart and sustainable solution for energy storage.

### **Industry Value Chain Analysis**

The carbon-free leasing industry is composed of several key participants, including battery manufacturers, system integrators, battery charging and swapping solution providers, battery leasing and recycling companies, EV manufacturers, fleet management companies, as well as ESS producers and operators. Battery manufacturers produce the batteries using raw materials such as lithium, cobalt, and nickel. While, ESS integrators create complete ESS for use in EVs and renewable energy stations.

Customers in the carbon-free leasing industry, which may include EV manufacturers, fleet management companies, battery charging and swapping solution providers, and renewable energy station operators, rely on carbon-free leasing companies to provide them with batteries or EVs, allowing them to avoid the expenses on R&D and allow them to focus on their core operations.

Carbon-free leasing and recycling companies act as intermediaries and initiators between EV manufacturers, ESS integrators, and customers by offering a comprehensive solution. On the leasing side, carbon-free leasing and recycling companies cater to various customer needs, including the leasing of EVs, EV batteries, and ESS batteries as well as the maintenance and monitoring of the batteries, vehicles, and ESSs using IoT technology. The ability to provide various services allow carbon-free leasing and recycling companies to better serve its customers by optimize the customer experience, reduce operational costs, and improve overall efficiency. On the recycling side, the companies are accountable for ensuring appropriate recycling of the batteries at the end of their life cycle, which contributes to a dependable and sustainable supply of EVs, ESSs, and batteries, thus reduces the environmental impact by lowering the demand for raw materials.

### **Market Size of Global Carbon-free Leasing Industry**

The EV battery can be classified into two categories based on the number of wheels where it is installed: electric two-wheeler (E2W) battery and electric four-wheeler (E4W) battery. Due to disruptions in worldwide supply chains, the cost of lithium-ion batteries has increased, causing a slight decline in the global E2W market size by sales volume in 2022. However, as the global supply chain stabilizes, the market size is expected to grow from 21.7 million units in 2021 to 52.9 million units in 2026, with a CAGR of 19.6%.

With the rising cost of research and development expenses for battery technology due to intense competition, more E2W manufacturers will opt to source their in-vehicle lithium-ion batteries from external battery leasing companies. By sourcing from battery leasing companies, E2W manufacturers not only save cost but also provides the companies with time-to-market advantage, reduced capital investment risks, improved production efficiency, and provides greater access to top-tier talents. As a result, the growth in the global E2W industry will drive the growth of the carbon-free leasing industry.

### Market Size of Global E2W Industry by Sales Volume, 2021-2026E

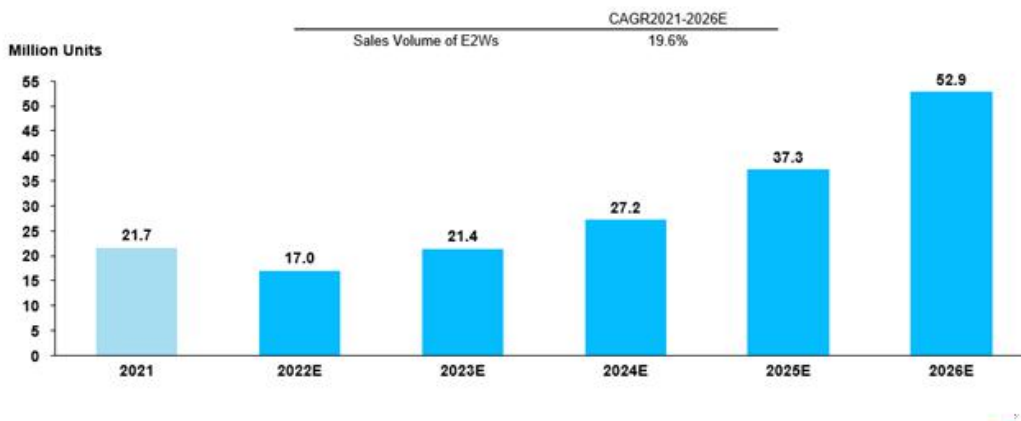

Source: Frost & Sullivan

Note: The E2W vehicle in the chart refer to lithium-ion battery E2Ws.

Despite supply chain disruptions, the global E4W industry has seen substantial growth in recent years due to advancements in lithium-ion technologies, which enable E4Ws to travel greater distances and perform well in harsh weather conditions. The sales volume of E4Ws is projected to grow from 6.7 million units in 2021 to 32.5 million units in 2026, with a CAGR of 37.1%. The primary driver of industry growth is commercial E4Ws, with more and more fleet management companies opting for E4W leasing programs to reduce initial investment and improve return on capital. The sales volume of commercial E4Ws is expected to rise from 0.4 million units in 2021 to 3.4 million units in 2026, with a CAGR of 54.0%. As customers recognize the benefits of carbon-free leasing programs, including reduced vehicle costs and a more environmentally friendly option for recycling batteries at the end of use, the global carbon-free leasing industry is also poised to grow exponentially in the coming years.

### Market Size of Global E4W Industry by Sales Volume, 2021-2026E

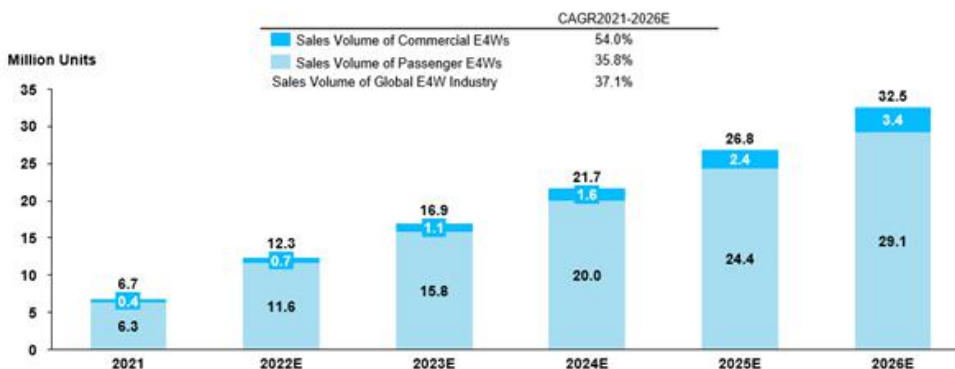

Source: Frost & Sullivan

Note: The commercial E4Ws in the chart refer to electric trucks, buses, and vans, while passenger E4Ws refer to electric cars.

The ESS battery can be divided into two categories based on where the energy is stored and its intended consumer: the energy generation and transmission side, and the energy user side. In 2021, the market size for the ESS battery industry in the energy generation and transmission side, as measured by newly installed capacity, reached 16.4GWh. Currently, energy generation side account for over 80% of the total market share, with 13.8GWh newly installed in 2021. With increasing demand for energy consumption, the market size for the ESS battery industry by newly installed capacity in the energy generation and transmission side is expected to experience significant growth and reach 271.2GWh by 2026, with a CAGR of 75.4% from 2021. The newly installed capacity of energy generation side is forecasted to reach 247.4GWh, with a CAGR of 78.2% from 2021, and make up 91.2% of the total market share.

**Market Size of Global ESS Battery Industry by Newly Installed Capacity on Energy Generation and Transmission Side, 2021-2026E**

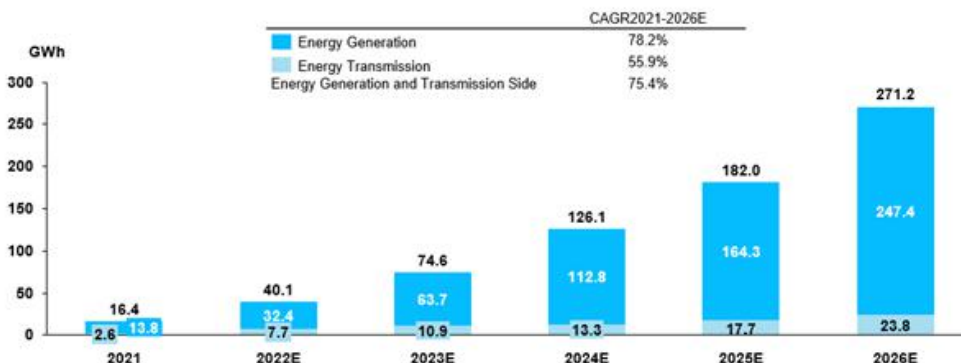

Source: Frost & Sullivan

Meanwhile, ESS battery industry on the user side can be divided into residential and commercial & industrial (C&I) segments. In 2021, the market size for ESS battery on the energy user side, measured by newly installed capacity, reached 7.7GWh, with the residential segment accounting for 56.1% and the C&I segment accounting for 43.9% of the energy generation and transmission side market share. Due to the expansion of distributed renewable energy and the increasing environmental awareness among residential and commercial users, the market size for ESS battery on the energy user side is expected to grow significantly and reach 239.2GWh of newly installed capacity by 2026, with a CAGR of 98.6% between 2021 and 2026. By 2026, the newly installed capacity of the residential and C&I segments is expected to reach 125.3GWh and 113.9GWh, respectively. At present, the carbon-free ESS battery leasing industry is still in its early stages. However, with cost reductions provided by the cascade usage of EV batteries, the growth in the ESS battery industry will contribute to the growth in the carbon-free ESS battery leasing industry as battery leasing is not only a cheaper alternative but also a more environmentally friendly one.

## Market Size of Global ESS Battery Industry by Newly Installed Capacity on Energy User Side, 2021-2026E

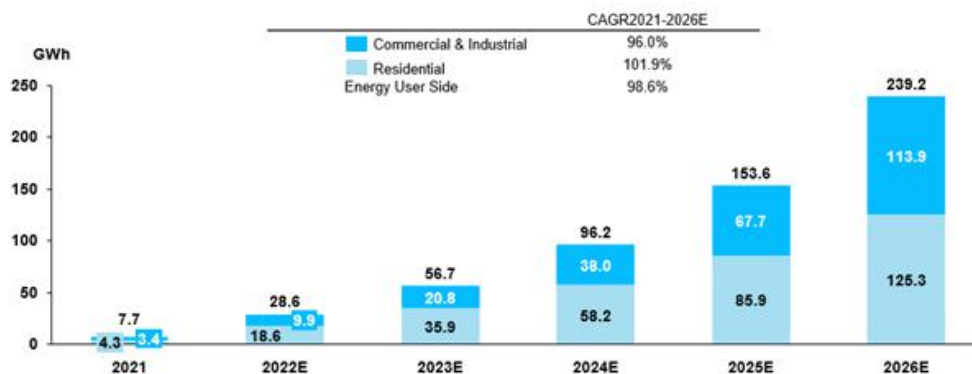

Source: Frost & Sullivan

### Market Drivers and Trends of Global Carbon-free Leasing Industry

#### Increasing Demand for Carbon-free Leasing

As the world shifts towards cleaner sources of energy, carbon-free leasing companies are seeing an increase in demand for their services.

Growing public awareness of climate change initiatives is driving the demand for EVs and the adoption of carbon-free EV as well as EV battery leasing programs. The trend of carbon-free EV and EV battery leasing is expected to grow rapidly in the world as it provides a solution to the cost of acquisition along with the concerns related to battery-life that still affect the large-scale uptake of EVs. The carbon-free EV and EV battery leasing model can reduce vehicle upfront cost and divide the cost of owning and maintaining an EV over its lifetime. In addition, carbon-free EV and EV battery leasing offers additional benefits such as timely inspection of vehicle and battery residual values, replacements, and assistance by the service provider, which can efficiently improve the user experience and vehicle utilization. Furthermore, carbon-free EV and EV battery leasing services are bolstered by rising logistics activities. For example, shared mobility, logistics, and delivery companies with large fleets will gain significant cost benefits with the leasing model covering repair, service, and replacement of EVs and EV batteries.

In terms of the ESS segment, carbon-free leasing is also a new business model that will see increasing demand from both power generation and transmission companies as well as C&I users of ESS. Energy storage batteries are an indispensable part of the ESS. With the growing trend of harnessing renewable energy sources, lithium-ion batteries have emerged as the ideal energy storage units adopted globally. Carbon-free leasing can improve the flexibility and efficiency of ESS deployment as well as reduce the upfront cost and overall risks of energy storage projects, thus accelerating the shift towards zero-emission targets. Looking forward, driven by the further penetration of ESS and promotion of cascade use of lithium-ion batteries, the market of carbon-free leasing services is anticipated to grow rapidly in the world.

#### Battery Recycling Brings Additional Source of Revenue to Carbon-free Leasing Companies

Carbon-free battery leasing companies are looking to recycle used batteries to prolong the lifespan of lithium-ion batteries, reduce the environmental impact of battery production and disposal, while also providing a new source of revenue. Through cascade use and battery recycling, the utilization rate of lithium-ion batteries can be significantly increased. When the lithium-ion batteries cannot meet the power demand of EVs after extensive usage, the removed lithium-ion batteries can be reused in ESS. The battery cost is the main component of the initial cost of an ESS. Therefore, reducing the costs of energy storage batteries will be the key to promote the application of ESS, and the cascade use of EV batteries is expected to be an important approach. Looking forward, ESS users will gradually take the used EV batteries as an important source of energy storage batteries.

Meanwhile, the continuous upgrades and innovations of lithium-ion battery technologies will further stimulate the cascade use and recycling of lithium-ion batteries. Some leading carbon-free battery leasing companies master the advanced battery technologies and can provide carbon-free batteries with longer lifespan, higher energy density and better heat resistance. Such superior battery performance enables cascade use and battery recycling as it maximizes the battery utilization, which will bring additional source of revenue and broaden the application scenarios of carbon-free batteries.

### ***Entry Barriers of Global Carbon-free Leasing Industry***

#### ***Capital Investment Barrier***

Companies in the carbon-free leasing industry require significant long-term capital investment, and the importance of capital runs through every stage of R&D, production and expansion of the company. Companies with a first-mover advantage in the carbon-free leasing market are able to upgrade their manufacturing technology and produce or purchase the batteries through rapid market changes. New entrants who do not have sufficient capital reserves to respond to market changes and keep up with changing market trends will find it difficult to maintain their competitiveness in the competitive market.

#### ***Technological Barrier***

The carbon-free leasing industry is a technology-intensive industry, and a comprehensive system of technical capabilities and research results is the basis for companies to gain a foothold in the industry. Companies placed in the leading position in the industry continue to consolidate their technological advantage by making breakthroughs at key technological levels through cooperation with research institutes. New entrants to the market often lack technical accumulation, thus will be subject to rapidly changing technology and innovation.

### **Global Carbon Credit Trading Market**

#### ***Overview of Carbon Credit Trading***

Carbon credit trading is the buying and selling of the right referring as the carbon credit for a company or entity to emit a certain amount of carbon dioxide which is hard to eliminate. If a company goes beyond the defined limits of carbon emission regulated by the governments, it has to purchase credits to meet the emission requirements. The carbon credits are mainly generated from environmental protection projects that identify carbon credit generating from crops and trees and implement best management practices to generate credits. For instance, planting trees for forestry is currently the main carbon sink used in Australia. Environmental protection projects involving planting trees to establish new and permanent forest cover can earn carbon credits for carbon dioxide equivalent stored in the project trees as they grow, which can be traded in the carbon marketplaces.

According to the purpose of the transaction, the carbon credit trading market can be classified in compliance and voluntary carbon credit trading markets. Compliance carbon credit trading market is created as a result of national or regional regulatory requirement. Voluntary carbon credit trading markets refer to the issuance, buying and selling of carbon credits on a voluntary basis.

#### ***Industry Value Chain Analysis***

The upstream of the carbon credit trading market mainly comprises carbon credit providers such as environmental protection project developers, carbon credit contract landowners and governments who set up the projects developing and issuing carbon credits. The midstream of the carbon credit trading market are carbon credit transactors including brokers and traders who purchase large amounts of credits directly from the suppliers, bundle those credits into portfolios and sell to the end buyers with a certain commission. The downstream of the carbon credit trading market are primarily the greenhouse emitters including electricity, gas and other utility companies who need carbon credits to meet regulatory emission requirements.

### Market Size of Global Carbon Credit Trading Industry

The carbon credit trading is a cost-effective solution to mitigate or reduce climate change and global warming, which also creates financial incentives for countries and companies to develop emission-reducing technologies to help reduce carbon levels in the atmosphere. Driven by the strict carbon emission regulation and policies issued by the governments in the world to realize the goal of carbon neutrality, the demand of carbon credit has increased significantly. It is expected that the market size of carbon credit trading industry by transaction amount will surge from \$851.0 billion in 2021 to \$6,730.1 billion in 2026 at a CAGR of 51.2%.

**Market Size of Global Carbon Credit Trading Industry by Transaction Amount, 2021-2026E**



Source: Frost & Sullivan

### Market Drivers and Trends of Global Carbon Credit Trading Industry

#### Government Regulation Boosting Globalization of Carbon Credit Trading

Regarding to the stricter government regulations on carbon market, more countries are suffering from surging carbon credit unit prices due to the local limitation of decarbonization measures, renewable energy deployment, land availability and other related regional restrictions. For example, Australia has applied the ACCUs to meet with the goal of reducing Australia’s net greenhouse gas emissions to zero by 2050 in the “Climate Change Bill 2022.” As one ACCU represents one ton of carbon dioxide equivalent greenhouse gas that is not released into the atmosphere, individual and corporations have high demand on ACCUs to offset remaining carbon emissions, thus soaring the ACCU prices to a new record by increasing over 200% in 2021. Owing to the “Article 6 of the Paris Agreement” which allows countries to voluntarily cooperate with each other to achieve emission reduction targets set out in their Nationally Determined Contributions (NDCs), those countries are able to purchase carbon credits from other countries to offset the remaining carbon emissions of their own in order to achieve the national climate target, thus activating the carbon credit trading globalization. As a market surging in demand, Australia has launched the “Indo-Pacific Carbon Offsets Scheme” to help neighbor countries like Pacific island countries Fiji and Papua New Guinea generate credits for a fast-growing Australian carbon market. Another country engaging in the globalization of carbon credit trading in APAC area is Singapore. The Singapore government is actively promoting bilateral carbon market cooperation agreements with other countries to build a bilateral government framework for the cross-border transfer of carbon emissions. So far, Singapore has signed carbon market cooperation memoranda with Vietnam, Colombia, Morocco, Peru, Papua New Guinea and other countries. Therefore, with the implementation of relevant government regulations into actual carbon credit trading operation, it will help to promote more countries to establish carbon credit trading markets with countries like Australia and Singapore, boosting the associated market development.



### *Increasing Demand for Carbon Offsetting*

Carbon credit market participants can generally be divided into two groups: compliance participants, who are governed by carbon emission policies, and voluntary participants, including private companies, individuals, governments, and NGOs who choose to offset their carbon emissions. Government policies and regulations play an important role in the implementation of carbon offsets, while voluntary participation reflects a growing social consciousness. The number of voluntary carbon participants has greatly increased due to the increasing focus on environmental, social, and governance (ESG) investments. More businesses are establishing their own carbon reduction initiatives for more sustainable and environmentally friendly operations. However, these firms may struggle to find ways to offset their carbon emissions and achieve their ESG goals. Meanwhile, carbon abatement solution providers serve as a bridge between these companies and transferable carbon credit CO<sub>2</sub> sequestrators, offering carbon emitting companies with a temporary legal alternative while increase revenue for CO<sub>2</sub> sequestrators. As a result, carbon credit trading industry has thrived in recent years with growing demand for carbon offsetting.

### ***Entry Barriers of Global Carbon Credit Trading Industry***

#### *Capital Investment Barrier*

As an important medium for carbon trading markets to operate in accordance with standards and systems, high initial investment is an important pillar for carbon trading companies requiring long-term sustainability. Carbon credit trading companies with sufficient capital strength to generate carbon credits through a significant initial capital investment to build the necessary infrastructure and comply with regulations. However, new entrants with insufficient capital will face considerable resistance when entering the market, thus forming the high initial investment barrier.

#### *Market Volatility Barrier*

The price of carbon credits is a significant market indicator, which can be highly volatile and difficult to predict, thus make it challenging for companies to plan and budget for their participation in the carbon trading market. The dominant players in the industry are able to form partnerships with related companies both up and down the industry chain to hedge price fluctuations. New market entrants lack comparable capabilities and thus are less competitive.

## NOCO-NOCO'S BUSINESS

*Unless the context otherwise requires, all references in this section to the "Company," "we," "us" or "our" refer to the business of noco-noco and its subsidiaries prior to the consummation of the Business Combination, which will be the business of the PubCo and its subsidiaries following the consummation of the Business Combination.*

### Overview

We are an early-stage decarbonization solution provider in Asia, aiming to primarily engage in (i) the leasing of battery products, including batteries and BEVs to commercial transportation companies, and of ESS to renewable power plants and other power plants requiring grid stabilization and backup power; and (ii) carbon abatement solutions for landowners and carbon credit sales.

We operate a unique own-and-lease business model where we manufacture, upon our clients' requests, our battery products through OEMs and lease them to our clients. The own-and-lease business model, as compared to sales of battery products, helps our clients save upfront investment and operation capital expenditure. Under such business model, we also partner with automakers and OEMs to conduct our leasing business in the regions where our partners operate, to protect ourselves from capital, operational, and local regulatory risks. For details, see "*—Our Decarbonization Solutions—Own-and-Lease of Battery Products.*"

We rely on our exclusive license-in agreement with 3DOM Alliance to utilize its state-of-the-art intellectual property and technologies to develop and manufacture our own battery products and services. See "*—Relationship with 3DOM Alliance.*" These state-of-the-art technologies enable us to produce batteries that we believe, as compared to conventional batteries, are designed to have a longer lifespan and higher reliability, and be more resistant to high operating temperature and thermal runaways. Our unique position with 3DOM Alliance as the exclusive licensee of its patents and technologies also allows us to take full advantage of the technology advancement that 3DOM Alliance has developed or licensed in through various cooperation and collaboration arrangements with leading universities and professors for our battery products. To scale our business and to improve our productivity, we also entered into several MOUs with our strategic partners, including primarily well-known automakers and battery manufacturers. See "*—Partnerships.*"

In addition, we engage in carbon abatement solutions and carbon credit sales. We work with our landowner clients to reduce their excessive carbon emissions and generate carbon credits. These carbon credits can be sold back to the regulators, or on the secondary market through our network of clients, the revenue generated from which is shared between our landowner clients and us. We sell the carbon credits to companies in need of carbon offsets through our active marketing efforts. We also cross-sell them to our battery business clients to offset carbon emissions from their operations, in addition to leasing them our battery products. As our battery business clients are generally under pressure to decarbonize their business operations, our cross-selling of carbon credits in addition to our leasing business will increase our competitiveness and generate synergies among our product and service offerings. For details of our carbon abatement solutions and carbon credit sales business, see "*—Our Decarbonization Solutions—Carbon Abatement Solutions and Carbon Credit Sales.*"

Leveraging the state-of-the-art technologies of our battery products, our unique own-and-lease business model as well as the cross-selling to our battery business clients of carbon credits gained through our carbon abatement solutions, we believe we are well positioned to capitalize on the global momentum towards electrification of transportation and the global carbon emission reduction goal.

### Our Market Opportunities

Our businesses focus on two industries: (i) battery and BEV industry, and (ii) carbon abatement solutions and carbon credit sales. The two industries have been experiencing and are expected to further experience strong demand, driven by global climate change concerns and governmental and supra-national forces.

### ***Tremendous market potentials for lithium-ion batteries***

Globally, there is an accelerating transition of transportation from internal combustion engine vehicles, or ICE vehicles, to BEVs, driving demand for clean, highly reliable and long-life batteries and BEVs incorporating such batteries. The growing BEV market in Asia Pacific is one of the major factors that is contributing to the surging demand for lithium-ion batteries. Asia Pacific as a global manufacturing hub has also contributed to the increased adoption of facilities and equipment that are powered by lithium-ion batteries. Moreover, the region has the largest population in the world, leading to expected high volume sales of consumer electronics, such as mobiles, laptops, and appliance, that utilize lithium-ion batteries. In addition, reliance on fossil-fuel based power generation is decreasing due to the increasing installation of renewable power plants. Lithium-ion batteries are also increasingly utilized for providing backup power supply for commercial buildings, data centers, and institutions.

With increasing consumer acceptance of BEVs and additional regulatory support for BEV sales, the global EV battery installed capacity is expected to reach 1,898.1GWh by 2026, with a projected CAGR of 39.6% between 2022 and 2026, according to Frost & Sullivan. In addition, the newly installed capacity of global ESS battery was 53.5GWh in 2021. Similar to EV battery, the demand for ESS battery is also expected to increase exponentially in the coming years. According to Frost & Sullivan, the newly installed capacity of ESS battery is expected to reach 682.6GWh in 2026, with an estimated CAGR of 58.5% between 2022 and 2026.

### ***The approaching deadlines for carbon emission reduction goal bring opportunities for the carbon credits market***

Demand for carbon credits has been rising as the carbon reduction target deadlines are approaching. The United Nations Intergovernmental Panel on Climate Change (UNIPCC) has set 2030 as the deadline for carbon emissions to be halved, and 2050 as the deadline for nations to achieve zero carbon. Likewise, Australia has set the goal of reducing its net greenhouse gas emissions to zero by 2050. PNG has set the target of 50% reduction in emissions by 2030 and carbon neutrality by 2050. In order to achieve these targets, carbon credits are an essential part of the comprehensive global carbon abatement solution. According to Frost & Sullivan, the market size of carbon credit trading industry by transaction amount will surge from \$851.0 billion in 2021 to \$6,730.1 billion in 2026 at a CAGR of 51.2%

While it is critical to promote the electrification of transportation and the use of clean energies, the relevant policies and measures have been implementing slowly. As a result, programs to limit or prevent carbon emissions have gained much attention worldwide and of certain critical international institutions, such as the United Nations. Meanwhile, as more indicators of global warming have emerged, governments are stepping up to require clean energy regulatory bodies to assess carbon sequestration programs, receive program applications, and issue carbon credits based on the United Nations Framework Convention on Climate Change (UNFCCC) rules.

For more details of the market opportunities, entry barriers and market size, see *“Industry Overview Relating to noco-noco’s Business.”*

We anticipate taking advantage of the global transition to clean energy transportation and the global carbon emission reduction goal to enjoy the opportunities brought by these markets with great potential. Capitalizing on the advanced technologies exclusively licensed-in from 3DOM Alliance, our unique own-and-lease business models, and strategic partnerships with market players, we believe we are well prepared to successfully operate in our target markets and achieve considerable business growth.

### **Our History**

Leveraging the intellectual properties and technologies exclusively licensed-in from 3DOM Alliance, our majority shareholder, we began to operate as a decarbonization solution provider headquartered in Singapore in 2019. The list below provides an overview of key events in our history:

- 2019 3DOM (Singapore) Pte. Ltd. was established in Singapore by 3DOM Alliance to carry out its marketing, fundraising and commercial business activities.
- 2021 3DOM (Singapore) Pte. Ltd. entered into an exclusive license-in agreement with 3DOM Alliance to be entitled to use certain critical intellectual property rights worldwide.

3DOM (Singapore) Pte. Ltd. entered into two potential reverse takeover transactions with two companies listed on The Singapore Exchange Limited (“SGX”), upon the completion of which 3DOM (Singapore) Pte. Ltd. would be listed on the SGX. The first reverse takeover transaction was pre-maturely terminated upon mutual agreement because both parties had significant differences in perspective and approaches in connection with the proposed reverse takeover. The second reverse takeover transaction was pre-maturely terminated upon mutual agreement due to the listed company’s failure to meet some of the conditions required for the extension of time granted by the SGX for the submission of the proposed transaction and trading resumption, in which the continuation of the proposed reverse takeover would pose risks to noco-noco.

2022 3DOM (Singapore) Pte. Ltd. was renamed as noco-noco Pte. Ltd.

noco-noco entered into several MOUs with automakers or OEM partners to either scale our battery business or to improve battery manufacturing productivity.

2023 noco-noco set up a subsidiary in Australia to carry out its carbon abatement solutions and carbon credit sales business.

The figure below illustrates our organizational structure before the Business Combination:

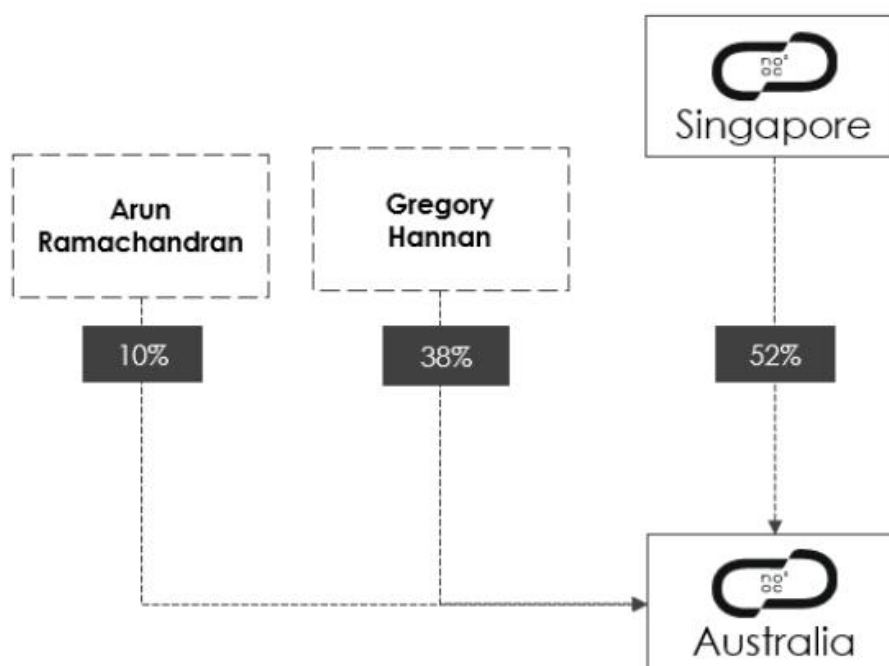

### Our Competitive Strengths

We believe the following competitive strengths have contributed to our maturity and will help drive our growth in the future.

#### ***State-of-the-art Technologies Enables Highly Reliable and Longer-lasting Battery Products***

We license in a series of state-of-the-art patents and technologies from 3DOM Alliance, our majority shareholder, with respect to, among others, battery cascade use, battery management system, battery cell and pack model, and battery units. For details of our licensing-in arrangement with 3DOM Alliance, see “—*Relationship with 3DOM Alliance.*” These technologies enable us to produce batteries that, as compared to conventional batteries, are designed to have a longer lifespan and higher reliability, and be more resistant to high operating temperature and thermal runaways. For example, due to the higher porosity and uniformly spaced 3-dimensional structure of the pores of our separators, ionic conductivity becomes more efficient, thus reducing the formation of dendrites, which are the major source of battery unsafe risks, such as fire, quick deterioration, and poor resilience to high temperatures. Further, with the high porosity, our separators are much more wetttable than conventional separators. This enables the use of high-viscosity, low-volatility electrolytes in our batteries, increasing their resistance to fire or degradation from heat and high temperatures. Thus, our batteries can also avoid the rapid deterioration resulting from intense heat conditions, which cause problems to conventional batteries with low-viscosity electrolytes.

In addition, our unique position with 3DOM Alliance as the exclusive licensee of its patents and technologies allows us to take full advantage of the technological advancement that 3DOM Alliance has developed or licensed in through various cooperation and collaboration arrangements with leading universities and professors for our battery products. For example, Professor Kiyoshi Kanamura, a leading Japanese authority in battery research and the chief technology officer of 3DOM Alliance, licensed the exclusive right of his patent “secondary battery separator and lithium secondary battery using the separator” to 3DOM Alliance in October 2011. This critical patent enables 3DOM Alliance to develop, and us to use, manufacture, and lease, our highly-reliable and long-life batteries. 3DOM Alliance also received technical support from a well-known university in Japan for its R&D of highly-reliable and long-life battery separators, supplementing 3DOM Alliance’s R&D capabilities. The cooperation with and support received from leading universities and professors is a recognition of 3DOM Alliance’s R&D capabilities in the battery industry, which enables us to produce highly-reliable and long-life batteries to better serve our clients’ interests.

For more details regarding the technologies that are applied to our battery products, see “—Our Pipeline Products and Services.”

#### ***Unique Own-and-Lease Business Model Makes Our Battery Products Cost-effective***

We operate a unique own-and-lease business model where we manufacture upon our clients’ requests, through OEMs, our battery products, including batteries, BEVs and ESS, and lease them to our clients, primarily consisting of commercial transportation companies, renewable energy plants and other power plants requiring grid stabilization and backup power in Asia. Traditionally, it would cost tremendous upfront capital expenditure and operation expenses for companies to purchase the battery products. However, under our own-and-lease business model, our clients only need to lease our battery products without having to purchase them, enabling our clients’ operation of BEVs and renewable energy plants more affordable. In addition, due to the advanced technology licensed-in from 3DOM Alliance, our batteries generally have a lifespan doubling that of conventional batteries, which indicates our batteries generally have approximately 30% to 35% lower price per cycle as compared to conventional batteries. Based on an internal evaluation, our X-SEPA battery with a 1C rate was tested over 4,500 cycles, and by applying the square root law to the test results, was found to be able to continue for 6,000 cycles before decreasing to a state of health (“SOH”) of 60%. A similar battery using a conventional separator, however, can last only 2,800 cycles before decreasing to an SOH of 60%. Evaluations in March 2023 produced more impressive results, with the life of our X-SEPA battery achieving 6,400 cycles at a higher SOH of 70%. Recent evaluations in April 2023 showed that our X-SEPA battery equipped with high temperature-resistant electrolyte was found theoretically possible to achieve approximately 9,000 cycles before decreasing to an SOH of 60%. The longer lifespan of our batteries also entitles our batteries to have two useful lives—our batteries can be used in BEVs for e-motorbikes, e-vans, e-buses, and e-trucks in their first life cycle (typically for lease up to eight years), and then in ESS for renewable power plants and other power plants requiring grid stabilization and backup power in their second life cycle (typically for lease up to ten years). This cascade usage model, with the long-term instalment of lease payments, is expected to help us attract clients whose operation is capital intensive.

As high capital expenditure is a major deterrence to the electrification of the transportation industry and also the transformation from fossil fuel power to renewable power, we believe our own-and-lease business model is essential to accelerate the transitioning from ICE vehicles to BEVs and the universal use of ESS to support and optimize renewable power generation.

For more details of our own-and-lease business model, see “—Our Decarbonization Solutions—Own-and-Lease of Battery Products.”

#### ***Strategic Cooperation and Partnerships with Market Players***

We have entered into a series of MOUs with well-known automakers and OEM partners to establish strategic business partnerships, with the ultimate goal of deploying our batteries in certain of their forthcoming battery powered EVs. For example, we have entered into an MOU with a global, leading automobile manufacturer based in China, to jointly develop commercial BEVs equipped with our batteries; an MOU with EV Dynamics (Holdings) Ltd (“**EV Dynamics**”) to carry out a carbon-free bus leasing business to EV Dynamics’ existing and new clients; and an LOI with B-ON K.K. (“**B-ON**”) to employ our battery cells for its 3- and 4-wheeled electric light commercial vehicles. We believe the successful joint development of battery technologies as well as the incorporation of our batteries into well-known automakers’ vehicles will enormously expand our business and operations as well as enhance our brand name.

In addition, we intend to cooperate with an e-waste recycling service provider to collect our used batteries to synergize with our carbon abatement solution business. For more details regarding our strategic partnerships with market players, see “—Partnerships.”

#### ***Carbon Abatement and Credit Generation Capability Add Value to Our Leasing Business***

We assist our clients, primarily landowners of forests, mangrove, bushland or land of similar kinds, to reduce their carbon emissions or absorb carbon, and earn carbon credits generated from the carbon abatement projects. Specifically, we plan methodologies of reducing and/or removing carbon emissions while creating revenue by operating a general carbon credit account, procuring carbon credits through submission to regulators, and securing subsequent buyers for sales of carbon credits, leveraging our information technology, science and mapping capabilities. We typically form a joint venture or partnership with our clients to carry out the carbon abatement projects. When certain requirements and criteria of carbon emissions are met, our clients can apply for carbon credits from government-introduced regulators. These carbon credits can be sold back to these regulators, or on the secondary market through our network of clients, revenue generated from which is shared according to a pre-agreed ratio between our landowner clients and us. For details of our carbon abatement solutions and carbon credit sales, see “—Our Decarbonization Solutions—Carbon Abatement Solutions and Carbon Credit Sales.”

In addition, leveraging our carbon credits generation capability, we are able to cross-sell the carbon credits generated through our carbon abatement projects to our battery product clients, who are keen to reduce their carbon emissions generated during their operations. As these clients are typically under pressure to decarbonize their business operations, our cross-selling of carbon credits in addition to our leasing business we believe will increase our competitiveness and generate synergies among our product and service offerings. In particular, with our carbon credit generation capability, we are able to provide leasing services and carbon credit sales in a bundle, on the one hand, helping our battery product clients to offset the carbon emissions generated by their operations, and on the other hand, improving our clients’ stickiness and generating additional profits. The synergies between our two business segments earn us both preference by our clients and strategic cooperation opportunities. For example, B-ON entered into an LOI with us, intending to cooperate on commercial car lease with available carbon credits. As zero carbon has become a global goal and international tradability of carbon credits has become available and popular, we believe we are well positioned to potentially reap substantial returns from the synergies and cross-selling between our battery business and carbon credits business.

#### ***Experienced Management and Synergy with 3DOM Alliance***

We are led and influenced by an experienced CEO, Mr. Masataka Matsumura, who is deeply rooted in the battery industry. Mr. Matsumura’s deep business insights have driven the sustainable development of our strategic business direction. His strategic vision and thorough understanding of the battery industry helps us make crucial business decisions based on market trends and development. For details of Mr. Masataka Matsumura’s experience, see “—Management of PubCo Following the Business Combination—Director Nominees and Executive Officers.”

Since our inception, we have received strong support from, and achieved great synergy with, our majority shareholder, 3DOM Alliance. 3DOM Alliance is a forerunner in the R&D of battery technologies, including battery separators and lithium-ion batteries, which has been named as an innovation project by the New Energy and Industrial Technology Development Organization for two consecutive years. Benefiting from the market recognition of the “3DOM” brand, we believe we are well positioned to promote our service offerings among our clients and differentiate ourselves from our competitors.

#### **Our Growth Strategies**

To achieve our mission and grow our business, we plan to pursue the following strategies.

### ***Cooperate with Market Players to Customize X-SEPA Separators***

We plan to establish a collaboration business model with automakers and battery manufacturers to produce high-tech separators, the “X-SEPA,” leveraging on the new separator technology licensed from 3DOM Alliance. For details regarding the advanced technologies of X-SEPA separators, see “—Our Pipeline Products and Services—X-SEPA Separator.” X-SEPA separators have the unique feature of consisting of multiple layers with different porosity joined together as one. This multi-layer technology is expected to enable production of durable high torque batteries and fast charging batteries, solving the two pressing challenges that other battery manufacturers face today. In addition, as the size and density of pores of the XEPA separator can be pre-calculated and calibrated in the manufacturing process, we are able to customize separators with particular features that satisfy the specific performance characteristics required by our clients. The unique methodology by which “X-SEPA” is manufactured will enable us to produce battery products with particular specifications to cater to our clients’ different and evolving needs. Capitalizing on the advanced X-SEPA separator technology, we plan to (i) partner with automakers and battery manufacturers to improve our productivity to customize battery products to accommodate our clients from a wide array of industries and (ii) spread this advanced technology in the automobile and battery industries to solve the pain points of end users and make us an industry leader.

### ***Expand Our Footprints in Selected Countries in Asia***

According to Grand View Research, the Asia market accounted for over 40.0% of the global lithium-ion battery market in 2021, and transportation vehicles in Asia, including 2-, 3- and 4-wheelers, are facing increasing regulatory pressures to decarbonize, there is great market potentials for clean, highly reliable and long-life batteries and BEVs. To seize the market opportunities, we plan to commence our operations in selected countries in Asia, including Singapore, Thailand, the Philippines, and Indonesia. We expect to enter into joint ventures with local partners in those selected countries to operate our battery product leasing business, with a view to reducing upfront risk capital and complying with local regulations with the assistance of local partners. For example, we plan to partner with EV Dynamics to lease e-buses incorporating our batteries in the Philippines to gradually replace their popular means of public transportation, Jeepneys, for mass transportation, as a national solution to reduce carbon emissions in the Philippines.

In the future, as our battery business grows, we also plan to expand our business of carbon abatement solutions and carbon credit sales into selected countries in Asia, including Indonesia, the Philippines, and Thailand, to achieve synergies with our battery business. We are currently actively searching for and talking to local partners in these countries that share similar goals for decarbonization and carbon credit solutions.

### ***Provide Efficient and Affordable BEVs to Commercial Transportation Companies***

Currently, there is an accelerating transition from ICE vehicles to BEVs in the transportation sector in the Asia. Therefore, there is a high demand for commercial transportation companies to replace their existing ICE vehicles with BEVs. However, commercial transportation companies require intensive upfront investment and cash flow for their daily operations. In addition, they are under great pressure to reduce their carbon emissions to comply with local regulations. To benefit from this transition and the potential market demand, we plan to lease efficient and affordable BEVs to these commercial transportation companies so that they can transition to clean transportation and achieve their carbon emission reduction goals successfully. Initially, we will target, among others, logistics companies which offer transportation as a service, last-mile e-motorbike/bicycle-sharing companies, as well as companies which operate their in-house transportation system for internal needs. As our licensed-in advanced technology can be used to produce longer-lasting batteries with higher reliability, which will in essence result in cost-effective and durable BEVs, together with our unique own-and-lease business model, we believe we are able to outperform our competitors to attract a large number of commercial transportation companies. In addition, as the transition to clean transportation foresees a huge market and the deadlines for global zero-carbon goals have been approaching, we expect to capture the huge opportunities in the commercial transportation sector by providing efficient and affordable BEVs to achieve economies of scale.

### ***Our Decarbonization Solutions***

We are an early-stage decarbonization solution provider in Asia, aiming to primarily engage in (i) the leasing of battery products, including batteries and BEVs to commercial transportation companies, and of ESS to renewable power plants and other power plants requiring grid stabilization and backup power; and (ii) carbon abatement solutions for landowners and carbon credit sales.

### ***Own-and-Lease of Battery Products***

We operate a unique own-and-lease business model where we manufacture, upon our clients' requests, our battery products through OEMs, including batteries, BEVs and ESS, and lease them to our clients, primarily consisting of commercial transportation companies, renewable energy plants and other power plants requiring grid stabilization and backup power in Asia. Traditionally, it would cost tremendous upfront capital expenditure and operation expenses for companies to purchase the battery products. However, under our own-and-lease business model, our clients only need to lease our battery products without having to purchase them, enabling operation of BEVs and renewable energy plants more affordable. Alternatively, our clients are also able to place orders to customize their battery products with specific specifications using the licensed-in X-SEPA separator technology. See "*—Our Pipeline Products and Services—X-SEPA Separator.*" We expect to generate revenue from our leasing business of battery products since the third quarter of 2023.

#### ***Leasing of Batteries and BEVs***

We plan to partner with automakers and manufacturers to conduct our leasing business of batteries and BEVs. We plan to cooperate with automakers as OEMs to produce BEV bodies upon orders placed by our clients to satisfy their demand. We also plan to engage battery manufacturers as OEMs for the mass manufacturing of our highly reliable and long-life batteries, which will be applied to our BEVs. Our BEVs are expected to be leased to our clients at a cost-effective rate to attract more clients and achieve our competitiveness among our competitors. These BEVs may include e-buses, e-vans, e-trucks, e-motorbikes, and last-mile delivery vehicles. We expect to focus our operations in the Southeast Asia and South Asia, including Thailand, the Philippines, Indonesia, India, and Singapore. In addition, we plan to leverage our in-house battery management system ("BMS") integrated with data process and mesh networking technologies to optimize energy usage of our battery products and to develop intelligent batteries.

#### ***Leasing of ESS***

We plan to lease our ESS incorporating our highly reliable and long-life batteries to power producers, including renewable energy plants and other power plants requiring grid stabilization and backup power. We also expect to provide key technological solutions to help resolve battery-related issues in our clients' energy storage process. With our highly reliable and long-life batteries and systems that can monitor battery conditions and allocate batteries for primary or secondary use, we believe our clients will be able to lower the costs of their energy storage solutions. In addition, we plan to explore together with our clients on opportunities to apply our batteries to a broader coverage of energy storage, including developing battery systems for the electrification of commercial vessels, and using battery tankers to transport energy from offshore farms to onshore ones.

### ***Carbon Abatement Solutions and Carbon Credit Sales***

We provide our carbon abatement solutions to help our clients reduce their excessive carbon emissions and generate carbon credits. Specifically, we plan methodologies of reducing and/or removing carbon emissions while creating revenue by operating a general carbon credit account, procuring carbon credits through submission to regulators, and securing subsequent buyers for sales of carbon credits, leveraging our information technology, science and mapping capabilities. We typically form a joint venture or a partnership with our landowner clients to carry out the carbon abatement projects. See "*—Our Decarbonization Solutions—Carbon Abatement Solutions and Carbon Credit Sales—Key Terms of Carbon Abatement Project Agreements*" for more details regarding the arrangements of our carbon abatement projects.

We undertake extensive geography survey mapping to create an overlay of the potential target areas, and identify existing and new activities in land, vegetation, crops and others to analyze their carbon abatement potentials. By using carbon-based feasibility studies, geo-fencing and land analysis, we map the farming enterprise and calculate the current emissions. For example, we conduct on-ground site measurements combined with satellite mapping to mark the area that can be covered under subsequent applications, and assess the current status of the vegetation and carbon capture and prepare a roadmap for future development of the area to further enhance the carbon absorption potential. Thus, we can project the reduction in emissions based on each modeled, recommended change from the initial farm carbon deficit to increase value for the project by creating new registerable carbon credits. Initial set up costs, including mapping and feasibility study costs, are disbursed by the landowners. Subsequently, we prepare an application for each carbon abatement project with the relevant government regulators, which identifies the specific land and provides extensive mapping data. Upon the submission of the application, the regulators will determine the value of the carbon abatement projects based on the application material and allocate a certain amount of carbon credits based on the mapping, type, volume and lifetime of the land.



Our carbon abatement projects primarily include carbon farming projects, deforestation avoidance projects, and rural afforestation projects. Carbon farming projects use farming in a way that reduces greenhouse gas emissions or captures and holds carbon in vegetation and soils. We provide consultancy and assistance to landowners while working cohesively to set up and commence carbon farming activities to reduce carbon emission and earn carbon credits. For deforestation avoidance projects, we work with landowners to promote agricultural planning and production that avoids tree-clearing, advocating stronger biodiversity to protect rural habitat. In parallel, we campaign for a halt to deforestation across the Asia-Pacific. A reforestation and afforestation project involves planting trees in agricultural areas. In doing so, the project helps to reduce the amount of greenhouse gas entering the atmosphere, as carbon stock remains stored in the trees while they grow.

We also execute for our clients the sales of their carbon credits generated during the process of carbon abatement projects. When certain requirements and criteria of carbon emissions are met, our clients can apply for carbon credits from government-introduced regulators. These criteria include definitive action plans to re-afforest the land tracts, conversion of methane generated from livestock in the farms into an alternative energy sources, and implementing a consisting clearing and pruning of grassland farms to avoid savannah burning from dry grass, to name a few. The carbon credits can be sold back to the regulators, or on the secondary market through our network of clients, revenue generated from which is shared according to a pre-agreed ratio between our landowner clients and us. We sell the carbon credits to companies in need of carbon offsets through our active marketing efforts. We also cross-sell these carbon credits to our battery product clients, in addition to leasing them our battery products.

Our business of carbon abatement solutions and carbon credit sales currently primarily operates in Australia and PNG, and expects to expand into Indonesia, the Philippines, and Fiji in the future. According to the relevant laws and regulations in Australia and PNG, no specific license is required to conduct the business

#### *Australia*

In Australia, we offer carbon abatement projects using a variety of agricultural methods that sequester atmospheric carbon in soil, crop vegetation, and biomass. Our solutions include storing carbon in their soils, planting native trees and shrubs, managing stock to allow native forest to regrow, beef herd improvement, and reducing nitrous oxide emissions from irrigated crops. With these carbon-neutral effects, we can assist these landowners to set up ERF projects and apply for ACCUs. The ACCUs can be used by landowners to offset their carbon emissions, are tradable in the secondary markets, and can be sold back to the CER, the authority that administers the ERF which supplies ACCUs.

#### *ERF Projects*

We submit for individual carbon project on the ERF government portal for approvals of issuance of an ERF carbon contract or credits. We are entitled to conduct carbon abatement projects on the sites within Australia and PNG and can claim carbon credits for emission abatement achieved by such projects.

Carbon credits are issued upon acceptance of the carbon abatement project by the CER. We are responsible for facilitating the processes of auditable reports, carbon project registrations, carbon abatement contracts and other display information required for the issuance, marketing, auditing, and accounting of carbon credits through the Australian National Registry of Emissions Units for auction or re-sale in the carbon market.

We can sell the carbon credits to third parties via auction or direct sales in the carbon market. We can use the Carbon Market Institute Carbon Marketplace for auction of the carbon credits, or sell the carbon credits directly to third parties through our worldwide network that are under pressure to reduce carbon emission for direct sales. As of the date of this proxy statement/prospectus, we had contracted and submitted six carbon abatement projects to the CER, totaling 91,520 million hectares and are estimated to produce around 1.37 million ACCUs.

The carbon market in PNG operates differently to that of the Australia as a result of minimal regulatory frameworks in place. There are voluntary carbon schemes and governmental schemes in PNG, which are agreements negotiated directly with landowners with little governmental intervention.

Following the 26th United Nations Climate Change Conference of Parties in Glasgow (COP 26), Australia, Fiji and PNG have collaborated to generate high-integrity carbon offsets in the Indo-Pacific market by virtue of the Indo-Pacific Carbon Offsets Scheme. See “—*Government Regulations.*”

As of the date of this proxy statement/prospectus, we have contracted to deliver over 30 carbon abatement projects in PNG, totaling 5.3 million hectares and are estimated to produce around 159 million tons PNG carbon credits. In addition, as of the same date, we had successfully submitted 11 of these carbon abatement projects, totaling 4.3 million hectares and producing around 128 million carbon credits.

#### *Key Terms of Carbon Abatement Project Agreement*

We typically form a joint venture or a partnership with our landowner clients to carry out the carbon abatement projects in Australia and PNG, the key terms of which are set out below:

*Purpose of the joint venture or partnership.* The parties form a joint venture or a partnership to combine expertise, management and property resources to support reduction of emissions and produce additional revenue for our clients through the issue of carbon credits for sale on the domestic and international markets.

*Service term and renewal.* The agreement typically remains in full force and effect from its date up to 2030 (the “**Initial Term**”). Upon the expiration of the Initial Term, the agreement shall be automatically renewed each time for a successive five-year period until 2050, subject to either party’s prior written notice of termination before the expiration of the Initial Term or any renewed term.

*Our services.* We provide geo-survey services and map all carbon sequestration capabilities of our clients for the purposes of identifying all carbon abatement capabilities of any existing pastured land, vegetation, crops, mangrove, forests or grasslands that may exist on land provided by the clients and to be managed by us. In particular, our services include carbon-based feasibility studies, geo-fencing and analysis of the land for the identification of carbon emissions and submission of contracts and other governmental documents for the issue of carbon credits.

*Regulatory submission and approval.* As the carbon abatement manager and registration agent, we manage the regulatory submission process as well as domestic and international sales and marketing of the carbon credits derived from the carbon abatement projects. In particular, we provide and operate an online portal with the CER, and provide access to government audits and carbon credit certificate issues on account. The government typically issues a valid carbon credit certificate upon an approved carbon project contract within 90 days of submission.

*Sales of carbon.* We sell the carbon credits to third party companies via auction or direct sales in domestic markets, or in international markets through our commercial relationships abroad.

*Distribution of carbon credit sales revenue.* The net proceeds, after deduction of operating expenses and disbursements, are split between the parties at a pre-agreed percentage. Typically, 20% to 60% of the net proceeds will be distributed to us with the rest 40% to 80% distributed to our clients and project officers (if any) as a whole.

*Payment schedule.* Our landowners clients and we agree to a guaranteed base price set for an initial term. We arrange to make payments within three working days of the initial deposit made by the government or from international exchange market or direct sales buyers. When profits generated from the carbon abatement projects exceed the base price by a pre-agreed percentage, our clients will receive additional payment.

*Exclusivity.* Due to the specialized nature of the carbon abatement industry and the longevity of our participation in the project, the agreement is entered into on an exclusive basis.

*Confidentiality.* Neither party is entitled to disclose any confidential information relating to the other party's business to any person or entity without the express written consent of the affected party, except as required by law.

*Termination.* Either party may terminate the agreements by prior written notice to the other party at least 30 days before (but in no case more than 60 days before) the expiration of the Initial Term or any renewed term. At any time, the agreement may also be terminated by mutual written consent of the parties. When the agreement expires or terminates, all parties' obligations under the agreement with respect to the operation and administration of the joint venture shall be immediately terminated.

### Our Pipeline Products and Services

Our primary pipeline products include (i) X-SEPA separator and (ii) lithium manganese iron phosphate (LMFP) cathode.

#### X-SEPA Separator

Our batteries equipped with X-SEPA separator, developed by 3DOM Alliance after eight years of research and development, is more reliable and longer-lasting compared with conventional batteries, due to our X-SEPA separator's high and uniform porosity, high liquid absorption, and high heat resistance. Below is the illustrative picture of the structure of our batteries using X-SEPA separators:

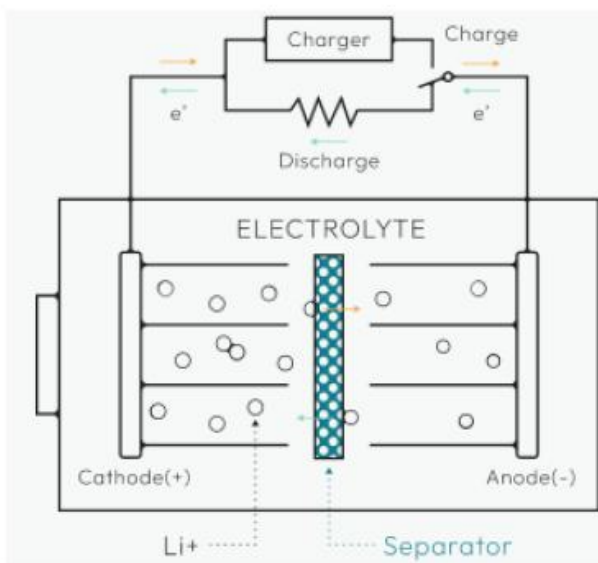

Our X-SEPA separator has the unique advantage of high and uniform porosity, which is the key to high ionic conductivity, resulting in long battery lifespan and the avoidance of dendrite formation, which is the main cause of fire and explosions and fast battery deterioration. X-SEPA separator is capable of having more than 70% porosity, compared to around 40% porosity for conventional separators. Conventional separators are made through a uniaxial stretching method, which can only produce irregularly shaped and randomly distributed pores by tearing. In our case, we are able to produce, through 3DOM Alliance, pores that are uniform and with high density through unique manufacturing process using polyimide precursor with beads and put through a process of drying and detachment, imidization and thermal removal of the beads, hence creating pores that are regular in shape and evenly distributed. Below is the illustrative picture showing the different production methods between a general-purpose PP separator and our X-SEPA separator:

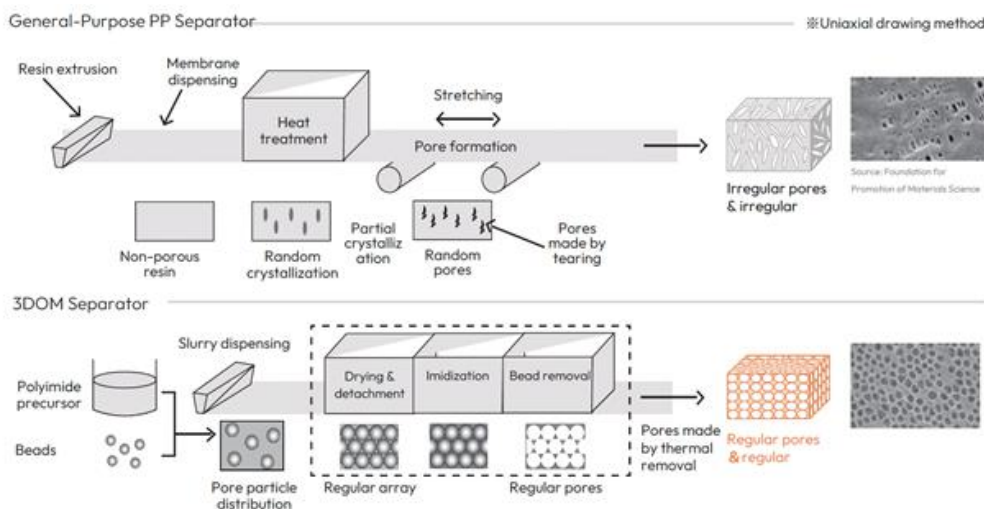

The unique methodology of producing X-SEPA separators enables us to offer customized separators with pre-specified pore sizes and density, which helps achieve desired battery performance parameters. Furthermore, through a 3-layer die configuration, we are now able to offer separators with 3 layers with the middle layer being of low porosity and the two outer layers of high porosity. The middle layer can provide strength to the overall separator, whilst the outer layers of high porosity can increase the lifespan and make possible high C charge/discharge rates for the battery without causing damage and deterioration. Below is the illustrative picture of the structure of our X-SEPA separators:

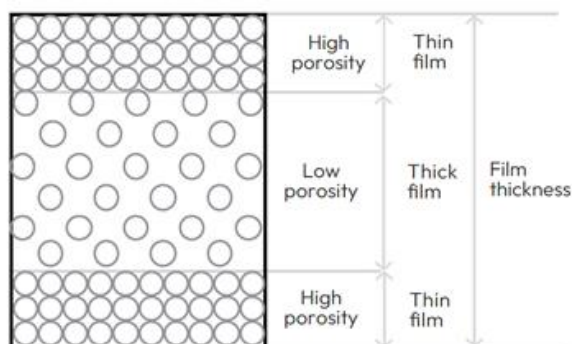

In addition, X-SEPA separator has a high wettability due to its high and uniform porosity. This enables us to use high viscosity electrolytes, which are non-volatile and can prevent explosion. Such electrolytes, which have up to 30 times more viscosity than conventional electrolytes, are also less prone to evaporation at high temperatures, and thus can enhance battery performance. A 25mAh nickel manganese cobalt (NMC) battery, with non-volatile electrolyte and using X-SEPA separator, can last 600 cycles to the point when capacity retention drops to 60% at a temperature of 60 degrees Celsius and at 0.5C charge/discharge rate. A similar battery without X-SEPA separator can last only 370 cycles in the same condition. X-SEPA separator is hence essential for producing batteries which can withstand very high operating temperature conditions without fast deterioration of battery function.

Furthermore, our batteries, with the X-SEPA separator fitted in, are found to be high heat resistant, have high reliability in abnormal conditions and a near doubling of lifespan of other batteries. Capacity retention of our battery with X-SEPA separator only falls to 60% after 7,300 cycles, at an operating temperature of 25 degrees Celsius and a 1C rate, whereas a battery without X-SEPA separator drops to 60% retention after 3,300 cycles in the same condition. If the operating temperature goes up to 45 degrees Celsius, our battery falls to 60% retention after 3,600 cycles whilst the other can last only 1,450 cycles. Nail penetration testing on the battery cell with a conventional separator had resulted in thermal runaway and venting, corresponding to European Council for Automotive R&D (“EUCAR”) hazard level 4, while testing on the battery cell equipped with our X-SEPA separator did not result in thermal runaway and produced no smoke or flame, corresponding to EUCAR hazard level 2.

The high uniform porosity of X-SEPA separator also makes it highly suitable for lithium-metal anode, solid-electrolyte batteries. A lithium-metal anode battery sample was developed and tested in July 2020, with successful achievement of 200 cycles for 400Wh/kg energy density. We expect the mass production of single layer separator to begin in the third quarter of 2023, and 3-layer samples have been provided for client testing since February 2023. Mass manufacturing of 3-layer separator is targeted to commence in the fourth quarter of 2024. The manufacturing of X-SEPA separators is expected to be carried out by 3DOM Alliance and OEMs.

Below is a diagram showing the differences between conventional batteries and our batteries using X-SEPA separators:

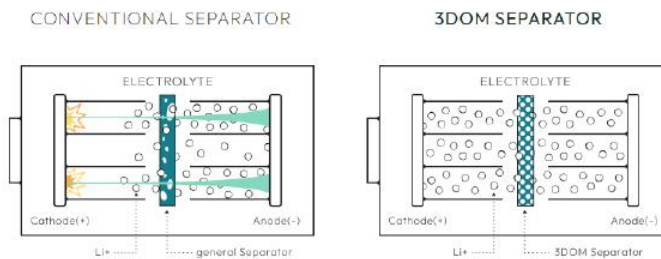

Material	polypropylene / polyethylene	polyimide
Pore structure	uneven and 2-dimensional	even and 3-dimensional
Porosity	about 40-50%	over 60%
Heatproof temperature	150 - 250 °C	400°C or higher

### Lithium Manganese Iron Phosphate (LMFP) Cathode

Lithium iron phosphate (LFP) batteries are increasingly used in place of nickel cobalt aluminum (NCA) and nickel manganese cobalt (NMC) batteries which are more expensive, but LFP batteries have the disadvantage of lower energy density. In 2014, 3DOM Alliance developed a battery using a cathode fabricated with lithium-manganese-iron-phosphate (LMFP), which has more energy density and cost less, as compared with LFP batteries. Our LMFP batteries developed by 3DOM Alliance have about 30% higher energy density than LFP batteries and a lifespan of about 6,000 cycles compared to 3,000 cycles for third party LFP batteries. Although the average cost of our LMFP batteries is higher than that of the LFP batteries, due to the much longer lifespan, cost of our LMFP batteries per cycle is about 35% lower. We expect to commence commercialization of the LMFP cathode in the fourth quarter of 2023.

### Relationship with 3DOM Alliance

3DOM Alliance is our majority shareholder which engages in the R&D of various battery technologies. The history of 3DOM Alliance can be traced back to 2011 when the patent of “secondary battery separator and lithium secondary battery using the separator” was granted by Japan Patent Office to Professor Kiyoshi Kanamura, and subsequently licensed exclusively to 3DOM Technology Inc., the predecessor of 3DOM Alliance. During 2015 to 2017, 3DOM Alliance was among the list of technology innovation projects and enjoyed a series of governmental and university support. In 2018, 3DOM Alliance began making samples of solid-state batteries, and later in the following year, delivered the first supply of batteries using its proprietary battery technology to a BEV maker. In 2019, 3DOM Alliance also began the development of application for ESS. In 2020, 3DOM Alliance installed a small-scale production line for its separator X-SEPA, producing lithium-metal anode battery samples for testing.

We entered into an exclusive, irrevocable license-in agreement with 3DOM Alliance, on November 22, 2022, enabling us to manufacture our battery products with 3DOM Alliance’s cutting-edge technologies. Pursuant to our agreement, 3DOM Alliance granted us certain of its proprietary and licensed-in patents and other intellectual properties, as well as confidential know-how and other information, relating to, among others, battery cascade use, battery management system, battery cell and pack module, leasing with carbon credit, business model task distribution equipment, battery unit, electronic equipment control equipment communication terminals and electronic equipment, degradation-based billing prediction, and degradation-based billing forecasting (“**3DOM IP Rights**”).

## **Key Terms of the License-in Agreement**

Below set out the key terms of the license-in agreement entered by 3DOM Alliance and us:

*Term:* The term of the license-in agreement is perpetual, unless terminated upon default, or upon bankruptcy or insolvency.

*Grant of license:* 3DOM Alliance grants us a worldwide, exclusive, irrevocable license on 3DOM IP Rights to make, import, export, use, or sell products which incorporates or is the result of the licensed 3DOM IP Rights (“**Licensed Product**”).

*Technical assistance:* 3DOM Alliance shall provide technical assistance for us to utilize 3DOM IP Rights.

*Right of first refusal:* We have the right of first refusal to enter into negotiations to license in any further intellectual properties from 3DOM Alliance that it owns or acquires, when 3DOM Alliance intends to license out its intellectual properties.

*Exclusivity:* 3DOM Alliance shall not practice or grant to any third parties any license to practice the 3DOM IP Rights within the scope of the license granted to us perpetually.

*Royalties:* We are obligated to pay 3DOM Alliance royalties quarterly within sixty (60) days after the end of each quarter, equal to three percent (3%) of the gross profit generated using each of 3DOM IP Rights. The royalty rate can be revised by mutual written consent. After the first anniversary of the effective date of the license-in agreement, either party shall have the right to negotiate to adjust the royalty rate annually.

*Termination:* Either party can terminate the license-in agreement when the other party fails to pay any amounts when due with a thirty (30) days’ written notice, or when the other party fails to perform any obligation and fails to cure within the sixty (60) days notice period. Upon the occurrence of any aforementioned event of default, the non-defaulting party shall deliver to the defaulting party a written notice of intent to terminate, such termination shall be effective upon the date set forth in such notice. 3DOM Alliance may also terminate the license-in agreement with a written notice upon our bankruptcy or insolvency.

*Assignment:* Any and all assignments of the license-in agreement or any granted rights by us are void, except for assigning (i) to any of our affiliates, or (ii) as expressly permitted under the agreement.

*Upfront payment:* We are obligated to pay a one-off, refundable upfront payment of \$30 million licensing fee to 3DOM Alliance. Such upfront payment shall be credited against any royalties under the agreement such that the amount of the upfront payment shall be deducted from the royalties when due and payable. In the event that the upfront payment has any remaining amount after the last deduction from the royalties at the end of a five-year period from the last instalment of the upfront payment, the remaining unutilized amount shall be refunded to us at our request. Pursuant to a supplemental agreement to the license-in agreement dated May 10, 2023 (the “**Supplemental Agreement**”), the upfront payment shall be payable over a series of instalments after the consummation of the Business Combination, in such amounts and pursuant to such repayment schedule as may be agreed between 3DOM Alliance and us. Both parties shall negotiate the installment plan in good faith, taking into consideration our working capital needs as well as our liquidity and available capital resources after the consummation of the Business Combination.

*Obligations related to commercialization:* We shall be responsible for obtaining all necessary governmental approvals for exercising the intellectual property rights under the license-in agreement, including the development, manufacture, distribution, sale and use of any Licensed Product, at our expense, including, without limitation, any safety studies. We shall have sole responsibility for any warning labels, packaging and instructions as to the use of Licensed Products and for the quality control for any Licensed Product. 3DOM Alliance agrees to provide reasonable assistance to our company, including through the provision of 3DOM’s know-hows, with regard to obtaining said approval, exercising the intellectual property rights, and conducting quality control. With regard to commercializing 3DOM IP Rights, we shall regularly coordinate and consult with 3DOM Alliance in developing and implementing our business plans for the earlier of the following periods: the first three years after the execution of the license-in agreement or upon the reasonable determination by 3DOM Alliance that such coordination and consultation is no longer necessary.

*Royalty-free license to improvements:* We shall own all the rights of the improvements to the Licensed Products it creates (the “**Improvements**”) to the extent that such Improvements are not contained within the scope of 3DOM IP Rights. We granted to 3DOM Alliance a non-exclusive, royalty-free license of the Improvements, strictly for 3DOM Alliance’s non-commercial research purposes, without limitation as to time or geographic area, with the right for 3DOM Alliance to sublicense to other non-profit institutions for their non-commercial research purposes.

*Government funding:* Our rights and obligations under the license are subject to change due to 3DOM Alliance’s obligations in connection with any funding or other support from an interested government.

## **Government Regulations**

### **Singapore**

#### Regulations on Environmental Protection and Resource Sustainability

The import, storage, usage, dealing and disposal of batteries in Singapore are regulated under several legislation in Singapore, including but not limited to the Environmental Protection and Management Act 1999 of Singapore (the “**EPMA**”) and the Environmental Public Health Act 1987 of Singapore (the “**EPHA**”), both of which and their respective subsidiary legislation are administered by the National Environmental Agency of Singapore (the “**NEA**”).

Under the EPMA, the importation of certain specified hazardous substances requires a license prior to doing so. The storage, use of and dealing with such hazardous substances must also be carried out in a manner that protects the health and safety of all persons as well as the environment. While our batteries do not contain any hazardous substances that are regulated under the licensing regime under the EPMA, we will continue to monitor for any manufacturing changes and battery developments in the future and will apply for such licensing as may be required.

Further, the disposal of obsolete and/or spent batteries and other constituent chemical waste products (collectively, “**Battery Waste**”) are regulated under the EPMA, the EPHA and the Resource Sustainability Act 2019 of Singapore (the “**RSA**”). Under the EPMA, we are not permitted to discharge or cause to be discharged Battery Waste and other polluting matters into any drain or land without the written permission of the NEA. In addition under the EPHA, we must store Battery Waste in a proper and efficient manner so as not to create a nuisance or to cause any risk, harm or injury to persons or is likely to pollute the environment, and must dispose of Battery Waste at authorized disposal facilities. The RSA also specifically provides that Battery Waste must be disposed via a waste collector or e-waste recycler that are each licensed under the EPHA.

#### Regulations on Workplace Safety and Health

The Workplace Safety and Health Act 2006 of Singapore (the “**WSHA**”) and its subsidiary legislation regulates the safety, health and welfare of persons at work in workplaces. It applies to all workplaces in Singapore (save for certain exemptions), and generally requires employers, occupiers and other stakeholders to uphold certain safety, health and welfare standards.

Under the WSHA, we are obliged to take reasonably practicable measures to ensure the safety and health of our employees, contractors, and direct or indirect subcontractors at work, including but not limited to maintaining facilities and arrangements for their welfare at work, adequate safety measures for machinery and equipment, and ensuring that such persons are not exposed to hazards in the processing, storage, transport and/or disposal of things at the occupied premises. We are required to maintain safety and health management systems, as well as continual monitoring for compliance. Additionally, we are required to take reasonably practicable measures to ensure that any access and/or egress points to the premises occupied by us (such as storage facilities), and all machinery, equipment or substance kept at the premises, are safe and pose no risks to the health of all persons within those premises.

#### Regulations on Fire Safety

The Fire Safety Act 1993 of Singapore (the “**FSA**”) regulates the arrangements for fire safety, fire hazards and fire prevention in premises located in Singapore. Because some of our batteries contain lithium compounds and other flammable materials, we may be required under the FSA to obtain a licence for the importation and/or transport of our batteries, as well as the storage of the batteries at storage facilities. Waste products generated from the Property that are deemed as flammable material must also be disposed in accordance with the storage license granted by the relevant authorities. We will apply for such license, if required, at a later time when such batteries are imported and/or transported in Singapore.

## **Australia**

The Australian Federal Government established the CER by virtue of the Clean Energy Regulator Act 2011 and Carbon Credits (Carbon Farming Initiative) Act 2011. The CER is the regulatory authority responsible for the determination of rules in relation to carbon abatement, administration of the ERF and engaging in government purchasing of emissions reduction. The carbon abatement project is solely governed by the Australian Federal Government.

The ERF was established by virtue of the Carbon Credits (Carbon Farming Initiative) Act 2011 and the Carbon Credits (Carbon Farming Initiative) Rule 2015. The CER administers the ERF by way of funding registered ACCUs. Registered proprietors of land and registered proponents are able to create value by exploiting existing land, reducing their carbon emissions or removing and storing carbon in vegetation and/or soil.

Eligible projects may earn one ACCU for every ton of emissions reduced, avoided, removed or stored.

The CER is the primary market for ACCU sales. Carbon credits can be sold to government contracts or via secondary market, which includes private speculation, private carbon commitments or to other proponents for their respective projects. There is currently no exchange for carbon credits to be traded. Australia is introducing the Australian Carbon Exchange (“ACE”) which will facilitate the purchase, sale and settlement of ACCUs. Whether the ACE will integrate with international markets is yet to be determined.

ACCUs are purchased and sold via the Australian National Registry of Emission Units (“ANREU”) with each unit being recorded on the registry. The ANREU is governed by the Australian National Registry of Emissions Units Act 2011 and the Australian National Registry of Emissions Units Regulations 2011. The registry monitors credits owned, transferred for income, cancelled or relinquished. Each registered proponent under the CER is required to be registered with the ANREU. Upon a successful application to the CER, the credits will be issued to the registered proponents registry account and be available for trading.

Australia is a party to the Indo-Pacific Carbon Offsets Scheme, which allows for credits obtained via carbon abatement projects to be openly traded between companies in the private sector.

## **PNG**

The current state of the laws and regulations regarding carbon credits and a carbon market in PNG is in a development phase and as such, lawmakers are having difficulties with forming the appropriate regulatory bodies and framework to ensure compliance with the Paris Agreement and its own constitution. The current regulation being Climate Change (Management) (Carbon Market) Regulation 2022 covers the rights to the carbon stored in PNG’s forests.

PNG currently has no compliant carbon market established. Given the developmental phase of the carbon market industry in PNG, there is a lack of legislation, policy framework and administrative agreements to participate domestically and internationally. PNG has created development authorization bodies to facilitate climate issues, inclusive of a carbon market. Currently, there is a moratorium on voluntary carbon contracts in PNG, due to further regulations being developed. Once the regulations are finalized, the voluntary carbon market will resume.

PNG is a party to the Indo-Pacific Carbon Offsets Scheme, which allows for credits obtained via carbon abatement projects to be openly traded between companies in the private sector.

## **Intellectual Property and Technology**

All of our current intellectual properties and technologies are exclusively licensed in from our majority shareholder, 3DOM Alliance, pursuant to a license-in agreement dated November 22, 2022. See “—*Relationship with 3DOM Alliance*” for more details.

These licensed-in intellectual property rights include five registered patent in Japan, the United States and South Korea. We also have 42 patents under application, five of which are under Patent Cooperation Treaty (“PCT”) application, with the remaining 37 patents under application in Japan, Singapore, European Patent Office, China, the United States, South Korea, Thailand and Taiwan. The licensed-in intellectual property rights also include four registered trademarks in Japan, two registered trademarks in Singapore, one trademark under application in Japan, one trademark under application in Singapore, and two trademarks under application in India. Our licensed intellectual property rights and technologies are mainly for battery cascade use, battery management system, battery cell and pack module, leasing with carbon credit, battery unit, degradation-based billing prediction, and degradation-based billing forecasting.



We protect our know-how, trade secrets and other confidential business information of any type by requiring our contractors, clients and others who develop intellectual property (including confidential information) in the course of their work for us.

## Customers

We currently do not have any customers as we have yet to commercialize our leasing services and other services. Our business primarily targets commercial transportation companies as well as renewable power plants and other power plants requiring grid-stabilization and backup power, that have environmental concerns, sustainability goals, and zero-emission mission. Based on our estimates of the market conditions and our operation status, we expect to commence our leasing business in the third quarter of 2023.

Current clients of our carbon abatement solutions business are primarily landowners in Australia and PNG.

## Competition

### *Battery and Energy Storage Industry*

The battery and energy storage industry is highly competitive, and new regulatory requirements for vehicle emissions, technological advances, and shifting customer demands are causing the industry to evolve towards zero-emission solutions. We believe that the primary competitive factors in the market include, but are not limited to:

- total cost of ownership (“TCO”);
- safety, reliability and quality;
- gravimetric and volumetric energy density;
- product performance and uptime;
- charging characteristics;
- technological innovation;
- comprehensive solution from a single provider;
- ease of integration; and
- service options.

Similar to traditional OEMs in the passenger vehicle market, incumbent commercial transportation OEMs are burdened with legacy systems and the need to generate sufficient return on existing infrastructure, which has created a reluctance to embrace new zero-emission drivetrain technology. This reluctance creates opportunity for us and has allowed us to gain a significant head start against our competition. We believe the global push for lower emissions combined with vast technological improvements in fuel cell and battery-electric powertrain technologies have awakened well-established battery technology companies and vehicle manufacturers to begin investing in zero-emission transportation. We expect an accelerating transition from ICE vehicle to BEVs in the commercial transportation sector in the next three years.

Our key competitors are leading battery technology companies. Our batteries have various advantageous features, including heat resistance, higher energy density, high charge rates, high discharge rates, long lifespan and improved reliability, which are suited for different needs and operating conditions and we believe will increase our market shares. For more details, see “—Our Competitive Strengths” and “—Sales and Marketing.”

### *Carbon Abatement Solutions and Carbon Credit Market*

In addition, we are also generating and providing carbon credits to companies who are under the pressure to decarbonize their business operations, such as logistics companies. See “—Carbon Abatement Solutions and Carbon Credit Sales” and “—Our Industry and Market Opportunity—The approaching deadlines for carbon emission reduction goal bring opportunities for the carbon credits market” for more details.

## **Partnerships**

We are currently in negotiation to formalize several strategical partnerships, mainly with automakers and battery manufacturers, to seek for more mutually beneficial business opportunities.

### ***EV Dynamics***

On November 14, 2022, we entered into an MOU (“**JV MOU**”) with EV Dynamics and its Japan subsidiary (“**Japan Dynamics**”), which will expire on November 13, 2023 unless earlier terminated by mutual consent, to establish a joint venture in the Philippines for the purpose of carrying out a carbon-free bus leasing business to EV Dynamics’ existing clients and other new clients. Pursuant to the JV MOU, we will contribute 70% and Japan Dynamics will contribute 30%, respectively, of the total initial investments to set up and operate the joint venture. As of the date of the proxy statement/prospectus, EV Dynamics and we are working together to seek a suitable local partner in the Philippines for setting up the joint venture.

### ***B-ON***

We entered into an LOI with B-ON, an electric light commercial vehicles and fleet electrification service provider headquartered in Japan, on November 18, 2022. We aim to collaborate on a wide array of battery and energy businesses, including the sales of vehicles, battery cells, commercial car lease with offsetting carbon credits, fleet management and telematics, and charging and energy management. Possible business cooperation models include (i) B-ON will supply us their 4-wheeled and 3-wheeled EVs and will explore technological possibilities to employ our battery cell for their products; and (ii) we will offer carbon credits to B-ON and B-ON will license us the fleet management solutions and software for charging and energy management. As of the date of the proxy statement/prospectus, we are developing partnering plans with B-ON to engage in leasing of 3- and 4-wheeler EVs in Indonesia, Philippines and Thailand.

### ***TES B***

We entered into an MOU with TES B Pte Ltd (“**TES B**”), a battery recycling facility located in Singapore, on October 27, 2022. TES B intends to offer e-waste recycling service for our batteries. In addition, we aim to explore potential collaboration with respect to jointly develop repurposing and reuse program, and the integration of energy storage systems. The MOU will expire on October 26, 2023, unless earlier terminated by written agreement or by at least ten (10) business days’ prior written notice by either party to the other party.

### ***A Plastic Product Manufacturer***

We entered into an MOU with a Taiwanese company which principally engages in the manufacture and sales of plastic products, electronic products and polyester products, and 3DOM Alliance on January 1, 2022. By signing this MOU, we aim to form various arrangements including, among others, (i) the plastic product manufacturer to supply us with its battery materials for the mass production of our batteries and separators; (ii) to collaborate with third parties for the supply and development of battery materials towards the manufacturing of battery cells; (iii) to jointly develop a battery cell incorporating both parties’ technologies; (iv) to develop and commercialize business models based upon the primary and secondary usage of batteries; and (v) to collaborate in mass production of 3DOM separator. The current MOU has been extended to December 31, 2023, unless earlier terminated by mutual agreement or by thirty (30) days’ prior written notice by either party to the other party.

## **An Energy Solution Company**

We entered into an LOI with a well-known energy solution company headquartered in South Korea on September 15, 2022. By signing this LOI, we intend to engage with such company for the supply of its battery packs for our carbon neutral battery lease services. In addition, we also intend to source charging and swap stations from such company and/or engage it for the production of our battery cells and packs.

## **Assemble Point**

We entered into an MOU with 3DOM Alliance and Assemblepoint Co. Ltd. (“**Assemble Point**”), a Japanese EV maker, on December 28, 2022. By signing this MOU, we aim to jointly develop electric mini buses and batteries for such electric mini buses, and jointly provide battery-related services and carbon-free leasing services in the Philippines. The MOU will expire on December 27, 2023 and can be renewed by written agreement, unless earlier terminated (i) by the non-defaulting party upon the violation of the MOU without timely correction or (ii) by either party in the event of the commencement of insolvency proceedings against the other party.

## **Kyushu Sanko Bus**

We entered into an MOU with Kyushu Sanko Bus Co. Ltd., Sanko Bus Co. Ltd., and Kyushu Sanko Auto Service Co. Ltd. (collectively, “**Kyushu Sanko Bus**”), a bus operators in Japan, Freet Co. Ltd. and BINEX Inc. on December 20, 2022. By signing this MOU, we aim to provide carbon credits and leasing services along with carbon credits for the decarbonization of Kyushu Sanko buses operating in Kyushu region of Japan. We intend to conduct a proof of conduct on a fuel cell bus in 2025. The MOU will expire on December 19, 2023 and can be renewed by written agreement, unless earlier terminated (i) by the non-defaulting party upon the violation of the MOU without timely correction or (ii) by either party in the event of the commencement of insolvency proceedings against the other party.

## **Suppliers and Manufacturing**

Our suppliers consist primarily of (i) raw battery material suppliers and (ii) OEMs that manufacture separators, battery cells and packs, and BEVs. We are in the process of establishing business relationships with several OEM automakers and vendors of battery materials. In addition to purchasing products from our suppliers, we plan to establish collaborative partnerships with them, particular those OEMs. We also plan to work closely with suppliers to jointly develop advanced battery materials to create battery cells.

## **Sales and Marketing**

Equipped with the licensed-in technology and deep understanding of the Southeast Asia and South Asia markets, we take an insight-driven, strategic approach to our go-to-market strategy. Sales activities will be generally carried out by our full-time employees in our business development department. We are also establishing strategic partnerships with various automakers to have our batteries incorporated into their vehicles in order to capture more attention in the market.

We customize different marketing strategies for different customer types or regions, based on factors that are peculiar to their specific requirements for batteries. For example, we develop and market batteries with high viscosity electrolyte, in order to supply batteries that are highly reliable and enduring in regions where high operating temperature is an issue. For applications requiring high torque batteries, such as drones and sports cars, we adopt the X-SEPA multi-layer separators to develop high C discharge rate batteries that will not deteriorate. For the ESS market, we strategically focus on developing long-life batteries that can last up to 6,000 cycles to reduce our clients’ costs. With respect to our business of carbon abatement solutions and carbon credit sales, we secure contracts with more landowners by offering a higher percentage share of the revenue generated from carbon credit sales. In addition, we also demonstrate expertise, industry knowledge, high standards of integrity and strong relationship with the regulators.

The head of our business development team works in close consultation with our chief product officer and chief strategy officer to develop effective strategies to market our products and services to potential customers and collaborative or joint venture partners. In particular, we place a high priority on our decarbonization life cycle assessment, which we believe will help us to win more market share of the BEV and ESS market globally in the long run. Our chief operation officer is also working with the business development team to ensure that marketing and communications efforts and programs undertaken are consistent and provide meaningful assistance.

We plan to have an effective after-sales service policy in place once we begin our battery leasing business. We plan to bear the maintenance and repair costs of our batteries and our leased BEVs and ESS. To avoid disruption to our clients’ operations caused by the defects of our batteries, a spare inventory is maintained in order to replace the malfunctioning BEVs or ESS quickly.

## **Research and Development**

We do not operate or have any R&D department. Our success depends in part on the innovative and advanced technologies generated by 3DOM Alliance’s R&D department.

The primary areas of focus for 3 DOM Alliance’s R&D include, but are not limited to, X-SEPA multi-layer separators for high torque batteries, large lithium-ion battery prototypes, next-generation lithium metal anode, solid electrolyte rechargeable batteries, and phosphoric acid fuel cells (PAFC). 3DOM Alliance undertakes significant testing and validation of the battery products before supplying to us in order to meet our internal quality control standards and the demands of our clients.

## **Employees**

As of June 30, 2022, we had eight employees based primarily in Singapore, all of which were full-time employees. A majority of our employees are engaged in business development, operations, finance, and administration. None of our employees is either represented by a labor union or subject to a collective bargaining agreement. We enter into non-competition, non-solicitation and confidentiality agreements or service agreement or employment agreement that contains non-competition, non-solicitation and confidentiality clauses with our employees.

## **Environmental Matters**

We recognize that large-scale global adoption of lithium-ion batteries will require cost-effective recycling processes. Accordingly, we focus on the use of the X-SEPA battery separator, which can double the lifespan of traditional batteries, so that our battery packs can have a “second life” as refurbished batteries or for use in stationary storage application.

We also are forming a collaboration with TES B for the e-waste recycling, repurposing and reusing of our lithium-ion batteries. TES B is the first battery recycling facility in Southeast Asia which has the daily capacity to recycle up to 14 tons or the equivalent of 280,000 lithium-ion smartphone batteries.

In addition, our carbon abatement solutions business can help us reduce the carbon emission we generated in the process of our operations. We will use the carbon credit we earn during our carbon abatement projects to offset our own carbon emission. We believe our technologies, collaboration with waste recycling leaders, as well as our carbon abatement solutions business will help us contribute more to making a better environment.

## **Data Services and Protection**

### ***Data Services***

Our own-and-lease business model provides an opportunity for us to accumulate a tremendous amount of raw data. We plan to build a data infrastructure by storing, managing and analyzing our data assets. This data infrastructure is expected to produce meaningful data on battery usage and behavior for the purpose of developing increasingly efficient batteries, as well as process data for intelligent and optimized transportation. We plan to utilize our smart battery infrastructure to provide data services along with our leasing services.

### ***Data Protection***

We have established data access rights for each department and data file, and have appointed a management personnel to control such data access rights. While we have yet to establish a data protection policy, an information security committee have been set up to look into the following:

- the establishment of information management rules and guidelines, such as manner of classification of confidential information, establishment of confidential information storage locations, and documentation of intangible assets;
- establishing and strengthening information security infrastructure; and
- providing information security education for company personnel.

## **Legal Proceedings**

From time to time, we may become involved in additional legal proceedings arising in the ordinary course of its business. We are currently involved in a civil litigation in Singapore relating to an alleged breach of a share swap agreement, pursuant to which, subject to certain condition precedents by the claimant, we would engage in a share swap (the “Share Swap”) with the claimant where we will hold 24% of the claimant’s total equity interests and the claimant would hold 8% (the “Minority Interests”) of our total equity interests. In the litigation, the claimant alleges that we have substantially breached the contract by not performing the Share Swap, and demands, inter alia, that the court orders specific performance of the Share Swap. As the share swap agreement has lapsed with the claimant failing to satisfy certain condition precedents to complete the Share Swap as provided thereunder, we believe the litigation lacks merit and we have submitted an application to strike out the claim. In any case, given that the litigation only concerns the Minority Interests, our management is of the view that the outcome of the litigation would not materially affect our business. Notwithstanding the foregoing, we are currently not a party to any legal proceedings the outcome of which, if determined adversely to us, would individually or in the aggregate have a material adverse effect on our business, financial condition, and results of operations.

## **Company Information**

We were incorporated under the laws of Singapore on July 25, 2019. Our principal executive offices are located at 4 Shenton Way, #04-06 SGX Centre II, Singapore 068807, with a total area of 2,432 square feet. The lease will expire on September 14, 2024. Our phone number is (65) 6970 9643 and our contact email address is [contactus@noco-noco.com](mailto:contactus@noco-noco.com). There is no established public trading market for our ordinary shares.

## MANAGEMENT’S DISCUSSION AND ANALYSIS OF FINANCIAL CONDITION AND RESULTS OF OPERATIONS OF NOCO-NOCO

Unless the context otherwise requires, all references in this section to the “Company,” “we,” “us” or “our” refer to the business of noco-noco and its subsidiaries prior to the consummation of the Business Combination, which will be the business of the PubCo and its subsidiaries following the consummation of the Business Combination.

You should read the following discussion and analysis of our financial condition and results of operations together with the “Selected Historical Financial Data of noco-noco” and the historical unaudited consolidated financial statements as of and for the six months ended December 31, 2022 and 2021 and years ended June 30, 2022 and 2021 and the related notes included elsewhere in this proxy statement/prospectus. Some of the information contained in this discussion and analysis or set forth elsewhere in this proxy statement/prospectus, including information with respect to our plans and strategy for our business and related financing, includes forward-looking statements that involve risks and uncertainties. As a result of many factors, such as those set forth under the “Risk Factors” and “Forward-Looking Statements” sections and elsewhere in this proxy statement/prospectus, our actual results may differ materially from those anticipated in these forward-looking statements.

### Overview

We are an early-stage decarbonization solution provider in Asia, aiming to primarily engage in (i) the leasing of battery products, including batteries and BEVs to commercial transportation companies, and of ESS to renewable power plants and other power plants requiring grid stabilization and backup power; and (ii) carbon abatement solutions for landowners and carbon credit sales.

We are a pre-commercialization stage company with no revenue to date. We have incurred net loss of \$1.2 million and \$0.6 million, respectively, for the six months ended December 31, 2022 and 2021, and have incurred net loss of \$1.1 million and \$0.7 million, respectively, for the years ended June 30, 2022 and 2021. We have an accumulated deficit of \$3.5 million as of December 31, 2022, and an accumulated deficit of \$2.4 million as of June 30, 2022.

### Key Factors Affecting Our Business

As a pre-commercialization stage company, we believe that our performance and future success depend on several factors that present significant opportunities for us but also pose significant risks and challenges, including those discussed below and in the section titled “Risk Factors” appearing elsewhere in this proxy statement/prospectus.

#### ***Continued Development and Upgrade of Our Battery Products***

We license in a series of state-of-the-art patents and know-how technologies from 3DOM Alliance, our majority shareholder, with respect to, among others, battery cascade use, battery management system, battery cell and pack model, and battery units. For details of our licensing-in arrangement with 3DOM Alliance, see “*noco-noco’s Business—Relationship with 3DOM Alliance.*” These licensed-in technologies enable us to produce batteries that we believe, as compared to conventional batteries, are designed to have a longer lifespan and higher reliability, and be more resistant to high operating temperature and thermal runaways. Therefore, our ability to produce state-of-the-art battery products and achieve profitability in our leasing services depends, in part, on the continued innovation of the technologies licensed-in from 3DOM Alliance.

#### ***Partnering with Industry-Leading Automakers and Manufacturers***

We have entered into several MOUs with our strategic partners, including well-known automakers and battery manufacturers, for potential business collaborations and formation of strategic joint ventures. See “*noco-noco’s Business—Partnerships.*” We believe that our battery products will experience swift market adoption due to our strategic partnerships with these automakers and manufacturers. We plan to collaborate with other automakers and OEMs to expedite such adoption and increase market acceptance of our battery products over time.

### ***Ability to procure new contracts with landowners***

The key factor driving the demand for carbon credits is the global push towards decarbonization, driven by governmental and supra national bodies, such as the United Nations. As more and more nations start to adopt or even accelerate the setting of standards for compliance towards zero carbon emissions, the demand for carbon credits is anticipated to surge. Carbon credit prices have been in an uptrend since 2007 and, aside from minor short-term fluctuations, are likely to continue the long-term uptrend. This will mean higher earnings from our carbon credit sales. Therefore, our ability to procure and sign new contracts with landowners to increase credits generations is highly dependent on our reputation and expertise in this industry. As such, our business is subject to adverse events which may cause damage, whether real or perceived, to our reputation. For more information, see “*Risk Factors—Risks Related to noco-noco’s Business and Industry.*”

### ***Competition***

The battery and BEV market is fast-growing, competitive and driven by the innovation of both large companies and emerging entrants like us. We acknowledge that the existing market players and other emerging entrants may have greater resources to invest in advancing their technologies, access to more potential customers, or strategic relationships with OEMs (or other third parties) that may give them a competitive edge. We further acknowledge that these disparities, where they exist, have the potential to harm our business, results of operations or financial condition.

### ***Capital Needs***

We have incurred net loss and negative cash flows from operations for the six months ended December 31, 2022 and 2021, and for the years ended June 30, 2022 and 2021, respectively. Assuming we experience no significant delays in the commercialization of our business, we believe that our cash resources are sufficient to fund our marketing activities and manufacturing of battery products through OEMs. For more information, see “*Liquidity and Capital Resources.*”

### ***Government Regulatory and Compliance***

There are government regulations pertaining to battery safety, transportation of batteries, use of batteries in vehicles, product liabilities and disposal of hazardous materials. We will ultimately have to comply with these regulations to lease our battery products. In addition, changes in national or global regulations may affect the demand for credits or our ability to generate credits. Hence, we are constantly keeping abreast of current or potential changes in regulations, and where possible, engage with the regulators in order to understand or anticipate potential headwinds that may affect our business. See “*Risk Factors—Risks Related to noco-noco’s Business and Industry*” for the risks that may affect our business, and “*Government Regulations*” for details of the regulations that are applicable to our business operations.

### ***Basis of Presentation***

Our financial statements have been prepared in conformity with U.S. GAAP in U.S. dollars. For more information about our basis of presentation, refer to Note 3 to our accompanying unaudited consolidated financial statements as of and for the six months ended December 31, 2022 and 2021 and audited financial statements as of and for the years ended June 30, 2022 and 2021.

## Significant Accounting Policies and Estimates

### Cash and Cash Equivalents

Cash and cash equivalents consist of cash on hand and demand deposit with banks, which are unrestricted as to withdrawal and use, and which have original maturities of three months or less when purchased.

### Inventories

Inventories, consisting of finished goods, are primarily accounted for using the first-in-first-out method of accounting. Inventories are measured at the lower of cost and net realizable value. Cost consists of the price purchase stock and we estimate the net realizable value of inventories based on an assessment of expected sales prices. Demand levels and pricing competition could change from time to time. If such factors result in an adverse effect on our products, we might be required to reduce the value of its inventories.

### Deposit, Upfront Payment and Other Receivables

Security deposits paid for office lease are accounted for as deposit. Amounts paid in advance for future expenses are accounted for as prepaid expenses. Goods and service tax refunds and collection of proceed from sales of batteries to business partner are accounted for as other receivables.

### Property and equipment

Property and equipment are stated at cost, less accumulated depreciation. Expenditures for additions, major renewals and betterments are capitalized and expenditures for maintenance and repairs are charged to expense as incurred.

Depreciation is computed using the straight-line method over the estimated useful lives of the related capitalized assets. The estimated useful lives are as follows:

	<u>Useful lives</u>
Office equipment	5 years

### Other Current Liabilities

Other current liabilities are liabilities for goods and services provided to us prior to the end of the financial year which are unpaid. They are classified as current liabilities if payment is due within one year or less. If not, they are presented as non-current liabilities.

### Leases

We have entered into operating lease agreements primarily for office. We determine if an arrangement is a lease at inception. For all classes of underlying assets, we elect not to recognize right of use assets or lease liabilities when a lease has a lease term of 12 months or less at the commencement date and does not include an option to purchase the underlying asset that we are reasonably certain to exercise. Operating lease assets and liabilities are included on our balance sheet as of December 31, 2022 and 2021.

Operating lease assets and liabilities are recognized at the present value of the future lease payments at the lease commencement date. The interest rate used to determine the present value of the future lease payments is our incremental borrowing rate, because the interest rate implicit in most of our leases is not readily determinable. Our incremental borrowing rate is estimated to approximate the interest rate on a collateralized basis with similar terms and payments, and in economic environments where the leased asset is located. Operating lease assets also include any prepaid lease payments and lease incentives. Our lease terms include periods under options to extend or terminate the lease when it is reasonably certain that we will exercise that option. We generally use the base, non-cancellable, lease term when determining the lease assets and liabilities. Operating lease expense is recognized on a straight-line basis over the lease term.

### Recent Accounting Pronouncements

In June 2016, the Financial Accounting Standards Board (the "FASB") issued Accounting Standard Update No. 2016-13, Financial Instruments – Credit Losses (Topic 326), Measurement of Credit Losses on Financial Instruments. This standard requires a financial asset (or group of financial assets) measured at amortized cost basis to be presented at the net amount expected to be collected. The allowance for credit losses is a valuation account that is deducted from the amortized cost basis of the financial asset(s) to present the net carrying value at the amount expected to be collected on the financial asset. This standard became effective to us on January 1, 2023. We are currently evaluating the impact the adoption of this ASU will have on our consolidated financial statements.

In December 2019, the FASB issued Accounting Standard Update No. 2019-12, Income Taxes (Topic 740): Simplifying the Accounting for Income Taxes (ASU 2019-12), which simplifies the accounting for income taxes. This guidance became effective for entities for the fiscal years, and interim periods within those fiscal years, beginning after December 15, 2020 on a prospective basis, with early adoption permitted. We adopted the new standard effective January 1, 2021 and the adoption of this guidance did not have a material impact on our financial statements.

We do not expect any other recently issued accounting standards to have a material impact on our financial position, results of operations or cash flows when they become effective.



## **Components of Results of Operations**

We are an early-stage growth company in the pre-commercialization stage of development. We have not generated any revenue from sales to customers, and our historical results may not be indicative of our future results for reasons that may be difficult to anticipate. Our ability in the future to generate revenue sufficient to achieve profitability will depend largely on the successful development of our battery products as well as the commercialization of our own-and-lease business model and our carbon abatement solution business. Accordingly, the drivers of our future financial results, as well as the components of such results, may not be comparable to our historical results of operations.

### ***Operating expenses***

Our operating expenses consist of research and development (“R&D”) cost, and selling, general and administrative expenses. Our R&D expenses are primarily attributable to our engagement of a system integrator to carry out R&D work for residential energy storage systems. Our selling, general and administrative expenses consist primarily of directors’ remuneration, payroll and related cost, expenses incurred for depreciation of office equipment, and costs incurred for outside contractor and professional service fees, audit and compliance expenses, legal, accounting and other advisory services. For the six months ended December 31, 2022 and 2021, we incurred total operating expenses of \$1.2 million and \$0.6 million, respectively. For the years ended June 30, 2022 and 2021, we incurred total operating expenses of \$1.1 million and \$0.7 million, respectively.

We are rapidly expanding our personnel headcount, in anticipation of planning for and supporting our growth and operating as a public company. Accordingly, we expect our selling, general and administrative expenses to increase significantly in the near term and for the foreseeable future. Upon commencement of commercial operations, we also expect to incur customer and sales support and advertising expenses.

### ***Other income/(expense)***

Other income/(expense) comprises of (i) other income, including a one-off sale of batteries to a business partner and COVID-19 government grant, (ii) other expense, including costs incurred from the one-off sale of batteries, and (iii) foreign exchange gain. For the six months ended December 31, 2022 and 2021, we generated total other income of \$35,046 and \$8,365, respectively. For the years ended June 30, 2022 and 2021, we generated total other income of \$11,828 and \$50,435, respectively.

## Results of Operations

The following table sets forth a summary of our results of operations for the periods indicated.

	For the Six Months Ended December 31,		For the Years Ended June 30,	
	2022	2021	2022	2021
	Unaudited	Unaudited		
<b>Operating expenses:</b>				
	-	-	137,412	4,948
Selling, general and administrative expenses	1,189,696	611,193	951,239	717,298
<b>Total operating expenses</b>	<b>1,189,696</b>	<b>611,193</b>	<b>1,088,651</b>	<b>722,246</b>
<b>Loss from operations</b>	<b>(1,189,696)</b>	<b>(611,193)</b>	<b>(1,088,651)</b>	<b>(722,246)</b>
<b>Other income/(expense):</b>				
Other income	26,987	8,365	11,792	65,434
Other expense	(257)	-	-	(14,999)
Foreign exchange gain	8,315	-	36	-
<b>Total other income</b>	<b>35,046</b>	<b>8,365</b>	<b>11,828</b>	<b>50,435</b>
<b>Net loss</b>	<b>\$ (1,154,650)</b>	<b>\$ (602,828)</b>	<b>\$ (1,076,823)</b>	<b>\$ (671,811)</b>

### Comparison of Six Months Ended December 31, 2022 and 2021

**Operating expenses.** Total operating expenses increased by 94.7% to \$1.2 million for the six months ended December 31, 2022 from \$0.6 million for the six months ended December 31, 2021. The increase was primarily due to (i) an increase in selling, general and administrative expenses of \$578,503, which was primarily attributable to an increase in payroll and related cost associated with the hiring of new employees.

**Other income/(expense).** Total other income increased by 319% to \$35,046 for the six months ended December 31, 2022 from \$8,365 for the six months ended December 31, 2021. Such increase was primarily because (i) we received more government working labour relief of \$26,987, and (ii) exchanges gains of \$8,315.

### Comparison of Years Ended June 30, 2022 and 2021

**Operating expenses.** Total operating expenses increased by 50.7% to \$1.1 million for the year ended June 30, 2022 from \$0.7 million for the year ended June 30, 2021. The increase was primarily due to (i) an increase in selling, general and administrative expenses of \$233,941, which was primarily attributable to an increase in payroll and related cost associated with the hiring of new employees and partially offset by a decrease in professional fees and a decrease in directors' remuneration, and (ii) an increase in R&D cost of \$132,464 which was due to the progressive development of a prototype of a residential energy storage system.

**Other income/(expense).** Total other income decreased by 76.5% to \$11,828 for the year ended June 30, 2022 from \$50,435 for the year ended June 30, 2021. Such decrease was primarily because (i) we generated other income from a one-off sales of batteries to a business partner of \$17,046, and (ii) we received a COVID-19 related rental waiver of \$33,249, both of which were recognized for the year ended June 30, 2021 but not for the year ended June 30, 2022, and partially offset by (iii) other expense of \$14,999 which consisted of the costs incurred from the one-off sale of batteries.

**Net loss.** As a result of the foregoing, our net loss increased by 91.5% to \$1.1 million for the six months ended December 31, 2022 from \$0.6 million for the six months ended December 31, 2021. Our net loss increased by 60.3% to \$1.1 million for the year ended June 30, 2022 from \$0.7 million for the year ended June 30, 2021.

## **Liquidity and Capital Resources**

Historically, our principal sources of liquidity have been financing transactions with investors and loans from our majority shareholder that have provided us with the necessary funds to support our business activities. As of December 31, 2022, we had raised approximately \$1.5 million of funding through the issuance of ordinary shares. On August 1, 2020, we issued a promissory note with 3DOM Alliance (the “**Note**”). The Note provides for borrowings upon our request, on one or more occasions, up to an aggregate of principal amount of S\$8.0 million (\$5.8 million). No interest shall accrue to any loans under the Note. As of [May 15], 2023, we had drawn down an aggregate amount of S\$[6.41] million (\$[4.82] million). See “*Certain Relationships and Related Person Transactions—noco-noco and PubCo Relationships and Related Party Transactions—Promissory Note.*”

On November 22, 2022, we entered into an exclusive, irrevocable license-in agreement with 3DOM Alliance, pursuant to which we are obligated to pay a one-off, refundable upfront payment of \$30 million licensing fee to 3DOM Alliance. In addition, we shall pay quarterly royalties equal to three percent (3%) of the gross profit generated using each of 3DOM IP Rights granted to us, including its proprietary and licensed-in patents and other intellectual property, as well as confidential yet critical know-how and other information. Such upfront payment shall be credited against any royalties under the agreement such that the amount of the upfront payment shall be deducted from the royalties when due and payable. In the event that the upfront payment has any remaining amount after the last deduction from the royalties at the end of a five-year period from the last instalment of the upfront payment, the remaining unutilized amount shall be refunded to us at our request. Pursuant to a supplemental agreement to the license-in agreement dated May 10, 2023 (the “*Supplemental Agreement*”), the upfront payment shall be payable over a series of instalments after the consummation of the Business Combination, in such amounts and pursuant to such repayment schedule as may be agreed between 3DOM Alliance and us. Both parties shall negotiate the installment plan in good faith, taking into consideration our working capital needs as well as our liquidity and available capital resources after the consummation of the Business Combination. As a result, we do not expect that the \$30 million upfront payment will have a material impact on our liquidity and capital resources before or after the consummation of the Business Combination. As of the date of the proxy/registration statement, we had not paid any upfront payments to 3DOM Alliance yet. See “*noco-noco’s Business—Relationship with 3DOM Alliance*” and “*Certain Relationships and Related Person Transactions—noco-noco and Pubco Relationships and Related Party Transactions—Licence-in Agreement.*”

As of December 31, 2022, we had cash and cash equivalents of \$21,449. As of June 30, 2022, we had cash and cash equivalents of \$81,626. Our cash and cash equivalents are primarily denominated in Singapore dollars as well as in local currencies of our Priority Markets. We have yet to generate any revenue from our business operations, and we have not achieved profitable operations or positive cash flows from our operations since inception. Our accumulated deficit aggregated \$3.5 million as of December 31, 2022 and we expect to incur substantial losses in future periods. As an early-stage growth company in the pre-commercialization stage of development, the net loss we have incurred since inception are consistent with our strategy and budget.

We plan to finance our operations with a combination of proceeds from the Business Combination, capital from investors and shareholders, and if required in the future, loans from financial institutions, as well as anticipated future revenue from our service offerings. Our ability to successfully develop our products, commence commercial operations and expand our business will depend on many factors, including our working capital needs, the availability of equity and/or debt financing and, over time, our ability to generate positive cash flows from operations. We believe that our cash on hand following the Business Combination will be sufficient to meet our working capital and capital expenditure requirements for a period of at least 12 months from the date of this filing.

As a result of the capital-intensive nature of our business, we expect to sustain substantial operating expenses, without generating sufficient revenues, to cover expenditures for a number of years. Over time, we expect that we will need to raise additional funds through a variety of possible methods, including, but not limited to, entry into joint ventures or other strategic arrangements, the issuance of equity, equity-related or debt securities or through obtaining credit from financial institutions. These funds are expected to finance our principal sources of liquidity and ongoing operating expenses. If we were to require additional funding or otherwise determined it was beneficial to seek additional sources of financing or enter into other arrangements as described above, we believe that our debt-free balance sheet would enable us to access financing on reasonable terms. However, there can be no assurance that such additional capital would be available on attractive terms, if at all, when needed, which could be dilutive to stockholders. We may be forced to decrease our level of investment in product development or scale back our operations. Furthermore, the cost of debt could be higher than anticipated. There can also be no assurance that positive cash flow from operations can be achieved or sustained. See “*Risk Factors—Risks Related to noco-noco’s Business and Industry—We may need to raise additional funds and these funds may not be available to us when we need them. If we cannot raise additional funds when we need them, our business, prospects, financial condition and operating results could be negatively affected.*”

### Working Capital/(Deficit)

	As of December 31,		Changes	%
	2022	2021		
Current assets	\$ 517,075	\$ 219,398	\$ 297,677	135.7%
Current liabilities	1,877,603	692,027	1,185,576	171.3%
Working capital deficit	<u>\$ (1,360,528)</u>	<u>\$ (472,629)</u>	<u>\$ (887,899)</u>	<u>187.9%</u>

Our cash and cash equivalents amounted \$214,449 and \$114,922 as of December 31, 2022 and 2021, respectively.

	As of June 30,		Changes	%
	2022	2021		
Current assets	\$ 183,889	\$ 278,334	\$ (94,445)	(33.9)%
Current liabilities	1,024,244	1,714,765	(690,521)	(40.3)%
Working capital deficit	<u>\$ (840,355)</u>	<u>\$ (1,436,431)</u>	<u>\$ 596,075</u>	<u>(41.5)%</u>

Our cash and cash equivalents amounted \$81,626 and \$31,690 as of June 30, 2022 and 2021, respectively.

As of December 31, 2022, we had total liabilities of \$2.0 million, consisting of accruals and other payable of \$27,266, amount due to shareholders of \$1.7 million, current portion of operating lease liabilities of \$169,334 and the non-current portion of operating lease liabilities of \$124,918. As of June 30, 2022, we had total liabilities of \$1.0 million, consisting of accruals and other payable of \$13,227, amount due to shareholders of \$1.0 million and current portion of operating lease liabilities of \$36,385.

As of December 31, 2021, we had total liabilities of \$0.7 million, which included accruals and other payable of \$127,839, amount due to shareholders \$0.4 million, and current portion operating lease liabilities of \$0.1 million. As of June 30, 2021, we had total liabilities of \$1.7 million, which included accruals and other payable of \$9,856, amount due to shareholders \$1.5 million, current portion operating lease liabilities of \$0.2 million and the non-current portion of operating lease liabilities of \$36,779.

As of December 31, 2022, we had a working capital deficiency of \$1.4 million compared with a working capital deficiency of \$0.5 million as of December 31, 2021. The increase in the working capital deficiency was primarily due to cash advances of \$1.5 million. As of June 30, 2022, we had a working capital deficiency of \$0.8 million compared with a working capital deficiency of \$1.4 million as of June 30, 2021. The decrease in the working capital deficiency was primarily due to shareholder conversion of debt of \$1.5 million into ordinary shares on October 22, 2021.

### Cash Flows

The following table summarizes our cash flow data for the six months ended December 31, 2022 and 2021.

	For the Six Months Ended December 31,		Changes	%
	2022	2021		
Cash used in operating activities	\$ (1,341,533)	\$ (284,800)	(1,056,733)	371.0%
Cash used in investing activities	(5,735)	(1,229)	(4,506)	366.7%
Cash generated from financing activities	1,496,657	398,222	1,098,435	275.8%
Increase/(decrease) in cash and cash equivalents	149,389	112,193	37,196	33.2%

	Year Ended June 30,		Changes	%
	2022	2021		
Cash used in operating activities	\$ (805,177)	\$ (723,307)	(81,870)	11.3%
Cash used in investing activities	(3,888)	-	(3,888)	N/A
Cash generated from financing activities	873,066	689,781	183,285	26.6%
Increase/(decrease) in cash and cash equivalents	64,001	(33,526)	97,528	290.1%

### ***Cash used in operating activities***

Net cash used in operating activities for the six months ended December 31, 2022 was \$1.3 million, while our net loss for the same year was \$1.1 million. The difference was primarily due to (i) adjustments for non-cash items including depreciation expense of \$2,222, disposal of asset of \$257, and changes in working capital including (ii) an increase in deposits & upfront payments of \$200,363, partially offset by (iii) an increase in operating lease liabilities of \$3,037, and (iv) an increase in accruals and other payables of \$14,039. Net cash used in operating activities for the year ended June 30, 2022 was \$0.8 million, while our net loss for the same year was \$1.1 million. The difference was primarily due to (i) adjustments for non-cash items including depreciation expense of \$3,447, and changes in working capital including (ii) a decrease in inventory of \$163,259, (iii) an increase in accruals and other payables of \$121,253, and (iv) an increase in operating lease liabilities of \$2,565, partially offset by (v) an increase in deposit, upfront payments and other receivables of \$18,878.

Net cash used in operating activities for the six months ended December 31, 2021 was \$0.3 million, while our net loss for the same year was \$0.6 million. The difference was primarily due to changes in working capital including (i) an increase in inventory of \$163,259, (ii) an increase in accruals and other payables of \$173,137, and (iii) an increase in operating lease liabilities of \$1,038, partially offset by (iv) an increase in deposit and upfront payments of \$163,259, and (v) adjustments for non-cash items including depreciation expense of \$1,685. Net cash used in operating activities for the year ended June 30, 2021 was \$0.72 million, while our net loss for the same year was \$0.67 million. The difference was primarily due to changes in working capital including (i) an increase in inventory of \$163,259, (ii) an increase in deposit, upfront payments and other receivables of \$22,957, and (iii) a decrease in operating lease liabilities of \$10,163, partially offset by (iv) an increase in accruals and other payables of \$141,725, and (v) adjustments for non-cash items including depreciation expense of \$3,158.

### ***Cash used in investing activities***

Net cash used in investing activities for the six months ended December 31, 2022 and 2021 was \$5,735 and \$1,229, primarily comprising of purchase of computers, respectively. cash used in investing activities for the year ended June 30, 2022 was \$3,888, primarily comprising of purchase of computers.

We did not have any investing activities for the year ended June 30, 2021.

### ***Cash generated from financing activities***

Net cash generated from financing activities primarily consisted of advances from 3DOM Alliance, amounting to \$1.5 million and \$0.4 million for the six months ended December 31, 2022 and 2021, respectively. Net cash generated from financing activities primarily consisted of advances from 3DOM Alliance, amounting to \$0.9 million and \$0.7 million for the years ended June 30, 2022 and 2021, respectively.

### ***Capital Expenditures***

Our capital expenditures amounted to \$5,735 and \$1,229 for the six months ended December 31, 2022 and 2021, respectively. Our capital expenditures amounted to \$3,888 for the year ended June 30, 2022. These capital expenditures primarily related to the purchase of computers. These capital expenditures primarily related to the purchase of computers. We expect to continue to make capital expenditures to meet the expected growth in scale of our business and expect that cash generated from our cash and cash equivalents following the Business Combination and cash from operating activities and financing activities may be used to meet our capital expenditure needs in the foreseeable future.

## **Off-Balance Sheet Commitments and Arrangements**

As of December 31, 2022, we did not have any off-balance sheet arrangements, as defined in the rules and regulations of the SEC, that have or are reasonably likely to have a current or future effect on our financial condition, changes in our financial condition, revenue, or expenses, results of operations, liquidity, capital expenditures, or capital resources that are material to investors.

## **Quantitative and Qualitative Disclosures About Market Risks**

We are exposed to market risks in the ordinary course of our business. These risks primarily include credit risk and foreign currency risk.

### ***Credit Risk***

Credit risk is the potential financial loss to us resulting from the failure of a customer or a counterparty to settle our financial and contractual obligations, as and when they fall due. As we do not hold any collateral, the maximum exposure to credit risk is the carrying amounts of trade and other receivables (exclude upfront payments) and cash and bank deposits presented on the consolidated balance sheets. We have no other financial assets which carry significant exposure to credit risk.

### ***Foreign Currency Risk***

We operate in several countries and regions, which exposes us to the effects of fluctuations in currency exchange rates as we report our financials and key operational metrics in US dollars. We earn revenue denominated in, and generally incur expenses for employee compensation and other operating expenses in, local currencies. Fluctuations in the exchange rates among the various currencies that we use could cause fluctuations in our operational and financial results.

## **Internal Control Over Financial Reporting**

Prior to the closing of the Business Combination, we have been and will be a private company with limited numbers of accounting personnel and other resources with which to address our internal controls and procedures. In connection with the audit of our consolidated financial statements for the years ended June 30, 2022 and 2021, we and our auditors, an independent registered public accounting firm, identified one material weakness in our internal control over financial reporting. As defined in the standards established by the PCAOB, a “material weakness” is a deficiency, or combination of deficiencies, in internal control over financial reporting, such that there is a reasonable possibility that a material misstatement of the annual or interim financial statements will not be prevented or detected on a timely basis. A “significant deficiency” is a deficiency, or a combination of deficiencies, in internal control over financial reporting, that is less severe than a material weakness yet important enough to merit attention by those responsible for oversight of the company’s financial reporting.

## MANAGEMENT OF PUBCO FOLLOWING THE BUSINESS COMBINATION

Unless the context otherwise requires, all references in this subsection to the “Company,” “we,” “us” or “our” refer to PubCo and its subsidiaries following the consummation of the Business Combination.

### Director Nominees and Executive Officers

The following table sets forth certain information relating to the executive officers and directors of PubCo immediately after the consummation of the Business Combination.

<b>Name</b>	<b>Age</b>	<b>Position/Title</b>
Mr. Masataka Matsumura	42	Chief Executive Officer and Director Nominee
Ms. Mari Matsushita	47	Chief Product Officer and Director Nominee
Mr. Yuta Akakuma	38	Head of Business Development and Director Nominee
Mr. Yoshinori Kurahashi	39	Chief Financial Officer
Mr. Tatsuo Mori	58	Head of Product Management
Mr. Timothy Lai Wah Teo	70	Independent Director Nominee
Mr. Heizo Takenaka	72	Independent Director Nominee
Mr. Jean-Francois Raymond Roger Minier	52	Independent Director Nominee

The business address of each director nominee and executive officer of PubCo will be 4 Shenton Way, #04-06 SGX Centre II, Singapore 068807.

**Masataka Matsumura** will serve as a Director on our board of directors as well as our Chief Executive Officer. He has served as noco-noco’s chief executive officer, since November 2022, and a director, since October 2022. Mr. Matsumura currently also serves as the representative director and the chief executive officer of 3DOM Alliance since September 2018 where he has served as a director since November 2016. He is also a director of Tesnology Inc. since April 2020 and was a director of BINEX Inc. from May 2021 to January 2023, which both of them are the fellow subsidiaries of noco-noco. In addition, he is also serving as the representative director on the board of Quintuple Air Inc., Social Mobility, Inc. and FOREST PINE DESIGN LAB Inc., since November 2019, December 2018 and November 2012, respectively, and has been serving as a non-executive director of Ellebeau Inc. since June 2014. From December 2013 to February 2019, Mr. Matsumura served as a director of Future Science Research Inc., which is one of the principal shareholders of noco-noco. Prior to Future Science Research Inc., he was the creative director of Fujiwara Design Studio S.R.L., and also the representative director and the president of Steadfast Inc. from April 2005 to June 2012. Mr. Matsumura received his bachelor of fine arts degree in fashion design and marketing from American InterContinental University London.

**Mari Matsushita** will serve as a Director on our board of directors. She has also been serving as the chief product officer of noco-noco since October 2022 and the general manager of the platform development team of 3DOM Alliance since April 2021. Prior to joining us, Ms. Matsushita previously worked as a product manager at Fourth Valley Concierge Corporation from March 2017 to February 2021 and at Tsuburaya Fields Holdings Inc. from October 2012 to March 2017. From January 2004 to September 2012, Ms. Matsushita was a senior web producer at IMJ Corporation, responsible for digital marketing with data analytics and web integration. She worked at DeeCorp Limited as a market researcher from August 2003 to December 2003. Prior to DeeCorp, Ms. Matsushita worked as a sales and marketing manager at JEPICO Corporation from April 1998 to July 2003. Ms. Matsushita received her bachelor of arts in international legal study from Sophia University in Japan in 1998.

**Yuta Akakuma** will serve as a Director on our board of directors. Mr. Akakuma has been the head of business development of noco-noco since November 2022, where he was previously working as a business development manager from May 2022 to October 2022. In addition, Mr. Akakuma has been serving as the managing director and the chief executive officer of 3DOM (Asia) Co., Ltd., a fellow subsidiary of noco-noco, since November 2022. Prior to this, he worked as the general manager of sales and marketing department and joint venture department at Summit Auto Seats Industry from April 2019 to April 2022, during which he also served as director for several subsidiaries of Summit Auto Seats Industry. He also worked at Darwin Summit Corporation Company Limited, as general manager from April 2019 to April 2022, and simultaneously served as the deputy chief executive officer at Faurecia and Summit Interior Systems Thailand Co., Ltd., the chief executive officer at Summit Hirotani Sugihara Co., Ltd. and a director at Summit & Autoneum (Thailand) Co., Ltd., from June 2020 to April 2022. Prior to that, Mr. Akakuma was the deputy managing director at Soltec Thai Co., Ltd from May 2018 to April 2019. Mr. Akakuma founded Sakura Kaigo (Thailand) Co., Ltd. and served as its managing director from November 2013 to April 2018. Before that, he founded Imm & Co., Ltd. and served as managing director from May 2010 to April 2018. Prior to the founding of his own companies, he worked as the Thailand representative office manager at Agilis Inc. from October 2008 to May 2010. Mr. Akakuma received his bachelor of arts degree in environmental and information studies from Keio University in Japan in 2008.

**Yoshinori Kurahashi** will serve as our Chief Financial Officer. He has served as noco-noco's chief financial officer since December 2022 and leads various corporate matters, including financial operations, corporate accounting and reporting, treasury, financial planning and analysis, investor relations, tax, and procurement. Mr. Kurahashi has been serving as the general manager of the finance department of 3DOM Alliance since October 2022 where he started as a finance manager in April 2022. Prior to that, he worked on accounting audit and internal control audit at Ernst & Young for 16 years from April 2006 to March 2022. Mr. Kurahashi received a bachelor of commerce degree from Waseda University, Faculty of Commerce, in Japan in 2006 and is a certified public accountant registered in Japan.

**Tatsuo Mori** will serve as noco-noco's head of product management. Mr. Mori has been serving as the manager of the Skinkoyasu office and the product division manager of 3DOM Alliance since March 2021. He has 30 years' experience in the battery business. Mr. Mori previously worked at Panasonic Holdings Corporation ("Panasonic") for more than 28 years from September 1990 to July 2020, serving as product development engineer and plant manager, responsible for overseeing the manufacturing floor and management of the battery manufacturing plant, and then as the president of several Panasonic's subsidiaries. Prior to Panasonic, he worked at Nichicon Corporation as product development engineer from April 1987 to August 1990. Mr. Mori obtained his bachelor of science in engineering from Chuo University Faculty of Science and Engineering in Japan in 1987.

**Timothy Lai Wah Teo** will serve as an Independent Director on our board of directors. He has served as an independent director of noco-noco since August 2021 and is currently serving as a director on the board of Dr Andrew Ng Global Missions Fund, School of the Arts, Singapore (SOTA) and the JurongHealth Fund (JHF). He is also currently an independent director of Pilgrim Partners (Asia) Pte. Ltd. since February 2010 and a director of Sparrow Asset Management Pte. Ltd. since August 2008. From November 2008 to October 2021, Mr. Teo served as an independent non-executive director and the chairman of the audit and risk management committee of the Singapore Exchange listed GuocoLand Limited. From April 1998 to March 2007, Mr. Teo was the director of the Government of Singapore Investment Corporation, in charge of foreign exchange, money market, gold and commodities management. Prior to this, he served as a director of Nuri Holdings Singapore from October 1994 to April 1998. Mr. Teo also worked at JP Morgan for 20 years in various overseas locations at senior management level in global markets department from May 1975 to June 1993. Mr. Teo completed his master of business administrative at Macquarie University in Sydney, Australia in July 1996.

**Heizo Takenaka** will serve as an Independent Director on our board of directors. He has served as an independent director of 3DOM Alliance since June 2022. Mr. Takenaka is currently a professor emeritus at Keio University in Japan where he started as an associate professor in April 1990. He is concurrently serving as a visiting associate professor at Harvard University since January 1989 where he started as a visiting scholar in January 1981. In addition, he is also holding positions including research advisor to the Japan Center for Economic Research since December 2010 where he started as a special advisor in December 2006, chairman of the board of academyhills since December 2006, independent director of SBI Holdings, Inc. since June 2016, and member of the board of trustees of the World Economic Forum since June 2007. He was elected to the House of Councilors in July 2004, then resigned from the House of Councilors in September 2006. In April 2001, he was appointed Minister of State for Economic and Fiscal Policy in the Koizumi Cabinet, followed by appointments as Minister of State for Financial Services in September 2002, Minister of State for Privatization of Postal Services in September 2004, and Minister of Internal Affairs and Communications from October 2005 to September 2006. Prior to that, Mr. Takenaka worked at the Japan Development Bank since March 1973 to January 1981. He received a bachelor of arts in economics from Hitotsubashi University in Japan in April 1973 and a Ph.D. in economics from Osaka University in April 1994.



**Jean-Francois Raymond Roger Minier** will serve as an Independent Director on our board of directors. Mr. Minier is currently serving as the Asia Pacific regional director of Audere International since April 2022, the joint representative director and co-chief executive officer of Les Rois Mages Japan Co., Ltd. since November 2021, an independent director of DKK Denki Kogyo Co., Ltd. since June 2021, an independent auditor of Amuseum Parks Co., Ltd. since April 2020, a trustee of Ueno Gakuen Educational Foundation and a representative director of ABC Properties Co., Ltd. since March 2017. He previously worked as a managing director and then a senior advisor at Kroll, LLC from April 2020 to March 2022, a corporate project director at Rusal from November 2016 to March 2020, a non-executive director and the head of corporate development in Northeast Asia of First Names Group from November 2016 to October 2017. Mr. Minier had also served as the managing director and Asia head of fund services at Moore Group Limited from November 2013 to October 2016, an advisor to the chairman for international relations at Kyoto Prefectural Union of Agricultural Cooperatives from April 2013 to August 2016, an advisor to the chief executive officer (Japan and Korea) at Buhler Group from November 2013 to December 2015. Prior to that, he worked as an Asia-Pacific advisor at Avis Partners from September 2009 to October 2013, the chief executive officer of Asia Pacific region and Tokyo branch manager at Dresdner Kleinwort from August 2006 to September 2009, managing director, Tokyo branch manager and head of capital markets in Asia Pacific at Dresdner Kleinwort Wasserstein from August 2001 to July 2006, managing director of global equities at Dresdner Kleinwort Benson from March 1998 to July 2001, head of OTC equity derivatives trading at Natwest Securities from February 1997 to February 1998. Mr. Minier also worked as a vice president and an equity derivatives trader at Morgan Stanley Japan from April 1995 to January 1997, an equity derivatives trader and structurer at Bankers Trust from December 1993 to March 1995, and an equity derivatives trader at Indosuez W.I. Carr from September 1992 to November 1993. Mr. Minier received his master of science in financial mathematics from Ecole Polytechnique in Paris, France in 1992 and completed the Allianz SE executive leadership program at IMD Business School in Shanghai, China in November 2003.

## **Board of Directors**

Our board of directors will initially consist of [six] directors immediately after the consummation of the Business Combination. Of these initial [six] directors, [three] will be independent. As a controlled company and foreign private issuer, we have elected to not have a majority of our board consist of independent directors. The Amended PubCo Charter provide that the minimum number of directors shall be three, which may be increased or reduced by ordinary resolution, and the maximum number of directors shall be unlimited unless fixed by ordinary resolution. Except as provided in the Amended PubCo Charter, a director may vote in respect of any contract or transaction in which he/she is interested provided that the nature of the interest of any director in any such contract or transaction is disclosed at or prior to its consideration and any vote thereon, and such director may be counted in the quorum at any meeting of directors at which any such contract or transaction is considered. A director who is interested in a contract or proposed contract with us must declare the nature of his interest at a meeting of the directors. None of our non-employee director has a service contract with us that provides for benefits upon termination of service.

## **Duties of Directors**

Under the laws of the Cayman Islands, our directors owe certain fiduciary duties to us, including a duty of loyalty, a duty to act honestly, and a duty to act in good faith in what they consider to be in our best interests. Our directors must also exercise their powers only for a proper purpose. Our directors also have a duty to exercise the skills they actually possess and such care and diligence that a reasonably prudent person would exercise in comparable circumstances.

In fulfilling their duty of care to us, our directors must ensure compliance with our memorandum and articles of association as may be amended from time to time. Our company has a right to seek damages against any director who breaches a duty owed to us.

The functions and powers of our board of directors include, among others:

- convening shareholders' annual general meetings and reporting its work to shareholders at such meetings;
- declaring dividends and distributions;
- appointing officers and determining the term of office of officers; and
- exercising the borrowing powers of our company and mortgaging the property of our company.

## **Appointment and Removal of Directors**

The Amended PubCo Charter do not limit the maximum number of directors, though this number may be fixed by ordinary resolution.

The Amended PubCo Charter provide that first directors shall be appointed in writing by the subscriber or subscribers to the Amended PubCo Charter, or a majority of them, and thereafter, the directors may be appointed and removed by PubCo's shareholders by ordinary resolution or by the directors.

The Amended PubCo Charter provide for certain circumstances whereby the directors described above must be removed or resign and, if such removal or resignation does not occur, the other directors may remove that director by majority vote. Our directors have a fixed term expiring at the next-following general meeting of PubCo unless re-appointed or removed, and there is no requirement for them to retire by rotation nor to make themselves eligible for re-election. Each director shall remain in office until the end of his/her term or if he or she is removed by ordinary resolution (in the case of each other director) and the office of a director shall be vacated if the director, among other things, (i) he or she is prohibited by the law of the Cayman Islands from acting as a director; (ii) he or she is made bankrupt or makes an arrangement or composition with his/her creditors generally; (iii) he or she resigns his/her office by notice to us; (iv) in the opinion of a registered medical practitioner by whom he/she is being treated he/she becomes physically or mentally incapable of acting as a director; (v) he/she is made subject to any law relating to mental health or incompetence, whether by court order or otherwise; or (vi) without the consent of the other directors, he/she is absent from meetings of directors for a continuous period of six months; or (vii) is removed from office pursuant to any other provision of the Amended PubCo Charter.

## **Committees of the Board of Directors**

Our board of directors will have an audit committee, a compensation committee, and a nominating and corporate committee. Each committee's members and functions are described below.

### ***Audit Committee***

The audit committee will consist of Mr. Timothy Lai Wah Teo, Mr. Heizo Takenaka and Mr. Jean-Francois Raymond Roger Minier. Mr. Timothy Lai Wah Teo will be the chairperson of the audit committee and he satisfies the criteria of an audit committee financial expert as set forth under the applicable rules of the SEC. Each of Mr. Timothy Lai Wah Teo, Mr. Heizo Takenaka and Mr. Jean-Francois Raymond Roger Minier satisfies the requirements for an "independent director" within the meaning of the Nasdaq listing rules and the criteria for independence set forth in Rule 10A-3 of the Exchange Act.

The audit committee will oversee our accounting and financial reporting processes. The audit committee will be responsible for, among other things:

- overseeing the relationship with our independent auditors, including:
  - appointing, retaining and determining the compensation of our independent auditors;
  - approving auditing and pre-approving non-auditing services permitted to be performed by the independent auditors;
  - discussing with the independent auditors the overall scope and plans for their audits and other financial reviews;
  - reviewing a least annually the qualifications, performance and independence of the independent auditors;
  - reviewing reports from the independent auditors regarding all critical accounting policies and practices to be used by us and all other material written communications between the independent auditors and management; and
  - reviewing and resolving any disagreements between management and the independent auditors regarding financial controls or financial reporting;
- overseeing the internal audit function, including conducting an annual appraisal of the internal audit function, reviewing and discussing with management the appointment of the head of internal audit, at least quarterly meetings between the chairperson of the audit committee and the head of internal audit, reviewing any significant issues raised in reports to management by internal audit and ensuring that there are no unjustified restrictions or limitations on the internal audit function and that it has sufficient resources;
- reviewing and recommending all related party transactions to the our board of directors for approval, and reviewing and approving all changes to our related party transactions policy;
- reviewing and discussing with management the annual audited financial statements and the design, implementation, adequacy and effectiveness of our internal controls;
- overseeing risks and exposure associated with financial matters; and
- establishing and overseeing procedures for the receipt, retention and treatment of complaints received from our employees regarding accounting, internal accounting controls or audit matters and the confidential, anonymous submission by our employees of concerns regarding questionable accounting, auditing and internal control matters.

### ***Compensation Committee***

The compensation committee will consist of Mr. Heizo Takenaka, Mr. Jean-Francois Raymond Roger Minier and Mr. Masataka Matsumura. Mr. Heizo Takenaka will be the chairperson of the compensation committee. Each of Mr. Heizo Takenaka and Mr. Jean-Francois Raymond Roger Minier satisfies the requirements for an "independent director" within the meaning of the Nasdaq listing rules. As a controlled company and foreign private issuer, we have elected to not have our compensation committee consist of entirely independent directors.

The compensation committee will be responsible for, among other things:

- reviewing at least annually the goals and objectives of our executive compensation plans, and amending, or recommending that the our board of directors amend, these goals and objectives if the committee deems it appropriate;
- reviewing at least annually our executive compensation plans in light of our goals and objectives with respect to such plans, and, if the committee deems it appropriate, adopting, or recommending to our board of directors the adoption of, new, or the amendment of existing, executive compensation plans;
- evaluating at least annually the performance of our executive officers in light of the goals and objectives of our compensation plans, and determining and approving the compensation of such executive officers, provided that Mr. Masataka Matsumura shall not participate in such determination and approval relating to him personally;
- evaluating annually the appropriate level of compensation for our board of directors and committee service by non-employee directors;
- reviewing and approving any severance or termination arrangements to be made with any of our executive officers, provided that Mr. Masataka Matsumura shall not participate in such determination and approval relating to him personally;
- reviewing perquisites or other personal benefits to our executive officers and directors and recommend any changes to our board of directors; and administering our equity plans.

#### ***Nominating and Corporate Committee***

The nominating and corporate committee will consist of Mr. Heizo Takenaka, Mr. Timothy Lai Wah Teo and Mr. Masataka Matsumura. Each of Mr. Heizo Takenaka and Mr. Timothy Lai Wah Teo satisfies the requirements for an “independent director” within the meaning of the Nasdaq listing rules. Mr. Heizo Takenaka will be the chairperson of the nominating and corporate committee. As a controlled company and foreign private issuer, we have elected to not have our nominating and corporate committee consist of entirely independent directors.

The nominating and corporate committee will assist our board of directors in evaluating nominees to our board of directors and its committees. In addition, the nominating and corporate committee will be responsible for, among other things:

- reviewing annually with our board of directors the characteristics such as knowledge, skills, qualifications, experience and diversity of directors;
- overseeing director training and development programs; and
- advising our board of directors periodically with regards to significant developments in the law and practice of corporate governance as well as compliance with applicable laws and regulations, and making recommendations to our board of directors on all matters of corporate governance and on any remedial action to be taken.

#### **Controlled Company Status**

We are a controlled company because 3DOM Alliance, our majority shareholder, holds more than 50% of our voting power, and we expect we will continue to be a controlled company upon completion of this offering. For so long as we remain a controlled company, we are not required to comply with the following permitted to elect to rely, and may rely, on certain exemptions from the obligation to comply with certain corporate governance requirements, including:

- our board of directors is not required to be comprised of a majority of independent directors.
- our board of directors is not subject to the compensation committee requirement; and
- we are not subject to the requirements that director nominees be selected either by the independent directors or a nomination committee comprised solely of independent directors.

As a result, if we take advantage of these exemptions, you will not have the same protections afforded to shareholders of companies that are subject to all of the Nasdaq corporate governance requirements. We intend to take advantage of these controlled company exemptions. As a result, you may not be provided with the benefits of certain corporate governance requirements of Nasdaq applicable to U.S. domestic public companies. See “*Risk Factors—Because we are a “controlled company” as defined in the Nasdaq Stock Market Rules, you may not have protections of certain corporate governance requirements which otherwise are required by Nasdaq’s rules.*”

## Foreign Private Issuer Status

We are an exempted company limited by shares incorporated in 2022 under the laws of the Cayman Islands. After the consummation of the Business Combination, we will report under the Exchange Act as a non-U.S. company with foreign private issuer status. Under Rule 405 of the Securities Act, the determination of foreign private issuer status is made annually on the last business day of an issuer's most recently completed second fiscal quarter and, accordingly, the next determination will be made with respect to us on December 31, 2023. For so long as we qualify as a foreign private issuer, we will be exempt from certain provisions of the Exchange Act that are applicable to U.S. domestic public companies, including:

- the rules under the Exchange Act requiring the filing of quarterly reports on Form 10-Q or current reports on Form 8-K with the SEC;
- the sections of the Exchange Act regulating the solicitation of proxies, consents, or authorizations in respect of a security registered under the Exchange Act;
- the sections of the Exchange Act requiring insiders to file public reports of our share ownership and trading activities and liability for insiders who profit from trades made in a short period of time; and
- the selective disclosure rules by issuers of material nonpublic information under Regulation Fair Disclosure, or Regulation FD, which regulates selective disclosure of material non-public information by issuers.

We will be required to file an annual report on Form 20-F within four months of the end of each fiscal year. In addition, we intend to publish its results on a semi-annual basis through press releases, distributed pursuant to the rules and regulations of Nasdaq. Press releases relating to financial results and material events will also be furnished to the SEC on Form 6-K. However, the information we are required to file with or furnish to the SEC will be less extensive and less timely compared to that required to be filed with the SEC by U.S. domestic issuers. Accordingly, after the Business Combination, our shareholders will receive less or different information about us than a shareholder of a U.S. domestic public company would receive.

We are a non-U.S. company with foreign private issuer status, and, after the consummation of the Business Combination, will be listed on Nasdaq. Nasdaq market rules permit a foreign private issuer like us to follow the corporate governance practices of our home country. Certain corporate governance practices in the Cayman Islands, which is our home country, may differ significantly from Nasdaq corporate governance listing standards. Among other things, we are not required to have:

- a majority of our board of directors consist of independent directors;
- a compensation committee consisting of independent directors;
- a nominating committee consisting of independent directors; or
- regularly scheduled executive sessions with only independent directors each year.

We intend to rely on the exemptions listed above. As a result, you may not be provided with the benefits of certain corporate governance requirements of Nasdaq applicable to U.S. domestic public companies. See *“Risk Factors—Risks Related to PubCo and Ownership of PubCo’s Shares—PubCo is a company incorporated in the Cayman Islands and will qualify as a foreign private issuer within the meaning of the rules under the Exchange Act, and as such PubCo is exempt from certain provisions applicable to United States domestic public companies.”*

## Code of Business Conduct and Ethics

We will, prior to or concurrently with the listing of PubCo's Ordinary Shares on the Nasdaq, adopt a Code of Business Conduct and Ethics applicable to our directors, officers and employees. We seek to conduct business ethically, honestly, and in compliance with applicable laws and regulations. Our Code of Business Conduct and Ethics sets out the principles designed to guide our business practices with integrity, respect and dedication. The code applies to all directors, officers, employees and extended workforce, including our directors and executive officers. We expect our suppliers, contractors, consultants, and other business partners to follow the principles set forth in its code when providing goods and services to us or acting on our behalf.

## Employment Agreements and Indemnification Agreements

We will enter into an employment agreement with each of our executive officers. The employment of the executive officers under these employment agreements is for an indefinite period, but may be terminated by us for cause at any time without advance notice or for any other reason by giving prior written notice or by paying certain compensation, and the executive officer may terminate his or her employment at any time by giving us prior written notice. The employment agreements with the executive officers also include confidentiality and non-disclosure restrictions and non-competition and non-solicitation restrictions that apply during employment and for certain periods following termination of employment.

We will enter into indemnification agreements with each of our directors. Under these agreements, we may agree to indemnify our director against certain liabilities and expenses incurred by such persons in connection with claims made by reason of their being a director of us.

## Compensation of Directors and Executive Officers

For the year ended June 30, 2022, noco-noco paid an aggregate of approximately S\$0.2 million in cash compensation and benefits in kind to noco-noco's executive officers as a group. In Singapore, noco-noco is required by the applicable laws and regulations to make contributions, as employers, to the Central Provident Fund for executive officers who are employed by noco-noco as prescribed under the Central Provident Fund Act. The contribution rates vary, depending on the age of the executive officers, and whether such executive officer is a Singapore citizen or permanent resident (contributions are not required or permitted in respect of a foreigner on a work pass). Save as aforesaid, noco-noco's executive officers do not receive pension, retirement or other similar benefits, and noco-noco has not set aside or accrued any amount to provide cash benefits to its executive officers. noco-noco paid an aggregate of S\$37,500 in cash compensation to its independent directors for the year ended June 30, 2022. noco-noco is not a party to any agreements with its executive officers and directors that provide for benefits upon termination of employment.

## Share Incentive Plan

### 2023 Equity Incentive Plan

In [month], 2023, our board of directors adopted and our shareholders approved the noco-noco Inc. 2023 Equity Incentive Plan (the "PubCo Incentive Plan"). As of the date of this proxy statement/prospectus, under the PubCo 2023 Plan, dividend equivalents, options, restricted shares, restricted share units, share appreciation rights or other rights or benefits to purchase [6,500,000] noco-noco Ordinary Shares were outstanding.

The following summarizes the material terms of the PubCo Incentive Plan:

- Shares Subject to the PubCo Incentive Plan. Under the terms of the Shareholders' Agreement, the maximum number of PubCo Ordinary Shares that may be issued under the PubCo Incentive Plan from time to time is five percent (5%) of the fully diluted share capital of PubCo as of the date of determination. The maximum aggregate number of PubCo Ordinary Shares which may be subject to awards under the PubCo Incentive Plan initially shall be an aggregate number equal to [6,500,000]. The aggregate number of PubCo Ordinary Shares reserved for awards under the PubCo Incentive Plan will automatically increase on July 1 of each year, for a period of not more than ten (10) years, commencing on July 1 of the year following the year in which the effective date occurs and ending on (and including) July 1, 2033, in an amount equal to five percent (5%) of the total number of PubCo Ordinary Shares outstanding on June 30 of the preceding calendar year. Notwithstanding the foregoing, our board may act prior to July 1 of a given year to provide that there will be no July 1 increase for such year or that the increase for such year will be a lesser number of PubCo Ordinary Shares than provided in the PubCo Incentive Plan.
- Plan Administration. Our board of directors itself or any committee delegated by our board of directors will administer the PubCo Incentive Plan. The administrator, among other things, determines the participants to receive awards, when and how awards will be granted, the type of award to be granted, the number of awards to be granted, and the other terms and conditions of each award.
- Capitalization Adjustment. In the event that the number of outstanding PubCo Ordinary Shares is changed by a share dividend, recapitalization, share split, reverse share split, subdivision, combination, reclassification or other change in our capital structure affecting PubCo Ordinary Shares without consideration, then in order to prevent diminution or enlargement of the benefits or potential benefits intended to be made available under the PubCo Incentive Plan: (a) the number of PubCo Ordinary Shares reserved for issuance under this Plan, (b) the applicable price per PubCo Ordinary Share and number of PubCo Ordinary Shares subject to outstanding awards will be proportionately adjusted, subject to any required action by the our board of directors or our shareholders and compliance with applicable law; provided, however, that fractions of a PubCo Ordinary Share will not be issued but will either be paid in cash at the fair market value of such fraction of a PubCo Ordinary Share or will be rounded down to the nearest whole PubCo Ordinary Share, as determined by the administrator.

- Types of Awards. The PubCo Incentive Plan permits the grants of dividend equivalents, options, restricted shares, restricted share units, and share appreciation rights.
- Eligibility. Our employees, directors and consultants or any of our subsidiaries and affiliates are eligible to participate in the PubCo Incentive Plan, except that pursuant to any applicable laws, grants to non-employees are prohibited.
- Award Agreements. Awards granted under the PubCo Incentive Plan are evidenced by award agreements confirming the grant of awards.
- Conditions of Awards. The administrator determines the provisions, terms and conditions of each dividend equivalent, option, restricted share, restricted share unit, and share appreciation right granted under the PubCo 2023 Plan, including but not limited to the term, timing of grant, and the vesting schedule of the awards.
- Transferability. The awards and all rights thereunder are exercisable only by the participants and are not assignable or transferable, unless otherwise permitted in the award agreement.
- Termination of Employment. Except as may otherwise be provided by the administrator in an award agreement, a grantee's rights in all dividend equivalent rights shall automatically terminate upon the grantee's termination of employment (or cessation of service relationship) with us and our subsidiaries for any reason.
- Term; Amendment. Unless suspended or terminated earlier, the PubCo Incentive Plan has a term of ten years from the date it was adopted by our board of directors (or, if earlier, the date it was approved by our shareholders). Our board of directors has the authority to, at any time; (i) terminate or amend the PubCo Incentive Plan in any respect, including without limitation amendment of any form of award agreement or other instrument to be executed pursuant to PubCo Incentive Plan, provided that any amendment or termination that has a material and adverse effect on the rights of grantees shall require their consents; and, (ii) terminate any and all outstanding options or share appreciation rights upon a winding up or liquidation of our company, followed by the payment of creditors and the distribution of any remaining funds to the our shareholders.

## SECURITY OWNERSHIP OF CERTAIN BENEFICIAL OWNERS AND MANAGEMENT

The following table sets forth information regarding the expected beneficial ownership of PubCo Ordinary Shares immediately following the consummation of the Business Combination by:

- each person who is expected to beneficially own 5.0% or more of the outstanding PubCo Ordinary Shares;
- each executive officer and director nominee of PubCo; and
- all of those executive officers and director nominees of PubCo as a group.

Beneficial ownership is determined in accordance with the rules of the SEC and includes voting or investment power with respect to, or the power to receive the economic benefit of ownership of, the securities. In computing the number of shares beneficially owned by a person and the percentage ownership of that person, shares that the person has the right to acquire within 60 days are included, including through the exercise of any option or other right or the conversion of any other security. However, these shares are not included in the computation of the percentage ownership of any other person.

The expected beneficial ownership of shares of PubCo Ordinary Shares immediately following the consummation of the Business Combination assumes two scenarios:

- a “no redemption” scenario where no PNAC Public Stockholders exercise redemption rights with respect to their PNAC Public Shares; and
- a “maximum redemption” scenario where all PNAC Public Stockholders exercise their redemption rights in respect of 4,912,299 PNAC Public Shares for their pro rata shares of the funds in the Trust Account at a redemption price of \$10.34 per share.

Based on the foregoing assumptions, we estimate that there would be [138,900,625] PubCo Ordinary Shares issued and outstanding immediately following the consummation of the Business Combination in the “no redemption” scenario, and [133,988,326] PubCo Ordinary Shares issued and outstanding immediately following the consummation of the Business Combination in the “maximum redemption” scenario. If the actual facts are different from the foregoing assumptions, ownership figures in the combined company and the columns under Post-Business Combination in the table that follows will be different.

Name of Beneficial Owner	Ordinary Shares Beneficially Owned Immediately Prior to Closing of the Business Combination		Ordinary Shares Beneficially Owned Immediately After Closing of the Business Combination		
	Number of PubCo Ordinary Shares Equivalents	% of PubCo Ordinary Shares Equivalents	Number of PubCo Ordinary Shares	% of PubCo Ordinary Shares (assuming no redemptions)	% of PubCo Ordinary Shares (assuming maximum redemptions)
<b>Directors Nominees and Executive Officers<sup>(1)</sup></b>					
Masataka Matsumura <sup>(2)</sup>	[158,123]	[48.6]	[63,457,090]	[45.7]	[47.4]
Mari Matsushita	—	—	[●]	[●]	[●]
Yuta Akakuma	—	—	[●]	[●]	[●]
Yoshinori Kurahashi	—	—	[●]	[●]	[●]
Tatsuo Mori	—	—	[●]	[●]	[●]
Timothy Lai Wah Teo	—	—	[●]	[●]	[●]
Heizo Takenaka	—	—	[●]	[●]	[●]
Jean-Francois Raymond Roger Minier	—	—	[●]	[●]	[●]
All Director Nominees and Executive Officers as a group ([8] individuals)	[158,123]	[48.6]	[63,457,090]	[45.7]	[47.4]
<b>5.0% Shareholders</b>					
3DOM Alliance <sup>(3)</sup>	[237,908]	[73.1]	[95,476,280]	[68.7]	[71.3]
Future Science Research <sup>(4)</sup>	[27,438]	[8.4]	[11,011,308]	[7.9]	[8.2]
<b>PNAC Sponsors and affiliates</b>			1,921,392	1.38	1.43
Prime Number Acquisition LLC			1,732,732	1.25	1.29
Glorious Capital LLC			140,160	0.10	0.10
Kris Yang			3,500	0.00	0.00
Dongfeng Wang			45,000	0.03	0.03

Notes:

- As of December 26, 2022. Unless otherwise noted, the business address for the directors and executive officers of noco-noco is 4 Shenton Way, #04-06 SGX Centre II, Singapore 068807.
- Represents shares beneficially owned by Mr. Masataka Matsumura through 3DOM Alliance and Future Science Research.
- Consists of [95,476,280] PubCo Ordinary Shares directly held by 3DOM Alliance, a company incorporated under the laws of Japan, which is the majority shareholder of noco-noco. Mr. Masataka Matsumura is the largest shareholder of 3DOM Alliance, who holds [50.3]% its equity interests, as well as the Chief Executive Officer and a Director of PubCo.
- Consists of [11,011,308] PubCo Ordinary Shares directly held by Future Science Research, a company incorporated under the laws of Japan, which is wholly owned by Mr. Masataka Matsumura.



## CERTAIN RELATIONSHIPS AND RELATED PERSON TRANSACTIONS

### **PNAC Relationships and Related Party Transactions**

#### ***Promissory Note - Related Party***

On March 19, 2021, Sponsor A agreed to loan PNAC up to an aggregate amount of \$400,000 to be used, in part, for transaction costs incurred in connection with IPO. The note was unsecured, interest-free and due at the earlier of August 31, 2022 or closing of the IPO. The Sponsor A loaned \$350,000 under such note which was fully repaid by PNAC upon the closing of the IPO on May 17, 2022 and the note was retired accordingly.

#### ***Related Party Loans***

In addition, in order to finance transaction costs in connection with an intended initial business combination, Sponsors, directors, officers or their affiliates of PNAC may, but are not obligated to, loan PNAC funds as may be required. If PNAC completes an initial Business Combination, it would repay such loaned amounts (the "Working Capital Loans"). In the event that the initial business combination does not close, PNAC may use a portion of the working capital held outside the U.S. based Trust Account to repay such loaned amounts but no proceeds from our Trust Account would be used for such repayment. Certain amount of such loans may be convertible into working capital shares at \$10.00 per share at the option of the lender. The working capital shares would be identical to the shares sold in the Private Placement. As of March 31, 2023, the Company had no borrowings under the Working Capital Loans.

On April 23, 2023, DBG Global Limited, a member of Sponsor A, agreed to loan the Company up to \$24,000 to be used for a portion of the working capital. This loan is non-interest bearing, unsecured and is due at the earlier of (1) the date on which the Company consummates its initial business combination or (2) the date on which the Company liquidates. As of March 31, 2023, a total of \$24,000 was drawn by the Company and no balance has been repaid as of the date of this proxy statement/prospectus.

#### ***PNAC Founder Shares***

On April 7, 2021, Sponsor A and Sponsor B acquired 1,357,000 and 80,500 shares of PNAC Class B Common Stock, respectively. On May 28, 2021, Sponsor A and Sponsor B surrendered 271,400 and 16,100 shares of PNAC Class B Common Stock, respectively, without consideration. On December 22, 2021, PNAC effected a 1.5 for 1 stock split of Class B common stock resulting the Sponsors holding 1,725,000 shares of PNAC Class B common Stock. On December 28, 2021, the Sponsors converted their shares of PNAC Class B Common Stock into 1,725,000 shares of PNAC Class A Common Stock on a one-for-one basis (up to 225,000 shares of which are subject to forfeiture to the extent that the underwriters' over-allotment option is not exercised in full or in part). As a result, Sponsor A owns 1,628,400 shares of PNAC Class A Common Stock for an aggregate consideration of \$23,600 and Sponsor B owns 96,600 shares of PNAC Class A Common Stock for an aggregate consideration of \$1,400, or PNAC Founder Shares, for an aggregate consideration of \$25,000, or approximately \$0.01 per share. As a result of the underwriters' partial exercise of their over-allotment option on May 17, 2022, 112,500 PNAC Founder Shares were subject to forfeiture. On June 3, 2022, the Sponsors executed cancellation notices to the transfer agent to forfeit the remaining 112,500 PNAC Founder Shares for no consideration.

The holders of PNAC Founder Shares have agreed, subject to certain limited exceptions, not to transfer, assign or sell any of their PNAC Founder Shares until, with respect to 50% of the PNAC Founder Shares, the earlier of six months after the consummation of a business combination and the date on which the closing price of the PNAC Class A Common Stock equals or exceeds \$12.50 per share (as adjusted for stock splits, stock dividends, reorganizations, recapitalizations and the like) for any 20 trading days within a 30-trading day period commencing after a business combination and, with respect to the remaining 50% of the insider shares, until the six months after the consummation of a Business Combination, or earlier, in either case, if, subsequent to a business combination, PNAC completes a liquidation, merger, stock exchange or other similar transaction which results in all of the PNAC stockholders having the right to exchange their shares of common stock for cash, securities or other property.

#### ***PNAC Private Shares***

Simultaneously with the IPO, PNAC completed the private sale of 398,892 shares of PNAC Class A Common Stock, or PNAC Private Shares, to the Sponsors, including 349,032 shares to Sponsor A and 49,860 shares to Sponsor B, at a purchase price of \$10.00 per share, generating gross proceeds of \$3,988,920 (including \$3,490,320 from Sponsor A and \$498,600 from Sponsor B). The Sponsors have agreed not to transfer, assign or sell any of their PNAC Private Shares until the closing of an initial business combination.

### ***Administrative Services Agreement***

PNAC has agreed, commencing on the effective date of the prospectus, to pay Sponsor A up to \$10,000 per month for office space, administrative and shared personnel support services. However, pursuant to the terms of such agreement, PNAC may delay payment of such monthly fee upon a determination by the audit committee that there are insufficient funds held outside the trust to pay actual or anticipated expenses in connection with the initial business combination. Any such unpaid amount will accrue without interest and be due and payable no later than the date of the consummation of the initial business combination. This arrangement will terminate upon the earlier of (a) completion of a business combination or (b) twelve months after the completion of the initial public offering. The Company incurred \$106,129 and \$76,129, respectively, in fees for office space, administrative and shared personnel support services at March 31, 2023 and December 31, 2022, respectively.

### **noco-noco and PubCo Relationships and Related Party Transactions**

#### ***Promissory Note***

On August 1, 2020, noco-noco issued a promissory note with 3DOM Alliance (the “Note”). The Note provides for borrowings upon the request of noco-noco, on one or more occasions, up to the principal amount of S\$1.0 million (\$0.7 million). The principal amount was extended to S\$3.0 million (\$2.2 million) on January 23, 2023, and further extended to S\$8.0 million (\$5.8 million) on February 6, 2023. No interest shall accrue to any loans under the Note. There are no payment schedules under the Note; however, the Note must be repaid upon 3DOM Alliance’s request or certain events of default. As of [May 15], 2023, we had drawn down an aggregate amount of S\$[6.41] million (\$[4.82] million).

#### ***Issuance of Shares pursuant to Debt-to-Equity Swaps***

On October 22, 2021, noco-noco allotted and issued 15,478 new ordinary shares in its capital, at \$100 per share, to 3DOM Alliance, pursuant to a debt-to-equity swap which both parties agreed to convert noco-noco’s debt of \$1.5 million owed to 3DOM Alliance into new ordinary shares in the capital of noco-noco.

On July 15, 2022, noco-noco allotted and issued another 759 new ordinary shares in its capital, at the issue price of \$1,041.22, to 3DOM Alliance, pursuant to another debt-to-equity swap which both parties agreed to convert noco-noco’s debt of \$0.8 million owed to 3DOM Alliance into new ordinary shares in the capital of noco-noco.

#### ***2021 License-in Agreement***

On August 18, 2021, noco-noco entered into an exclusive, irrevocable license-in agreement (“the 2021 license-in agreement”) with 3DOM Alliance. Pursuant to the agreement, 3DOM Alliance granted a license to certain of its proprietary patents, trademarks and other intellectual properties to noco-noco, in return for royalties of the sum equal to 1.5% of noco-noco’s revenue. The 2021 license-in agreement was amended once on August 29, 2022 and was terminated on November 22, 2022.

### ***License-in Agreement***

On November 22, 2022, noco-noco entered into a new exclusive, irrevocable license-in agreement with 3DOM Alliance. Pursuant to such agreement, 3DOM Alliance granted noco-noco the exclusive rights to utilize certain of its proprietary and licensed-in patents and other intellectual property, as well as confidential yet critical know-how and other information for a perpetual term, in return for quarterly royalties equal to three percent (3%) of the gross profit generated using each of 3DOM IP Rights. In addition, noco-noco is obligated to pay a one-off, refundable upfront payment of \$30 million licensing fee to 3DOM Alliance. Such upfront payment shall be credited against any royalties under the agreement such that the amount of the upfront payment shall be deducted from the royalties when due and payable. In the event that the upfront payment has any remaining amount after the last deduction from the royalties at the end of a five-year period from the last instalment of the upfront payment, the remaining unutilized amount shall be refunded to us at our request. Pursuant to a supplemental agreement to the license-in agreement dated May 10, 2023 (the “Supplemental Agreement”), the upfront payment shall be payable over a series of instalments after the consummation of the Business Combination, in such amounts and pursuant to such repayment schedule as may be agreed between 3DOM Alliance and us. Both parties shall negotiate the instalment plan in good faith, taking into consideration our working capital needs as well as our liquidity and available capital resources after the consummation of the Business Combination. As of the date of the proxy/registration statement, we had not paid any upfront payments to 3DOM Alliance yet. See “*noco-noco’s Business—Relationship with 3DOM Alliance*” for more details.

### ***Employment Agreements and Indemnification Agreements***

See “*Management of PubCo following the Business Combination—Employment Agreements and Indemnification Agreements.*”

### ***noco-noco Lock-up Agreements***

Prior to or upon the consummation of the Business Combination, PNAC, PubCo, PNAC Initial Insiders (as defined in the Lock-up Agreement), and certain of the shareholders of noco-noco will enter into a lock-up agreement (the “Lock-up Agreement”), pursuant to which the Initial Insiders and certain shareholders of noco-noco will agree not to sell, assign, offer to sell, contract or agreement to sell, hypothecate, pledge, grant of any option to purchase or otherwise dispose of or agreement to dispose of, directly or indirectly, or establishment or increase of a put equivalent position or liquidation with respect to or decrease of a call equivalent position within the meaning of Section 16 of the Securities Exchange Act of 1934, as amended, and the rules and regulations of the Commission promulgated thereunder with respect to, any of the Lock-up Shares (as defined in the Lock-up Agreement); (b) entry into any swap or other arrangement that transfers to another, in whole or in part, any of the economic consequences of ownership of any of the Lock-up Shares, whether any such transaction is to be settled by delivery of such Lock-up Shares, in cash or otherwise; (c) make public announcement of any intention to effect any transaction specified in clause (a) or (b) above; or (d) engage in any short sales (as defined in the Lock-up Agreement) with respect to any security of PubCo, for a period of six months following the Share Exchange Closing Date with respect to PNAC Founder Shares and PubCo Ordinary Shares that certain shareholders of noco-noco will receive in connection with the Share Exchange, and for a period of 30 days following the Share Exchange Closing Date with respect to PNAC Private Shares and Working Capital Loan Shares, if any. Such lock-up period may end earlier if certain conditions occur as provided in the Lock-up Agreement.

For more information about the Lock-up Agreements, see “*Shares Eligible for Future Sale—Lock-up Agreements.*”

### ***Registration Rights Agreement***

See “*Shares Eligible for Future Sale—Registration Rights.*”

### ***Equity Incentive Plans***

See “*Management of PubCo Following the Business Combination—Share Incentive Plan.*”

## DESCRIPTION OF PUBCO SECURITIES

*The following description of the material terms of the securities of PubCo following the closing of the Business Combination includes a summary of specified provisions of the Amended PubCo Charter that will be in effect upon closing of the Business Combination. This description is qualified by reference to the Amended PubCo Charter as will be in effect upon consummation of the Business Combination, substantially in the form attached to this proxy statement/prospectus as Annex B and incorporated in this proxy statement/prospectus by reference. In this section, the terms “we,” “our” or “us” refer to PubCo following the closing of the Business Combination, and all capitalized terms used in this section are as defined in the Amended PubCo Charter, unless elsewhere defined herein.*

PubCo is a Cayman Islands exempted company and its affairs are governed by the Amended PubCo Charter, the Cayman Companies Act and the common law of the Cayman Islands.

PubCo is authorized to issue 500,000,000 ordinary shares, \$0.0001 par value each.

PubCo currently has only one class of issued ordinary shares, which have identical rights in all respects and rank equally with one another.

As of the date of this proxy statement/prospectus, there is [one] PubCo Ordinary Share issued and outstanding.

### **New Ordinary Shares**

#### **General**

Holders of PubCo Ordinary Shares will be entitled to one vote for each share held of record on all matters to be voted on by shareholders. None of the holders of PubCo Ordinary Shares have different voting rights from the other holders after the completion of this offering.

Holders of PubCo Ordinary Shares will not have any conversion, pre-emptive or other subscription rights under the Amended PubCo Charter and there will be no sinking fund or redemption provisions applicable to the PubCo Ordinary Shares.

#### **Dividends**

Subject to the foregoing, the payment of cash dividends in the future, if any, will be at the discretion of PubCo's board of directors and will depend upon such factors as earnings levels, capital requirements, contractual restrictions, PubCo's overall financial condition, available distributable reserves and any other factors deemed relevant by PubCo's board of directors. Under Cayman Islands law, a Cayman Islands company may pay a dividend out of either profits (including retained earnings) or share premium, provided that in no circumstances may a dividend be paid if this would result in PubCo being unable to pay its debts as they fall due in the ordinary course of its business.

Even if PubCo's board of directors decides to pay dividends, the form, frequency and amount will depend upon PubCo's future operations and earnings, capital requirements and surplus, general financial condition, contractual restrictions and other factors that PubCo's board of directors may deem relevant. In addition, PubCo is a holding company and depends on the receipt of dividends and other distributions from its subsidiaries to pay dividends on PubCo Ordinary Shares. When making recommendations on the timing, amount and form of future dividends, if any, PubCo's board of directors will consider, among other things:

- PubCo's results of operations and cash flow;
- PubCo's expected financial performance and working capital needs;
- PubCo's future prospects;
- PubCo's capital expenditures and other investment plans;
- other investment and growth plans;
- dividend yields of comparable companies globally;
- restrictions on payment of dividend that may be imposed on us by financing arrangements; and
- the general economic and business conditions and other factors deemed relevant by our board of directors and statutory restrictions on the payment of dividends.

### ***Liquidation***

On a winding-up or other return of capital, subject to any special rights attaching to any other class of shares, holders of PubCo Ordinary Shares will be entitled to participate in any surplus assets in proportion to their shareholdings.

### ***Transfers of Shares***

Subject to the restrictions contained in the Amended PubCo Charter and the rules or regulations of the Designated Stock Exchange (as defined in the Amended PubCo Charter) or any relevant securities laws, any PubCo shareholders may transfer all or any of his or her PubCo Ordinary Shares by an instrument of transfer in writing and in the usual or common form or in a form prescribed by the Designated Stock Exchange or in any other form approved by the PubCo directors.

The PubCo directors have absolute discretion to decline to register any transfer of PubCo Ordinary Shares which are not fully paid up, or on which PubCo has a lien, and shall upon making any decision to decline to register any transfer of PubCo Ordinary Shares assign an appropriate reason therefor. If PubCo directors refuse to register a transfer of any PubCo Ordinary Shares, they shall within three months after the date on which the instrument of transfer was lodged with PubCo send to each of the transferor and the transferee notice of the refusal. The PubCo directors may also, but are not required to, decline to register any transfer of a PubCo Ordinary Share unless:

- the instrument of transfer is lodged with PubCo, accompanied by the certificate (if any) for the shares to which it relates and such other evidence as the board may reasonably require to show the right of the transferor to make the transfer;
- the instrument of transfer is in respect of only one class of shares;
- the instrument of transfer is properly stamped, if required;
- in the case of a transfer to joint holders, the number of joint holders to whom the share is to be transferred does not exceed four;
- the shares transferred are fully paid up and free of any lien in favor of the PubCo; and
- any applicable fee of such maximum sum as the designated stock exchanges may determine to be payable, or such lesser sum as the board may from time to time require, related to the transfer is paid to PubCo.

### ***Calls on Shares and Forfeiture of Shares***

PubCo's board of directors may, subject to the terms of allotment, make calls upon shareholders for any amounts unpaid on their PubCo Ordinary Shares. Any PubCo Ordinary Shares that have been called upon and remain unpaid are, after a notice period, subject to forfeiture.

### ***Redemption and Repurchase of Shares***

Subject to the provisions of the Cayman Companies Act, and to any rights for the time being conferred on the shareholders holding a particular class of shares, and, where applicable, the rules and regulations of the designated stock exchange, and/or other competent regulatory authority or otherwise under applicable law, PubCo may, by its directors, issue shares that are to be redeemed or are liable to be redeemed at the option of the shareholder holding such redeeming shares or PubCo. The redemption of such shares will be effected in such manner and upon such other terms as PubCo's directors, determine before the issue of the shares. PubCo may also, with the consent by special resolution of the shareholders holding shares of a particular class, vary the rights attaching to that class of shares so as to provide that those shares are to be redeemed or are liable to be redeemed at the option of the PubCo on the terms and in the manner which the directors determine at the time of such variation. Subject to compliance with the Cayman Companies Act, PubCo may also purchase its own shares (including any redeemable shares) on such terms and in such manner as the directors may determine and agree with the relevant shareholder(s).

## **Special Considerations for Exempted Companies**

PubCo is an exempted company with limited liability under the Cayman Companies Act. The Cayman Companies Act distinguishes between ordinary resident companies and exempted companies. Any company that is registered in the Cayman Islands but conducts business mainly outside of the Cayman Islands may apply to be registered as an exempted company. The requirements for an exempted company are essentially the same as for an ordinary company except for the exemptions and privileges listed below:

- an exempted company does not have to file an annual return of its shareholders with the Registrar of Companies of the Cayman Islands;
- an exempted company's register of members is not open to inspection;
- an exempted company does not have to hold an annual general meeting;
- an exempted company may issue shares with no par value;
- an exempted company may obtain an undertaking against the imposition of any future taxation (such undertakings are usually given for 20 years in the first instance);
- an exempted company may register by way of continuation in another jurisdiction and be deregistered in the Cayman Islands;
- an exempted company may register as a limited duration company; and
- an exempted company may register as a segregated portfolio company.

"Limited liability" means that the liability of each shareholder is limited to the amount unpaid by the shareholder on the shares of the company (except in exceptional circumstances, such as involving fraud, the establishment of an agency relationship or an illegal or improper purpose or other circumstances in which a court may be prepared to pierce or lift the corporate veil).

## **Differences in Company Law**

Cayman Islands companies are governed by the Cayman Companies Act. The Cayman Companies Act is derived, to a large extent, from the older Companies Acts of England and Wales but does not follow recent United Kingdom statutory enactments, and accordingly there are significant differences between the Cayman Companies Act and the current Companies Act of the UK. In addition, the Cayman Companies Act differs from laws applicable to United States corporations and their shareholders. Set forth below is a summary of the material differences between the provisions of the Cayman Companies Act applicable to us and the laws applicable to companies incorporated in the United States and their shareholders.

## ***Mergers and Similar Arrangements***

The Cayman Companies Act permits mergers and consolidations between Cayman Islands companies and between Cayman Islands companies and non-Cayman Islands companies provided that the laws of the foreign jurisdiction permit such merger or consolidation. For these purposes, (a) "merger" means the merging of two or more constituent companies and the vesting of their undertaking, property and liabilities in one of such companies as the surviving company, and (b) a "consolidation" means the combination of two or more constituent companies into a new consolidated company and the vesting of the undertaking, property and liabilities of such companies to the consolidated company. In order to effect such a merger or consolidation, the directors of each constituent company must approve a written plan of merger or consolidation, which must then be authorized by (a) a special resolution of the shareholders of each constituent company, and (b) such other authorization, if any, as may be specified in such constituent company's articles of association. The plan must be filed with the Registrar of Companies together with a declaration as to the solvency of the consolidated or surviving company, a list of the assets and liabilities of each constituent company and an undertaking that a copy of the certificate of merger or consolidation will be given to the shareholders and creditors of each constituent company and that notification of the merger or consolidation will be published in the Cayman Islands Gazette. Court approval is not required for a merger or consolidation which is affected in compliance with these statutory procedures.

A merger between a Cayman parent company and its Cayman subsidiary or subsidiaries does not require authorization by a resolution of shareholders. For this purpose, a subsidiary is a company of which at least 90% of the issued shares entitled to vote are owned by the parent company.

The consent of each holder of a fixed or floating security interest of a constituent company is required unless this requirement is waived by a court in the Cayman Islands.

Except in certain limited circumstances, a dissenting shareholder of a Cayman Islands constituent company is entitled to payment of the fair value of his or her shares upon dissenting from a merger or consolidation. The exercise of such dissenter rights will preclude the exercise by the dissenting shareholder of any other rights to which he or she might otherwise be entitled by virtue of holding shares, except for the right to seek relief on the grounds that the merger or consolidation is void or unlawful.

In addition, there are statutory provisions that facilitate the reconstruction and amalgamation of companies, provided that the arrangement is approved by seventy-five percent (75%) in value of the shareholders or class of shareholders or creditors, as the case may be, that are present and voting either in person or by proxy at a meeting, or meetings, convened for that purpose. The convening of the meetings and subsequently the arrangement must be sanctioned by the Grand Court of the Cayman Islands. While a dissenting shareholder has the right to express to the court the view that the transaction ought not to be approved, the court can be expected to approve the arrangement if it determines that:

- the statutory provisions as to the required majority vote have been met;
- the shareholders have been fairly represented at the meeting in question and the statutory majority are acting bona fide without coercion of the minority to promote interests adverse to those of the class;
- the arrangement is such that may be reasonably approved by an intelligent and honest man of that class acting in respect of his interest; and
- the arrangement is not one that would more properly be sanctioned under some other provision of the Cayman Companies Act.

### ***Squeeze-out Provisions***

When a takeover offer is made and accepted by holders of 90% of the shares affected within four months, the offeror may, within a two-month period commencing on the expiration of such four-month period, require the holders of the remaining shares to transfer such shares on the terms of the offer. An objection can be made to the Cayman Islands courts, but this is unlikely to succeed unless there is evidence of fraud, bad faith or collusion.

If an arrangement and reconstruction is thus approved, or if a takeover offer is made and accepted, a dissenting shareholder would have no rights comparable to appraisal rights, which would otherwise ordinarily be available to dissenting shareholders of Delaware corporations, providing rights to receive payment in cash for the judicially determined value of the shares.

Further, transactions similar to a merger, reconstruction and/or an amalgamation may in some circumstances be achieved through means other than these statutory provisions, such as a share capital exchange, asset acquisition or control, or through contractual arrangements of an operating business.

### ***Shareholders Suits***

Derivative actions have been brought in the Cayman Islands courts, and the Cayman Islands courts have confirmed the availability for such actions. In principle, we will normally be the proper plaintiff to sue for a wrong done to us as a company and as a general rule, a derivative action may not be brought by a minority shareholder. However, based on English law authorities, which would in all likelihood be of persuasive authority in the Cayman Islands, the Cayman Islands courts can be expected to follow and apply the common law principles (namely the rule in *Foss v. Harbottle* and the exceptions thereto) so that a non-controlling shareholder may be permitted to commence a class action against or derivative actions in the name of the company to challenge:

- an act which is illegal or ultra vires with respect to the company and is therefore incapable of ratification by the shareholders;
- an act which, although not ultra vires, requires authorization by a qualified (or special) majority (that is, more than a simple majority) which has not been obtained; and
- an act which constitutes a “fraud on the minority” where the wrongdoers are themselves in control of the company.

### ***Indemnification of Directors and Executive Officers and Limitation of Liability***

Cayman Islands law does not limit the extent to which a company's articles of association may provide for indemnification of officers and directors, except to the extent any such provision may be held by the Cayman Islands courts to be contrary to public policy, such as to provide indemnification against civil fraud or the consequences of committing a crime, or against the indemnified person's own fraud or dishonesty. The Amended PubCo Charter provide to the extent permitted by law, PubCo shall indemnify each existing or former secretary, director (including alternate director), and any of PubCo other officers (including an investment adviser or an administrator or liquidator) and their personal representatives against:

- all actions, proceedings, costs, charges, expenses, losses, damages or liabilities incurred or sustained by the existing or former director (including alternate director), secretary or officer in or about the conduct of our business or affairs or in the execution or discharge of the existing or former director's (including alternate director's), secretary's or officer's duties, powers, authorities or discretions; and
- without limitation to paragraph (a) above, all costs, expenses, losses or liabilities incurred by the existing or former director (including alternate director), secretary or officer in defending (whether successfully or otherwise) any civil, criminal, administrative or investigative proceedings (whether threatened, pending or completed) concerning us or our affairs in any court or tribunal, whether in the Cayman Islands or elsewhere.

No such existing or former director (including alternate director), secretary or officer, however, shall be indemnified in respect of any matter arising out of his own actual fraud, willful default or willful neglect.

To the extent permitted by law, PubCo may make a payment, or agree to make a payment, whether by way of advance, loan or otherwise, for any legal costs incurred by an existing or former director (including alternate director), secretary or any of officers of PubCo in respect of any matter identified in above on condition that the director (including alternate director), secretary or officer must repay the amount paid by PubCo to the extent that it is ultimately found not liable to indemnify the director (including alternate director), the secretary or that officer for those legal costs.

This standard of conduct is generally the same as permitted under the DGCL for a Delaware corporation.

Insofar as indemnification for liabilities arising under the Securities Act may be permitted to PubCo's directors, officers, secretaries or persons controlling us under the foregoing provisions, PubCo has been informed that, in the opinion of the SEC, such indemnification is against public policy as expressed in the Securities Act and is therefore unenforceable.

### ***Directors' Fiduciary Duties***

Under Delaware corporate law, a director of a Delaware corporation has a fiduciary duty to the corporation and its shareholders. This duty has two components: the duty of care and the duty of loyalty. The duty of care requires that a director act in good faith, with the care that an ordinarily prudent person would exercise under similar circumstances. Under this duty, a director must inform himself or herself of, and disclose to shareholders, all material information reasonably available regarding a significant transaction. The duty of loyalty requires that a director act in a manner he or she reasonably believes to be in the best interests of the corporation. A director must not use his or her corporate position for personal gain or advantage. This duty prohibits self-dealing by a director and mandates that the best interest of the corporation and its shareholders take precedence over any interest possessed by a director, officer or controlling shareholder and not shared by the shareholders generally. In general, actions of a director are presumed to have been made on an informed basis, in good faith and in the honest belief that the action taken was in the best interests of the corporation. However, this presumption may be rebutted by evidence of a breach of one of the fiduciary duties. Should such evidence be presented concerning a transaction by a director, a director must prove the procedural fairness of the transaction, and that the transaction was of fair value to the corporation.



As a matter of Cayman Islands law, a director owes three types of duties to the company: (i) statutory duties, (ii) fiduciary duties, and (iii) common law duties. The Cayman Companies Act imposes a number of statutory duties on a director. A Cayman Islands director's fiduciary duties are not codified, however the courts of the Cayman Islands have held that a director owes the following fiduciary duties (a) a duty to act in what the director bona fide considers to be in the best interests of the company, (b) a duty to exercise their powers for the purposes they were conferred, (c) a duty to avoid fettering his or her discretion in the future and (d) a duty to avoid conflicts of interest and of duty. The common law duties owed by a director are those to act with skill, care and diligence that may reasonably be expected of a person carrying out the same functions as are carried out by that director in relation to the company and, also, to act with the skill, care and diligence in keeping with a standard of care commensurate with any particular skill they have which enables them to meet a higher standard than a director without those skills. In fulfilling their duty of care to us, the directors must ensure compliance with the company's articles. PubCo has the right to seek damages where certain duties owed by any of PubCo's directors are breached.

### ***General Meetings of Shareholders***

PubCo may, but shall not (unless required by the Designated Stock Exchange Rules) be obligated to, hold an annual general meeting at such time and place as the board of directors of PubCo will determine. At least 21 clear days' notice shall be given for of an annual general meeting and at least 14 clear days' notice shall be given for any other general meeting. The board of directors of PubCo may call extraordinary general meetings, and must convene an extraordinary general meeting upon the requisition of one or more shareholders who together hold at least ten per cent of the rights to vote at such general Meeting. One or more shareholders holding not less than one-third of the PubCo Ordinary Shares carrying the right to vote at such general meeting present in person or by proxy and entitled to vote will be a quorum for all purposes.

### ***Shareholder Action by Written Consent***

Under the DGCL, a corporation may eliminate the right of shareholders to act by written consent by amendment to its certificate of incorporation. The Amended PubCo Charter provide that, subject to satisfaction of the requirements therein, shareholders may approve corporate matters by way of a written resolution signed by or on behalf of not less than a simple majority of shareholders (in the case of an ordinary resolution) or by all shareholders (in the case of special resolution) who would have been entitled to vote on such matter at a general meeting without a meeting being held.

### ***Shareholder Proposals***

Under the DGCL, a shareholder has the right to put any proposal before the annual meeting of shareholders, provided it complies with the notice provisions in the governing documents. A special meeting may be called by the board of directors or any other person authorized to do so in the governing documents, but shareholders may be precluded from calling special meetings.

The Cayman Companies Act provides shareholders with only limited rights to requisition a general meeting, and does not provide shareholders with any right to put any proposal before a general meeting. However, these rights may be provided in a company's articles of association. The Amended PubCo Charter permit one or more shareholders who together hold at least ten per cent of the rights to vote at such general meeting to requisition a general meeting.

### ***Matters Requiring Shareholder Approval***

A special resolution, requiring not less than a two-thirds votes (or a unanimous written resolution), is required to:

- amend the Amended PubCo Charter;
- register PubCo by way of continuation in a jurisdiction outside the Cayman Islands, or such other jurisdiction in which it is, for the time being, incorporated, registered or existing;
- validate any prior or future act of the PubCo's directors which would otherwise be in breach of their duties;

- release any existing or former director (including alternate director), secretary or other officer of PubCo from liability for any loss or damage or right to compensation which may arise out of or in connection with the execution or discharge of the duties, powers, authorities or discretions of his/her office;
- issue redeemable shares and to purchase own shares;
- merge or consolidate with one or more constituent companies;
- reduce PubCo's share capital in any manner authorized by law;
- vary the rights attaching to a class of shares of PubCo;
- change PubCo's name or amend the PubCo's memorandum of association; or
- wind-up PubCo voluntarily.

### ***Cumulative Voting***

Under the DGCL, cumulative voting for elections of directors is not permitted unless the corporation's certificate of incorporation specifically provides for it. Cumulative voting potentially facilitates the representation of minority shareholders on a board of directors since it permits the minority shareholder to cast all the votes to which the shareholder is entitled on a single director, which increases the shareholder's voting power with respect to electing such director. As permitted under Cayman Islands law, the Amended PubCo Charter do not provide for cumulative voting. As a result, PubCo's shareholders are not afforded any less protections or rights on this issue than shareholders of a Delaware corporation.

### ***Appointment and Removal of Directors***

Under the DGCL, a director of a corporation with a classified board may be removed only for cause with the approval of a majority of the issued and outstanding shares entitled to vote, unless the certificate of incorporation provides otherwise. Under the Amended PubCo Charter, PubCo's board may comprise not less than three directors (provided however, may be increased or reduced by Ordinary Resolution) and the maximum number of directors shall be unlimited unless fixed by ordinary resolution. First directors shall be appointed in writing by the subscriber or subscribers to the Amended PubCo Charter, or a majority of them, and thereafter, directors may be appointed and removed by PubCo's shareholders by ordinary resolution or by the directors. The removal of a director by ordinary resolution may be for any reason and need not be for cause. A director will also cease to be a director if he or she (i) is prohibited by the law of the Cayman Islands from acting as a director; (ii) is made bankrupt or makes an arrangement or composition with his/her creditors generally; (iii) resigns his/her office by notice to the Company; (iv) becomes physically or mentally incapable of acting as a director, in the opinion of a registered medical practitioner by whom he/she is being treated; (v) is made subject to any law relating to mental health or incompetence, whether by court order or otherwise; (vi) is absent from meetings of Directors for a continuous period of six months, without the consent of the other directors; or (vii) is removed from office pursuant to any other provision of the Amended PubCo Charter.

### ***Transactions with Interested Shareholders***

The DGCL contains a business combination statute applicable to Delaware corporations whereby, unless the corporation has specifically elected not to be governed by such statute under its certificate of incorporation, it is prohibited from engaging in certain business combinations with an "interested shareholder" for three years following the date that such person becomes an interested shareholder. An interested shareholder generally is a person or a group who or which owns or owned 15% or more of the target's outstanding voting stock within the past three years. This has the effect of limiting the ability of a potential acquirer to make a two-tiered bid for the target in which all shareholders would not be treated equally. The statute does not apply if, among other things, prior to the date on which such shareholder becomes an interested shareholder, the board of directors approves either a business combination or the transaction which resulted in the person becoming an interested shareholder. This encourages any potential acquirer of a Delaware corporation to negotiate the terms of any acquisition transaction with the target's board of directors.

Cayman Islands law has no comparable statute. As a result, PubCo cannot avail ourselves of the types of protections afforded by the Delaware business combination statute. However, although Cayman Islands law does not regulate transactions between a company and its significant shareholders, it does provide that such transactions must be entered into bona fide in the best interests of the company and for a proper corporate purpose and not with the effect of constituting a fraud on the minority shareholders.

### ***Dissolution; Winding Up***

Under the DGCL, unless the board of directors approves the proposal to dissolve, dissolution must be approved by shareholders holding 100% of the total voting power of the corporation. Only if the dissolution is initiated by the board of directors may it be approved by a simple majority of the corporation's outstanding shares. Delaware law allows a Delaware corporation to include in its certificate of incorporation a supermajority voting requirement in connection with dissolutions initiated by the board.

Under Cayman Islands law, a company may be wound up by either an order of the courts of the Cayman Islands or by a special resolution of its members or, if the company is unable to pay its debts as they fall due, by an ordinary resolution of its members. The court has authority to order winding up in a number of specified circumstances including where it is, in the opinion of the court, just and equitable to do so.

Under the Amended PubCo Charter, if the Company is wound up, the shareholders may, subject to the provisions of the Amended PubCo Charter and any other sanction required by the Cayman Companies Act, pass a special resolutions allowing the liquidator of PubCo's company to divide in specie among the PubCo's shareholders the whole or any part of the assets of PubCo and/or vest the whole or any part of the assets in trustees for the benefit of PubCo's shareholders and those liable to contribute to the winding up.

### ***Variation of Rights of Shares***

Under the DGCL, a corporation may vary the rights of a class of shares with the approval of a majority of the outstanding shares of such class, unless the certificate of incorporation provides otherwise.

Under the Amended PubCo Charter, if PubCo's share capital is divided into different classes (unless the terms on which a class of shares was issued state otherwise) the rights attached to any such class may, subject to any rights or restrictions for the time being attached to any class, only be varied with the consent in writing of the holders of not less than two-thirds of the issued shares of the relevant class, or with the sanction of special resolution passed at a separate general meeting of the holders of the shares of such class.

### ***Amendment of Governing Documents***

Under the DGCL, a corporation's governing documents may be amended with the approval of a majority of the outstanding shares entitled to vote on the matter, unless the certificate of incorporation provides otherwise.

As permitted by Cayman Islands law, the Amended PubCo Charter may only be amended by a special resolution of the shareholders.

### ***Rights of Non-Resident or Foreign Shareholders***

There are no limitations imposed by the Amended PubCo Charter on the rights of non-resident or foreign shareholders to hold or exercise voting rights on PubCo's shares. In addition, there are no provisions in the Amended PubCo Charter governing the ownership threshold above which shareholder ownership must be disclosed.

### ***Directors' Power to Issue Shares***

Subject to applicable law, PubCo's board of directors is empowered to issue or allot shares or grant options and warrants with or without preferred, deferred, or other rights or restrictions. No share may be issued at a discount except in accordance with the provisions of the Cayman Companies Act.

### ***Directors' Voting Rights***

The Amended PubCo Charter provide that its directors may vote on resolutions relating to any contract or proposed contract or arrangement in which he/she is interested (and count as part of the quorum at any meetings where any such contract or proposed contract or arrangement is being considered) provided that such director discloses any material interest in accordance with the terms of the Amended PubCo Charter. This would include, for example, the right to vote on his/her own compensation arrangements (and that of any other director) and any arrangements in respect of such director borrowing money from the Company. The Amended PubCo Charter also permit the directors to exercise all of the powers of PubCo to borrow money and to mortgage or charge its undertaking, property and assets both present and future and uncalled capital, or any part thereof, and to issue debentures and other securities. These provisions may be varied by a shareholders' special resolution to make corresponding amendments to the Amended PubCo Charter.

The above is also subject to the PubCo directors' ongoing adherence to their fiduciary duties (including to act in the best interests of the company).

### ***Inspection of Books and Records***

Under the DGCL, any shareholder of a corporation may for any proper purpose inspect or make copies of the corporation's stock ledger, list of shareholders and other books and records.

Holders of PubCo's shares have no general right under Cayman Islands law to inspect or obtain copies of PubCo's register of members or PubCo's corporate records (other than the Amended PubCo Charter, its register of mortgages and charges, and any special resolutions passed by its shareholders).

### ***Changes in Capital***

Subject to the Cayman Companies Act, PubCo may from time to time by ordinary resolution:

- increase its share capital by new shares of the amount fixed by that ordinary resolution and with the attached rights, priorities and privileges set out in that ordinary resolution;
- consolidate and divide all or any of its share capital into shares of larger amount than its existing shares;
- convert all or any of its paid up shares into stock, and reconvert that stock into paid up shares of any denomination;
- sub-divide its shares or any of them into shares of an amount smaller than that fixed by Amended PubCo Charter, so, however, that in the sub-division, the proportion between the amount paid and the amount, if any, unpaid on each reduced share shall be the same as it was in case of the share from which the reduced share is derived; and
- cancel any shares that, at the date of the passing of the ordinary resolution, have not been taken or agreed to be taken by any person and diminish the amount of its share capital by the amount of the share so canceled, or, in the case of shares without nominal par value, diminish the number of shares into which its capital is divided.

PubCo may by special resolution reduce its share capital in any manner permitted by law.

### ***Warrants***

Upon the consummation of the Business Combination, each PNAC Warrant outstanding immediately prior to the consummation of the Business Combination shall be assumed by PubCo and converted into a PubCo Warrant. Each PubCo Warrant will continue to have and be subject to substantially the same terms and conditions as were applicable to such PNAC Warrant immediately prior to the consummation of the Business Combination (including any repurchase rights and cashless exercise provisions).

## **Enforceability of Civil Liability under Cayman Islands Law**

There is uncertainty as to whether the courts of the Cayman Islands would (i) recognize, or enforce against PubCo, judgments of courts of the United States predicated upon the civil liability provisions of the securities laws of the United States or any State; and (ii) entertain original actions brought in each respective jurisdiction against PubCo or PubCo directors or officers predicated upon the civil liability provisions of the securities laws of the United States or any State. In those circumstances, although there is no statutory enforcement in the Cayman Islands of judgments obtained in the United States, the courts of the Cayman Islands will in certain circumstances recognize and enforce a foreign money judgment of a foreign court of competent jurisdiction without re-examination or retrial of matters adjudicated upon, provide that such judgment (i) is given by a foreign court of competent jurisdiction; (ii) imposes on the judgment debtor a liability to pay a liquidated sum for which the judgment has been given; (iii) is final; (iv) is not in respect of taxes, a fine or a penalty; (v) was not obtained by fraud; and (vi) is not of a kind the enforcement of which is contrary to natural justice or the public policy of the Cayman Islands. Subject to the above limitations, in appropriate circumstances, a Cayman Islands court may give effect in the Cayman Islands to other kinds of final foreign judgments such as declaratory orders, orders for performance of contracts and injunctions.

## ***Anti-Money Laundering—Cayman Islands***

In order to comply with legislation or regulations aimed at the prevention of money laundering, PubCo is required to adopt and maintain anti-money laundering procedures and may require subscribers to provide evidence to verify their identity and source of funds. Where permitted, and subject to certain conditions, PubCo may also delegate the maintenance of PubCo's anti-money laundering procedures (including the acquisition of due diligence information) to a suitable person.

PubCo reserves the right to request such information as is necessary to verify the identity of a subscriber. In some cases, the directors may be satisfied that no further information is required since an exemption applies under the Anti-Money Laundering Regulations (Revised) of the Cayman Islands, as amended and revised from time to time (the "**Regulations**"). Depending on the circumstances of each application, a detailed verification of identity might not be required where:

- the subscriber makes the payment for their investment from an account held in the subscriber's name at a recognized financial institution; or
- the subscriber is regulated by a recognized regulatory authority and is based or incorporated in, or formed under the law of, a recognized jurisdiction; or
- the application is made through an intermediary which is regulated by a recognized regulatory authority and is based in or incorporated in, or formed under the law of a recognized jurisdiction and an assurance is provided in relation to the procedures undertaken on the underlying investors.

For the purposes of these exceptions, recognition of a financial institution, regulatory authority, or jurisdiction will be determined in accordance with the Regulations by reference to those jurisdictions recognized by the Cayman Islands Monetary Authority as having equivalent anti-money laundering regulations.

In the event of delay or failure on the part of the subscriber in producing any information required for verification purposes, PubCo may refuse to accept the application, in which case any funds received will be returned without interest to the account from which they were originally debited.

PubCo also reserves the right to refuse to make any redemption payment to a shareholder if PubCo directors or officers suspect or are advised that the payment of redemption proceeds to such shareholder might result in a breach of applicable anti-money laundering or other laws or regulations by any person in any relevant jurisdiction, or if such refusal is considered necessary or appropriate to ensure our compliance with any such laws or regulations in any applicable jurisdiction.

If any person in the Cayman Islands knows or suspects or has reasonable grounds for knowing or suspecting that another person is engaged in criminal conduct or money laundering or is involved with terrorism or terrorist financing and property and the information for that knowledge or suspicion came to their attention in the course of business in the regulated sector, or other trade, profession, business or employment, the person will be required to report such knowledge or suspicion to (i) a nominated officer (appointed in accordance with the Proceeds of Crime Act (Revised) of the Cayman Islands) or the Financial Reporting Authority of the Cayman Islands, pursuant to the Proceeds of Crime Act (Revised), if the disclosure relates to criminal conduct or money laundering; or (ii) to a police constable or a nominated officer (pursuant to the Terrorism Act (Revised) of the Cayman Islands) or the Financial Reporting Authority, pursuant to the Terrorism Act (Revised), if the disclosure relates to involvement with terrorism or terrorist financing and property. Such a report shall not be treated as a breach of confidence or of any restriction upon the disclosure of information imposed by any enactment or otherwise.

## **Data Protection—Cayman Islands**

PubCo has certain duties under the Data Protection Act (As Revised) of the Cayman Islands and any regulations, codes of practice, or orders promulgated pursuant thereto (the “DPA”) based on internationally accepted principles of data privacy.

### **Privacy Notice**

#### ***Introduction***

This privacy notice puts PubCo’s shareholders on notice that through your investment in the Company you will provide us with certain personal information which constitutes personal data within the meaning of the DPA (“personal data”). In the following discussion, the “company” refers to us and PubCo’s affiliates and/or delegates, except where the context requires otherwise.

PubCo is committed to processing personal data in accordance with the DPA. In our use of personal data, PubCo will be characterized under the DPA as a “data controller,” whilst certain of PubCo’s service providers, affiliates, and delegates may act as “data processors” under the DPA. These service providers may process personal information for their own lawful purposes in connection with services provided to us.

#### ***How PubCo May Use a Shareholder’s Personal Data***

By virtue of your investment in PubCo, PubCo and certain of PubCo’s service providers may collect, record, store, transfer, and otherwise process personal data by which individuals may be directly or indirectly identified.

Your personal data will be processed fairly and for lawful purposes, including (a) where the processing is necessary for PubCo to perform a contract to which you are a party or for taking pre-contractual steps at your request, (b) where the processing is necessary for compliance with any legal, tax, or regulatory obligation to which PubCo is subject to, or (c) where the processing is for the purposes of legitimate interests pursued by PubCo or by a service provider to whom the data are disclosed. As a data controller, PubCo will only use your personal data for the purposes for which PubCo collected it. PubCo will contact you if PubCo needs to use your personal data for an unrelated purpose.

#### ***Why PubCo May Transfer Your Personal Data***

PubCo anticipates that PubCo will share your personal data with PubCo’s service providers for the purposes set out in this privacy notice. PubCo may also share relevant personal data where it is lawful to do so and necessary to comply with PubCo’s contractual obligations or your instructions or where it is necessary or desirable to do so in connection with any regulatory reporting obligations. In exceptional circumstances, PubCo will share your personal data with regulatory, prosecuting, and other governmental agencies or departments, and parties to litigation (whether pending or threatened), in any country or territory including to any other person where we have a public or legal duty to do so (e.g. to assist with detecting and preventing fraud, tax evasion, and financial crime or compliance with a court order).

Your personal data shall not be held by PubCo for longer than necessary with regard to the purposes of the data processing.

PubCo will not sell your personal data. Any transfer of personal data outside of the Cayman Islands shall be in accordance with the requirements of the DPA. Where necessary, PubCo will ensure that separate and appropriate legal agreements are put in place with the recipient of that data.

PubCo will only transfer personal data in accordance with the requirements of the DPA, and will apply appropriate technical and organizational information security measures designed to protect against unauthorized or unlawful processing of the personal data and against the accidental loss, destruction, or damage to the personal data.

### **Who this Affects**

If you are a natural person, this will affect you directly. If you are a corporate investor (including, for these purposes, legal arrangements such as trusts or exempted limited partnerships) that provides us with personal data on individuals connected to you for any reason in relation to your investment into the company, this will be relevant for those individuals and you should inform such individuals of the content of this privacy notice.

### **What Are Your Rights**

You have certain rights under the DPA, including (a) the right to be informed as to how PubCo collects and uses your personal data (and this privacy notice fulfils PubCo's obligation in this respect), (b) the right to obtain a copy of your personal data, (c) the right to require us to stop direct marketing, (d) the right to have inaccurate or incomplete personal data corrected, (e) the right to withdraw your consent and require us to stop processing or restrict the processing, or not begin the processing of your personal data, (f) the right to be notified of a data breach (unless the breach is unlikely to be prejudicial), (g) the right to obtain information as to any countries or territories outside the Cayman Islands to which PubCo, whether directly or indirectly, transfers, intends to transfer, or wishes to transfer your personal data, general measures PubCo takes to ensure the security of personal data, and any information available to us as to the source of your personal data, (h) the right to complain to the Office of the Ombudsman of the Cayman Islands, and (i) the right to require us to delete your personal data in some limited circumstances.

If you consider that your personal data has not been handled correctly, or you are not satisfied with PubCo's responses to any requests you have made regarding the use of your personal data, you have the right to complain to the Cayman Islands' Ombudsman. The Ombudsman can be contacted by calling +1 (345) 946-6283 or by email at [info@ombudsman.ky](mailto:info@ombudsman.ky).

### **Cayman Islands Economic Substance**

The Cayman Islands, together with several other non-European Union jurisdictions, have recently introduced legislation aimed at addressing concerns raised by the Council of the European Union as to offshore structures engaged in certain activities which attract profits without real economic activity. With effect from January 1, 2019, the International Tax Co-operation (Economic Substance) Act (Revised) (the "Substance Act") came into force in the Cayman Islands introducing certain economic substance requirements for in-scope Cayman Islands entities which are engaged in certain "relevant activities," which in the case of exempted companies incorporated before January 1, 2019, applies in respect of financial years commencing July 1, 2019, onwards. However, it is anticipated that our Company may remain out of scope of the legislation or else be subject to more limited substance requirements.

## COMPARISON OF CORPORATE GOVERNANCE AND SHAREHOLDER RIGHTS

This section describes the material differences between the rights of PNAC stockholders before the consummation of the Business Combination, and the rights of PubCo shareholders after the Business Combination. These differences in shareholder rights result from the differences between the respective governing documents of PNAC and PubCo.

This section does not include a complete description of all differences among such rights, nor does it include a complete description of such rights. Furthermore, the identification of some of the differences of these rights as material is not intended to indicate that other differences that may be equally important do not exist. PNAC stockholders are urged to carefully read the relevant provisions of the Amended PubCo Charter that will be in effect as of consummation of the Business Combination (which form is included as Annex B to this proxy statement/prospectus) to be compared against the Existing PNAC Charter. References in this section to the Amended PubCo Charter are references thereto as they will be in effect upon consummation of the Business Combination. However, the Amended PubCo Charter may be amended at any time prior to consummation of the Business Combination by mutual agreement of PNAC and noco-noco or after the consummation of the Business Combination by amendment by means of a special resolution of PubCo's shareholders and otherwise in accordance with their terms. If the Amended PubCo Charter are amended, the below summary may cease to accurately reflect the Amended PubCo Charter as so amended.



**Authorized Share Capital**

PNAC authorized share capital consists of (a) 20,100,000 shares of common stock (the "Common Stock"), including (i) 20,000,000 shares of Class A Common Stock (the "Class A Common Stock"), and (ii) 100,000 shares of Class B Common Stock (the "Class B Common Stock"), and (b) 400,000 shares of preferred stock (the "Preferred Stock"), each with a par value of \$0.0001 per share.

PubCo authorized share capital is \$50,000 divided into 500,000,000 PubCo Ordinary Shares of a par value of \$0.0001 each.

**Power to Issue Shares**

PNAC has a multi-class share structure comprising PNAC Class A Common Stock, PNAC Class B Common Stock and PNAC Preferred Stock.

PubCo has a single-class share structure comprising PubCo Ordinary Shares.

PNAC Board is hereby expressly authorized to provide out of the unissued shares of the Preferred Stock for one or more series of Preferred Stock and to establish from time to time the number of shares to be included in each such series and to fix the voting rights, if any, designations, powers, preferences and relative, participating, optional, special and other rights, if any, of each such series and any qualifications, limitations and restrictions thereof, as shall be stated in the resolution or resolutions adopted by the Board providing for the issuance of such series and included in a certificate of designation (a "Preferred Stock Designation") filed pursuant to the DGCL, and the Board is hereby expressly vested with the authority to the full extent provided by law, now or hereafter, to adopt any such resolution or resolutions.

Subject to the Amended PubCo Charter, all shares for the time being unissued shall be under the control of the PubCo's board of directors who may issue, allot and dispose of the same to such persons, in such manner, on such terms and having such rights and being subject to such restrictions as they may from time to time determine and grant options with respect to such shares and issue warrants or similar instruments with respect thereto, and for such purposes, the PubCo's board of directors may reserve an appropriate number of shares for the time being unissued.

**Number and Qualification of Directors**

The number of directors of the Corporation, other than those who may be elected by the holders of one or more series of the Preferred Stock voting separately by class or series, shall be fixed from time to time exclusively by the Board pursuant to a resolution adopted by a majority of the Board.

Subject to the Amended PubCo Charter, the PubCo's board of directors shall consist of no less than three and the maximum number of Directors shall be unlimited, but the PubCo can increase or reduce the limits on the number of Directors by Ordinary Resolution (as defined in the Amended PubCo Charter).

**Appointment/Removal of Directors**

Prior to the closing of a business combination, PNAC may appoint or remove any director by ordinary resolution of the holders of PNAC Class B Common Stock.

PubCo can appoint directors by Ordinary Resolution (as defined in the Amended PubCo Charter) or by the Directors. PubCo does not have a classified board. Unless re-appointed or removed pursuant to the Amended PubCo Charter, each Director of PubCo will be appointed for a term expiring at the next following annual general meeting of the PubCo.

In addition, the PNAC Board may appoint any person to be a director, either to fill a vacancy or as an additional director provided that the appointment does not cause the number of directors to exceed any number fixed by or in accordance with the PNAC amended and restated memorandum and articles of association as the maximum number of directors.

### Vacancies on the Board of Directors

The office of any director shall be vacated due to the director's death, resignation, retirement, disqualification or removal.

Other than retirement, the office of any director shall be terminated if:

- (a) he/she is prohibited by the law of the Cayman Islands from acting as a Director; or
- (b) he/she is made bankrupt or makes an arrangement or composition with his/her creditors generally; or
- (c) he/she resigns his/her office by notice to PubCo; or
- (d) he/she only held office as a Director for a fixed term and such term expires; or
- (e) in the opinion of a registered medical practitioner by whom he/she is being treated he/she becomes physically or mentally incapable of acting as a Director; or
- (f) the majority of the other Directors (being not less than two in number) determine that he/she should be removed as a Director, either by a resolution passed by the majority of the other Directors at a meeting of the Directors duly convened and held in accordance with the Amended PubCo Charter or by a resolution in writing signed by the majority of the other Directors; or
- (g) he/she is made subject to any law relating to mental health or incompetence, whether by court order or otherwise; or
- (h) without the consent of the other Directors, he/she is absent from meetings of Directors for a continuous period of six months.

### Amendment to Governing Documents

Pursuant to the Existing PNAC Charter, the Charter may be amended by a majority of the outstanding stock entitled to vote thereon, and a majority of the outstanding stock of each class entitled to vote thereon as a class has been voted in favor of the amendment, as set forth in Section 282 of the DGCL, *provided that* (i) amendment to Article IX requires a vote of 65% of the outstanding Class A and Class B Common Stock holders voting in favor; (ii) any amendment to Article IX will be voided, and Article IX will remain unchanged, if any stockholders who wish to redeem are unable to redeem due to the Redemption Limitation; (iii) amendment to Section 9.9 requires the vote of 90% of the outstanding Class A and Class B Common Stock holders voting in favor.

Pursuant to Cayman Islands Companies Act, the Amended PubCo Charter may only be amended by a special resolution of the shareholders.

### Quorum

Quorum is set forth in PNAC's By-Laws.

*Shareholders.* (a) if PubCo has only one shareholder: that shareholder; (b) if PubCo has more than one shareholder: one or more shareholder holding shares that represent not less than one-third of the outstanding shares carrying the right to vote at such General Meeting.

*Board of Directors.* The quorum necessary for the transaction of the business of the directors shall be any two directors, unless otherwise decided.

## Shareholder Meetings

Special meetings of stockholders of the Corporation may be called only by the Chairman of the Board, Chief Executive Officer of the Corporation, or the Board pursuant to a resolution adopted by a majority of the Board.

General meetings may be called only by:

- (a) PubCo directors; or
- (b) the shareholders in the circumstances below.

General meetings shall be convened on the requisition in writing of any shareholder or shareholders holding at least 10 percent of the rights to vote at such general meeting which requisition must also specify the purpose of the meeting, be signed by or on behalf of each requisitioner (and for this purpose each joint holder shall be obliged to sign), and be delivered in accordance with the notice provisions in the Amended PubCo Charter, and if the directors do not convene such meeting within 21 clear days' from the date of receipt of a requisition, the requisitioners or any of them may call a general meeting within three months after the end of that period.

## Notice of Shareholder Meetings

Advance notice of stockholder nominations for the election of directors and of business to be brought by stockholders before any meeting of the stockholders of the Corporation shall be given in the manner provided in the By-Laws.

At least twenty-one clear days' notice of an annual general meeting must be given to shareholders. For any other general meeting, at least fourteen clear days' notice must be given to shareholders.

Subject to the Cayman Islands Companies Act, a meeting may be convened on shorter notice, with the consent of the shareholder or shareholders who, individually or collectively, hold at least ninety per cent of the voting rights of all those who have a right to vote at that meeting

## Indemnification, liability insurance of Directors and Officers

To the fullest extent permitted by applicable law, as the same exists or may hereafter be amended, PNAC shall indemnify and hold harmless each person who is or was made a party or is threatened to be made a party to or is otherwise involved in any threatened, pending or completed action, suit or proceeding, whether civil, criminal, administrative or investigative (a "proceeding") by reason of the fact that he or she is or was a director or officer of PNAC or, while a director or officer of PNAC, is or was serving at the request of PNAC as a director, officer, employee or agent of another corporation or of a partnership, joint venture, trust, other enterprise or nonprofit entity, including service with respect to an employee benefit plan (an "indemnitee"), whether the basis of such proceeding is alleged action in an official capacity as a director, officer, employee or agent, or in any other capacity while serving as a director, officer, employee or agent, against all liability and loss suffered and expenses (including, without limitation, attorneys' fees, judgments, fines, ERISA excise taxes and penalties and amounts paid in settlement) reasonably incurred by such indemnitee in connection with such proceeding. PNAC shall to the fullest extent not prohibited by applicable law pay the expenses (including attorneys' fees) incurred by an indemnitee in defending or otherwise participating in any proceeding in advance of its final disposition; provided, however, that, to the extent required by applicable law, such payment of expenses in advance of the final disposition of the proceeding shall be made only upon receipt of an undertaking, by or on behalf of the indemnitee, to repay all amounts so advanced if it shall ultimately be determined that the indemnitee is not entitled to be indemnified under this Section.

Every PubCo existing or former director (including alternate director), secretary and other officer (including an investment adviser or an administrator or liquidator) and the personal representatives of the same (each an "Indemnified Person") shall be indemnified against all (a) all actions, proceedings, costs, charges, expenses, losses, damages or liabilities incurred or sustained by the existing or former director (including alternate director), secretary or officer in or about the conduct of the PubCo 's business or affairs or in the execution or discharge of the existing or former director (including alternate director), secretary or officer's duties, powers, authorities or discretions; and (b) without limitation to paragraph (a), all costs, expenses, losses or liabilities incurred by the existing or former director (including alternate director), secretary or officer in defending (whether successfully or otherwise) any civil, criminal, administrative or investigative proceedings (whether threatened, pending or completed) concerning PubCo or its affairs in any court or tribunal, whether in the Cayman Islands or elsewhere.

Such indemnity only applies if the Directors are of the view that, in the absence of fraud, willful default or willful neglect, an existing or former director (including alternate director), secretary or officer acted honestly and in good faith with a view to what the person believes is in the best interests of PubCo and, in the case of criminal proceedings, such person had no reasonable cause to believe that their conduct was unlawful. No such existing or former director (including alternate director), secretary or officer, however, shall be indemnified in respect of any matter arising out of his/her own actual fraud, willful default or willful neglect.

### **Dividends**

Subject to applicable law, the rights, if any, of the holders of any outstanding series of the Preferred Stock and the provisions of Article IX of Existing PNAC Charter, the holders of shares of Class A or Class B Common Stock shall be entitled to receive such dividends and other distributions (payable in cash, property or capital stock of PNAC) when, as and if declared thereon by the Board from time to time out of any assets or funds of the PNAC legally available therefor and shall share equally on a per share basis in such dividends and distribution.

Dividends may be declared and paid out of any funds of PubCo lawfully available for distribution. Subject to Cayman Islands Companies Act, dividends may also be declared and paid out of any share premium account.

Subject to the provisions of the Cayman Islands Companies Act, PubCo may by ordinary resolution declare dividends in accordance with the respective rights of the shareholders but no dividend shall exceed the amount recommended by the directors. If the directors so determine, any resolution declaring a dividend may direct that it shall be satisfied wholly or partly by the distribution of assets.

Unless provided for by the rights attached to a Share, no dividend or other monies payable by PubCo in respect of a share shall bear interest

### **Winding up**

Existing PNAC Charter provides that if PNAC does not consummate a Business Combination (as defined therein) within eighteen months after the consummation of PNAC's initial public offering (or such later time as the PNAC stockholders may approve in accordance with the Existing PNAC Charter), PNAC shall (i) cease all operations except for the purpose of winding up, (ii) as promptly as reasonably possible but not more than ten business days thereafter subject to lawfully available funds therefor, redeem 100% of the Offering Shares in consideration of a per-share price, payable in cash, equal to the quotient obtained by dividing (A) the aggregate amount then on deposit in the Trust Account, including interest (net of taxes payable, less up to \$50,000 of such net interest to pay dissolution expenses), by (B) the total number of then outstanding Offering Shares, which redemption will completely extinguish rights of the Public Stockholders (including the right to receive further liquidating distributions, if any), and (iii) as promptly as reasonably possible following such redemption, dissolve and liquidate.

In accordance with the Cayman Islands Companies Act and the Amended PubCo Charter, PubCo may be wound up voluntarily:

if the shareholders resolve by special resolution that it be wound up voluntarily.

### Supermajority Voting Provisions

A super-majority of no less than 65% vote is required to amend Article IX, which governs the use of funds and the distribution of the Trust Account, the maximum time allowed for PNAC to consummate its Business Combination, redemption of PNAC Common Stock, share issuance before Business Combination, transactions with affiliates or other special purpose acquisition company, and minimum value of Business Combination targets.

A super-majority of no less than 90% vote is required to amend Section 9.9, which provides for the exclusive right of holders of PNAC's Class B Common Stock to appoint and remove directors.

A special resolution, requiring not less than a two-thirds vote (including unanimous written resolution), is required to:

- (a) change PubCo's name;
- (b) amend the Amended PubCo Charter;
- (c) amend the Amended PubCo Charter with respect to any objects, powers or other matters;
- (d) reduce PubCo's share capital and any capital redemption reserve;
- (e) change PubCo's registration to a jurisdiction outside the Cayman Islands; and
- (f) merge or consolidate PubCo with one or more other constituent companies.

### SHARES ELIGIBLE FOR FUTURE SALE

Upon the consummation of the Business Combination, PubCo will have, based on the assumptions set out elsewhere in this proxy statement/prospectus, up to 141,584,716 PubCo Ordinary Shares issued and outstanding assuming no redemption by PNAC Public Stockholders. All of the PubCo Ordinary Shares (i) issued to the PNAC stockholders in connection with the Merger other than those issued to PNAC Initial Stockholders and (ii) issued to the Sellers in connection with the Share Exchange other than those issued to noco-noco's affiliates will be freely transferable by persons without restriction or further registration under the Securities Act. Sales of substantial amounts of the PubCo Ordinary Shares in the public market could adversely affect prevailing market prices of the PubCo Ordinary Shares. Prior to the Business Combination, there has been no public market for PubCo Ordinary Shares. PubCo has applied for listing of the PubCo Ordinary Shares on the Nasdaq, but there can be no assurance that a regular trading market will develop in the PubCo Ordinary Shares.

## Lock-up Agreements

Prior to the Merger Effective Time, the Sellers and the PNAC Initial Stockholders will enter into lock-up agreements with the PNAC and PubCo (the “Lock-up Agreement”). As a result of these lock-up provisions, additional securities of PubCo will be eligible for resale as follows.

Pursuant to the Lock-Up Agreement, PubCo Ordinary Shares held by such holders are categorized as (i) “Group I Lock-up Shares”, referring to the 50% of the total number of PubCo Ordinary Shares that such Seller will receive in connection with the Share Exchange, or 50% of the number of PubCo Ordinary Shares such Holder will receive in converting their PNAC Founder Shares in connection with the Merger, (ii) “Group II Lock-up Shares”, referring to the remaining 50% of the total number of PubCo Ordinary Shares that such Seller will receive in connection with the Share Exchange, or 50% of the number of PubCo Ordinary Shares such Holder will receive in converting its PNAC Founder Shares in connection with the Merger; and (iii) “Group III Lock-up Shares”, referring to the total number of PubCo Ordinary Shares that such Holder will receive in converting its PNAC Private Shares in connection with the Merger. The Group I Lock-Up Shares, Group-II Lock-up Shares, Group-III Lock-up Shares shall be collectively referred as “Lock-up Shares”.

The “Lock-up Period” means (i) with respect to the Group I Lock-up Shares, the period commencing on the Share Exchange Closing Date and ending on the date that is the earlier to occur of (A) six months thereafter, or (B) the date on which the closing price of each PubCo Ordinary Share equals or exceeds \$12.50 per share (as adjusted for share splits, share dividends, reorganizations and recapitalizations) for any 20 trading days within any 30-trading day period commencing after the completion of the Share Exchange; (ii) with respect to the Group II Lock-up Shares, the period commencing on the Share Exchange Closing Date and ending on the date that is six months thereafter; (iii) with respect to the Group III Lock-up Shares, the period commencing on the Share Exchange Closing Date and ending on the 30 days thereafter.

The holders will, subject to certain customary exceptions, agree not to, within the Lock-up Period, (i) sell, offer to sell, contract or agree to sell, pledge or otherwise dispose of, directly or indirectly, any Lock-up Shares, (ii) enter into a transaction that would have the same effect, (iii) enter into any swap, hedge or other arrangement that transfers to another, in whole or in part, any of the economic consequences of ownership of the Lock-Up Shares or otherwise or engage in any short sales or other arrangement with respect to the Lock-Up Shares or (iv) publicly announce any intention to effect any transaction specified in clause (i) or (ii).

## Registration Rights

Prior to the Share Exchange Closing, PubCo and certain holders of PubCo Ordinary Shares (including PNAC Initial Stockholders and the Sellers) will enter into the Registration Rights Agreement, to be effective upon the Closing pursuant to which, among other things, PubCo will agree to undertake certain resale shelf registration obligations in accordance with the Securities Act and the holders have been granted certain demand and piggyback registration rights.

As provided in the Registration Rights Agreement, PubCo must upon the demand of the registration rights holders, use reasonable efforts to cause to be declared effective as soon as practicable thereafter, a registration statement for a “shelf” registration on Form F-1 (“Form F-1 Shelf”) covering the resale of all registrable securities held by the holders of registration rights on a delayed or continuous basis. Following the filing of the Form F-1 Shelf, PubCo has agreed to use reasonable efforts to convert the Form F-1 Shelf to a shelf registration on Form F-3, and/or to file and cause to become effective a shelf registration on Form F-3, as soon as practicable and in any event after PubCo is eligible to use Form F-3. A majority-in-interest of the Demanding Holders (as defined in the Registration Rights Agreement), may, subject to certain limitations described in the Registration Rights Agreement, make demand for an underwritten offering of all or any portion of their registrable securities pursuant to the shelf, up to certain number of times depending on the type of registrable securities that such holder holds; provided that PubCo will not be required to effectuate (i) with respect to any Tranche A Registrable Securities (as defined in the Registration Rights Agreement), more than an aggregate of one (1) registration pursuant to a demand registration, (ii) with respect to any Tranche B Registrable Securities (as defined in the Registration Rights Agreement), more than an aggregate of one (1) registration pursuant to a demand registration, (iii) with respect to any Tranche C Registrable Securities (as defined in the Registration Rights Agreement), more than an aggregate of one (1) registration pursuant to a demand registration, and (iv) with respect to any Tranche D Registrable Securities (as defined in the Registration Rights Agreement), more than an aggregate of one (1) registration pursuant to a demand registration; provided, however, that a registration shall not be counted for such purposes unless a Form F-1 or any similar long-form registration statement that may be available at such time has become effective and all of the registrable securities requested by the requesting holders to be registered on behalf of the requesting holders in such Form F-1 registration have been sold, in accordance with the Registration Rights Agreement. In addition, holders of registrable securities have certain “piggy-back” registration rights with respect to registration statements filed after the expiration of any lock-up to which such securities are subject pursuant to any Lock-Up Agreement, with certain customary exceptions. PubCo will bear all costs and expenses incurred in connection with the filing of any such registration statements.

## Rule 144

Pursuant to Rule 144 under the Securities Act (“Rule 144”), a person who has beneficially owned restricted PubCo Ordinary Shares or PubCo Warrants for at least six months would be entitled to sell their securities; provided that (i) such person is not deemed to have been one of PubCo’s affiliates at the time of, or at any time during the three months preceding, a sale and (ii) PubCo is subject to the Exchange Act periodic reporting requirements for at least three months before the sale and has filed all required reports under Section 13 or 15(d) of the Exchange Act during the 12 months (or such shorter period as it was required to file reports) preceding the sale.

Persons who have beneficially owned restricted PubCo Ordinary Shares or PubCo Warrants for at least six months but who are PubCo’s affiliates at the time of, or at any time during the three months preceding, a sale, would be subject to additional restrictions, by which such person would be entitled to sell within any three-month period only a number of securities that does not exceed the greater of:

- one percent (1%) of the total number of PubCo Ordinary Shares then issued and outstanding; or
- the average weekly reported trading volume of the PubCo Ordinary Shares during the four calendar weeks preceding the filing of a notice on Form 144 with respect to the sale.

Sales by PubCo’s affiliates under Rule 144 are also limited by manner of sale provisions and notice requirements and to the availability of current public information about PubCo.

### ***Restrictions on the Use of Rule 144 by Shell Companies or Former Shell Companies***

Rule 144 is not available for the resale of securities initially issued by shell companies (other than business combination related shell companies) or issuers that have been at any time previously a shell company. However, Rule 144 also includes an important exception to this prohibition if the following conditions are met:

- the issuer of the securities that was formerly a shell company has ceased to be a shell company;
- the issuer of the securities is subject to the reporting requirements of Section 13 or 15(d) of the Exchange Act;
- the issuer of the securities has filed all Exchange Act reports and material required to be filed, as applicable, during the preceding 12 months (or such shorter period that the issuer was required to file such reports and materials); and
- at least one year has elapsed from the time that the issuer filed Form 20-F type information with the SEC, which is expected to be filed promptly after consummation of the Business Combination, reflecting its status as an entity that is not a shell company.



## PRICE RANGE OF SECURITIES AND DIVIDEND INFORMATION

PNAC Units, PNAC Public Shares, PNAC Warrants, and PNAC Rights are separately listed in the Nasdaq Global Market under the symbols “PNACU”, “PNAC”, “PNACW”, and “PNACR”, respectively.

The closing price of the PNAC Class A Common Stock on [ ], the last trading day before announcement of the execution of the Business Combination Agreement, was \$10.15. As of [ ], 2023, the Record Date for the Special Meeting, the most recent closing price for each PNAC Class A Common Stock was \$ [ ] .

PNAC holders should obtain current market quotations for their securities. The market price of PNAC’s securities could vary at any time before the Business Combination.

Historical market price information regarding noco-noco is not provided because there is no public market for their securities.

Historical market price information regarding PubCo is not provided because there is no public market for its securities. PubCo has applied to list the PubCo Ordinary Shares on the Nasdaq [ ] Market under the symbol “ [ ] ”. It is a condition to consummation of the Business Combination in the Business Combination Agreement that the PubCo Ordinary Shares to be issued in connection with the Business Combination shall have been approved for listing on the Nasdaq, subject only to official notice of issuance thereof. PubCo, noco-noco and PNAC have certain obligations in the Business Combination Agreement to use reasonable best efforts in connection with the Business Combination, including with respect to satisfying this Nasdaq listing condition. The Nasdaq listing condition in the Business Combination Agreement may be waived by the parties to the Business Combination Agreement.

### Holders

As of [ ] the Record Date, there were [ ] holders of record of PNAC Units, [ ] holder of record of PNAC Common Stock, [ ] holders of record of PNAC Warrants, and [ ] holders of record of PNAC Rights. As of [ ] the Record Date, there were [ ] holders of record of noco-noco Shares. As of [ ] the Record Date, PubCo had one holder of record. See “*Security Ownership of Certain Beneficial Owners and Management.*”

### Dividend Policy

PNAC has not paid any cash dividends on PNAC Common Stock to date and does not intend to pay cash dividends prior to the completion of the Business Combination. In addition, noco-noco has not paid any dividends to its shareholders. The payment of any cash dividends after consummation of the Business Combination shall be dependent upon the revenue, earnings and financial condition of PubCo from time to time. The payment of any dividends subsequent to the Business Combination shall be within the discretion of the board of directors of PubCo.

## ANNUAL MEETING SHAREHOLDER PROPOSALS

If the Business Combination is consummated, you shall be entitled to attend and participate in PubCo’s annual meetings of shareholders. If PubCo holds a 2023 annual meeting of shareholders, it shall provide notice of or otherwise publicly disclose the date on which the 2023 annual meeting shall be held. As a foreign private issuer, PubCo will not be subject to the SEC’s proxy rules.

## OTHER SHAREHOLDER COMMUNICATIONS

Shareholders and interested parties may communicate with PNAC’s board of directors, any committee chairperson or the non-management directors as a group by writing to the board or committee chairperson in care of PNAC, at c/o 1129 Northern Blvd., Suite 404, Manhasset, New York 11030, United States. Following the Business Combination, such communications should be sent in care of PubCo, at 4 Shenton Way, #04-06 SGX Centre II, Singapore 068807. Each communication shall be forwarded, depending on the subject matter, to the board of directors, the appropriate committee chairperson or all non-management directors.

## ENFORCEABILITY OF CIVIL LIABILITIES

### *Service of Process*

PubCo is incorporated under the laws of the Cayman Islands as an exempted company with limited liability. PubCo was incorporated in the Cayman Islands in order to enjoy the following benefits:

- political and economic stability;
- an effective judicial system;
- a favorable tax system;
- the absence of exchange control or currency restrictions; and
- the availability of professional and support services.

However, certain disadvantages accompany incorporation in the Cayman Islands. These disadvantages include:

- the Cayman Islands has a less exhaustive body of securities laws as compared to the United States and these securities laws provide significantly less protection to investors; and
- Cayman Islands companies may not have standing to sue before the federal courts of the United States.

The PubCo's memorandum and articles of association do not contain provisions requiring that disputes, including those arising under the securities laws of the United States, between PubCo, PubCo's officers, directors and shareholders, be arbitrated.

All of the directors and executive officers of PubCo, and certain of the experts named in this proxy statement/prospectus are residents of non-United States jurisdictions and all or a substantial portion of the assets of such persons are located outside the United States. As a result, it may not be possible for investors to effect service of process within the United States upon such persons with respect to matters arising under the Securities Act or to enforce against them, in original actions or in actions for enforcement of judgments of United States courts, liabilities predicated upon the United States federal securities laws.

PubCo will appoint [●] as its agent upon whom process may be served in any action brought against it under the securities laws of the United States after the consummation of the Business Transactions.

### *Enforcement of Civil Liabilities in Cayman Islands*

PubCo has been advised by its Cayman Islands legal counsel, Ogier, that there is uncertainty as to whether courts of the Cayman Islands would (i) recognize or enforce judgement of courts of the United States against PubCo or PubCo's directors or officers predicated upon the civil liability provisions of the securities laws of the United States or any state in the United States; or (ii) entertain original actions brought in each respective jurisdiction against PubCo or PubCo's directors or officers predicated upon the securities laws of the United States or any state in the United States. Ogier has informed PubCo that there is no statutory enforcement in the Cayman Islands of judgments obtained in the United States, the courts of the Cayman Islands will in certain circumstances recognize and enforce a foreign judgment, without any re-examination or re-litigation of matters adjudicated upon, provided such judgment: (a) is given by a foreign court of competent jurisdiction; (b) imposes on the judgment debtor a liability to pay a liquidated sum for which the judgment has been given; (c) is final; (d) is not be in respect of taxes or a fine or penalty, (e) was not obtained by fraud; and (f) is not of a kind the enforcement of which is, contrary to natural justice or the public policy of the Cayman Islands.

### *Enforcement of Civil Liabilities in Singapore*

noco-noco is incorporated in Singapore. It is possible that the courts in Singapore may not (i) recognize and enforce judgments of courts in the United States, based upon the civil liability provisions of the securities laws of the United States or any state or territory of the United States or (ii) enter judgments in original actions brought in the Singapore courts based solely on the civil liability provisions of these securities laws. An in personam final and conclusive judgment in the federal or state courts of the United States under which a fixed or ascertainable sum of money is payable may generally be enforced as a debt in the Singapore courts under the common law as long as it is established that the Singapore courts have jurisdiction over the judgment debtor. Additionally, the court where the judgment was obtained must have had international jurisdiction over the party sought to be bound in the local proceedings. However, the Singapore courts are unlikely to enforce a foreign judgment if, amongst others, (a) the foreign judgment is inconsistent with a prior local judgment on the same subject matter that is binding on the same parties; (b) the enforcement of the foreign judgment would contravene the public policy of Singapore; (c) the proceedings in which the foreign judgment was obtained were contrary to principles of natural justice; (d) the foreign judgment was obtained by fraud; or (e) the enforcement of the foreign judgment amounts to the direct or indirect enforcement of a foreign penal, revenue or other public law.

In particular, the Singapore courts may potentially not allow the enforcement of any foreign judgment for a sum payable in respect of taxes, fines, penalties or other similar charges, including the judgments of courts in the United States based upon the civil liability provisions of the securities laws of the United States or any state or territory of the United States. In respect of civil liability provisions of the United States federal and state securities law which permit punitive damages against us and our directors or executive officers, we are unaware of any decision by the Singapore courts which has considered the specific issue of whether a judgment of a United States court based on such civil liability provisions of the securities laws of the United States or any state or territory of the United States is enforceable in Singapore.

### *Enforcement of Civil Liabilities in PRC*

Some of PNAC's directors and officers, and some of the members and affiliates of PNAC's Sponsors are citizens or residents of PRC. There is uncertainty as to whether the courts of the PRC would recognize or enforce judgments of U.S. courts obtained against such individuals or entities affiliated with PNAC or the Sponsors that are predicated upon the civil liability provisions of the federal securities laws of the United States or the securities laws of any state in the United States, and entertain original actions brought in the PRC against PNAC, the Sponsors or such individuals or entities that are predicated upon the federal securities laws of the United States or the securities laws of any state in the United States.

The recognition and enforcement of foreign judgments are provided for under the PRC Civil Procedure Law. PRC courts may recognize and enforce foreign judgments under certain circumstances in accordance with the requirements of the PRC Civil Procedure Law. In addition, under PRC law, a foreign judgment that does not otherwise violate basic legal principles, state sovereignty, safety or social public interest of the PRC may be recognized and enforced by a PRC court, based either on bilateral treaties or international conventions contracted by China and the country where the judgment is made or on reciprocity between jurisdictions. As there currently exists no bilateral treaty, international convention or other form of reciprocity between China and the United States governing the recognition of judgments, including those predicated upon the liability provisions of the U.S. federal securities laws, it is uncertain whether a PRC court would enforce a judgment rendered by a court in the U.S.

Under the PRC Civil Procedures Law, foreign shareholders may originate actions based on PRC law against PNAC, the Sponsors or such individuals or entities affiliated with PNAC or the Sponsors in the PRC, if they can establish sufficient nexus to the PRC for a PRC court to have jurisdiction, and meet other procedural requirements, including, among others, the plaintiff must have a direct interest in the case, and there must be a concrete claim, a factual basis and a cause for the suit. However, it will be difficult for foreign shareholders to establish sufficient nexus to the PRC by virtue only of being PNAC Stockholders or PubCo Shareholders.

### *Enforcement of Civil Liabilities in Hong Kong*

In addition, PNAC's CEO and Chairman and certain members or affiliates of the PNAC's Sponsors are citizens or residents of Hong Kong. Foreign judgments of United States courts will not be directly enforced in Hong Kong as there are currently no treaties or other arrangements providing for reciprocal enforcement of foreign judgments between Hong Kong and the United States. However, the common law permits an action to be brought upon a foreign judgment. That is to say, a foreign judgment itself may form the basis of a cause of action since the judgment may be regarded as creating a debt between the parties to it. In a common law action for enforcement of a foreign judgment in Hong Kong, the enforcement is subject to various conditions, including but not limited to, the judgment is for a definite sum of money in a civil matter and not in respect of taxes, fines, penalties, or similar charges, the judgment is a final and conclusive and has not been stayed or satisfied in full, the judgment is from a competent court, the judgment was not obtained by fraud, misrepresentation or mistake nor obtained in proceedings which contravenes the rules of natural justice and the enforcement of the judgment is not contrary to public policy in Hong Kong, Hong Kong courts may accept such judgment obtained from a United States court as a debt due under the rules of common law. However, a separate legal action for debt must be commenced in Hong Kong in order to recover such debt from the judgment debtor.

## **LEGAL MATTERS**

noco-noco is being represented by Sidley Austin with respect to certain legal matters as to United States federal securities and New York State law. PNAC is being represented by Robinson & Cole LLP with respect to certain legal matters as to United States federal securities and New York State law, and is being represented by Messina Madrid Law PA with respect to certain United States tax law matters.

The validity of PubCo Ordinary Shares has been passed on by Ogier.

## **EXPERTS**

The financial statements for PNAC as of December 31, 2022 and for the period from February 25, 2021 (inception) through December 31, 2021, appearing in this proxy statement/prospectus have been audited by UHY LLP, an independent registered public accounting firm, as set forth in their report thereon appearing elsewhere in this proxy statement/prospectus, and are included in reliance on such report given on the authority of such firm as an expert in accounting and auditing. The registered address of UHY LLP is 1185 Ave of the Americas, 38th Floor, New York, NY 10036, United States.

The financial statements of NOCO-NOCO PTE. LTD. as of June 30, 2022 and 2021, and for the years ended June 30, 2022 and 2021, included in this proxy statement/prospectus have been so included in reliance on the report of Marcum Asia CPAs LLP, an independent registered public accounting firm, given on the authority of said firm as experts in auditing and accounting. The registered address of Marcum Asia CPAs LLP is 7 Penn Plaza, Suite 830, New York, NY 10001.

## **DELIVERY OF DOCUMENTS TO SHAREHOLDERS**

Pursuant to the rules of the SEC, PNAC and services that it employs to deliver communications to its shareholders are permitted to deliver to two or more shareholders sharing the same address a single copy of each of PNAC's annual report to shareholders and PNAC's proxy statement. Upon written or oral request, PNAC shall deliver a separate copy of the annual report to shareholder and/or proxy statement to any shareholder at a shared address to which a single copy of each document was delivered and who wishes to receive separate copies of such documents. Shareholders receiving multiple copies of such documents may likewise request that PNAC deliver single copies of such documents in the future. Shareholders receiving multiple copies of such documents may request that PNAC deliver single copies of such documents in the future. Shareholders may notify PNAC of their requests by writing PNAC at its principal executive offices at c/o 1129 Northern Blvd, Suite 404, Manhasset, NY 11030, United States. Following the Business Combination, such requests should be made by writing PubCo at its principal executive office at 4 Shenton Way, #04-06 SGX Centre II, Singapore 068807.

## WHERE YOU CAN FIND MORE INFORMATION

As a foreign private issuer, after the consummation of the Business Combination, PubCo shall be required to file its annual report on Form 20-F with the SEC no later than four months following its fiscal year end. PNAC files reports, proxy statements and other information with the SEC as required by the Exchange Act. You may access information on PNAC at the SEC web site containing reports, proxy statements and other information at: <http://www.sec.gov>.

Information and statements contained in this proxy statement/prospectus or any annex to this proxy statement/prospectus are qualified in all respects by reference to the copy of the relevant contract or other annex filed as an exhibit to this proxy statement/prospectus.

All information contained in this document relating to PNAC has been supplied by PNAC, and all such information relating to noco-noco has been supplied by noco-noco. Information provided by one entity does not constitute any representation, estimate or projection of the other entity.

noco-noco does not file any annual, quarterly or current reports, proxy statements or other information with the SEC.

**If you would like additional copies of this document or if you have questions about the Business Combination, you should contact via phone or in writing PNAC's proxy solicitation agent at the following address, telephone number and email:**

[Address & contact information to be added]

If you are a PNAC stockholder and would like to request documents, please do so by \_\_\_\_\_, 2023 to receive them before the PNAC Special Meeting of shareholders. If you request any documents from us, we shall mail them to you by first class mail, or another equally prompt means.

None of PNAC, PubCo or noco-noco has authorized anyone to give any information or make any representation about the Business Combination or their companies that is different from, or in addition to, that which is contained in this proxy statement/prospectus or in any of the materials that have been incorporated in this proxy statement/prospectus. Therefore, if anyone does give you information of this sort, you should not rely on it. If you are in a jurisdiction where offers to exchange or sell, or solicitations of offers to exchange or purchase, the securities offered by this proxy statement/prospectus or the solicitation of proxies is unlawful, or if you are a person to whom it is unlawful to direct these types of activities, then the offer presented in this proxy statement/prospectus does not extend to you.

The information contained in this proxy statement/prospectus speaks only as of the date of this proxy statement/prospectus unless the information specifically indicates that another date applies.

## INDEX OF FINANCIAL STATEMENTS

	<b>Page</b>
<b>Unaudited Interim Financial Statements of noco-noco Pte. Ltd.</b>	
<a href="#">Unaudited Condensed Balance Sheets</a>	<a href="#">F-2</a>
<a href="#">Unaudited Condensed Statements of Operations</a>	<a href="#">F-3</a>
<a href="#">Unaudited Condensed Statements of Changes in Shareholders' Equity (Deficit)</a>	<a href="#">F-4</a>
<a href="#">Unaudited Condensed Statements of Cash Flows</a>	<a href="#">F-5</a>
<a href="#">Notes to Unaudited Condensed Financial Statements</a>	<a href="#">F-6</a>
<b>Audited Financial Statements of noco-noco Pte. Ltd.</b>	
<a href="#">Report of Independent Registered Public Accounting Firm</a>	<a href="#">F-14</a>
<a href="#">Balance Sheets as of June 30, 2022 and 2021</a>	<a href="#">F-15</a>
<a href="#">Statements of Operations and Comprehensive Loss for the Fiscal Years Ended June 30, 2022 and 2021</a>	<a href="#">F-16</a>
<a href="#">Statements of Changes in Shareholders' Equity (Deficit) as of June 30, 2022 and 2021</a>	<a href="#">F-17</a>
<a href="#">Statements of Cash Flows for the Fiscal Year Ended June 30, 22 and 2021</a>	<a href="#">F-18</a>
<a href="#">Notes to the Financial Statements</a>	<a href="#">F-19</a>
<b>Unaudited Interim Financial Statements of Prime Number Acquisition I Corp.</b>	
<a href="#">Unaudited Condensed Balance Sheets</a>	<a href="#">F-27</a>
<a href="#">Unaudited Condensed Statements of Operations</a>	<a href="#">F-28</a>
<a href="#">Unaudited Condensed Statements of Changes in Shareholders' Equity (Deficit)</a>	<a href="#">F-29</a>
<a href="#">Unaudited Condensed Statements of Cash Flows</a>	<a href="#">F-30</a>
<a href="#">Notes to Unaudited Condensed Financial Statements</a>	<a href="#">F-31</a>
<b>Audited Financial Statements of Prime Number Acquisition I Corp.</b>	
<a href="#">Report of Independent Registered Public Accounting Firm (Firm ID: 1195)</a>	<a href="#">F-44</a>
Financial Statements:	
<a href="#">Balance Sheets</a>	<a href="#">F-45</a>
<a href="#">Statements of Operations</a>	<a href="#">F-46</a>
<a href="#">Statements of Changes in Stockholders' Equity (Deficit)</a>	<a href="#">F-47</a>
<a href="#">Statements of Cash Flows</a>	<a href="#">F-49</a>
<a href="#">Notes to Financial Statements</a>	<a href="#">F-50</a>

**NOCO-NOCO PTE. LTD**  
**UNAUDITED CONDENSED BALANCE SHEETS**  
(Amounts expressed in US dollars (“\$”) except for numbers of shares)

	As of	
	December 31, 2022	June 30, 2022
<b>ASSETS</b>		
<b>Current assets</b>		
Cash and cash equivalents	\$ 214,449	\$ 81,626
Deposit, upfront payments and other receivables	302,626	102,263
<b>Total current assets</b>	<b>517,075</b>	<b>183,889</b>
<b>Non-current assets</b>		
Property and equipment, net	14,594	10,607
Right of use assets – operating lease, net	305,829	44,925
<b>Total assets</b>	<b>\$ 837,498</b>	<b>\$ 239,421</b>
<b>Liabilities and Shareholders' (Deficit)</b>		
<b>Current liabilities</b>		
Accruals and other payables	\$ 27,266	\$ 13,227
Amount due to immediate holding company	1,681,003	974,632
Operating lease liability – current	169,334	36,385
<b>Total current liabilities</b>	<b>1,877,603</b>	<b>1,024,244</b>
<b>Non-current liabilities</b>		
Operating lease liability – non-current	124,918	-
<b>Total liabilities</b>	<b>\$ 2,002,521</b>	<b>\$ 1,024,244</b>
<b>Shareholders' deficit</b>		
Ordinary stock (unlimited shares authorized, no par value, 312,319 and 311,560 shares issued and outstanding as of December 31, 2022 and June 30, 2022, respectively)	\$ 2,348,091	\$ 1,557,804
Accumulated deficit	(3,506,394)	(2,351,743)
Accumulated other comprehensive income (loss)	(6,720)	9,116
<b>Total shareholders' deficit</b>	<b>\$ (1,165,023)</b>	<b>\$ (784,823)</b>
<b>Total liabilities and shareholder's deficit</b>	<b>\$ 837,498</b>	<b>\$ 239,421</b>

The accompanying notes are an integral part of these financial statements.

**NOCO-NOCO PTE. LTD**  
**UNAUDITED CONDENSED STATEMENTS OF OPERATIONS AND COMPREHENSIVE LOSS**

	<b>For the six months ended December 31,</b>	
	<b>2022</b>	<b>2021</b>
<b>Operating expenses:</b>		
Selling, general and administrative expenses	\$ 1,189,696	\$ 611,193
<b>Total operating expenses</b>	<b>1,189,696</b>	<b>611,193</b>
<b>Loss from operations</b>	<b>(1,189,696)</b>	<b>(611,193)</b>
<b>Other income/(expense):</b>		
Other income	26,987	8,365
Other expense	(257)	-
Foreign exchange gain	8,315	-
<b>Total other income</b>	<b>35,045</b>	<b>8,365</b>
<b>Net loss</b>	<b>(1,154,651)</b>	<b>(602,828)</b>
<b>Other comprehensive (loss)/income:</b>		
Foreign currency translation adjustment	(15,836)	(28,714)
<b>Comprehensive loss</b>	<b>(1,170,487)</b>	<b>(631,542)</b>
Basic and diluted loss per ordinary share	\$ (3.75)	\$ (10.29)
Basic and diluted weighted average number of ordinary shares outstanding	<b>311,905</b>	<b>61,368</b>

The accompanying notes are integral to these financial statements.

**NOCO-NOCO PTE. LTD**  
**UNAUDITED CONDENSED STATEMENTS OF CHANGES IN SHAREHOLDERS' EQUITY (DEFICIT)**

	Ordinary shares		Accumulated Other Comprehensive Income (Loss)	Accumulated Deficit	Total
	Number of shares	Amount			
<b>Balance as of June 30, 2021</b>	<b>2,000</b>	<b>\$ 10,000</b>	<b>\$ 23,259</b>	<b>\$ (1,274,920)</b>	<b>\$ (1,241,661)</b>
Ordinary shares issued for conversion of debt	309,560	1,547,804	-	-	1,547,804
Foreign currency translation adjustment	-	-	(28,714)	-	(28,714)
Net loss	-	-	-	(602,828)	(602,828)
<b>Balance as of December 31, 2021</b>	<b>311,560</b>	<b>\$ 1,557,804</b>	<b>\$ (5,455)</b>	<b>\$ (1,877,748)</b>	<b>\$ (325,399)</b>
<b>Balance as of June 30, 2022</b>	<b>311,560</b>	<b>\$ 1,557,804</b>	<b>\$ 9,116</b>	<b>\$ (2,351,743)</b>	<b>\$ (784,823)</b>
Ordinary shares issued for conversion of debt	759	790,287	-	-	790,287
Foreign currency translation adjustment	-	-	(15,836)	-	(15,836)
Net loss	-	-	-	(1,154,650)	(1,154,650)
<b>Balance as of December 31, 2022</b>	<b>312,319</b>	<b>\$ 2,348,091</b>	<b>\$ (6,720)</b>	<b>\$ (3,506,393)</b>	<b>\$ (1,165,022)</b>

The accompanying notes are integral to these financial statements.



**NOCO-NOCO PTE. LTD**  
**UNAUDITED CONDENSED STATEMENTS OF CASH FLOWS**

	<b>For the six months ended December 31,</b>	
	<b>2022</b>	<b>2021</b>
<b>Cash flows from operating activities</b>		
Net loss	\$ (1,154,650)	\$ (602,828)
Adjustments for reconcile net loss to net cash used in operating activities:		
Depreciation	2,222	1,685
Loss on disposal of property and equipment	257	-
Changes in operating assets and liabilities:		
Inventories	-	163,259
Deposit, upfront payments and other receivables	(200,363)	(21,090)
Accruals and other payables	14,039	173,137
Operating lease liabilities	(3,037)	1,038
<b>Net cash used in operations</b>	<b>(1,341,532)</b>	<b>(284,799)</b>
<b>Cash flows from investing activities</b>		
Purchase of property and equipment	(5,735)	(1,229)
<b>Cash used in investing activities</b>	<b>(5,735)</b>	<b>(1,229)</b>
<b>Cash flows from financing activities</b>		
Proceeds from immediate holding company	1,496,657	398,222
<b>Cash generated from financing activities</b>	<b>1,496,657</b>	<b>398,222</b>
Increase in cash and cash equivalents	149,390	112,193
Effect of exchange rate changes	(16,567)	(28,961)
Cash and cash equivalents at beginning of period	81,626	31,690
Cash and cash equivalents at end of period	<u>\$ 214,449</u>	<u>\$ 114,922</u>
<b>Supplemental cash flow information:</b>		
<b>Cash paid during the period for:</b>		
<b>Supplemental disclosure of non-cash investing and financing information:</b>		
Issuance of ordinary shares for conversion of debt	<u>\$ 790,287</u>	<u>\$ 1,547,804</u>

The accompanying footnotes are an integral part of these financial statements.

**NOCO-NOCO PTE. LTD.**  
**NOTES TO THE UNAUDITED CONDENSED FINANCIAL STATEMENTS**  
**FOR THE SIX MONTHS ENDED DECEMBER 31, 2022**  
**(Amounts expressed in US dollars (“\$”) except for numbers of shares)**

**NOTE 1 – ORGANIZATION AND NATURE OF OPERATIONS**

The Company incorporated as a Singapore corporation on July 25, 2019 under the name 3DOM (Singapore) Pte. Ltd. The Company is wholly owned by 3DOM Alliance Inc., a Company incorporated in Japan and the ultimate controlling shareholder is Mr. Masataka Matsumara.

On November 9, 2022, the Company changed its name from 3DOM (Singapore) Pte. Ltd. to noco-noco Pte. Ltd.

noco-noco Pte. Ltd. (“we”, “our”, “us” or collectively known as the “Company”) is a platform-solution provider of decarbonization offerings, aiming to truly solve urgent environmental crises through the comprehensive decarbonization of all forms of transportation.

**NOTE 2 - LIQUIDITY**

As of December 31, 2022 and June 2022, the Company had an accumulated deficit of \$3,506,393 and \$2,351,743 respectively. The Company incurred net loss of \$1,154,650 and \$602,828 for the six months ended December 31, 2022 and 2021, respectively. The cash used in operating activities for the six months ended December 31, 2022 and 2021, was \$1,341,532 and \$284,800, respectively.

The Company’s liquidity is based on its ability to generate cash from operating activities, obtain capital financing from equity interest investors and borrow funds on favorable economic terms to fund its general operations and capital expansion needs. The Company’s ability to continue as a going concern is dependent on management’s ability to successfully execute its business plan, which includes increasing revenue while controlling operating cost and expenses to generate positive operating cash flows and obtaining funds from outside sources of financing to generate positive financing cash flows. As of December 31, 2022, the Company’s balance of cash and cash equivalents was \$214,449. In addition, up to February 6, 2023, the immediate holding Company, 3DOM Alliance Inc, has extended the Promissory Note for the Company with a principal amount up to \$6,022,258 (\$8,000,000) and the Company has received financing of \$2,243,291 (\$2,980,000) from 3DOM Alliance Inc. Moreover, 3DOM Alliance Inc will not demand for payment on the amounts owing by the Company for at least the next twelve months from the issuance of the financial statements.

Based on cash flows projection from operating and financing activities and existing balance of cash and cash equivalents, management is of the opinion that the Company has sufficient funds for sustainable operations and it will be able to meet its payment obligations from operations and debt related commitments for the next twelve months from the issuance of the financial statements. Moreover, the management can adjust the pace of its operation expansion and control the operating expenses of the Company. Based on the above considerations, the Company’s financial statements have been prepared on a going concern basis, which contemplates the realization of assets and liquidation of liabilities during the normal course of operations.

**NOTE 3 - SUMMARY OF SIGNIFICANT ACCOUNTING POLICIES**

**Basis of Presentation**

Our financial statements have been prepared in conformity with U.S. generally accepted accounting principles (“GAAP”) in U.S. dollars. We have made all the adjustments that we believe are necessary for a fair presentation of our financial statements.

**Use of estimates**

The preparation of the financial statements in conformity with US GAAP requires management of the Company to make a number of estimates and assumptions relating to the reported amounts of assets and liabilities and the disclosure of contingent assets and liabilities at the date of the financial statements and the reported amounts of revenues and expenses during the reporting period. On an on-going basis we review our estimates and assumptions. The estimates were based on historical experience and other assumptions that we believe to be reasonable under the circumstances. Actual results could differ from those estimates under different assumptions or conditions, but we do not believe such differences will materially affect our financial position or results of operations

**Fiscal Year End**

The Company operates on a fiscal year basis with the fiscal year ending on June 30.

**Cash and Cash Equivalents**

Cash and cash equivalents consist of cash on hand and demand deposit with banks, which are unrestricted as to withdrawal and use, and which have original maturities of three months or less when purchased.

**Deposit, upfront payments and other receivables**

Security deposits paid for office lease are accounted for as deposit. Amounts paid in advance for future expenses are accounted for as prepaid expenses. Goods and Service Tax ("GST") refunds and collection of proceed from sales of batteries to business partner are accounted for as other receivables.

**Property and equipment**

Property and equipment are stated at cost, less accumulated depreciation. Expenditures for additions, major renewals and betterments are capitalized and expenditures for maintenance and repairs are charged to expense as incurred.

Depreciation is computed using the straight-line method over the estimated useful lives of the related capitalized assets. The estimated useful lives are as follows:

	<u>Useful lives</u>
Office equipment	5 years

**Other current liabilities**

Other current liabilities are liabilities for goods and services provided to the Company prior to the end of the financial year which are unpaid. They are classified as current liabilities if payment is due within one year or less. If not, they are presented as non-current liabilities.

**Leases**

We have entered into operating lease agreements primarily for office. We determine if an arrangement is a lease at inception. For all classes of underlying assets, we elect not to recognize right of use assets or lease liabilities when a lease has a lease term of 12 months or less at the commencement date and does not include an option to purchase the underlying asset that we are reasonably certain to exercise. Operating lease assets and liabilities are included on our balance sheet as of December 31, 2022 and June 30, 2022.

Operating lease assets and liabilities are recognized at the present value of the future lease payments at the lease commencement date. The interest rate used to determine the present value of the future lease payments is our incremental borrowing rate, because the interest rate implicit in most of our leases is not readily determinable. Our incremental borrowing rate is estimated to approximate the interest rate on a collateralized basis with similar terms and payments, and in economic environments where the leased asset is located. Operating lease assets also include any prepaid lease payments and lease incentives. Our lease terms include periods under options to extend or terminate the lease when it is reasonably certain that we will exercise that option. We generally use the base, non-cancellable, lease term when determining the lease assets and liabilities. Operating lease expense is recognized on a straight-line basis over the lease term.

### **Share Split**

On April 27, 2022, our Board of Directors declared a one-for-twenty shares split of our ordinary shares (“Share Split”). There was no net effect on the total stockholders' equity, and the par value per share of our ordinary shares remains unchanged at \$-0- per share after the Share Split. All references made to share or per share amounts in the accompanying financial statements and applicable disclosures have been retroactively adjusted to reflect the effects of the Share Split.

### **Revenue Recognition**

Revenue is recognized when a customer obtains control of promised goods or services and is recognized in an amount that reflects the consideration that an entity expects to receive in exchange for those goods or services. In addition, the standard requires disclosure of the nature, amount, timing, and uncertainty of revenue and cash flows arising from contracts with customers. The Company does not disaggregate its revenue streams as the economic factors underlying the contracts are similar and provide no significant distinction. The amount of revenue that is recorded reflects the consideration that the Company expects to receive in exchange for those goods or services. The Company applies the following five-step model in order to determine this amount: (i) identification of the promised goods or services in the contract; (ii) determination of whether the promised goods or services are performance obligations, including whether they are distinct in the context of the contract; (iii) measurement of the transaction price, including the constraint on variable consideration; (iv) allocation of the transaction price to the performance obligations; and (v) recognition of revenue when (or as) the Company satisfies each performance obligation.

The Company only applies the five-step model to contracts when it is probable that the entity will collect the consideration it is entitled to in exchange for the goods or services it transfers to the customer. Once a contract is determined to be within the scope of ASC 606 at contract inception, the Company reviews the contract to determine which performance obligations the Company must deliver and which of these performance obligations are distinct. The Company recognizes as revenues the amount of the transaction price that is allocated to the respective performance obligation when (or as) the performance obligation is satisfied.

### **Comprehensive Income or Loss**

ASC 220 “Comprehensive Income,” establishes standards for the reporting and display of comprehensive income and its components in the financial statements. For the six months ended December 31, 2022 and 2021, the Company established that there are items that represented components of comprehensive income and, therefore, has included a statement of operations and comprehensive loss in the financial statements.

### **Income Taxes**

The Company utilizes ASC Topic 740, “Income Taxes,” which requires the recognition of deferred tax assets and liabilities for the expected future tax consequences of events that have been included in the financial statements or tax returns. The Company accounts for income taxes using the asset and liability method to compute the differences between the tax basis of assets and liabilities and the related financial amounts, using enacted tax rates expected to apply to taxable income in the years in which those temporary differences are expected to be recovered or settled. The effect on deferred tax assets and liabilities of a change in tax rates is recognized in income in the period including the enactment date. Valuation allowances are established, when necessary, to reduce deferred tax assets to the amount expected to be realized. Current income taxes are provided for in accordance with the laws of the relevant taxing authorities. A valuation allowance is recorded when it is “more likely-than-not” that a deferred tax asset will not be realized.

FASB ASC 740 prescribes a recognition threshold and a measurement attribute for the financial statement recognition and measurement of tax positions taken or expected to be taken in a tax return. For those benefits to be recognized, a tax position must be more likely than not to be sustained upon examination by taxing authorities. The Company's practice is to recognize interest and penalties, if any, related to uncertain tax positions in income tax expense in the statements of operations and comprehensive loss. There were no unrecognized tax benefits as of December 31, 2022 and June 30, 2022.

### **Measurement of Fair Value**

The fair value of a financial instrument is the amount that could be received upon the sale of an asset or paid to transfer a liability in an orderly transaction between market participants at the measurement date. Financial assets are marked to bid prices and financial liabilities are marked to offer prices. Fair value measurements do not include transaction costs. A fair value hierarchy is used to prioritize the quality and reliability of the information used to determine fair values. Categorization within the fair value hierarchy is based on the lowest level of input that is significant to the fair value measurement. The fair value hierarchy is defined in the following three categories:

Level 1: applies to assets or liabilities for which there are quoted prices in active markets for identical assets or liabilities.

Level 2: applies to assets or liabilities for which there are inputs other than quoted prices included within Level 1 that are observable for the asset or liability such as quoted prices for similar assets or liabilities in active markets; quoted prices for identical assets or liabilities in markets with insufficient volume or infrequent transactions (less active markets); or model-derived valuations in which significant inputs are observable or can be derived principally from, or corroborated by, observable market data.

Level 3: applies to assets or liabilities for which there are unobservable inputs to the valuation methodology that are significant to the measurement of the fair value of the assets or liabilities.

At December 31, 2022 and June 30, 2022, the Company has no financial assets or liabilities subject to recurring fair value measurements.

The Company's financial instruments include cash, upfront payments, other receivables, other payables and related payables. Management estimates that the carrying amounts of financial instruments approximate their fair values due to their short-term nature. The fair value of amounts with immediate holding company is not practicable to estimate due to the related party nature of the underlying transactions.

### **Net Loss Per Share**

The Company has adopted ASC Topic 260, "Earnings per Share," ("EPS") which requires presentation of basic EPS on the face of the income statement for all entities with complex capital structures and requires a reconciliation of the numerator and denominator of the basic EPS computation. In the accompanying financial statements, basic earnings per share is computed by dividing net loss by the weighted average number of shares of ordinary shares outstanding during the period.

For the six months ended December 31, 2022, and 2021, the ordinary shares were included in the computation of diluted net loss per share.

### **Accumulated Other Comprehensive Income/(Loss)**

Unrealized gains and losses related to foreign currency translation are accumulated in "Accumulated other comprehensive loss" ("AOCI"). These changes are also reported in "Other comprehensive income (loss)" on the Condensed Consolidated Statements of Comprehensive Income.

### **Foreign Currency Translation**

The functional currency of the Company is the currency of the primary economic environment in which the Company operates, which is the Singapore dollars. The financial statements are presented in United States dollars (\$), which is the Company's presentation currency.

Assets and liabilities denominated in currencies other than the functional currency are remeasured using the current exchange rate for monetary accounts and historical exchange rates for nonmonetary accounts, with exchange differences on remeasurement included in comprehensive income in our Statements of Comprehensive Income.

The Company that utilizes foreign currency as their functional currency translate such currency into U.S. dollars using (i) the exchange rate on the balance sheet dates for assets and liabilities, (ii) the average exchange rates prevailing during the period for revenues and expenses, and (iii) historical exchange rates for equity. Any translation adjustments resulting from this process are shown separately as a component of accumulated other comprehensive loss within shareholders' deficit in Balance Sheets.

### **Recent Accounting Pronouncements**

In June 2016, the FASB issued ASU No. 2016-13, Financial Instruments – Credit Losses (Topic 326), Measurement of Credit Losses on Financial Instruments. This standard requires a financial asset (or group of financial assets) measured at amortized cost basis to be presented at the net amount expected to be collected. The allowance for credit losses is a valuation account that is deducted from the amortized cost basis of the financial asset(s) to present the net carrying value at the amount expected to be collected on the financial asset. This standard will be effective for the Company on January 1, 2023. The Company is currently evaluating the impact the adoption of this ASU will have on its consolidated financial statements.

In December 2019, the Financial Accounting Standards Board (FASB) issued Accounting Standard Update No. 2019-12, Income Taxes (Topic 740): Simplifying the Accounting for Income Taxes (ASU 2019-12), which simplifies the accounting for income taxes. This guidance will be effective for entities for the fiscal years, and interim periods within those fiscal years, beginning after December 15, 2020 on a prospective basis, with early adoption permitted. We adopted the new standard effective January 1, 2021 and the adoption of this guidance did not have a material impact on our financial statements.

We do not expect any other recently issued accounting standards to have a material impact on our financial position, results of operations or cash flows when they become effective.

#### NOTE 4 - DEPOSIT, UPFRONT PAYMENTS AND OTHER RECEIVABLES

Deposit, upfront payments and other receivables consists of the following:

	December 31, 2022	June 30, 2022
Deposits	\$ 45,575	\$ 44,971
Upfront Payments	247,332	51,840
Other receivables	9,719	5,452
Total	<u>\$ 302,626</u>	<u>\$ 102,263</u>

Deposit consists of the security deposit paid for lease of office, decreased due to refund of one month deposit from lessor.

Upfront payments as of December 31, 2022 and June 30, 2022 relates to the operating expenses paid in advance.

Other receivables relate to GST receivables.

#### NOTE 5 - PROPERTY AND EQUIPMENT, NET

Property and equipment consist of the following:

	Office Equipment	Total
<b>Cost</b>		
At July 1, 2021	\$ 15,453	\$ 15,453
Additions	1,229	1,229
Effects of movements in exchange rates	349	349
At December 31, 2021	<u>17,031</u>	<u>17,031</u>
At July 1, 2022	19,131	19,131
Additions	5,735	5,735
Disposal	(703)	(703)
Effects of movements in exchange rates	1,079	1,079
At December 31, 2022	<u>25,242</u>	<u>25,242</u>
<b>Accumulated depreciation</b>		
At July 1, 2021	\$ 5,209	\$ 5,209
Depreciation for the year	1,685	1,685
Effects of movements in exchange rates	102	102
At December 31, 2021	<u>6,996</u>	<u>6,996</u>
At July 1, 2022	\$ 8,522	\$ 8,522
Depreciation for the year	2,222	2,222
Disposal	(443)	(443)
Effects of movements in exchange rates	347	347
At December 31, 2022	<u>10,648</u>	<u>10,648</u>
<b>Carrying amounts</b>		
At July 1, 2021	\$ 10,244	\$ 10,244
At December 31, 2021	\$ 10,035	\$ 10,035
At July 1, 2022	\$ 10,607	\$ 10,607
At December 31, 2022	\$ 14,594	\$ 14,594

Depreciation expense for the six months ended December 31, 2022 and 2021 was \$2,222 and \$1,685 respectively.

During the six months ended December 31, 2022, the Company purchased assets of \$5,735 (\$8,178) and disposed of asset of \$703 (\$952). During the six months ended December 31, 2021, the Company purchased assets of \$1,229 (\$1,709).

## NOTE 6 – LEASES

As of December 31, 2022 and June 30, 2022, the Company has operating lease agreement for its office premises. Leases with an initial term of 12 months or less are not recorded on the balance sheet. The Company accounts for the lease and non-lease components of its leases as a single lease component. Lease expense is recognized on a straight-line basis over the lease term.

Operating lease right-of-use (“ROU”) assets and liabilities are recognized at commencement date based on the present value of lease payments over the lease term. ROU assets represent our right to use an underlying asset for the lease term and lease liabilities represent our obligation to make lease payments arising from the lease. Generally, the implicit rate of interest (“discount rate”) in arrangements is not readily determinable and the Company utilizes its incremental borrowing rate in determining the present value of lease payments. The Company’s incremental borrowing rate is a hypothetical rate based on its understanding of what its credit rating would be. The operating lease ROU asset includes any lease payments made and excludes lease incentives.

### Operating lease

The Company has entered into commercial operating leases for the use of office premises in Singapore. The lease has varying terms, escalation clauses and run for a period of three years with an option to renew the lease after that term. During the period ended December 31, 2022, the Company has renewed the operating lease for the office premise for a period of two years which expires in September 2024.

When measuring lease liabilities for leases that were classified as operating leases as of December 31, 2022 and June 30, 2022, the Company discounted lease payments using its estimated borrowing rate of 5.25%.

Information pertaining to lease amounts recognized in financial statements is summarized as follows:

	December 31, 2022	June 30, 2022
<b>Assets:</b>		
ROU asset	\$ 305,829	\$ 44,925
<b>Liabilities:</b>		
<b>Current:</b>		
Operating lease liabilities	\$ 169,334	\$ 36,385
<b>Non-current</b>		
Operating lease liabilities	124,918	-
<b>Total lease liabilities</b>	<u>\$ 294,252</u>	<u>\$ 36,385</u>

Minimum lease payments for the Company’s operating lease liabilities were as follows for the period ended December 31:

	<b>Operating leases</b>
2023	\$ 169,334
2024	124,918
2025	-
Total operating lease payment	<u>\$ 294,252</u>

## NOTE 7 – IMMEDIATE HOLDING COMPANY BALANCES

The Company follows ASC 850, “Related Party Disclosures,” for the identification of related parties and disclosure of related party transactions.

Related parties are any entities or individuals that, through employment, ownership or other means, possess the ability to direct or cause the direction of the management and policies of the Company.

### Directors’ remuneration

The Directors’ remuneration for the six months ended December 31, 2022 and 2021 as follow:

	For the six months ended December 31,	
	2022	2021
Andrew Khine	\$ -	\$ 34,426
Shusuke Oguro	-	35,489
Hiroshi Ilzuka	-	17,745
Teo Lai Wah, Timothy	16,548	11,141
Goh Chao Kuang	66,136	-
Hilda Sin Mei Fong	31,659	-
Total	<u>\$ 114,343</u>	<u>\$ 98,801</u>

## Amounts due to immediate holding company

As of December 31, 2022 and June 30, 2022, the Company reported amounts due to immediate holding company, 3DOM Alliance Inc. of amount \$1,681,003 and \$974,632, respectively.

The transactions amount due to an immediate holding company are as of the following:

	December 31, 2022	June 30, 2022
Beginning of the period	\$ 974,632	\$ 1,531,488
Advances for operation and administration expenses	1,496,658	873,066
Expenses paid on behalf of Company	-	117,882
Ordinary shares issued for conversion of debt	(790,287)	(1,547,804)
Period ended	\$ 1,681,003	\$ 974,632

On August 1, 2020, 3DOM Alliance Inc. issued a promissory note with principal amount up to S\$1,000,000 (“Original Promissory Note”) to the Company. The promissory is interest free and 3DOM Alliance Inc will not demand any payment for at least the next twelve months from the issuance of the financial statements (refer to Note 2). The Company received proceeds amounting to \$36,661 (S\$61,155) and \$682,467 (S\$938,845), respectively, from 3DOM Alliance Inc. during the year ended June 30, 2020 and 2021. See Note 12 for amendments effected on the Original Promissory Note subsequent to June 30, 2022.

On October 21, 2021, the Company agreed with 3DOM Alliance Inc. to convert the debt amounting to \$1,547,804 into ordinary shares of the Company at \$100 per share. The Company issued 15,478 shares of ordinary shares on October 22, 2021.

On July 15, 2022, the Company agreed with 3DOM Alliance Inc. to convert the debt amount to \$790,287 into ordinary shares of the Company at \$1,041 per share. The Company issued 759 shares of ordinary shares on July 18, 2022.

## NOTE 8 - SHAREHOLDERS' EQUITY

On October 22, 2021, the Company issued 309,560 shares of ordinary shares (pre 1:20 share split - 15,478 ordinary shares) to 3DOM Alliance Inc. in connection with the conversion of debt (refer to Note 7).

On April 28, 2022, shareholder of our company and board of directors approved shares split of our issued ordinary shares on a basis of one-for-twenty.

As of June 30, 2022 and 2021, the Company had 311,560 shares (pre 1: 20 share split – 15,578 shares) and 2,000 shares (pre 1: 20 share split – 100 shares) of ordinary shares issued, respectively.

On July 18, 2022, the Company issued 759 shares of ordinary shares to 3DOM Alliance Inc. in connection with the conversion of debt (refer to Note 7).

## NOTE 9 – INCOME TAX

noco-noco Pte. Ltd. is incorporated in Singapore, and under the current tax laws of Singapore, its standard corporate income tax rate is 17%.

Due to the Company's net loss position, there was no provision for income taxes recorded.

	For the six months ended December 31,	
	2022	2021
<b>Loss before tax</b>	\$ 1,154,651	\$ 602,828
Tax rate	17%	17%
Computed tax benefit (expense) at statutory tax rate	196,291	102,481
<b>Tax effect of non-deductible or taxable items:</b>		
Additional deduction for R&D expenses	-	11,680
Non-deductible Professional fees	-	-
Non-taxable Income	26,987	8,635
Change in valuation allowance	(223,278)	(122,796)
Effect of preferential tax rates	-	-
<b>Income tax expense (benefit)</b>	-	-

The Company evaluates each uncertain tax position (including the potential application of interest and penalties) based on the technical merits, and measure the unrecognized benefits associated with the tax positions. As of December 31, 2022 and June 30, 2022, the Company did not have any significant unrecognized uncertain tax positions. The Company did not accrue any liability, interest or penalties related to uncertain tax positions in its provision for income taxes line of its consolidated statements of operations for the six months ended December 31, 2022 and 2021. The Company does not believe that its uncertain tax benefits position will materially change over the next twelve months.

As of December 31, 2022, Singapore tax returns for the years 2020 to 2022 are subject to examination by the tax authorities.

Deferred taxes were measured using the enacted tax rates for the periods in which the temporary differences are expected to be reversed. The tax effects of temporary differences that give rise to the deferred tax balances as of December 31, 2022 and June 30, 2021 are as follows:

	December 31, 2022	June 30, 2022
<b>Deferred tax assets</b>		
Net operating loss carry-forward	\$ 636,255	\$ 391,243
Capital allowance	4,291	3,253
Lease liabilities	50,023	6,185
Other provisions	-	22,470
Less: valuation allowance	(638,578)	(415,300)
Subtotal	51,991	7,851



<b>Deferred tax liabilities</b>		
Deferred tax liabilities arising from assets	(51,991)	(7,851)
Total deferred tax assets, net	-	-

The Company had net operating loss carried forward for tax purposes of approximately \$3,506,000 as of December 31, 2022 and approximately \$2,351,000 as of June 30, 2022, which may be carried forward to offset future taxable income.

	December 31, 2022	June 30, 2022
<b>The changes related to valuation allowance are as follows:</b>		
Balance at the beginning of the year	\$ 415,300	\$ 220,560
Current year addition	223,278	194,740
Balance at the end of the year	<u>638,578</u>	<u>415,300</u>

**NOTE 10 – COMMITMENTS AND CONTINGENCIES**

In the normal course of business, we are subject to loss contingencies, such as legal proceedings and claims arising out of our business, that cover a wide range of matters, including, among others, government investigations and tax matters. In accordance with ASC No. 450-20, "Loss Contingencies", we will record accruals for such loss contingencies when it is probable that a liability has been incurred and the amount of loss can be reasonably estimated. In the opinion of management, there were no pending or threatened claims and litigation as of December 31, 2022 and through May 15, 2023, the date the financial statements were available to be issued.

**NOTE 11- SUBSEQUENT EVENTS**

The Company has evaluated subsequent events through the date of issuance of the unaudited condensed financial statements. Based upon this review, the Company did not identify any subsequent events that would have required adjustment or disclosure in the financial statements.



## REPORT OF INDEPENDENT REGISTERED PUBLIC ACCOUNTING FIRM

To the Shareholders and Board of Directors of noco-noco Pte. Ltd. (f.k.a 3DOM (Singapore) Pte. Ltd.)

### Opinion on the Financial Statements

We have audited the accompanying balance sheets of noco-noco Pte. Ltd. (f.k.a. 3DOM (Singapore) Pte. Ltd.) (the “Company”) as of June 30, 2022 and 2021, the related statements of operations and comprehensive loss, shareholders’ equity (deficit) and cash flows for each of the two years in the period ended June 30, 2022, and the related notes (collectively referred to as the “financial statements”). In our opinion, the financial statements present fairly, in all material respects, the financial position of the Company as of June 30, 2022 and 2021, and the results of its operations and its cash flows for each of the two years in the period ended June 30, 2022, in conformity with accounting principles generally accepted in the United States of America.

### Basis for Opinion

These financial statements are the responsibility of the Company’s management. Our responsibility is to express an opinion on the Company’s financial statements based on our audit. We are a public accounting firm registered with the Public Company Accounting Oversight Board (United States) (“PCAOB”) and are required to be independent with respect to the Company in accordance with the U.S. federal securities laws and the applicable rules and regulations of the Securities and Exchange Commission and the PCAOB.

We conducted our audit in accordance with the standards of the PCAOB and in accordance with auditing standards generally accepted in the United States of America. Those standards require that we plan and perform the audit to obtain reasonable assurance about whether the financial statements are free of material misstatement, whether due to error or fraud. The Company is not required to have, nor were we engaged to perform, an audit of its internal control over financial reporting. As part of our audit we are required to obtain an understanding of internal control over financial reporting but not for the purpose of expressing an opinion on the effectiveness of the Company’s internal control over financial reporting. Accordingly, we express no such opinion.

Our audit included performing procedures to assess the risks of material misstatement of the financial statements, whether due to error or fraud, and performing procedures that respond to those risks. Such procedures included examining, on a test basis, evidence regarding the amounts and disclosures in the financial statements. Our audit also included evaluating the accounting principles used and significant estimates made by management, as well as evaluating the overall presentation of the financial statements. We believe that our audit provides a reasonable basis for our opinion.

/s/ Marcum Asia CPAs LLP

**Marcum Asia CPAs LLP**

We have served as the Company’s auditor since 2022.

**New York**

**February 10, 2023**

**NOCO-NOCO PTE. LTD**  
**BALANCE SHEETS**  
(Amounts expressed in US dollars (“\$”) except for numbers of shares)

	June 30, 2022	June 30, 2021
<b>ASSETS</b>		
<b>Current assets</b>		
Cash and cash equivalents	\$ 81,626	\$ 31,690
Inventories	-	163,259
Deposit, upfront payments and other receivables	102,263	83,385
<b>Total current assets</b>	<b>183,889</b>	<b>278,334</b>
<b>Non-current assets</b>		
Property and equipment, net	10,607	10,244
Right of use assets – operating lease, net	44,925	221,305
<b>Total assets</b>	<b>\$ 239,421</b>	<b>\$ 509,883</b>
<b>Liabilities and Shareholders' (Deficit) Equity</b>		
<b>Current liabilities</b>		
Accruals and other payables	\$ 13,227	\$ 9,856
Amount due to immediate holding company	974,632	1,531,488
Operating lease liability – current	36,385	173,421
<b>Total current liabilities</b>	<b>1,024,244</b>	<b>1,714,765</b>
<b>Non-current liabilities</b>		
Operating lease liability – non-current	-	36,779
<b>Total liabilities</b>	<b>\$ 1,024,244</b>	<b>\$ 1,751,544</b>
<b>Shareholders' deficit</b>		
Ordinary stock (unlimited shares authorized, no par value, 311,560 and 100 shares issued and outstanding as of June 30, 2022 and 2021, respectively)	\$ 1,557,804	\$ 10,000
Accumulated deficit	(2,351,743)	(1,274,920)
Accumulated other comprehensive income	9,116	23,259
<b>Total shareholders' deficit</b>	<b>\$ (784,823)</b>	<b>\$ (1,241,661)</b>
<b>Total liabilities and shareholder's deficit</b>	<b>\$ 239,421</b>	<b>\$ 509,883</b>

The accompanying notes are an integral part of these financial statements.

NOCO-NOCO PTE. LTD  
STATEMENTS OF OPERATIONS AND COMPREHENSIVE LOSS

	June 30, 2022	June 30, 2021
<b>Operating expenses:</b>		
Research and development	\$ 137,412	\$ 4,948
Selling, general and administrative expenses	951,239	717,298
<b>Total operating expenses</b>	<u>1,088,651</u>	<u>722,246</u>
<b>Loss from operations</b>	(1,088,651)	(722,246)
<b>Other income/(expense):</b>		
Other income	11,792	65,434
Other expense	-	(14,999)
Foreign exchange gain	36	-
<b>Total other income</b>	<u>11,828</u>	<u>50,435</u>
<b>Net loss</b>	(1,076,823)	(671,811)
<b>Other comprehensive (loss)/income:</b>		
Foreign currency translation adjustment	(14,143)	6,431
<b>Comprehensive loss</b>	<u>(1,090,966)</u>	<u>(665,380)</u>
Basic and diluted loss per ordinary share	\$ (5.08)	\$ (332.69)
Basic and diluted weighted average number of ordinary shares outstanding	<u>214,876</u>	<u>2,000</u>

The accompanying notes are integral to these financial statements.

**NOCO-NOCO PTE. LTD**  
**STATEMENTS OF CHANGES IN SHAREHOLDERS' EQUITY (DEFICIT)**

	Ordinary shares		Accumulated Other Comprehensive Income (Loss)	Accumulated Deficit	Total
	Number of shares	Amount			
<b>Balance as of June 30, 2020</b>	<b>2,000</b>	<b>\$ 10,000</b>	<b>\$ 16,828</b>	<b>\$ (603,109)</b>	<b>\$ (576,281)</b>
Foreign currency translation adjustment	-	-	6,431	-	6,431
Net loss	-	-	-	(671,811)	(671,811)
<b>Balance as of June 30, 2021</b>	<b>2,000</b>	<b>\$ 10,000</b>	<b>\$ 23,259</b>	<b>\$ (1,274,920)</b>	<b>\$ (1,241,661)</b>
Ordinary shares issued for conversion of debt	309,560	1,547,804	-	-	1,547,804
Foreign currency translation adjustment	-	-	(14,143)	-	(14,143)
Net loss	-	-	-	(1,076,823)	(1,076,823)
<b>Balance as of June 30, 2022</b>	<b>311,560</b>	<b>\$ 1,557,804</b>	<b>\$ 9,116</b>	<b>\$ (2,351,743)</b>	<b>\$ (784,823)</b>

The accompanying notes are integral to these financial statements.

**NOCO-NOCO PTE. LTD**  
**STATEMENTS OF CASH FLOWS**

	<b>June 30,2022</b>	<b>June 30, 2021</b>
<b>Cash flows from operating activities</b>		
Net loss	\$ (1,076,823)	\$ (671,811)
Adjustments for reconcile net loss to net cash used in operating activities:		
Depreciation	3,447	3,158
Changes in operating assets and liabilities:		
Inventories	163,259	(163,259)
Deposit, upfront payments and other receivables	(18,878)	(22,957)
Accruals and other payables	121,253	141,725
Operating lease liabilities	2,565	(10,163)
<b>Net cash used in operations</b>	<u>(805,177)</u>	<u>(723,307)</u>
<b>Cash flows from investing activities</b>		
Purchase of property and equipment	(3,888)	-
<b>Cash used in investing activities</b>	<u>(3,888)</u>	<u>-</u>
<b>Cash flows from financing activities</b>		
Proceeds from immediate holding company	873,066	689,781
<b>Cash generated from financing activities</b>	<u>873,066</u>	<u>689,781</u>
Increase/(decrease) in cash and cash equivalents	64,001	(33,526)
Effect of exchange rate changes	(14,065)	6,184
Cash and cash equivalents at beginning of period	31,690	59,032
Cash and cash equivalents at end of period	<u>\$ 81,626</u>	<u>\$ 31,690</u>
<b>Supplemental cash flow information:</b>		
<b>Cash paid during the period for:</b>		
Interest	\$ -	\$ -
<b>Supplemental disclosure of non-cash investing and financing information:</b>		
Issuance of ordinary shares for conversion of debt	<u>\$ 1,547,804</u>	<u>\$ -</u>

The accompanying footnotes are an integral part of these financial statements.

**NOCO-NOCO PTE. LTD.**  
**NOTES TO THE FINANCIAL STATEMENTS**  
**JUNE 30, 2022 and 2021**  
**(Amounts expressed in US dollars (“\$”) except for numbers of shares)**

**NOTE 1 – ORGANIZATION AND NATURE OF OPERATIONS**

The Company incorporated as a Singapore corporation on July 25, 2019 under the name 3DOM (Singapore) Pte. Ltd. The Company is wholly owned by 3DOM Alliance Inc., a Company incorporated in Japan and the ultimate controlling shareholder is Mr. Masataka Matsumara.

On November 9, 2022, the Company changed its name from 3DOM (Singapore) Pte. Ltd. to noco-noco Pte. Ltd.

noco-noco Pte. Ltd. (“we”, “our”, “us” or collectively known as the “Company”) is a platform-solution provider of decarbonization offerings, aiming to truly solve urgent environmental crises through the comprehensive decarbonization of all forms of transportation.

**NOTE 2 - LIQUIDITY**

As of June 30, 2022 and 2021, the Company had an accumulated deficit of \$2,351,743 and \$1,274,920 respectively. The Company incurred net loss of \$1,076,823 and \$671,811 for the financial years ended June 30, 2022 and 2021, respectively. The cash used in operating activities for the financial year ended June 30, 2022 and 2021, was \$805,177 and \$723,307, respectively.

The Company’s liquidity is based on its ability to generate cash from operating activities, obtain capital financing from equity interest investors and borrow funds on favorable economic terms to fund its general operations and capital expansion needs. The Company’s ability to continue as a going concern is dependent on management’s ability to successfully execute its business plan, which includes increasing revenue while controlling operating cost and expenses to generate positive operating cash flows and obtaining funds from outside sources of financing to generate positive financing cash flows. As of June 30, 2022, the Company’s balance of cash and cash equivalents was \$81,626. In addition, up to February 6, 2023, the immediate holding Company, 3DOM Alliance Inc, has extended the Promissory Note for the Company with a principal amount up to \$6,022,258 (\$8,000,000) and the Company has received financing of \$2,243,291 (\$2,980,000) from 3DOM Alliance Inc. Moreover, 3DOM Alliance Inc will not demand for payment on the amounts owing by the Company for at least the next twelve months from the issuance of the financial statements.

Based on cash flows projection from operating and financing activities and existing balance of cash and cash equivalents, management is of the opinion that the Company has sufficient funds for sustainable operations and it will be able to meet its payment obligations from operations and debt related commitments for the next twelve months from the issuance of the financial statements. Moreover, the management can adjust the pace of its operation expansion and control the operating expenses of the Company. Based on the above considerations, the Company’s financial statements have been prepared on a going concern basis, which contemplates the realization of assets and liquidation of liabilities during the normal course of operations.

**NOTE 3 - SUMMARY OF SIGNIFICANT ACCOUNTING POLICIES**

**Basis of Presentation**

Our financial statements have been prepared in conformity with U.S. generally accepted accounting principles (“GAAP”) in U.S. dollars. We have made all the adjustments that we believe are necessary for a fair presentation of our financial statements.

**Use of estimates**

The preparation of the financial statements in conformity with US GAAP requires management of the Company to make a number of estimates and assumptions relating to the reported amounts of assets and liabilities and the disclosure of contingent assets and liabilities at the date of the financial statements and the reported amounts of revenues and expenses during the reporting period. On an on-going basis we review our estimates and assumptions. The estimates were based on historical experience and other assumptions that we believe to be reasonable under the circumstances. Actual results could differ from those estimates under different assumptions or conditions, but we do not believe such differences will materially affect our financial position or results of operations



**Fiscal Year End**

The Company operates on a fiscal year basis with the fiscal year ending on June 30.

**Cash and Cash Equivalents**

Cash and cash equivalents consist of cash on hand and demand deposit with banks, which are unrestricted as to withdrawal and use, and which have original maturities of three months or less when purchased.

**Inventories**

Inventories, consisting of finished goods, are primarily accounted for using the first-in-first-out ("FIFO") method of accounting. Inventories are measured at the lower of cost and net realizable value. Cost consists of the price purchase stock and the Company estimates the net realizable value of inventories based on an assessment of expected sales prices. Demand levels and pricing competition could change from time to time. If such factors result in an adverse effect on the Company's products, the Company might be required to reduce the value of its inventories.

**Deposit, upfront payments and other receivables**

Security deposits paid for office lease are accounted for as deposit. Amounts paid in advance for future expenses are accounted for as prepaid expenses. Goods and Service Tax ("GST") refunds and collection of proceed from sales of batteries to business partner are accounted for as other receivables.

**Property and equipment**

Property and equipment are stated at cost, less accumulated depreciation. Expenditures for additions, major renewals and betterments are capitalized and expenditures for maintenance and repairs are charged to expense as incurred.

Depreciation is computed using the straight-line method over the estimated useful lives of the related capitalized assets. The estimated useful lives are as follows:

	<u>Useful lives</u>
Office equipment	5 years

**Other current liabilities**

Other current liabilities are liabilities for goods and services provided to the Company prior to the end of the financial year which are unpaid. They are classified as current liabilities if payment is due within one year or less. If not, they are presented as non-current liabilities.

**Leases**

We have entered into operating lease agreements primarily for office. We determine if an arrangement is a lease at inception. For all classes of underlying assets, we elect not to recognize right of use assets or lease liabilities when a lease has a lease term of 12 months or less at the commencement date and does not include an option to purchase the underlying asset that we are reasonably certain to exercise. Operating lease assets and liabilities are included on our balance sheet as of June 30, 2022 and 2021.

Operating lease assets and liabilities are recognized at the present value of the future lease payments at the lease commencement date. The interest rate used to determine the present value of the future lease payments is our incremental borrowing rate, because the interest rate implicit in most of our leases is not readily determinable. Our incremental borrowing rate is estimated to approximate the interest rate on a collateralized basis with similar terms and payments, and in economic environments where the leased asset is located. Operating lease assets also include any prepaid lease payments and lease incentives. Our lease terms include periods under options to extend or terminate the lease when it is reasonably certain that we will exercise that option. We generally use the base, non-cancellable, lease term when determining the lease assets and liabilities. Operating lease expense is recognized on a straight-line basis over the lease term.

### **Share Split**

On April 27, 2022, our Board of Directors declared a one-for-twenty shares split of our ordinary shares (“Share Split”). There was no net effect on the total stockholders' equity, and the par value per share of our ordinary shares remains unchanged at \$-0- per share after the Share Split. All references made to share or per share amounts in the accompanying financial statements and applicable disclosures have been retroactively adjusted to reflect the effects of the Share Split.

### **Revenue Recognition**

Revenue is recognized when a customer obtains control of promised goods or services and is recognized in an amount that reflects the consideration that an entity expects to receive in exchange for those goods or services. In addition, the standard requires disclosure of the nature, amount, timing, and uncertainty of revenue and cash flows arising from contracts with customers. The Company does not disaggregate its revenue streams as the economic factors underlying the contracts are similar and provide no significant distinction. The amount of revenue that is recorded reflects the consideration that the Company expects to receive in exchange for those goods or services. The Company applies the following five-step model in order to determine this amount: (i) identification of the promised goods or services in the contract; (ii) determination of whether the promised goods or services are performance obligations, including whether they are distinct in the context of the contract; (iii) measurement of the transaction price, including the constraint on variable consideration; (iv) allocation of the transaction price to the performance obligations; and (v) recognition of revenue when (or as) the Company satisfies each performance obligation.

The Company only applies the five-step model to contracts when it is probable that the entity will collect the consideration it is entitled to in exchange for the goods or services it transfers to the customer. Once a contract is determined to be within the scope of ASC 606 at contract inception, the Company reviews the contract to determine which performance obligations the Company must deliver and which of these performance obligations are distinct. The Company recognizes as revenues the amount of the transaction price that is allocated to the respective performance obligation when (or as) the performance obligation is satisfied.

### **Comprehensive Gain or Loss**

ASC 220 “Comprehensive Income,” establishes standards for the reporting and display of comprehensive income and its components in the financial statements. As of June 30, 2022 and 2021, the Company established that there are items that represented components of comprehensive income and, therefore, has included a statement of operations and comprehensive loss in the financial statements.

### **Income Taxes**

The Company utilizes ASC Topic 740, “Income Taxes,” which requires the recognition of deferred tax assets and liabilities for the expected future tax consequences of events that have been included in the financial statements or tax returns. The Company accounts for income taxes using the asset and liability method to compute the differences between the tax basis of assets and liabilities and the related financial amounts, using enacted tax rates expected to apply to taxable income in the years in which those temporary differences are expected to be recovered or settled. The effect on deferred tax assets and liabilities of a change in tax rates is recognized in income in the period including the enactment date. Valuation allowances are established, when necessary, to reduce deferred tax assets to the amount expected to be realized. Current income taxes are provided for in accordance with the laws of the relevant taxing authorities. A valuation allowance is recorded when it is “more likely-than-not” that a deferred tax asset will not be realized.

FASB ASC 740 prescribes a recognition threshold and a measurement attribute for the financial statement recognition and measurement of tax positions taken or expected to be taken in a tax return. For those benefits to be recognized, a tax position must be more likely than not to be sustained upon examination by taxing authorities. The Company's practice is to recognize interest and penalties, if any, related to uncertain tax positions in income tax expense in the statements of operations and comprehensive loss. There were no unrecognized tax benefits as of June 30, 2022 and 2021.

### **Measurement of Fair Value**

The fair value of a financial instrument is the amount that could be received upon the sale of an asset or paid to transfer a liability in an orderly transaction between market participants at the measurement date. Financial assets are marked to bid prices and financial liabilities are marked to offer prices. Fair value measurements do not include transaction costs. A fair value hierarchy is used to prioritize the quality and reliability of the information used to determine fair values. Categorization within the fair value hierarchy is based on the lowest level of input that is significant to the fair value measurement. The fair value hierarchy is defined in the following three categories:

Level 1: applies to assets or liabilities for which there are quoted prices in active markets for identical assets or liabilities.

Level 2: applies to assets or liabilities for which there are inputs other than quoted prices included within Level 1 that are observable for the asset or liability such as quoted prices for similar assets or liabilities in active markets; quoted prices for identical assets or liabilities in markets with insufficient volume or infrequent transactions (less active markets); or model-derived valuations in which significant inputs are observable or can be derived principally from, or corroborated by, observable market data.

Level 3: applies to assets or liabilities for which there are unobservable inputs to the valuation methodology that are significant to the measurement of the fair value of the assets or liabilities.

At June 30, 2022 and 2021, the Company has no financial assets or liabilities subject to recurring fair value measurements.

The Company's financial instruments include cash, upfront payments, other receivables, other payables and related payables. Management estimates that the carrying amounts of financial instruments approximate their fair values due to their short-term nature. The fair value of amounts with immediate holding company is not practicable to estimate due to the related party nature of the underlying transactions.

### **Net Loss Per Share**

The Company has adopted ASC Topic 260, "*Earnings per Share*," ("EPS") which requires presentation of basic EPS on the face of the income statement for all entities with complex capital structures and requires a reconciliation of the numerator and denominator of the basic EPS computation. In the accompanying financial statements, basic earnings per share is computed by dividing net loss by the weighted average number of shares of ordinary shares outstanding during the period.

For the periods ended June 30, 2022, and 2021, the ordinary shares were included in the computation of diluted net loss per share.

### **Accumulated Other Comprehensive Income/(Loss)**

Unrealized gains and losses related to foreign currency translation are accumulated in "Accumulated other comprehensive loss" ("AOCI"). These changes are also reported in "Other comprehensive income (loss)" on the Condensed Consolidated Statements of Comprehensive Income.

### **Foreign Currency Translation**

The functional currency of the Company is the currency of the primary economic environment in which the Company operates. Assets and liabilities denominated in currencies other than the functional currency are remeasured using the current exchange rate for monetary accounts and historical exchange rates for nonmonetary accounts, with exchange differences on remeasurement included in comprehensive income in our Statements of Comprehensive Income.

The Company that utilizes foreign currency as their functional currency translate such currency into U.S. dollars using (i) the exchange rate on the balance sheet dates for assets and liabilities, (ii) the average exchange rates prevailing during the period for revenues and expenses, and (iii) historical exchange rates for equity. Any translation adjustments resulting from this process are shown separately as a component of accumulated other comprehensive loss within shareholders' deficit in Balance Sheets.

### **Recent Accounting Pronouncements**

In June 2016, the FASB issued ASU No. 2016-13, Financial Instruments – Credit Losses (Topic 326), Measurement of Credit Losses on Financial Instruments. This standard requires a financial asset (or group of financial assets) measured at amortized cost basis to be presented at the net amount expected to be collected. The allowance for credit losses is a valuation account that is deducted from the amortized cost basis of the financial asset(s) to present the net carrying value at the amount expected to be collected on the financial asset. This standard will be effective for the Company on January 1, 2023. The Company is currently evaluating the impact the adoption of this ASU will have on its consolidated financial statements.

In December 2019, the Financial Accounting Standards Board (FASB) issued Accounting Standard Update No. 2019-12, Income Taxes (Topic 740): Simplifying the Accounting for Income Taxes (ASU 2019-12), which simplifies the accounting for income taxes. This guidance will be effective for entities for the fiscal years, and interim periods within those fiscal years, beginning after December 15, 2020 on a prospective basis, with early adoption permitted. We adopted the new standard effective January 1, 2021 and the adoption of this guidance did not have a material impact on our financial statements.

We do not expect any other recently issued accounting standards to have a material impact on our financial position, results of operations or cash flows when they become effective.

#### NOTE 4 - INVENTORIES

Inventories consist of the following:

	<u>June 30, 2022</u>	<u>June 30, 2021</u>
Finished goods	\$ -	\$ 163,259

The inventories were purchased from immediate holding company, 3DOM Alliance Inc.

The finished goods were written off during the financial period ended 30 June 2022 as they were deemed obsolete.

#### NOTE 5 - DEPOSIT, UPFRONT PAYMENTS AND OTHER RECEIVABLES

Deposit, upfront payments and other receivables consists of the following:

	<u>June 30, 2022</u>	<u>June 30, 2021</u>
Deposits	\$ 44,971	\$ 60,486
upfront payments	51,840	6,216
Other receivables	5,452	16,683
Total	<u>\$ 102,263</u>	<u>\$ 83,385</u>

Deposit consists of the security deposit paid for lease of office, decreased due to refund of one month deposit from lessor.

Upfront payments as of June 30, 2022 and 2021 relates to the operating expenses paid in advance.

Other receivables relate to GST receivables and one-off battery sale to a business partner.

#### NOTE 6 - PROPERTY AND EQUIPMENT, NET

Property and equipment consist of the following:

	<u>Office Equipment</u>	<u>Total</u>
<b>Cost</b>		
At July 1, 2020	\$ 15,244	\$ 15,244
Effects of movements in exchange rates	209	209
At June 30, 2021	15,453	15,453
Additions	3,888	3,888
Effects of movements in exchange rates	(210)	(210)
At June 30, 2022	<u>19,131</u>	<u>19,131</u>
<b>Accumulated depreciation</b>		
At July 1, 2020	\$ 2,090	\$ 2,090
Depreciation for the year	3,158	3,158
Effects of movements in exchange rates	(39)	(39)
At June 30, 2021	5,209	5,209
Depreciation for the year	3,447	3,447
Effects of movements in exchange rates	(132)	(132)
At June 30, 2022	<u>8,524</u>	<u>8,524</u>
<b>Carrying amounts</b>		
At July 1, 2020	\$ 13,154	\$ 13,154
At June 30, 2021	\$ 10,244	\$ 10,244
At June 30, 2022	<u>\$ 10,607</u>	<u>\$ 10,607</u>

Depreciation expense for the year ended June 30, 2022 and 2021 was \$3,447 and \$3,158, respectively.

During the year ended June 30, 2022, the Company purchased assets of \$3,888 (\$5,345). There is no purchase or disposal of assets during the year ended June 30, 2021.

## NOTE 7 – LEASES

As of June 30, 2022 and 2021, the Company has operating lease agreement for its office premises. Leases with an initial term of 12 months or less are not recorded on the balance sheet. The Company accounts for the lease and non-lease components of its leases as a single lease component. Lease expense is recognized on a straight-line basis over the lease term.

Operating lease right-of-use (“ROU”) assets and liabilities are recognized at commencement date based on the present value of lease payments over the lease term. ROU assets represent our right to use an underlying asset for the lease term and lease liabilities represent our obligation to make lease payments arising from the lease. Generally, the implicit rate of interest (“discount rate”) in arrangements is not readily determinable and the Company utilizes its incremental borrowing rate in determining the present value of lease payments. The Company’s incremental borrowing rate is a hypothetical rate based on its understanding of what its credit rating would be. The operating lease ROU asset includes any lease payments made and excludes lease incentives.

### Operating lease

The Company has entered into commercial operating leases for the use of office premises in Singapore. The lease has varying terms, escalation clauses and run for a period of three years with an option to renew the lease after that term.

When measuring lease liabilities for leases that were classified as operating leases as of June 30, 2022 and 2021, the Company discounted lease payments using its estimated borrowing rate of 5.25%.

Information pertaining to lease amounts recognized in financial statements is summarized as follows:

	<u>June 30, 2022</u>	<u>June 30, 2021</u>
Assets:		
ROU asset	\$ 44,925	\$ 221,305
Liabilities:		
Current:		
Operating lease liabilities	\$ 36,385	\$ 173,421
Non-current		
Operating lease liabilities	-	36,779
<b>Total lease liabilities</b>	<u>\$ 36,385</u>	<u>\$ 210,200</u>

Minimum lease payments for the Company’s operating lease liabilities were as follows for the twelve-month period ended June 30:

	<u>Operating leases</u>
2023	\$ 36,385
2024	-
2025	-
Total operating lease payment	<u>\$ 36,385</u>

## NOTE 8 – IMMEDIATE HOLDING COMPANY BALANCES

The Company follows ASC 850, “Related Party Disclosures,” for the identification of related parties and disclosure of related party transactions.

Related parties are any entities or individuals that, through employment, ownership or other means, possess the ability to direct or cause the direction of the management and policies of the Company.

### Directors’ remuneration

The Directors’ remuneration for the financial years ended June 30, 2022 and 2021 as follow:

	<u>June 30, 2022</u>	<u>June 30, 2021</u>
Andrew Khine	\$ 68,242	\$ 223,448
Shusuke Oguro	76,222	-
Hiroshi Ilzuka	41,857	-
Teo Lai Wah, Timothy	27,580	-
Total	<u>\$ 213,901</u>	<u>\$ 223,448</u>

## Amounts due to immediate holding company

As of June 30, 2022 and 2021, the Company reported amounts due to immediate holding company, 3DOM Alliance Inc. of amount \$974,632 and \$1,531,488, respectively.

The transactions amount due to an immediate holding company are as of the following:

	June 30, 2022	June 30, 2021
Beginning of the year Jul 1	\$ 1,531,488	\$ 677,144
Advances for operation and administration expenses	873,066	832,435
Expenses paid on behalf of Company	117,882	-
Proceed from promissory note	-	4,842
Purchase of lithium-ion batteries	-	17,067
Ordinary shares issued for conversion of debt	(1,547,804)	-
Year ended June 30	<u>\$ 974,632</u>	<u>\$ 1,531,488</u>

On August 1, 2020, 3DOM Alliance Inc. issued a promissory note with principal amount up to S\$1,000,000 ("Original Promissory Note") to the Company. The promissory is interest free and 3DOM Alliance Inc will not demand any payment for at least the next twelve months from the issuance of the financial statements (refer to Note 2). The Company received proceeds amounting to \$36,661 (\$61,155) and \$682,467 (\$938,845), respectively, from 3DOM Alliance Inc. during the year ended June 30, 2020 and 2021. See Note 12 for amendments effected on the Original Promissory Note subsequent to June 30, 2022.

On October 21, 2021, the Company agreed with 3DOM Alliance Inc. to convert the debt amounting to \$1,547,804 into ordinary shares of the Company at \$100 per share. The Company issued 15,478 shares of ordinary shares on October 22, 2021.

## NOTE 9 - SHAREHOLDERS' EQUITY

On October 22, 2021, the Company issued 309,560 shares of ordinary shares (pre 1:20 share split - 15,478 ordinary shares) to 3DOM Alliance Inc. in connection with the conversion of debt (refer to Note 8).

On April 28, 2022, shareholder of our company and board of directors approved shares split of our issued ordinary shares on a basis of one-for-twenty.

As of June 30, 2022 and 2021, the Company had 311,560 shares (pre 1: 20 share split – 15,578 shares) and 2,000 shares (pre 1: 20 share split – 100 shares) of ordinary shares issued, respectively.

## NOTE 10 – INCOME TAX

noco-noco Pte. Ltd. is incorporated in Singapore, and under the current tax laws of Singapore, its standard corporate income tax rate is 17%.

Due to the Company's net loss position, there was no provision for income taxes recorded.

	June 30, 2022	June 30, 2021
<b>Loss before tax</b>	<u>\$ 1,076,823</u>	<u>\$ 671,811</u>
Tax rate	17%	17%
Computed tax benefit (expense) at statutory tax rate	183,060	114,208
<b>Tax effect of non-deductible or taxable items:</b>		
Additional deduction for R&D expenses	11,680	-
Non-deductible Professional fees	-	(1,213)
Non-taxable Income	-	5,582
Change in valuation allowance	(194,740)	(118,577)
Effect of preferential tax rates	-	-
<b>Income tax expense (benefit)</b>	<u>-</u>	<u>-</u>

The Company evaluates each uncertain tax position (including the potential application of interest and penalties) based on the technical merits, and measure the unrecognized benefits associated with the tax positions. As of June 30, 2022 and 2021, the Company did not have any significant unrecognized uncertain tax positions. The Company did not accrue any liability, interest or penalties related to uncertain tax positions in its provision for income taxes line of its consolidated statements of operations for the years ended June 30, 2022 and 2021. The Company does not believe that its uncertain tax benefits position will materially change over the next twelve months.

As of June 30, 2022, Singapore tax returns for the years 2020 to 2022 are subject to examination by the tax authorities.

Deferred taxes were measured using the enacted tax rates for the periods in which the temporary differences are expected to be reversed. The tax effects of temporary differences that give rise to the deferred tax balances as of June 30, 2022 and 2021 are as follows:

	June 30, 2022	June 30, 2021
<b>Deferred tax assets</b>		
Net operating loss carry-forward	\$ 391,242	\$ 220,900
Capital allowance	3,253	2,627
Lease liabilities	6,185	35,734
Other provisions	22,471	-
Less: valuation allowance	(415,300)	(220,560)
Subtotal	<u>7,851</u>	<u>38,701</u>
<b>Deferred tax liabilities</b>		
Deferred tax liabilities arising from assets	<u>(7,851)</u>	<u>(38,701)</u>
Total deferred tax assets, net	<u>-</u>	<u>-</u>

The Company had net operating loss carried forward for tax purposes of approximately \$2,351,000 as of June 30, 2022 and approximately \$1,275,000 as of June 30, 2021, which may be carried forward to offset future taxable income.

	<u>June 30, 2022</u>	<u>June 30, 2021</u>
<b>The changes related to valuation allowance are as follows:</b>		
Balance at the beginning of the year	\$ 220,560	\$ 101,983
Current year addition	<u>194,740</u>	<u>118,577</u>
Balance at the end of the year	<u><u>415,300</u></u>	<u><u>220,560</u></u>

## NOTE 11 – COMMITMENTS AND CONTINGENCIES

In the normal course of business, we are subject to loss contingencies, such as legal proceedings and claims arising out of our business, that cover a wide range of matters, including, among others, government investigations and tax matters. In accordance with ASC No. 450-20, "Loss Contingencies", we will record accruals for such loss contingencies when it is probable that a liability has been incurred and the amount of loss can be reasonably estimated. In the opinion of management, there were no pending or threatened claims and litigation as of June 30, 2022 and through February 10, 2023, the date the financial statements were available to be issued.

## NOTE 12- SUBSEQUENT EVENTS

In accordance with FASB ASC 855-10 Subsequent Events, the Company has analyzed its operations subsequent to June 30, 2022 to the date these consolidated financial statements were issued, and has determined that there is a material subsequent event to disclose in these consolidated financial statements, because we believe that this event will have a significant effect on the future operations of the Company.

On July 15, 2022, the Company capitalized a debt in the sum of US790,287 from immediate holding company, 3DOM Alliance Inc, into ordinary shares.

The following events are pertaining to a Share Swap Agreement:

- i. On July 19, 2022, the Company entered into a Share Swap Agreement (the "Share Swap") with a carbon abatement management business, Hop2it Holdings Pte. Ltd. ("Hop2it") and its two shareholders, Gregory Hannan and Arun Ramachandran (the "Gregory and Arun"). The principal activities of Hop2it are entirely in carbon sequestration management as an agent for various landowners in Australia, Papua New Guinea and Fiji. In this Share Swap, Gregory and Arun transferred 42% and 10% of their respective Hop2it shares in exchange for 3.2% and 0.8% shares in the Company. This resulted the Company to own 52% interest in Hop2it while the Gregory and Arun own 38% and 10% respectively.
- ii. On August 2, 2022, pursuant to the Share Swap, an aggregate of 13,013 new ordinary shares in the capital of the Company, representing 4% of the Company) is allotted to Gregory and Arun.
- iii. Subsequent to the Share Swap, on December 27, 2022, the Company together with Hop2it, Gregory and Arun entered into a Restructuring Deed as all parties have decided to carry out the carbon abatement management business through a newly incorporated entity, noco-noco Australia Pty Ltd. ("noco-noco Australia"), instead of Hop2it. This was done by the Restructuring Deed specifying that all future potential economic benefits of the carbon abatement management business of Hop2it (represented by the gross proceeds of potential future sales of carbon credits by Hop2it from anticipated issuance of such credits by regulators in Australia and Papua New Guinea; and the expertise and network of potential clients) are to be assigned to noco-noco Australia.
- iv. noco-noco Australia was incorporated on January 19, 2023 with 52% interest held by the Company, 38% and 10% interest held by Gregory and Arun respectively;
- v. As of the date of this management representation letter, there has been no carbon credits issued or sold or contracted to be sold by Hop2it nor by noco-noco Australia. The Company's 52% shares in Hop2it were transferred back to the Gregory and Arun as part of the Restructuring Deed, while the Company's shares that were issued to the Gregory and Arun remains.

On January 23, 2023, 3DOM Alliance Inc. issued an amendment of the Original Promissory Note ("First Amendment to Original Promissory Note") extending the principal amount up to S\$3,000,000 to the Company. There is no other change in terms and conditions to the Original Promissory Note.

On February 2, 2023, the Company requested an additional drawdown of S\$2,980,000 of which 3DOM Alliance Inc. split the amount into two tranches. The Company received S\$1,370,000 on February 3, 2023 and S\$1,610,000 on February 6, 2023.

On February 6, 2023, 3DOM Alliance Inc. further issued an amendment of the Original Promissory Note ("Second Amendment to Original Promissory Note") extending the principal amount up to S\$8,000,000 to the Company. There is no other change in terms and conditions to the Original Promissory Note.



**PRIME NUMBER ACQUISITION I CORP.**  
**UNAUDITED CONDENSED BALANCE SHEETS**

	March 31, 2023	December 31, 2022 (Audited)
<b>Assets</b>		
<b>Current Assets</b>		
Cash	\$ 99,790	\$ 278,295
Prepaid expenses	141,449	125,384
Investments held in Trust Account	67,431,760	66,718,520
Total current assets	67,672,999	67,122,199
<b>Total Assets</b>	<b>\$ 67,672,999</b>	<b>\$ 67,122,199</b>
<b>Liabilities, Redeemable Common Stock and Stockholders' Deficit</b>		
<b>Current Liabilities</b>		
Accounts payable and accrued expenses	\$ 296,076	\$ 90,004
Franchise tax payable	16,600	43,853
Income tax payable	252,469	112,446
Deferred income tax liability	38,619	37,190
Deferred underwriting fee payable	2,257,500	2,257,500
Total current liabilities	2,861,264	2,540,993
<b>Total Liabilities</b>	<b>2,861,264</b>	<b>2,540,993</b>
<b>Commitments and Contingencies</b>		
Common stock subject to possible redemption, 6,450,000 shares at redemption value of \$10.45 and \$10.34 per share as of March 31, 2023 and December 31, 2022, respectively	67,431,760	66,718,520
<b>Stockholders' Deficit</b>		
Preferred stock, \$0.0001 par value; 400,000 shares authorized, none issued or outstanding	—	—
Class A common stock, \$0.0001 par value; 20,000,000 shares authorized; 2,011,392 issued and outstanding (excluding 6,450,000 shares subject to possible redemption)	201	201
Class B common stock, \$0.0001 par value; 100,000 shares authorized; none issued or outstanding	—	—
Additional paid-in capital	—	—
Accumulated deficit	(2,620,226)	(2,137,515)
<b>Total Stockholders' Deficit</b>	<b>(2,620,025)</b>	<b>(2,137,314)</b>
<b>Total Liabilities, Redeemable Common Stock and Stockholders' Deficit</b>	<b>\$ 67,672,999</b>	<b>\$ 67,122,199</b>

The accompanying notes are an integral part of these unaudited condensed financial statements.

**PRIME NUMBER ACQUISITION I CORP.**  
**UNAUDITED CONDENSED STATEMENTS OF OPERATIONS**

	Three Months Ended March 31,	
	2023	2022
General and administrative expenses	\$ 324,659	\$ 9,952
Franchise tax expenses	16,600	—
<b>Loss from operations</b>	<b>(341,259)</b>	<b>(9,952)</b>
Interest earned on investment held in Trust Account	671,159	—
Unrealized gain on investments held in Trust Account	42,081	—
Income (loss) before income taxes	371,981	(9,952)
Income taxes provision	(140,023)	—
Deferred income taxes provision	(1,429)	—
<b>Net income (loss)</b>	<b>\$ 230,529</b>	<b>\$ (9,952)</b>
Basic and diluted weighted average shares outstanding of redeemable common stock	6,450,000	—
Basic and diluted net income per share of redeemable common stock	0.05	—
Basic and diluted weighted average shares outstanding of non-redeemable common stock	2,011,392	1,500,000 <sup>(1)</sup>
Basic and diluted net loss per share of non-redeemable common stock	\$ (0.06)	\$ (0.01)

(1) Excludes up to 225,000 shares of Class A common stock subject to forfeiture to the extent that the underwriters' over-allotment option is not exercised in full or in part (see Note 5). On May 17, 2022, the underwriters partially exercised their over-allotment option and purchased 112,500 shares of Class A common stock. On June 3, 2022, the Sponsors executed cancellation notices to the transfer agent to forfeit the remaining 112,500 shares for no consideration.

The accompanying notes are an integral part of these unaudited condensed financial statements.

**PRIME NUMBER ACQUISITION I CORP.**  
**UNAUDITED CONDENSED STATEMENTS OF CHANGES IN STOCKHOLDER'S EQUITY(DEFICIT)**

	<u>Class A Common Stock</u>		<u>Additional</u>	<u>Accumulated</u>	<u>Total</u>
	<u>Shares</u>	<u>Amount</u>	<u>Paid-in</u> <u>Capital</u>	<u>Deficit</u>	<u>Shareholders'</u> <u>Deficit</u>
<b>Balance as of January 1, 2023</b>	2,011,392	\$ 201	\$ —	\$ (2,137,515)	\$ (2,137,314)
Subsequent measurement of common stock subject to redemption under ASC 480-10-S99 against accumulated deficit	—	—	—	(713,240)	(713,240)
Net income	—	—	—	230,529	230,529
<b>Balance as of March 31, 2023</b>	<u>2,011,392</u>	<u>\$ 201</u>	<u>\$ —</u>	<u>\$ (2,620,226)</u>	<u>\$ (2,620,025)</u>

	<u>Class A Common Stock</u>		<u>Additional</u>	<u>Accumulated</u>	<u>Total</u>
	<u>Shares</u>	<u>Amount</u>	<u>Paid-in</u> <u>Capital</u>	<u>Deficit</u>	<u>Shareholder's</u> <u>Equity</u>
<b>Balance as of January 1, 2022</b>	1,725,000 <sup>(1)</sup>	\$ 173	\$ 24,827	\$ (1,357)	\$ 23,643
Net loss	—	—	—	(9,952)	(9,952)
<b>Balance as of March 31, 2022</b>	<u>1,725,000</u>	<u>\$ 173</u>	<u>\$ 24,827</u>	<u>\$ (11,309)</u>	<u>\$ 13,691</u>

(1) Includes up to 225,000 shares of Class A common stock subject to forfeiture to the extent that the underwriters' over-allotment option is not exercised in full or in part (see Note 5). On May 17, 2022, the underwriters partially exercised their over-allotment option and purchased 112,500 shares of Class A common stock. On June 3, 2022, the Sponsors executed cancellation notices to the transfer agent to forfeit the remaining 112,500 shares for no consideration.

The accompanying notes are an integral part of these unaudited condensed financial statements.

**PRIME NUMBER ACQUISITION I CORP.**  
**UNAUDITED CONDENSED STATEMENTS OF CASH FLOWS**

	<b>Three Months Ended</b>	
	<b>March 31,</b>	
	<b>2023</b>	<b>2022</b>
<b>Cash flows from operating activities:</b>		
Net income (loss)	\$ 230,529	\$ (9,952)
Adjustments to reconcile net cash used in operating activities:		
Interest earned on investment held in Trust Account	(671,159)	—
Unrealized gain on investments held in Trust Account	(42,081)	—
Deferred income tax	1,429	—
Changes in operating assets and liabilities:		
Prepaid expenses	(16,065)	—
Accounts payable and accrued expenses	206,072	5,547
Franchise tax payable	(27,253)	—
Income tax payable	140,023	—
<b>Net cash used in operating activities</b>	<b>(178,505)</b>	<b>(4,405)</b>
<b>Cash Flows from Financing Activities:</b>		
Payment of deferred offering costs	—	(12,846)
<b>Net cash provided by financing activities</b>	<b>—</b>	<b>(12,846)</b>
<b>Net change in cash</b>	<b>(178,505)</b>	<b>(17,251)</b>
<b>Cash, beginning of the period</b>	<b>278,295</b>	<b>125,303</b>
<b>Cash, end of the period</b>	<b>\$ 99,790</b>	<b>\$ 108,052</b>
<b>Supplemental Disclosure of Non-cash Financing Activities</b>		
Subsequent measurement of common stock to redemption value	\$ 713,240	\$ —
Deferred offering costs in accrued offering expenses	\$ —	\$ 51,285

The accompanying notes are an integral part of these unaudited condensed financial statements.

**PRIME NUMBER ACQUISITION I CORP.**  
**NOTES TO UNAUDITED CONDENSED FINANCIAL STATEMENTS**

**Note 1 — Description of Organization and Business Operations**

Prime Number Acquisition I Corp. (the “Company”) is a blank check company incorporated as a Delaware corporation on February 25, 2021. The Company was formed for the purpose of effecting a merger, share exchange, asset acquisition, share purchase, reorganization or similar business combination with one or more businesses or entities (the “initial business combination”). The Company is an early stage and emerging growth company and, as such, it is subject to all of the risks associated with early stage and emerging growth companies.

As of March 31, 2023, the Company had not commenced any operations. Activities before May 17, 2022 are related to the formation and IPO, while the activities after May 17, 2022 are mainly focused on searching and identifying the Initial business combination target. The Company will not generate any operating revenues until after the completion of an initial business combination, at the earliest. The Company will generate non-operating income in the form of interest income from the proceeds derived from the IPO. The Company has selected December 31 as its fiscal year end.

The Company’s sponsors are Prime Number Acquisition LLC (“Sponsor A”) and Glorious Capital LLC (“Sponsor B”) (collectively the “Sponsors”), both are Delaware limited liability companies.

The registration statement for the Company’s IPO became effective on May 12, 2022. On May 17, 2022, the Company consummated the initial public offering (the “IPO”) of 6,450,000 units (the “Public Units”) which included 450,000 units issued upon the partial exercise of the underwriters’ over-allotment option. The Public Units were sold at an offering price of \$10.00 per unit, with each Public Unit consists of one share (the “Public Shares”) of the Company’s Class A common stock (the “Class A common stock”), one half of one warrant, and one right, generating gross proceeds of \$64,500,000. Simultaneously with the IPO, the Company completed the private sale of 398,892 shares of the Class A common stock (the “Private Shares”) to the Company’s Sponsors, including 349,032 shares to Sponsor A and 49,860 shares to Sponsor B, at a purchase price of \$10.00 per Private Share, generating gross proceeds of \$3,988,920 (including \$3,490,320 from Sponsor A and \$498,600 from Sponsor B), which is described in Note 4.

Upon the closing of the IPO and the private placement on May 17, 2022, the proceeds of \$65,790,000 (or \$10.20 per Public Unit) in the aggregate from the IPO and the private placement were placed in a trust account (the “Trust Account” as defined in Note 5) with Wilmington Trust, N.A. acting as trustee and will be invested only in U.S. government treasury bills with a maturity of 185 days or less or in money market funds meeting certain conditions under Rule 2a-7 under the Investment Company Act of 1940, as amended (the “Investment Company Act”), and that invest only in direct U.S. government treasury obligations. These funds will not be released until the earlier of the completion of the initial business combination or the liquidation due to the Company’s failure to complete an initial business combination within the applicable period of time. The proceeds deposited in the Trust Account could become subject to the claims of the Company’s creditors, if any, which could have priority over the claims of the Company’s holders of its outstanding Public Shares (the “Public Stockholders”). In addition, interest income earned on the funds in the Trust Account may be released to the Company to pay its income or other tax obligations. With these exceptions, expenses incurred by the Company may be paid prior to an Initial business combination only from the net proceeds of the IPO and private placement not held in the Trust Account.

Pursuant to Nasdaq listing rules, the Company’s initial business combination must occur with one or more target businesses having an aggregate fair market value equal to at least 80% of the value of the funds in the Trust Account (excluding any deferred underwriting discounts and commissions and taxes payable on the income earned on the Trust Account), which the Company refers to as the 80% test, at the time of the execution of a definitive agreement for its initial business combination, although the Company may structure an initial business combination with one or more target businesses whose fair market value significantly exceeds 80% of the Trust Account balance. If the Company is no longer listed on Nasdaq, it will not be required to satisfy the 80% test. The Company will only complete an initial business combination if the post-transaction company owns or acquires 50% or more of the outstanding voting securities of the target or otherwise acquires a controlling interest in the target sufficient for it not to be required to register as an investment company under the Investment Company Act.

The Company will provide its holders of the outstanding Public Shares with the opportunity to redeem all or a portion of their Public Shares upon the completion of an initial business combination either (i) in connection with a stockholder meeting called to approve the initial business combination or (ii) by means of a tender offer. The decision as to whether the Company will seek stockholder approval of an initial business combination or conduct a tender offer will be made by the Company. The Public Stockholders will be entitled to redeem their Public Shares for a pro rata portion of the amount then in the Trust Account (initially anticipated to be \$10.20 per Public Share, plus any pro rata interest earned on the funds held in the Trust Account and not previously released to the Company) to pay its franchise and income tax obligations.

If a stockholder vote is not required by law and the Company does not decide to hold a stockholder vote for business or other legal reasons, the Company will, pursuant to its Amended and Restated Certificate of Incorporation (the “Amended and Restated Certificate of Incorporation”), conduct the redemptions pursuant to the tender offer rules of the U.S. Securities and Exchange Commission (“SEC”) and file tender offer documents with the SEC prior to completing an initial business combination. If, however, stockholder approval of the transaction is required by law, or the Company decides to obtain stockholder approval for business or legal reasons, the Company will offer to redeem shares in conjunction with a proxy solicitation pursuant to the proxy rules and not pursuant to the tender offer rules. Additionally, each public stockholder may elect to redeem their Public Shares irrespective of whether they vote for or against the proposed transaction. If the Company seeks stockholder approval in connection with an initial business combination, the Company’s Sponsors and any of the Company’s officers or directors that may hold Founder Shares (as defined in Note 5) (the “Initial Stockholders”) have agreed (a) to vote their Founder Shares, the Private Shares, and any Public Shares purchased during or after the IPO in favor of approving an initial business combination and (b) not to convert any shares (including the Founder Shares) in connection with a stockholder vote to approve, or sell the shares to the Company in any tender offer in connection with, a proposed initial business combination.

The Company’s Initial Stockholders have agreed (A) to vote their Founder Shares, Private Shares and any Public Shares they own in favor of any proposed initial business combination, (B) not to propose, or vote in favor of, prior to and unrelated to an initial business combination, an amendment to the Company’s certificate of incorporation that would affect the substance or timing of the Company’s redemption obligation to redeem all public shares if the Company cannot complete an initial business combination within the Combination Period (as defined below), unless the Company provides Public Stockholders an opportunity to redeem their public shares in conjunction with any such amendment, (C) not to redeem any shares, including Founder Shares, Private Shares and any Public Shares they own into the right to receive cash from the Trust Account in connection with a stockholder vote to approve the Company’s proposed initial business combination or sell any shares to the Company in any tender offer in connection with its proposed initial business combination, and (D) that the Founder Shares and Private Shares shall not participate in any liquidating distribution upon winding up if an initial business combination is not consummated.

If the Company seeks stockholder approval of an initial business combination and it does not conduct redemptions pursuant to the tender offer rules, the Amended and Restated Certificate of Incorporation provides that a public stockholder, together with any affiliate of such stockholder or any other person with whom such stockholder is acting in concert or as a “group” (as defined under Section 13 of the Securities Exchange Act of 1934, as amended (the “Exchange Act”)), will be restricted from redeeming its shares with respect to more than an aggregate of 15% of the shares sold the IPO.

The Initial Stockholders and underwriters have agreed (a) to waive their redemption rights with respect to the Founder Shares, Private Shares, and Public Shares held by them in connection with the completion of an initial business combination and (b) not to propose, or vote in favor of, an amendment to the Amended and Restated Certificate of Incorporation that would affect the substance or timing of the Company’s obligation to redeem 100% of its Public Shares if the Company does not complete an initial business combination, unless the Company provides the public stockholders with the opportunity to redeem their Public Shares in conjunction with any such amendment.

Under the Company’s then effective Amended and Restated Certificate of Incorporation, the Company would have until May 17, 2023 (or November 17, 2023 if the Company extends the period of time to consummate an initial business combination) to consummate an initial business combination. On May 15, 2023, the Company held a special meeting of stockholders (the “Special Meeting”). At the Special Meeting, the stockholders of the Company approved the proposal to amend the Company’s then effective Amended and Restated Certificate of Incorporation to (i) allow the Company until May 17, 2023 to consummate an initial business combination, and to (ii) elect to extend the period to consummate an initial business combination up to six times, each by an additional one-month period, for a total of up to six months to November 17, 2023 (“Extended Termination Date”), by depositing to the Company’s Trust Account the amount lesser of (i) \$125,000 for each one-month extension or (ii) \$0.045 for each Public Share for each one-month extension (the “Extension Amendment Proposal”). Upon the stockholders’ approval, on May 17, 2023, the Company filed a certificate of amendment (the “Charter”) to the then effective Amended and Restated Certificate of Incorporation which became effective upon filing on the same date, pursuant to which, the Company may elect to extend the period to consummate an initial business combination up to six times, each by an additional one-month period (each, a “Monthly Extension”), for a total of up to six months to November 17, 2023, by depositing to the Trust Account \$125,000 for each one-month extension.

In connection with the votes to approve the Extension Amendment Proposal, 1,537,701 Public Shares of the Company were tendered for redemption. As of the date of this proxy statement/prospectus, all such Public Shares are in the process of redemption by our transfer agent, VStock Transfer, LLC, which shall result in a total of 4,912,299 Public Shares, or 6,923,691 Class A Common Stock remaining after the consummation of such process.

On May 17, 2023, an aggregate of \$125,000 was deposited into the Trust Account for the public stockholders, resulting in an extension of the period of time we have to consummate the initial business combination by one month from May 17, 2023 to June 17, 2023 (the “First Monthly Extension”).

Under the Company's Charter effective on May 17, 2023 and after the Extension, the Company would now have until June 17, 2023 (or November 17, 2023 if the Company extends the period of time to consummate an initial business combination) to consummate an initial business combination (the "Combination Period").

If the Company is unable to complete an initial business combination within the Combination Period, the Company will (i) cease all operations except for the purpose of winding up, (ii) as promptly as reasonably possible but not more than ten business days thereafter, redeem the Public Shares, at a per-share price, payable in cash, equal to the aggregate amount then on deposit in the Trust Account including interest (which interest shall be net of taxes payable, and less interest to pay dissolution expenses) divided by the number of then outstanding Public Shares, which redemption will completely extinguish public stockholders' rights as stockholders (including the right to receive further liquidating distributions, if any), subject to applicable law, and (iii) as promptly as reasonably possible following such redemption, subject to the approval of the Company's remaining stockholders and the Company's board of directors, dissolve and liquidate, subject in each case to the Company's obligations under Delaware law to provide for claims of creditors and the requirements of other applicable law.

The Initial Stockholders have agreed to waive their liquidation rights with respect to the Founder Shares and Private Shares if the Company fails to complete an initial business combination within the Combination Period. However, if the Initial Stockholders acquire Public Shares in or after the IPO, such Public Shares will be entitled to liquidating distributions from the Trust Account if the Company fails to complete an initial business combination within the Combination Period. The Underwriters (as defined in Note 5) have agreed to waive their rights to their Deferred Underwriting Commissions (see Note 6) held in the Trust Account in the event the Company does not complete an initial business combination within the Combination Period and, in such event, such amounts will be included with the other funds held in the Trust Account that will be available to fund the redemption of the Public Shares. In the event of such distribution, it is possible that the per share value of the assets remaining available for distribution will be less than \$10.20.

In order to protect the amounts held in the Trust Account, the Sponsors have agreed to be liable to the Company if and to the extent any claims by a third party for services rendered or products sold to the Company, or a prospective target business with which the Company has discussed entering into a transaction agreement, reduce the amount of funds in the Trust Account to below (i) \$10.20 per Public Share or (ii) such lesser amount per Public Share held in the Trust Account as of the date of the liquidation of the Trust Account, due to reductions in value of the trust assets, in each case net of the amount of interest which may be withdrawn to pay taxes, except as to any claims by a third party who executed a waiver of any and all rights to seek access to the Trust Account and except as to any claims under our indemnity of the Underwriters of this IPO against certain liabilities, including liabilities under the Securities Act. In the event that an executed waiver is deemed to be unenforceable against a third party, then the Sponsors will not be responsible to the extent of any liability for such third party claims.

On December 29, 2022, the Company, Prime Number Merger Sub Inc. ("Merger Sub"), a Delaware corporation, NOCO-NOCO PTE. LTD ("noco-noco"), a Singapore private company limited by shares, and certain shareholders of noco-noco ("Sellers") entered into the Business Combination Agreement ("the Business Combination Agreement"), pursuant to which, (i) the Company shall merge with and into Merger Sub, with the Company being the surviving company and a wholly owned subsidiary of PubCo, a Cayman Islands company to be formed pursuant to the Business Combination Agreement, and (ii) following the merger, New SubCo, a Singapore private company to be formed pursuant to the Business Combination Agreement, will acquire all of the issued and outstanding shares of the Sellers, in exchange for PubCo to issue to the Sellers PubCo Ordinary Shares. Collectively, all the transactions provided in the Business Combination Agreement shall be referred as the Business Combination.

On February 2, 2023, Prime Number Holding Limited, formed as the PubCo on December 28, 2022, and Prime Number New Sub Pte. Ltd., formed as New SubCo on January 25, 2023, joined as parties to the Business Combination Agreement.

On May 17, 2023, the registration statement on Form F-4 was submitted to the SEC regarding the proposed Business Combination between the Company and noco-noco.

#### **Going Concern**

As of March 31, 2023, the Company had cash of \$99,790 and a working capital deficit of \$54,837 (excluding investments held in trust account, deferred underwriting fee payable, deferred income tax liability and taxes payable). The Company's liquidity needs up to the closing of the IPO on May 17, 2022 had been satisfied through proceeds from notes payable and advances from a related party and from the issuance of common stock.

On May 15, 2023, the Company's stockholders approved an amendment to the Company's Amended and Restated Certificate of Incorporation to allow an extension to November 17, 2023 on a month-by-month basis. On May 17, 2023, the Company deposited \$125,000 into the Trust Account to extend time to consummate the business combination by one month to June 17, 2023. It is uncertain that the Company will be able to consummate an initial business combination by this time. If an initial business combination is not consummated by this date, there will be a mandatory liquidation and subsequent dissolution.

In order to finance transaction costs in connection with an initial business combination, the Company's Sponsors or an affiliate of the Sponsors or certain of the Company's officers and directors may, but are not obligated to, provide the Company with working capital. The Company's management plans to continue its efforts to complete an initial business combination within the Combination Period.

If the estimated costs of identifying a target business, undertaking in-depth due diligence and negotiating an initial business combination are less than the actual amount necessary to do so, the Company may have insufficient funds available to operate its business prior to its initial business combination. Moreover, the Company may need to obtain additional financing either to complete its initial business combination or because it becomes obligated to redeem a significant number of public shares upon consummation of its initial business combination, in which case the Company may issue additional securities or incur debt in connection with such initial business combination. Subject to compliance with applicable securities laws, the Company would only complete such financing simultaneously with the completion of our initial business combination.

In connection with the Company's assessment of going concern considerations in accordance with FASB ASC Topic 205-40, "Presentation of Financial Statements — Going Concern," management has determined that mandatory liquidation, should an initial business combination not occur, and potential subsequent dissolution raises substantial doubt about the Company's ability to continue as a going concern for a reasonable period of time, which is considered to be one year from the issuance of the financial statements.

#### Risks and Uncertainties

Management is currently evaluating the impact of the COVID-19 pandemic on the industry and has concluded that while it is reasonably possible that the virus could have a negative effect on the Company's future financial position, results of its operations and/or search for a target company, there has not been a significant impact as of the date of these financial statements. The financial statements do not include any adjustments that might result from the future outcome of this uncertainty.

Additionally, as a result of the military action commenced in February 2022 by the Russian Federation and Belarus in the country of Ukraine and related economic sanctions, the Company's ability to consummate an initial business combination, or the operations of a target business with which the Company ultimately consummates an initial business combination, may be materially and adversely affected. In addition, the Company's ability to consummate a transaction may be dependent on the ability to raise equity and debt financing which may be impacted by these events, including as a result of increased market volatility, or decreased market liquidity in third-party financing being unavailable on terms acceptable to the Company or at all. The impact of this action and related sanctions on the world economy and the specific impact on the Company's financial position, results of operations and/or ability to consummate an initial business combination are not yet determinable. The financial statements do not include any adjustments that might result from the outcome of this uncertainty.

On August 16, 2022, the Inflation Reduction Act of 2022 (the "IR Act") was signed into federal law. The IR Act provides for, among other things, a new U.S. federal 1% excise tax on certain repurchases (including redemptions) of stock by publicly traded domestic (i.e., U.S.) corporations and certain domestic subsidiaries of publicly traded foreign corporations. The excise tax is imposed on the repurchasing corporation itself, not its shareholders from which shares are repurchased. The amount of the excise tax is generally 1% of the fair market value of the shares repurchased at the time of the repurchase. However, for purposes of calculating the excise tax, repurchasing corporations are permitted to net the fair market value of certain new stock issuances against the fair market value of stock repurchases during the same taxable year. In addition, certain exceptions apply to the excise tax. The U.S. Department of the Treasury (the "Treasury") has been given authority to provide regulations and other guidance to carry out and prevent the abuse or avoidance of the excise tax. The IR Act applies only to repurchases that occur after December 31, 2022.

Any redemption or other repurchase that occurs after December 31, 2022, in connection with an initial business combination, extension vote or otherwise, may be subject to the excise tax. Whether and to what extent the Company would be subject to the excise tax in connection with an initial business combination, extension vote or otherwise would depend on a number of factors, including (i) the fair market value of the redemptions and repurchases in connection with the initial business combination, extension or otherwise, (ii) the structure of an initial business combination, (iii) the nature and amount of any "PIPE" or other equity issuances in connection with an initial business combination (or otherwise issued not in connection with an initial business combination but issued within the same taxable year of an initial business combination) and (iv) the content of regulations and other guidance from the Treasury. In addition, because the excise tax would be payable by the Company and not by the redeeming holder, the mechanics of any required payment of the excise tax have not been determined; however, the Company will not use the funds held in the Trust Account or any additional amounts deposited into the Trust Account, as well as any interest earned thereon, to pay the excise tax, if any. The foregoing could cause a reduction in the cash available on hand to complete an initial business combination and in the Company's ability to complete an initial business combination.



## **Note 2 — Significant Accounting Policies**

### **Basis of Presentation**

The accompanying unaudited condensed financial statements are presented in conformity with accounting principles generally accepted in the United States of America (“GAAP”) and pursuant to the rules and regulations of the SEC. Accordingly, they include all of the information and footnotes required by GAAP. In the opinion of management, all adjustments (consisting of normal accruals) considered for a fair presentation have been included.

These unaudited condensed financial statements should be read in conjunction with the Company’s audited financial statements and the notes thereto included in the Annual Report for the year ended December 31, 2022, which are included in Form 10-K filed on April 3, 2023.

### **Emerging Growth Company**

The Company is an “emerging growth company,” as defined in Section 2(a) of the Securities Act, as modified by the Jumpstart Our Business Startups Act of 2012 (the “JOBS Act”), and it may take advantage of certain exemptions from various reporting requirements that are applicable to other public companies that are not emerging growth companies including, but not limited to, not being required to comply with the independent registered public accounting firm attestation requirements of Section 404 of the Sarbanes-Oxley Act of 2002, reduced disclosure obligations regarding executive compensation in its periodic reports and proxy statements, and exemptions from the requirements of holding a nonbinding advisory vote on executive compensation and stockholder approval of any golden parachute payments not previously approved.

Further, Section 102(b)(1) of the JOBS Act exempts emerging growth companies from being required to comply with new or revised financial accounting standards until private companies (that is, those that have not had a Securities Act registration statement declared effective or do not have a class of securities registered under the Exchange Act) are required to comply with the new or revised financial accounting standards. The JOBS Act provides that a company can elect to opt out of the extended transition period and comply with the requirements that apply to non-emerging growth companies but any such election to opt out is irrevocable. The Company has elected not to opt out of such extended transition period which means that when a standard is issued or revised and it has different application dates for public or private companies, the Company, as an emerging growth company, can adopt the new or revised standard at the time private companies adopt the new or revised standard. This may make comparison of the Company’s financial statements with another public company that is neither an emerging growth company nor an emerging growth company that has opted out of using the extended transition period difficult or impossible because of the potential differences in accounting standards used.

### **Use of Estimates**

In preparing these financial statements in conformity with U.S. GAAP, the Company’s management makes estimates and assumptions that affect the reported amounts of assets and liabilities and disclosure of contingent assets and liabilities at the date of the financial statements and the reported expenses during the reporting period.

Making estimates requires management to exercise significant judgment. It is at least reasonably possible that the estimate of the effect of a condition, situation or set of circumstances that existed at the date of the financial statements, which management considered in formulating its estimate, could change in the near term due to one or more future confirming events. Accordingly, the actual results could differ significantly from those estimates.

### **Cash and Cash Equivalents**

The Company considers all short-term investments with an original maturity of three months or less when purchased to be cash equivalents. The Company had \$99,790 and \$278,295 in cash as of March 31, 2023 and December 31, 2022, respectively, and none in cash equivalents for both periods.

### **Investments Held in Trust Account**

As of March 31, 2023, the assets held in the Trust Account were held in cash and U.S. Treasury securities. The Company classifies its U.S. Treasury securities as trading securities in accordance with Financial Accounting Standards Board (“FASB”) Accounting Standards Codification (“ASC”) Topic 320, “Investments—Debt and Equity Securities.” Trading securities are presented on the balance sheets at fair value at the end of each reporting period. Gains and losses resulting from the change in fair value of these securities is included in gain on investments held in Trust Account in the accompanying statement of operations. The estimated fair values of all assets held in the Trust Account are determined using available market information and classified as Level 1 measurements.

## Offering Costs Associated with the IPO

The Company complies with the requirements of Financial Accounting Standards Board (the “FASB”) Accounting Standards Codification (the “ASC”) Topic 340-10-S99-1, “Other Assets and Deferred Costs – SEC Materials” (“ASC 340-10-S99”) and SEC Staff Accounting Bulletin Topic 5A, “Expenses of Offering”. Deferred offering costs were \$4,117,889 consisting principally of underwriting, legal, accounting and other expenses that are directly related to the IPO and charged to stockholders’ equity upon the completion of the IPO.

Upon completion of the IPO, offering costs were allocated to the separable financial instruments issued in the IPO based on a relative fair value basis, compared to total proceeds received. Offering costs allocated to the warrants and rights were charged to equity. Offering costs allocated to the common stocks were charged against the carrying value of common stocks subject to possible redemption upon the completion of the IPO.

## Income Taxes

The Company accounts for income taxes under ASC 740, “Income Taxes.” ASC 740, Income Taxes, requires the recognition of deferred tax assets and liabilities for both the expected impact of differences between the unaudited condensed financial statements and tax basis of assets and liabilities and for the expected future tax benefit to be derived from tax loss and tax credit carry forwards. ASC 740 additionally requires a valuation allowance to be established when it is more likely than not that all or a portion of deferred tax assets will not be realized.

ASC 740 -270-25-2 requires that an annual effective tax rate be determined and such annual effective rate applied to year to date income in interim periods under ASC 740-270-30-5. The Company’s effective tax rate was 36.61% and 0.00% for the three months ended March 31, 2023 and 2022, respectively. The effective tax rate differs from the statutory tax rate of 21% for the three months ended March 31, 2023 and 2022 primarily due to the non-deductible transaction costs.

ASC 740 also clarifies the accounting for uncertainty in income taxes recognized in an enterprise’s financial statements and prescribes a recognition threshold and measurement process for financial statement recognition and measurement of a tax position taken or expected to be taken in a tax return. For those benefits to be recognized, a tax position must be more-likely-than-not to be sustained upon examination by taxing authorities. ASC 740 also provides guidance on derecognition, classification, interest and penalties, accounting in interim period, disclosure and transition.

The Company recognizes accrued interest and penalties related to unrecognized tax benefits as income tax expense. There were no unrecognized tax benefits and no amounts accrued for interest and penalties as of March 31, 2023 and December 31, 2022. The Company is currently not aware of any issues under review that could result in significant payments, accruals or material deviation from its position.

The Company has identified the United States as its only “major” tax jurisdiction.

The Company may be subject to potential examination by federal and state taxing authorities in the areas of income taxes. These potential examinations may include questioning the timing and amount of deductions, the nexus of income among various tax jurisdictions and compliance with federal and state tax laws. The Company’s management does not expect that the total amount of unrecognized tax benefits will materially change over the next twelve months.

## Net Income (Loss) Per Share

Net income (loss) per share is computed by dividing net income (loss) by the weighted average number of shares of common stock outstanding during the period, excluding shares of common stock subject to forfeiture by the Initial Stockholders. Weighted average shares were reduced for the effect of the forfeiture of 112,500 Founder Shares as a result of the Underwriters’ partial exercise of their over-allotment option on May 17, 2022. On June 3, 2022, the Sponsors executed cancellation notices to the transfer agent to forfeit the remaining 112,500 shares for no consideration. The calculation of diluted net income (loss) per share and related weighted average of the shares does not consider the effect of the warrants and rights issued in connection with the (i) IPO, and (ii) the private placement since the exercise of the warrants and rights are contingent upon the occurrence of future events. The warrants are exercisable to purchase 3,225,000 shares of Class A Common Stock in the aggregate, and the rights are exercisable to convert 806,250 shares of Class A Common Stock in the aggregate. At March 31, 2023, the Company did not have any dilutive securities and other contracts that could, potentially, be exercised or converted into shares of common stock and then share in the earnings of the Company. As a result, diluted income (loss) per share is the same as basic loss per share for the period presented.

The net income (loss) per share presented in the statements of operations is based on the following:

	<b>Three Months Ended March 31,</b>				
	<b>2023</b>		<b>2022</b>		
Net income (loss)	\$	230,529	\$	(9,952)	
Subsequent measurement of common stock subject to redemption value		(713,240)		—	
Net loss including accretion of common stock to redemption value	\$	<u>(482,711)</u>	\$	<u>(9,952)</u>	
		<b>For the Three Months Ended March 31, 2023</b>		<b>For the Three Months Ended March 31, 2022</b>	
		<b>Redeemable shares</b>	<b>Non- redeemable shares</b>	<b>Redeemable shares</b>	<b>Non- redeemable shares</b>
Basic and diluted net income (loss) per common stock					
Numerator:					
Allocation of net loss including accretion of common stock	\$	(367,964)	\$	(114,747)	\$ (9,952)
Subsequent measurement of common stock subject to redemption value		713,240		—	—
Allocation of net income (loss)	\$	<u>345,276</u>	\$	<u>(114,747)</u>	\$ (9,952)
Denominator:					
Basic and diluted weighted average shares outstanding		6,450,000		2,011,392	— 1,500,000
Basic and diluted net income (loss) per common stock	\$	<u>0.05</u>	\$	<u>(0.06)</u>	<u>(0.01)</u>

#### Concentration of Credit Risk

Financial instruments that potentially subject the Company to concentrations of credit risk consist of a cash account in a financial institution, which, at times, may exceed the Federal Depository Insurance Coverage of \$250,000. As of March 31, 2023 and December 31, 2022, the Company has not experienced losses on this account and management believes the Company is not exposed to significant risks on such account.

#### Fair Value of Financial Instruments

The fair value of the Company's assets and liabilities, which qualify as financial instruments under ASC 825, "Financial Instruments," approximates the carrying amounts represented in the accompanying balance sheet, primarily due to their short-term nature.

#### Warrants

The Company accounts for warrants as either equity-classified or liability-classified instruments based on an assessment of the warrant's specific terms and applicable authoritative guidance in FASB ASC 480, Distinguishing Liabilities from Equity ("ASC 480") and ASC 815, Derivatives and Hedging ("ASC 815"). The assessment considers whether the warrants are freestanding financial instruments pursuant to ASC 480, meet the definition of a liability pursuant to ASC 480, and whether the warrants meet all of the requirements for equity classification under ASC 815, including whether the warrants are indexed to the Company's own common shares and whether the warrant holders could potentially require "net cash settlement" in a circumstance outside of the Company's control, among other conditions for equity classification. This assessment, which requires the use of professional judgment, is conducted at the time of warrant issuance and as of each subsequent quarterly period end date while the warrants are outstanding. The Company determined that upon further review of the warrant agreement, the Public Warrants issued pursuant to the warrant agreement qualify for equity accounting treatment.

For issued or modified warrants that meet all of the criteria for equity classification, the warrants are required to be recorded as a component of equity at the time of issuance. For issued or modified warrants that do not meet all the criteria for equity classification, the warrants are required to be recorded as liabilities at their initial fair value on the date of issuance, and each balance sheet date thereafter. Changes in the estimated fair value of the warrants are recognized as a non-cash gain or loss on the statements of operations.

## Common Stock Subject to Possible Redemption

The Company accounts for its common stock subject to possible redemption in accordance with the guidance in ASC Topic 480 “Distinguishing Liabilities from Equity.” Common stock subject to mandatory redemption (if any) are classified as a liability instrument and are measured at fair value. Conditionally redeemable common stock (including common stock that feature redemption rights that is either within the control of the holder or subject to redemption upon the occurrence of uncertain events not solely within the Company’s control) is classified as temporary equity. At all other times, common stock is classified as stockholders’ equity. The Company’s common stock features certain redemption rights that are considered to be outside of the Company’s control and subject to occurrence of uncertain future events. Accordingly, as of March 31, 2023 and December 31, 2022, common stock subject to possible redemption are presented at redemption value of \$10.45 and \$10.34 per share as temporary equity, respectively, outside of the shareholders’ equity section of the Company’s balance sheet. The Company recognizes changes in redemption value immediately as they occur and adjusts the carrying value of redeemable common stock to equal the redemption value at the end of each reporting period. Increases or decreases in the carrying amount of shares of redeemable common stock are affected by charges against additional paid in capital or accumulated deficit if additional paid in capital equals to zero.

## Recent Accounting Pronouncements

In August 2020, FASB issued Accounting Standards Update (“ASU”) 2020-06, Debt — Debt with Conversion and Other Options (Subtopic 470-20) and Derivatives and Hedging — Contracts in Entity’s Own Equity (Subtopic 815-40) (“ASU 2020-06”) to simplify accounting for certain financial instruments. ASU 2020-06 eliminates the current models that require separation of beneficial conversion and cash conversion features from convertible instruments and simplifies the derivative scope exception guidance pertaining to equity classification of contracts in an entity’s own equity. The new standard also introduces additional disclosures for convertible debt and freestanding instruments that are indexed to and settled in an entity’s own equity. ASU 2020-06 amends the diluted earnings per share guidance, including the requirement to use the if-converted method for all convertible instruments. ASU 2020-06 is effective January 1, 2024 for the Company and should be applied on a full or modified retrospective basis, with early adoption permitted beginning on January 1, 2021. The Company is currently assessing the impact, if any, that ASU 2020-06 would have on its financial position, results of operations or cash flows.

Management does not believe that any other recently issued, but not yet effective, accounting pronouncements, if currently adopted, would have a material effect on the Company’s financial statement.

## Note 3 — Initial Public Offering

Pursuant to the IPO on May 17, 2022, the Company sold 6,450,000 Public Units which included 450,000 units issued upon the partial exercise of the underwriters’ over-allotment option. Each Public Unit consists of one share of Class A common stock, \$0.0001 par value per share, one-half of one redeemable warrant (the “Public Warrants”), each whole Public Warrant entitling the holder thereof to purchase one share of Class A Common Stock at an exercise price of \$11.50 per share, and one right (the “Public Rights”), each one Public Right entitling the holder thereof to exchange for one-eighth (1/8) of one Class A Common Stock upon the completion of the Company’s initial business combination. Because the Warrants may only be exercised for whole numbers of shares, only an even number of Warrants may be exercised. The Warrants will become exercisable on the later of 30 days after the completion of the Company’s initial business combination or 12 months from the closing of the IPO, and will expire five years after the completion of the Company’s initial business combination or earlier upon redemption or liquidation. Each Right entitles the holder thereof to receive one-eighth (1/8) of one share of Class A common stock at the closing of an initial business combination. The Company will not issue fractional shares in connection with an exchange of Rights. Fractional shares will either be rounded down to the nearest whole share or otherwise addressed in accordance with the applicable provisions of the Delaware General Corporation Law, or DGCL. As a result, the holder of the Rights must hold Rights in multiples of eight (8) in order to receive shares of Class A common stock for all of their rights upon closing of an initial business combination.

All of the 6,450,000 Public Shares sold as part of the Public Units in the IPO contain a redemption feature which allows for the redemption of such Public Shares if there is a stockholder vote or tender offer in connection with the initial business combination and in connection with certain amendments to the Company’s amended and restated certificate of incorporation, or in connection with the Company’s liquidation. In accordance with the SEC and its staff’s guidance on redeemable equity instruments, which has been codified in ASC 480-10-S99, redemption provisions not solely within the control of the Company require common stock subject to redemption to be classified outside of permanent equity.

The Company's redeemable Class A common stock is subject to SEC and its staff's guidance on redeemable equity instruments, which has been codified in ASC 480-10-S99. If it is probable that the equity instrument will become redeemable, the Company has the option to either accrete changes in the redemption value over the period from the date of issuance (or from the date that it becomes probable that the instrument will become redeemable, if later) to the earliest redemption date of the instrument or to recognize changes in the redemption value immediately as they occur and adjust the carrying amount of the instrument to equal the redemption value at the end of each reporting period. The Company has elected to recognize the changes immediately. The accretion or remeasurement is treated as a deemed dividend (i.e., a reduction to retained earnings, or in absence of retained earnings, additional paid-in capital).

As of March 31, 2023, the shares of Class A common stock reflected on the balance sheet are reconciled in the following table.

	<b>As of</b>
	<b>March 31, 2023</b>
Gross proceeds	\$ 64,500,000
Less:	
Proceeds allocated to Public Warrants	(322,500)
Proceeds allocated to Public Rights	(5,160,000)
Offering costs of Public Shares	(3,767,868)
Plus:	
Accretion of carrying value to redemption value	11,468,889
Common stock subject to possible redemption - December 31, 2022	66,718,520
Plus:	
Accretion of carrying value to redemption value - three months ended March 31, 2023	713,240
Common stock subject to possible redemption - March 31, 2023	<u>\$ 67,431,760</u>

#### **Note 4 — Private Placement**

Simultaneously with the closing of the IPO, the Company sold an aggregate of 398,892 Private Shares, including 349,032 shares to Sponsor A and 49,860 shares to Sponsor B, at a purchase price of \$10.00 per Private Share, generating gross proceeds of \$3,988,920 (including \$3,490,320 from Sponsor A and \$498,600 from Sponsor B). The net proceeds from the Private Shares were added to the proceeds from the IPO to be held in the Trust Account. If the Company does not complete an initial business combination within the Combination Period, the proceeds from the sale of the Private Shares will be used to fund the redemption of the Public Shares (subject to the requirements of applicable law), and the Private Share will expire worthless.

#### **Note 5 — Related Party Transactions**

##### **Promissory Note - Related Party**

On March 19, 2021, Sponsor A agreed to loan the Company up to an aggregate amount of \$400,000 to be used, in part, for transaction costs incurred in connection with IPO (the "Promissory Note"). The Promissory Note is unsecured, interest-free and due at the earlier of August 31, 2022 or closing of the IPO. The Company repaid the \$350,000 outstanding balance upon the closing of the IPO on May 17, 2022.

##### **Related Party Loans**

In addition, in order to finance transaction costs in connection with an intended initial business combination, the Initial Stockholders or their affiliates may, but are not obligated to, loan us funds as may be required. If the Company completes an initial business combination, it would repay such loaned amounts (the "Working Capital Loans"). In the event that the initial business combination does not close, the Company may use a portion of the working capital held outside the U.S. based Trust Account to repay such loaned amounts but no proceeds from our Trust Account would be used for such repayment. Certain amount of such loans may be convertible into working capital shares at \$10.00 per share at the option of the lender. The working capital shares would be identical to the shares sold in the private placement. As of March 31, 2023, the Company had no borrowings under the Working Capital Loans.

On April 23, 2023, DBG Global Limited, a member of Sponsor A, agreed to loan the Company up to \$24,000 to be used for a portion of the working capital. This loan is non-interest bearing, unsecured and is due at the earlier of (1) the date on which the Company consummates its initial business combination or (2) the date on which the Company liquidates.

## Founder Shares

On April 7, 2021, Sponsor A and Sponsor B acquired 1,357,000 shares and 80,500 shares of Class B common stock, respectively. On May 28, 2021, Sponsor A and Sponsor B surrendered 271,400 and 16,100 shares of Class B common stock, respectively, without consideration. On December 22, 2021, the Company effected a 1.5 for 1 stock split of Class B common stock resulting the Sponsors holding 1,725,000 shares of Class B common stock. On December 28, 2021, the Sponsors converted their shares of Class B common stock into 1,725,000 shares of Class A common stock on a one-for-one basis (up to 225,000 shares of which are subject to forfeiture to the extent that the underwriters' over-allotment option is not exercised in full or in part). As a result, Sponsor A owns 1,628,400 shares of Class A common stock for an aggregate consideration of \$23,600 and Sponsor B owns 96,600 shares of Class A common stock for an aggregate consideration of \$1,400 (collectively "Founder Shares") for an aggregate consideration of \$25,000, or approximately \$0.01 per share. As a result of the underwriters' partial exercise of their over-allotment option on May 17, 2022, 112,500 Founder Shares were subject to forfeiture. On June 3, 2022, the Sponsors executed cancellation notices to the transfer agent to forfeit the remaining 112,500 shares for no consideration.

The Initial Stockholders have agreed, subject to certain limited exceptions, not to transfer, assign or sell any of their Founder Shares until, with respect to 50% of the Founder Shares, the earlier of six months after the consummation of an initial business combination and the date on which the closing price of the Class A common stock equals or exceeds \$12.50 per share (as adjusted for stock splits, stock dividends, reorganizations, recapitalizations and the like) for any 20 trading days within a 30-trading day period commencing after an initial business combination and, with respect to the remaining 50% of the Founder Shares, until the six months after the consummation of an initial business combination, or earlier, in either case, if, subsequent to an initial business combination, the Company completes a liquidation, merger, stock exchange or other similar transaction which results in all of the Company's stockholders having the right to exchange their shares of common stock for cash, securities or other property.

## Administrative Services Agreement

The Company has agreed, commencing on May 12, 2022, to pay Sponsor A up to \$10,000 per month for office space, administrative and shared personnel support services. However, pursuant to the terms of such agreement, the Company may delay payment of such monthly fee upon a determination by the audit committee that there are insufficient funds held outside the trust to pay actual or anticipated expenses in connection with the initial business combination. Any such unpaid amount will accrue without interest and be due and payable no later than the date of the consummation of the initial business combination. This arrangement will terminate upon the earlier of (a) completion of an initial business combination or (b) twelve months after the completion of the IPO. The Company incurred \$106,129 and \$76,129, respectively, in fees for office space, administrative and shared personnel support services, of which \$106,129 and \$76,129 were included in accrued expenses in the accompanying balance sheets at March 31, 2023 and December 31, 2022, respectively.

## Note 6 — Commitments and Contingencies

### Registration Rights

The holders of the Founder Shares, Private Shares and working capital shares issuable upon conversion of working capital loans, if any, will be entitled to registration rights pursuant to a registration rights agreement to be signed prior to or on the effective date of this offering, requiring us to register such securities for resale. The holders of the majority of these securities are entitled to make up to three demands, excluding short form demands, that the Company registers such securities. In addition, the holders have certain "piggy-back" registration rights with respect to registration statements filed subsequent to the completion of the initial business combination and rights to require the Company to register for resale such securities pursuant to Rule 415 under the Securities Act. The Company will bear the expenses incurred in connection with the filing of any such registration statements.

### Underwriting Agreement

The Company has granted Prime Number Capital, LLC and WestPark Capital, Inc. (collectively referred to as the "Underwriters"), a 45-day option from the date of the prospectus to purchase up to 900,000 Public Units (one share of Class A common stock, one-half (1/2) of one redeemable Warrant, and one Right) ("Over-allotment Units") to cover over-allotments, if any, at the IPO price less the underwriting discounts and commissions. On May 17, 2022, simultaneously with the closing of the IPO, the Underwriters partially exercised its over-allotment option to purchase 450,000 Over-allotment Units, generating gross proceeds to the Company of \$4,500,000.

The Underwriters were paid a cash underwriting discount of 2.0% of the gross proceeds of the IPO, or \$1,290,000. In addition, the underwriters will be entitled to a deferred fee of 3.5% of the gross proceeds of the IPO, or \$2,257,500 (the "Deferred Underwriting Commissions"), which will be paid upon the closing of an initial business combination from the amounts held in the Trust Account, subject to the terms of the underwriting agreement.

## Note 7 — Stockholders' Equity

**Preferred Stock** -- The Company is authorized to issue 400,000 shares (reduced from 1,000,000 shares subsequent to IPO on May 10, 2022) of preferred stock with a par value of \$0.0001 per share and with such designations, voting and other rights and preferences as may be determined from time to time by the Company's board of directors. As of March 31, 2023, there was no preferred stock issued or outstanding.

**Class A Common Stock** — The Company is authorized to issue 20,000,000 shares (reduced from 50,000,000 shares subsequent to IPO on May 10, 2022) of Class A common stock with a par value of \$0.0001 per share. On December 28, 2021, the Sponsors converted their shares of Class B common stock into 1,725,000 shares of Class A common stock on a one-for-one basis. As a result of the Underwriters’ partial exercise of their over-allotment option on May 17, 2022, 112,500 Founder Shares were forfeited on May 23, 2022. As of March 31, 2023, there were 2,011,392 shares of common stock issued and outstanding (excluding 6,450,000 shares subject to possible redemption), so that the Initial Stockholders own approximately 20% of the issued and outstanding shares after the IPO.

**Class B Common Stock** — The Company is authorized to issue 100,000 shares (reduced from 2,000,000 shares subsequent to IPO on May 10, 2022) of Class B common stock with a par value of \$0.0001 per share. On December 22, 2021, the Company effected a 1.5 for 1 stock split of our Class B common stock so that the Sponsors owned an aggregate of 1,725,000 shares of Class B common stock. On December 28, 2021, the Sponsors converted their shares of Class B common stock into 1,725,000 shares of Class A common stock on a one-for-one basis (up to 225,000 shares of which are subject to forfeiture depending on the extent to which the underwriter’s over-allotment option is exercised). As of March 31, 2023, there was no Class B common stock issued or outstanding.

**Rights** — Each holder of a right (the “Rights”) will receive one-eighth (1/8) of one share of Class A common stock upon consummation of an initial business combination, even if the holder of such Right redeemed all shares held by it in connection with an initial business combination. No fractional shares will be issued upon conversion of the rights. No additional consideration will be required to be paid by a holder of rights in order to receive its additional shares upon consummation of an initial business combination, as the consideration related thereto has been included in the unit purchase price paid for by investors in the IPO. If the Company enters into a definitive agreement for an initial business combination in which the Company will not be the surviving entity, the definitive agreement will provide for the holders of rights to receive the same per share consideration the holders of the common stock will receive in the transaction on an as-converted into common stock basis and each holder of a Right will be required to affirmatively convert its Rights in order to receive 1/8 share underlying each Right (without paying additional consideration). The shares issuable upon conversion of the Rights will be freely tradable (except to the extent held by affiliates of the Company).

If the Company is unable to complete an initial business combination within the Combination Period and the Company liquidates the funds held in the Trust Account, holders of Rights will not receive any of such funds with respect to their Rights, nor will they receive any distribution from the Company’s assets held outside of the Trust Account with respect to such Rights, and the Rights will expire worthless. Further, there are no contractual penalties for failure to deliver securities to the holders of the Rights upon consummation of an initial business combination. Additionally, in no event will the Company be required to net cash settle the Rights. Accordingly, the Rights may expire worthless.

**Warrants** — Each redeemable warrant (the “Warrant”) entitles the holder thereof to purchase one share of common stock at a price of \$11.50 per share, subject to adjustment as described in this prospectus. The Warrants will become exercisable on the later of the completion of an initial business combination and 12 months from the closing of the IPO. However, no Public Warrants will be exercisable for cash unless the Company has an effective and current registration statement covering the issuance of the common stock issuable upon exercise of the Warrants and a current prospectus relating to such common stock. Notwithstanding the foregoing, if a registration statement covering the issuance of the common stock issuable upon exercise of the Public Warrants is not effective within 90 days from the closing of the Company’s initial business combination, warrant holders may, until such time as there is an effective registration statement and during any period when we shall have failed to maintain an effective registration statement, exercise Warrants on a cashless basis pursuant to an available exemption from registration under the Securities Act. If an exemption from registration is not available, holders will not be able to exercise their Warrants on a cashless basis. The Warrants will expire five years from the closing of the Company’s initial business combination at 5:00 p.m., New York City time or earlier redemption.

In addition, if (x) the Company issues additional shares of Class A common stock or equity-linked securities for capital raising purposes in connection with the closing of the Company’s initial business combination at an issue price or effective issue price of less than \$9.20 per share (with such issue price or effective issue price to be determined in good faith by the board of directors and, in the case of any such issuance to our founders or their affiliates, without taking into account any founder shares held by founders or such affiliates, as applicable, prior to such issuance) (the “Newly Issued Price”), (y) the aggregate gross proceeds from such issuances represent more than 60% of the total equity proceeds, and interest thereon, available for the funding of the Company’s initial business combination (net of redemption), and (z) the volume weighted average trading price of the Company’s Class A common stock during the 20 trading day period starting on the trading day prior to the day on which the Company consummates its initial business combination (such price, the “Market Price”) is below \$9.20 per share, the exercise price of the Warrants will be adjusted (to the nearest cent) to be equal to 115% of the Market Price, and the \$16.50 per share redemption trigger price described below will be adjusted (to the nearest cent) to be equal to 180% of the greater of the Market Value and the Newly Issued Price.

The Company may redeem the outstanding Public Warrants at any time while the Warrants are exercisable:

- in whole and not in part;
- at a price of \$0.01 per Warrant;
- upon a minimum number of 30 days' prior written notice of redemption, which the Company refers to as the 30-day redemption period;
- if, and only if, the last reported sale price of the Company's common stock equals or exceeds \$16.50 per share (as adjusted for stock splits, stock dividends, reorganizations, recapitalizations and the like) for any 20 trading days within a 30-trading day period ending on the third trading day prior to the date on which the Company sends the notice of redemption to the to the warrant holders.

If the Company calls the Public Warrants for redemption, management will have the option to require all holders that wish to exercise the Public Warrants to do so on a "cashless basis," as described in the warrant agreement. In such event, each holder would pay the exercise price by surrendering the whole warrants for that number of shares of common stock equal to the quotient obtained by dividing (x) the product of the number of shares of common stock underlying the warrants, multiplied by the difference between the exercise price of the warrants and the "fair market value" (defined below) by (y) the fair market value. The "fair market value" shall mean the average reported last sale price of the common stock for the 10 trading days ending on the third trading day prior to the date on which the notice of redemption is sent to the holders of warrants.

Except as described above, no warrants will be exercisable and the Company will not be obligated to issue common stock unless at the time a holder seeks to exercise such warrant, a prospectus relating to the Class A common stock issuable upon exercise of the warrants is current and the common stock have been registered or qualified or deemed to be exempt under the securities laws of the state of residence of the holder of the warrants. Under the terms of the warrant agreement, the Company has agreed to use its best efforts to meet these conditions and to maintain a current prospectus relating to the common stock issuable upon exercise of the warrants until the expiration of the warrants. However, the Company cannot assure that it will be able to do so and, if the Company does not maintain a current prospectus relating to the common stock issuable upon exercise of the warrants, holders will be unable to exercise their warrants and the Company will not be required to settle any such warrant exercise. If the prospectus relating to the Class A common stock issuable upon the exercise of the warrants is not current or if the common stock is not qualified or exempt from qualification in the jurisdictions in which the holders of the warrants reside, the Company will not be required to net cash settle or cash settle the warrant exercise, the warrants may have no value, the market for the warrants may be limited and the warrants may expire worthless.

#### **Note 8 — Fair Value Measurements**

The fair value of the Company's consolidated financial assets and liabilities reflects management's estimate of amounts that the Company would have received in connection with the sale of the assets or paid in connection with the transfer of the liabilities in an orderly transaction between market participants at the measurement date. In connection with measuring the fair value of its assets and liabilities, the Company seeks to maximize the use of observable inputs (market data obtained from independent sources) and to minimize the use of unobservable inputs (internal assumptions about how market participants would price assets and liabilities). The following fair value hierarchy is used to classify assets and liabilities based on the observable inputs and unobservable inputs used in order to value the assets and liabilities:

- Level 1: Quoted prices in active markets for identical assets or liabilities. An active market for an asset or liability is a market in which transactions for the asset or liability occur with sufficient frequency and volume to provide pricing information on an ongoing basis.
- Level 2: Observable inputs other than Level 1 inputs. Examples of Level 2 inputs include quoted prices in active markets for similar assets or liabilities and quoted prices for identical assets or liabilities in markets that are not active.
- Level 3: Unobservable inputs based on the assessment of the assumptions that market participants would use in pricing the asset or liability.



The following tables present information about the Company’s assets that are measured at fair value on a recurring basis at March 31, 2023 and December 31, 2022, which indicate the fair value hierarchy of the valuation inputs the Company utilized to determine such fair value.

	<b>March 31, 2023</b>	<b>Quoted Prices in Active Markets (Level 1)</b>	<b>Significant Other Observable Inputs (Level 2)</b>	<b>Significant Other Unobservable Inputs (Level 3)</b>
<b>Assets</b>				
Marketable Securities in the Trust Account	67,431,759	67,431,759	—	—
	<b>December 31, 2022</b>	<b>Quoted Prices in Active Markets (Level 1)</b>	<b>Significant Other Observable Inputs (Level 2)</b>	<b>Significant Other Unobservable Inputs (Level 3)</b>
<b>Assets</b>				
Marketable Securities in the Trust Account	66,718,520	66,718,520	—	—

#### **Note 9 — Subsequent Events**

In accordance with ASC 855, “Subsequent Events,” the Company evaluated subsequent events and transactions that occurred after the balance sheet date up to the date that the financial statements were issued. Based on the review as further disclosed in the footnotes, management identified the following subsequent event requiring disclosure in the financial statements.

On April 23, 2023, DBG Global Limited, a member of Sponsor A, loaned the Company up to \$24,000 to be used for a portion of the working capital. This loan is non-interest bearing, unsecured and is due at the earlier of (1) the date on which the Company consummates its initial business combination or (2) the date on which the Company liquidates.

On May 15, 2023, the Company held a special meeting of stockholders (the “Special Meeting”). At the Special Meeting, the stockholders of the Company approved the proposal to amend the Company’s then effective Amended and Restated Certificate of Incorporation to (i) allow the Company until May 17, 2023 to consummate an initial business combination, and to (ii) elect to extend the period to consummate an initial business combination up to six times, each by an additional one-month period, for a total of up to six months to November 17, 2023 (“Extended Termination Date”), by depositing to the Company’s Trust Account the amount lesser of (i) \$125,000 for each one-month extension or (ii) \$0.045 for each Public Share for each one-month extension.

In connection with the votes to approve the Extension Amendment Proposal, 1,537,701 Public Shares of the Company were tendered for redemption. As of the date of this proxy statement/prospectus, all such Public Shares are in the process of redemption by our transfer agent, VStock Transfer, LLC, which shall result in a total of 4,912,299 Public Shares remaining after the consummation of such process.

On May 15, the Company released a press release announcing its intent to extend the deadline that it must complete its initial business combination from May 17, 2023 to June 17, 2023 and its intent to cause the Sponsor or its designee to deposit an aggregate of \$125,000 into the Trust Account.

On May 17, 2023, \$125,000 was deposited into the Trust Account for the public stockholders to effectuate the First Monthly Extension. Accordingly, the Company issued an unsecured promissory note of \$208,594.15 (the “noco-noco Note”) noco-noco to evidence the payments made by noco-noco for the First Monthly Extension payment and 50% of the registration fee for filing of a registration statement/proxy statement in Form F-4 with the U.S. securities and exchange commission. The noco-noco Note bears no interest and is payable in full upon the earlier to occur of (i) the consummation of an initial business combination or (ii) the date of expiry of the term of the Company, in cash or shares of the Company at \$10.00 per share, at the discretion of the note holder.

#### **Note 10 — Events (Unaudited) Subsequent to the Date of the Form 10-Q filed on May 22, 2023**

On June 14, 2023, an aggregate of \$125,000 (the “Monthly Extension Payment”) was deposited by noco-noco upon request by the sponsors of the Company, into the Trust Account of the Company, as a result of which, the Company has extended the period of time it has to consummate its initial business combination by one month from June 17, 2023 to July 17, 2023 (the “June Extension”). The June Extension is the second of the six one-month extensions permitted under the Existing PNAC Charter.

In connection with the Monthly Extension Payment, the Company issued an unsecured promissory note of \$125,000 (the “June Extension Note”) to noco-noco. The June Extension Note is non-interest bearing and payable (subject to the waiver against trust provisions) on the earlier of (i) consummation of the Company’s initial business combination and (ii) the date of the liquidation of the Company. The principal balance may be prepaid at any time, at the election of the Company. The holder of the June Extension Note has the right, but not the obligation, to convert the Note, in whole or in part, respectively, into private placement shares (the “Working Capital Shares”) of the Company, by providing the Company with written notice of its intention to convert the Note at least two business days prior to the closing of the Company’s initial business combination. The number of Working Capital Shares to be received by the holder in connection with such conversion shall be an amount determined by dividing (x) the sum of the outstanding principal amount payable to the holder, by (y) \$10.00.

## REPORT OF INDEPENDENT REGISTERED PUBLIC ACCOUNTING FIRM

To the Board of Directors and Stockholders of Prime Number Acquisition I Corp.

### Opinion on the Financial Statements

We have audited the accompanying balance sheets of Prime Number Acquisition I Corp. (the Company) as of December 31, 2022 and 2021, and the related statements of operations, changes in stockholders' equity, and cash flows for the year ended December 31, 2022 and for the period from February 25, 2021 (inception) to December 31, 2021, and the related notes (collectively referred to as the "financial statements"). In our opinion, the financial statements present fairly, in all material respects, the financial position of the Company as of December 31, 2022 and 2021, and the results of its operations and its cash flows for the year ended December 31, 2022, and for the period from February 25, 2021 (inception) to December 31, 2021, in conformity with accounting principles generally accepted in the United States of America.

### Substantial Doubt about the Company's Ability to Continue as a Going Concern

The accompanying financial statements have been prepared assuming the Company will continue as a going concern. As discussed in Note 1 to the financial statements, the Company has no revenue, its business plan is dependent on the completion of a financing transaction and the Company's cash and working capital are not sufficient to complete its planned activities one year from the issuance of the financial statements. These conditions raise substantial doubt about the Company's ability to continue as a going concern. Management's evaluation of the events and conditions and management's plans regarding these matters are also described in Note 1 to the financial statements. The financial statements do not include any adjustments that might result from the outcome of this uncertainty. Our opinion is not modified with respect to that matter.

### Basis for Opinion

These financial statements are the responsibility of the Company's management. Our responsibility is to express an opinion on the Company's financial statements based on our audits. We are a public accounting firm registered with the Public Company Accounting Oversight Board (United States) (PCAOB) and are required to be independent with respect to the Company in accordance with the U.S. federal securities laws and the applicable rules and regulations of the Securities and Exchange Commission and the PCAOB.

We conducted our audits in accordance with the standards of the PCAOB. Those standards require that we plan and perform the audits to obtain reasonable assurance about whether the financial statements are free of material misstatement, whether due to error or fraud. The Company is not required to have, nor were we engaged to perform, an audit of its internal control over financial reporting. As part of our audits, we are required to obtain an understanding of internal control over financial reporting, but not for the purpose of expressing an opinion on the effectiveness of the Company's internal control over financial reporting. Accordingly, we express no such opinion.

Our audits included performing procedures to assess the risks of material misstatement of the financial statements, whether due to error or fraud, and performing procedures that respond to those risks. Such procedures included examining, on a test basis, evidence regarding the amounts and disclosures in the financial statements. Our audits also included evaluating the accounting principles used and significant estimates made by management, as well as evaluating the overall presentation of the financial statements. We believe that our audits provide a reasonable basis for our opinion.

/s/ UHY LLP

We have served as the Company's auditor since 2021.  
New York, New York  
April 3, 2023

**PRIME NUMBER ACQUISITION I CORP.**  
**BALANCE SHEETS**

	December 31, 2022	December 31, 2021
<b>Assets</b>		
<b>Current Assets</b>		
Cash	\$ 278,295	\$ 125,303
Prepaid expenses	125,384	—
Other receivable	—	700
Deferred offering costs	—	247,640
Investments held in Trust Account	66,718,520	—
Total current assets	67,122,199	373,643
<b>Total Assets</b>	<b>\$ 67,122,199</b>	<b>\$ 373,643</b>
<b>Liabilities, Redeemable Common Stock and Stockholder's Equity (Deficit)</b>		
<b>Current Liabilities</b>		
Accounts payable and accrued expenses	\$ 90,004	\$ —
Franchise tax payable	43,853	—
Income tax payable	112,446	—
Promissory note – related party	—	350,000
Deferred income tax liability	37,190	—
Deferred underwriting fee payable	2,257,500	—
Total current liabilities	2,540,993	350,000
<b>Total Liabilities</b>	<b>2,540,993</b>	<b>350,000</b>
<b>Commitments and Contingencies</b>		
Common stock subject to possible redemption, 6,450,000 shares at redemption value of \$10.34 per share	66,718,520	—
<b>Stockholders' Equity (Deficit)</b>		
Preferred stock, \$0.0001 par value; 400,000 shares and 1,000,000 shares authorized, none issued or outstanding at December 31, 2022 and December 31, 2021, respectively	—	—
Class A common stock, \$0.0001 par value; 20,000,000 shares and 50,000,000 shares authorized; 2,011,392 and 1,725,000 issued and outstanding at December 31, 2022 (excluding 6,450,000 shares subject to possible redemption) and December 31, 2021, respectively	201	173
Class B common stock, \$0.0001 par value; 100,000 shares and 2,000,000 shares authorized; none issued or outstanding at December 31, 2022 and December 31, 2021, respectively	—	—
Additional paid-in capital	—	24,827
Accumulated deficit	(2,137,515)	(1,357)
<b>Total Stockholders' Equity (Deficit)</b>	<b>(2,137,314)</b>	<b>23,643</b>
<b>Total Liabilities, Redeemable Common Stock and Stockholders' Equity (Deficit)</b>	<b>\$ 67,122,199</b>	<b>\$ 373,643</b>

The accompanying notes are an integral part of these financial statements.

**PRIME NUMBER ACQUISITION I CORP.**  
**STATEMENTS OF OPERATIONS**

	<b>For the year ended December 31, 2022</b>	<b>For the period from February 25, 2021 (inception) through December 31, 2021</b>
General and administrative expenses	\$ 588,973	\$ 1,357
Franchise tax expenses	47,980	—
<b>Loss from operations</b>	<b>(636,953)</b>	<b>(1,357)</b>
Interest earned on investment held in Trust Account	712,555	—
Unrealized gain on investments held in Trust Account	215,965	—
Income (loss) before income taxes	291,567	(1,357)
Income taxes provision	(112,446)	—
Deferred income taxes provision	(37,190)	—
<b>Net income (loss)</b>	<b>\$ 141,931</b>	<b>\$ (1,357)</b>
Basic and diluted weighted average shares outstanding of redeemable common stock	4,040,110	—
Basic and diluted net income per share of redeemable common stock	0.93	—
Basic and diluted weighted average shares outstanding of non-redeemable common stock	1,906,243	1,044,862
Basic and diluted net loss per share of non-redeemable common stock	\$ (1.90)	\$ (0.00)

The accompanying notes are an integral part of these financial statements.

**PRIME NUMBER ACQUISITION I CORP.**  
**STATEMENTS OF CHANGES IN STOCKHOLDER'S EQUITY(DEFICIT)**

	<u>Class A Common Stock</u>		<u>Additional Paid-in Capital</u>	<u>Accumulated Deficit</u>	<u>Total Shareholders' Deficit</u>
	<u>Shares</u>	<u>Amount</u>			
<b>Balance as of January 1, 2022</b>	1,725,000	\$ 173	\$ 24,827	\$ (1,357)	\$ 23,643
Sale of public units in initial public offering	6,450,000	645	64,499,355	—	64,500,000
Sale of private placement units	398,892	40	3,988,880	—	3,988,920
Forfeiture of Founder Shares	(112,500)	(11)	(11)	—	(22)
Underwriter commissions	—	—	(3,547,500)	—	(3,547,500)
Offering costs	—	—	(571,515)	—	(571,515)
Reimbursement of offering expense from underwriter	—	—	45,750	—	45,750
Reclassification of common stock subject to redemption	(6,450,000)	(645)	(59,016,855)	—	(59,017,500)
Allocation of offering costs to common stock subject to redemption	—	—	3,767,869	—	3,767,869
Accretion of common stock to redemption value	—	—	(9,190,800)	(1,349,569)	(10,540,369)
Subsequent measurement of common stock subject to redemption under ASC 480-10-S99 against accumulated deficit	—	—	—	(928,520)	(928,520)
Net income for the year	—	—	—	141,931	141,931
<b>Balance as of December 31, 2022</b>	<u>2,011,392</u>	<u>\$ 201</u>	<u>\$ —</u>	<u>\$ (2,137,515)</u>	<u>\$ (2,137,314)</u>

	Common Stock				Additional Paid-in Capital	Accumulated Deficit	Total Shareholder's Equity
	Class A		Class B				
	Shares	Amount	Shares	Amount			
<b>Balance as of February 25, 2021 (inception)</b>	—	\$ —	—	\$ —	\$ —	\$ —	\$ —
Class B common stock issued to initial stockholders	—	—	1,437,500	144	24,856	—	25,000
Surrender of Class B common stock	—	—	(287,500)	(29)	29	—	—
1.5 for 1 stock split of Class B common stock	—	—	575,000	58	(58)	—	—
Conversion of Class B to Class A common stock (1)	1,725,000	173	(1,725,000)	(173)	—	—	—
Net loss	—	—	—	—	—	(1,357)	(1,357)
<b>Balance as of December 31, 2021</b>	<b>1,725,000</b>	<b>\$ 173</b>	<b>—</b>	<b>\$ —</b>	<b>\$ 24,827</b>	<b>\$ (1,357)</b>	<b>\$ 23,643</b>

(1) Includes up to 225,000 shares of Class A common stock subject to forfeiture if the over-allotment option is not exercised in full or in part by the underwriters.

The accompanying notes are an integral part of these financial statements.

**PRIME NUMBER ACQUISITION I CORP.**  
**STATEMENTS OF CASH FLOWS**

	<b>For the Year Ended December 31, 2022</b>	<b>For the Period from February 25, 2021 (inception) through December 31, 2021</b>
<b>Cash flows from operating activities:</b>		
Net income (loss)	\$ 141,931	\$ (1,357)
Adjustments to reconcile net cash used in operating activities:		
Interest earned on investment held in Trust Account	(712,555)	—
Unrealized gain on investments held in Trust Account	(215,965)	—
Prepaid expenses	(125,384)	(700)
Accounts payable and accrued expenses	90,004	—
Franchise tax payable	43,853	—
Income tax payable	112,446	—
Deferred income tax liability	37,190	—
<b>Net cash used in operating activities</b>	<b>(628,480)</b>	<b>(2,057)</b>
<b>Cash Flows from Investing Activities:</b>		
Purchase of investment held in Trust Account	(65,790,000)	—
<b>Net cash used in financing activities</b>	<b>(65,790,000)</b>	<b>—</b>
<b>Cash Flows from Financing Activities:</b>		
Proceeds from issuance of insider shares to the initial stockholders	—	25,000
Proceeds from sale of public units through public offering	64,500,000	—
Proceeds from sale of private placement units	3,988,920	—
Proceeds from promissory note- related party	—	350,000
Reimbursement of expenses from underwriter	45,750	—
Repayment of promissory note to related party	(350,000)	—
Payment of underwriters' commissions	(1,290,000)	—
Payment of deferred offering costs	(323,198)	(247,640)
<b>Net cash provided by financing activities</b>	<b>66,571,472</b>	<b>127,360</b>
<b>Net change in cash</b>	<b>152,992</b>	<b>125,303</b>
<b>Cash, beginning of the period</b>	<b>125,303</b>	<b>—</b>
<b>Cash, end of the period</b>	<b>\$ 278,295</b>	<b>\$ 125,303</b>
<b>Supplemental Disclosure of Non-cash Financing Activities</b>		
Initial classification of common stock subject to redemption	\$ 59,017,500	\$ —
Allocation of offering costs to common stock subject to redemption	\$ 3,767,869	\$ —
Accretion of common stock to redemption value	\$ 10,540,369	\$ —
Subsequent measurement of common stock to redemption value	\$ 928,520	\$ —

The accompanying notes are an integral part of these financial statements.

## PRIME NUMBER ACQUISITION I CORP.

### NOTES TO FINANCIAL STATEMENTS

#### Note 1 — Description of Organization and Business Operations

Prime Number Acquisition I Corp. (the “Company”) is a newly organized blank check company incorporated as a Delaware corporation on February 25, 2021. The Company was formed for the purpose of effecting a merger, share exchange, asset acquisition, share purchase, reorganization or similar business combination with one or more businesses or entities (the “Business Combination”). The Company is an early stage and emerging growth company and, as such, it is subject to all of the risks associated with early stage and emerging growth companies.

As of December 31, 2022, the Company had not commenced any operations. Activities before May 17, 2022 are related to the formation and IPO, while the activities after May 17, 2022 are mainly focused on searching and identifying the Business Combination target. The Company will not generate any operating revenues until after the completion of a Business Combination, at the earliest. The Company will generate non-operating income in the form of interest income from the proceeds derived from the IPO. The Company has selected December 31 as its fiscal year end.

The Company’s sponsors are Prime Number Acquisition LLC (“Sponsor A”) and Glorious Capital LLC (“Sponsor B”) (collectively the “Sponsors”), both are Delaware limited liability companies.

The registration statement for the Company’s IPO became effective on May 12, 2022. On May 17, 2022, the Company consummated the initial public offering (the “IPO”) of 6,450,000 units (the “Public Units”) which included 450,000 units issued upon the partial exercise of the underwriters’ over-allotment option. The Public Units were sold at an offering price of \$10.00 per unit, with each Public Unit consists of one share (the “Public Shares”) of the Company’s Class A common stock (the “Class A common stock”), one half of one warrant, and one right, generating gross proceeds of \$64,500,000. Simultaneously with the IPO, the Company completed the private sale of 398,892 shares of the Class A common stock (the “Private Shares”) to the Company’s Sponsors, including 349,032 shares to Sponsor A and 49,860 shares to Sponsor B, at a purchase price of \$10.00 per Private Share, generating gross proceeds of \$3,988,920 (including \$3,490,320 from Sponsor A and \$498,600 from Sponsor B), which is described in Note 4.

Upon the closing of the IPO and the private placement on May 17, 2022, the proceeds of \$65,790,000 (or \$10.20 per Public Unit) in the aggregate from the IPO and the private placement were placed in a trust account (the “Trust Account” as defined in Note 5) with Wilmington Trust, N.A. acting as trustee and will be invested only in U.S. government treasury bills with a maturity of 185 days or less or in money market funds meeting certain conditions under Rule 2a-7 under the Investment Company Act of 1940, as amended (the “Investment Company Act”), and that invest only in direct U.S. government treasury obligations. These funds will not be released until the earlier of the completion of the initial Business Combination or the liquidation due to the Company’s failure to complete a Business Combination within the applicable period of time. The proceeds deposited in the Trust Account could become subject to the claims of the Company’s creditors, if any, which could have priority over the claims of the Company’s holders of its outstanding Public Shares (the “Public Stockholders”). In addition, interest income earned on the funds in the Trust Account may be released to the Company to pay its income or other tax obligations. With these exceptions, expenses incurred by the Company may be paid prior to a Business Combination only from the net proceeds of the IPO and private placement not held in the Trust Account.

Pursuant to Nasdaq listing rules, the Company’s initial Business Combination must occur with one or more target businesses having an aggregate fair market value equal to at least 80% of the value of the funds in the Trust Account (excluding any deferred underwriting discounts and commissions and taxes payable on the income earned on the Trust Account), which the Company refers to as the 80% test, at the time of the execution of a definitive agreement for its initial Business Combination, although the Company may structure a Business Combination with one or more target businesses whose fair market value significantly exceeds 80% of the Trust Account balance. If the Company is no longer listed on Nasdaq, it will not be required to satisfy the 80% test. The Company will only complete a Business Combination if the post-transaction company owns or acquires 50% or more of the outstanding voting securities of the target or otherwise acquires a controlling interest in the target sufficient for it not to be required to register as an investment company under the Investment Company Act.



The Company will provide its holders of the outstanding Public Shares with the opportunity to redeem all or a portion of their Public Shares upon the completion of a Business Combination either (i) in connection with a stockholder meeting called to approve the Business Combination or (ii) by means of a tender offer. The decision as to whether the Company will seek stockholder approval of a Business Combination or conduct a tender offer will be made by the Company. The Public Stockholders will be entitled to redeem their Public Shares for a pro rata portion of the amount then in the Trust Account (initially anticipated to be \$10.20 per Public Share, plus any pro rata interest earned on the funds held in the Trust Account and not previously released to the Company) to pay its franchise and income tax obligations.

If a stockholder vote is not required by law and the Company does not decide to hold a stockholder vote for business or other legal reasons, the Company will, pursuant to its Amended and Restated Certificate of Incorporation (the “Amended and Restated Certificate of Incorporation”), conduct the redemptions pursuant to the tender offer rules of the U.S. Securities and Exchange Commission (“SEC”) and file tender offer documents with the SEC prior to completing a Business Combination. If, however, stockholder approval of the transaction is required by law, or the Company decides to obtain stockholder approval for business or legal reasons, the Company will offer to redeem shares in conjunction with a proxy solicitation pursuant to the proxy rules and not pursuant to the tender offer rules. Additionally, each public stockholder may elect to redeem their Public Shares irrespective of whether they vote for or against the proposed transaction. If the Company seeks stockholder approval in connection with a Business Combination, the Company’s Sponsors and any of the Company’s officers or directors that may hold Founder Shares (as defined in Note 5) (the “Initial Stockholders”) have agreed (a) to vote their Founder Shares, the Private Shares, and any Public Shares purchased during or after the IPO in favor of approving a Business Combination and (b) not to convert any shares (including the Insider Shares) in connection with a stockholder vote to approve, or sell the shares to the Company in any tender offer in connection with, a proposed Business Combination.

The Company’s Initial Stockholders have agreed (A) to vote their Founder Shares, Private Shares and any Public Shares they own in favor of any proposed Business Combination, (B) not to propose, or vote in favor of, prior to and unrelated to an initial Business Combination, an amendment to the Company’s certificate of incorporation that would affect the substance or timing of the Company’s redemption obligation to redeem all public shares if the Company cannot complete an initial Business Combination within the Combination Period (as defined below), unless the Company provides Public Stockholders an opportunity to redeem their public shares in conjunction with any such amendment, (C) not to redeem any shares, including Founder Shares, Private Shares and any Public Shares they own into the right to receive cash from the Trust Account in connection with a stockholder vote to approve the Company’s proposed initial Business Combination or sell any shares to the Company in any tender offer in connection with its proposed initial Business Combination, and (D) that the Founder Shares and Private Shares shall not participate in any liquidating distribution upon winding up if a Business Combination is not consummated.

If the Company seeks stockholder approval of a Business Combination and it does not conduct redemptions pursuant to the tender offer rules, the Amended and Restated Certificate of Incorporation provides that a public stockholder, together with any affiliate of such stockholder or any other person with whom such stockholder is acting in concert or as a “group” (as defined under Section 13 of the Securities Exchange Act of 1934, as amended (the “Exchange Act”)), will be restricted from redeeming its shares with respect to more than an aggregate of 15% of the shares sold the IPO.

The Initial Stockholders and underwriters have agreed (a) to waive their redemption rights with respect to the Insider Shares, Private Shares, and Public Shares held by them in connection with the completion of a Business Combination and (b) not to propose, or vote in favor of, an amendment to the Amended and Restated Certificate of Incorporation that would affect the substance or timing of the Company’s obligation to redeem 100% of its Public Shares if the Company does not complete a Business Combination, unless the Company provides the public stockholders with the opportunity to redeem their Public Shares in conjunction with any such amendment.

The Company will have until May 17, 2023 (or November 17, 2023 if the Company extends the period of time to consummate a Business Combination) to consummate a Business Combination (the “Combination Period”). If the Company is unable to complete a Business Combination within the Combination Period, the Company will (i) cease all operations except for the purpose of winding up, (ii) as promptly as reasonably possible but not more than ten business days thereafter, redeem the Public Shares, at a per-share price, payable in cash, equal to the aggregate amount then on deposit in the Trust Account including interest (which interest shall be net of taxes payable, and less interest to pay dissolution expenses) divided by the number of then outstanding Public Shares, which redemption will completely extinguish public stockholders’ rights as stockholders (including the right to receive further liquidating distributions, if any), subject to applicable law, and (iii) as promptly as reasonably possible following such redemption, subject to the approval of the Company’s remaining stockholders and the Company’s board of directors, dissolve and liquidate, subject in each case to the Company’s obligations under Delaware law to provide for claims of creditors and the requirements of other applicable law.

The Initial Stockholders have agreed to waive their liquidation rights with respect to the Founder Shares and Private Shares if the Company fails to complete a Business Combination within the Combination Period. However, if the Initial Stockholders acquire Public Shares in or after the IPO, such Public Shares will be entitled to liquidating distributions from the Trust Account if the Company fails to complete a Business Combination within the Combination Period. The Underwriters (as defined in Note 5) have agreed to waive their rights to their Deferred Underwriting Commissions (see Note 6) held in the Trust Account in the event the Company does not complete a Business Combination within the Combination Period and, in such event, such amounts will be included with the other funds held in the Trust Account that will be available to fund the redemption of the Public Shares. In the event of such distribution, it is possible that the per share value of the assets remaining available for distribution will be less than \$10.20.

In order to protect the amounts held in the Trust Account, the Sponsors have agreed to be liable to the Company if and to the extent any claims by a third party for services rendered or products sold to the Company, or a prospective target business with which the Company has discussed entering into a transaction agreement, reduce the amount of funds in the Trust Account to below (i) \$10.20 per Public Share or (ii) such lesser amount per Public Share held in the Trust Account as of the date of the liquidation of the Trust Account, due to reductions in value of the trust assets, in each case net of the amount of interest which may be withdrawn to pay taxes, except as to any claims by a third party who executed a waiver of any and all rights to seek access to the Trust Account and except as to any claims under our indemnity of the Underwriters of this IPO against certain liabilities, including liabilities under the Securities Act. In the event that an executed waiver is deemed to be unenforceable against a third party, then the Sponsors will not be responsible to the extent of any liability for such third party claims.

On December 29, 2022, the Company, Prime Number Merger Sub Inc. (“Merger Sub”), a Delaware corporation, NOCO-NOCO PTE. LTD (“noco-noco”), a Singapore private company limited by shares, and certain shareholders of noco-noco (“Sellers”) entered into the Business Combination Agreement (“the Merger Agreement”), pursuant to which, (i) the Company shall merge with and into Merger Sub, with the Company being the surviving company and a wholly owned subsidiary of PubCo, a Cayman Islands company to be formed pursuant to the Merger Agreement, and (ii) following the merger, New SubCo, a Singapore private company to be formed pursuant to the Merger Agreement, will acquire all of the issued and outstanding shares of the Sellers, in exchange for PubCo to issue to the Sellers PubCo Ordinary Shares.

### **Going Concern**

As of December 31, 2022, the Company had cash of \$278,295 and a working capital of \$313,675 (excluding investments held in trust account, deferred underwriting fee payable, deferred income tax liability and taxes payable). The Company’s liquidity needs up to the closing of the IPO on May 17, 2022 had been satisfied through proceeds from notes payable and advances from a related party and from the issuance of common stock.

The Company has 12 months from the closing of the IPO to consummate a Business Combination. It is uncertain that the Company will be able to consummate a Business Combination by this time. If a Business Combination is not consummated by this date, there will be a mandatory liquidation and subsequent dissolution.

In order to finance transaction costs in connection with a Business Combination, the Company’s Sponsor or an affiliate of the Sponsor or certain of the Company’s officers and directors may, but are not obligated to, provide the Company with working capital. The Company’s management plans to continue its efforts to complete a Business Combination within the Combination Period.

If the estimated costs of identifying a target business, undertaking in-depth due diligence and negotiating a Business Combination are less than the actual amount necessary to do so, the Company may have insufficient funds available to operate its business prior to its Business Combination. Moreover, the Company may need to obtain additional financing either to complete its Business Combination or because it becomes obligated to redeem a significant number of public shares upon consummation of its Business Combination, in which case the Company may issue additional securities or incur debt in connection with such Business Combination. Subject to compliance with applicable securities laws, the Company would only complete such financing simultaneously with the completion of our Business Combination.

In connection with the Company's assessment of going concern considerations in accordance with FASB ASC Topic 205-40, "Presentation of Financial Statements — Going Concern," management has determined that mandatory liquidation, should a Business Combination not occur, and potential subsequent dissolution raises substantial doubt about the Company's ability to continue as a going concern for a reasonable period of time, which is considered to be one year from the issuance of the financial statements.

### **Risks and Uncertainties**

Management is currently evaluating the impact of the COVID-19 pandemic on the industry and has concluded that while it is reasonably possible that the virus could have a negative effect on the Company's future financial position, results of its operations and/or search for a target company, there has not been a significant impact as of the date of these financial statements. The financial statements do not include any adjustments that might result from the future outcome of this uncertainty.

Additionally, as a result of the military action commenced in February 2022 by the Russian Federation and Belarus in the country of Ukraine and related economic sanctions, the Company's ability to consummate a Business Combination, or the operations of a target business with which the Company ultimately consummates a Business Combination, may be materially and adversely affected. In addition, the Company's ability to consummate a transaction may be dependent on the ability to raise equity and debt financing which may be impacted by these events, including as a result of increased market volatility, or decreased market liquidity in third-party financing being unavailable on terms acceptable to the Company or at all. The impact of this action and related sanctions on the world economy and the specific impact on the Company's financial position, results of operations and/or ability to consummate a Business Combination are not yet determinable. The financial statements do not include any adjustments that might result from the outcome of this uncertainty.

On August 16, 2022, the Inflation Reduction Act of 2022 (the "IR Act") was signed into federal law. The IR Act provides for, among other things, a new U.S. federal 1% excise tax on certain repurchases (including redemptions) of stock by publicly traded domestic (i.e., U.S.) corporations and certain domestic subsidiaries of publicly traded foreign corporations. The excise tax is imposed on the repurchasing corporation itself, not its shareholders from which shares are repurchased. The amount of the excise tax is generally 1% of the fair market value of the shares repurchased at the time of the repurchase. However, for purposes of calculating the excise tax, repurchasing corporations are permitted to net the fair market value of certain new stock issuances against the fair market value of stock repurchases during the same taxable year. In addition, certain exceptions apply to the excise tax. The U.S. Department of the Treasury (the "Treasury") has been given authority to provide regulations and other guidance to carry out and prevent the abuse or avoidance of the excise tax. The IR Act applies only to repurchases that occur after December 31, 2022.

Any redemption or other repurchase that occurs after December 31, 2022, in connection with a Business Combination, extension vote or otherwise, may be subject to the excise tax. Whether and to what extent the Company would be subject to the excise tax in connection with a Business Combination, extension vote or otherwise would depend on a number of factors, including (i) the fair market value of the redemptions and repurchases in connection with the Business Combination, extension or otherwise, (ii) the structure of a Business Combination, (iii) the nature and amount of any "PIPE" or other equity issuances in connection with a Business Combination (or otherwise issued not in connection with a Business Combination but issued within the same taxable year of a Business Combination) and (iv) the content of regulations and other guidance from the Treasury. In addition, because the excise tax would be payable by the Company and not by the redeeming holder, the mechanics of any required payment of the excise tax have not been determined. The foregoing could cause a reduction in the cash available on hand to complete a Business Combination and in the Company's ability to complete a Business Combination.

### **Note 2 — Significant Accounting Policies**

#### **Basis of Presentation**

The accompanying financial statements are presented in conformity with accounting principles generally accepted in the United States of America ("GAAP") and pursuant to the rules and regulations of the SEC. Accordingly, they include all of the information and footnotes required by GAAP. In the opinion of management, all adjustments (consisting of normal accruals) considered for a fair presentation have been included.

## **Emerging Growth Company**

The Company is an “emerging growth company,” as defined in Section 2(a) of the Securities Act, as modified by the Jumpstart Our Business Startups Act of 2012 (the “JOBS Act”), and it may take advantage of certain exemptions from various reporting requirements that are applicable to other public companies that are not emerging growth companies including, but not limited to, not being required to comply with the independent registered public accounting firm attestation requirements of Section 404 of the Sarbanes-Oxley Act of 2002, reduced disclosure obligations regarding executive compensation in its periodic reports and proxy statements, and exemptions from the requirements of holding a nonbinding advisory vote on executive compensation and stockholder approval of any golden parachute payments not previously approved.

Further, Section 102(b)(1) of the JOBS Act exempts emerging growth companies from being required to comply with new or revised financial accounting standards until private companies (that is, those that have not had a Securities Act registration statement declared effective or do not have a class of securities registered under the Exchange Act) are required to comply with the new or revised financial accounting standards. The JOBS Act provides that a company can elect to opt out of the extended transition period and comply with the requirements that apply to non-emerging growth companies but any such election to opt out is irrevocable. The Company has elected not to opt out of such extended transition period which means that when a standard is issued or revised and it has different application dates for public or private companies, the Company, as an emerging growth company, can adopt the new or revised standard at the time private companies adopt the new or revised standard. This may make comparison of the Company’s financial statements with another public company that is neither an emerging growth company nor an emerging growth company that has opted out of using the extended transition period difficult or impossible because of the potential differences in accounting standards used.

## **Use of Estimates**

In preparing these financial statements in conformity with U.S. GAAP, the Company’s management makes estimates and assumptions that affect the reported amounts of assets and liabilities and disclosure of contingent assets and liabilities at the date of the financial statements and the reported expenses during the reporting period.

Making estimates requires management to exercise significant judgment. It is at least reasonably possible that the estimate of the effect of a condition, situation or set of circumstances that existed at the date of the financial statements, which management considered in formulating its estimate, could change in the near term due to one or more future confirming events. Accordingly, the actual results could differ significantly from those estimates.

## **Cash and Cash Equivalents**

The Company considers all short-term investments with an original maturity of three months or less when purchased to be cash equivalents. The Company had \$278,295 and \$125,303 in cash as of December 31, 2022 and December 31, 2021, respectively, and none in cash equivalents for both periods.

## **Investments Held in Trust Account**

As of December 31, 2022, the assets held in the Trust Account were held in cash and U.S. Treasury securities. The Company classifies its U.S. Treasury securities as trading securities in accordance with Financial Accounting Standards Board (“FASB”) Accounting Standards Codification (“ASC”) Topic 320, “Investments—Debt and Equity Securities.” Trading securities are presented on the balance sheets at fair value at the end of each reporting period. Gains and losses resulting from the change in fair value of these securities is included in gain on investments held in Trust Account in the accompanying statement of operations. The estimated fair values of all assets held in the Trust Account are determined using available market information and classified as Level 1 measurements.

## **Deferred Offering Costs**

The Company complies with the requirements of Financial Accounting Standards Board (the “FASB”) Accounting Standards Codification (the “ASC”) Topic 340-10-S99-1, “Other Assets and Deferred Costs – SEC Materials” (“ASC 340-10-S99”) and SEC Staff Accounting Bulletin Topic 5A, “Expenses of Offering”. Deferred offering costs were \$4,117,889 consisting principally of underwriting, legal, accounting and other expenses that are directly related to the IPO and charged to stockholders’ equity upon the completion of the IPO.

## Income Taxes

The Company follows the asset and liability method of accounting for income taxes under ASC 740, "Income Taxes." Deferred tax assets and liabilities are recognized for the estimated future tax consequences attributable to differences between the financial statements carrying amounts of existing assets and liabilities and their respective tax bases. Deferred tax assets and liabilities are measured using enacted tax rates expected to apply to taxable income in the years in which those temporary differences are expected to be recovered or settled. The effect on deferred tax assets and liabilities of a change in tax rates is recognized in income in the period that included the enactment date. Valuation allowances are established, when necessary, to reduce deferred tax assets to the amount expected to be realized. ASC 740 prescribes a recognition threshold and a measurement attribute for the financial statement recognition and measurement of tax positions taken or expected to be taken in a tax return. For those benefits to be recognized, a tax position must be more likely than not to be sustained upon examination by taxing authorities. The Company recognizes accrued interest and penalties related to unrecognized tax benefits as income tax expense. There were no unrecognized tax benefits and no amounts accrued for interest and penalties as of December 31, 2022. The Company is currently not aware of any issues under review that could result in significant payments, accruals or material deviation from its position. The Company is subject to income tax examinations by major taxing authorities since inception.

The Company has identified the United States as its only "major" tax jurisdiction.

The Company may be subject to potential examination by federal and state taxing authorities in the areas of income taxes. These potential examinations may include questioning the timing and amount of deductions, the nexus of income among various tax jurisdictions and compliance with federal and state tax laws. The Company's management does not expect that the total amount of unrecognized tax benefits will materially change over the next twelve months.

## Net Income (Loss) Per Share

Net income (loss) per share is computed by dividing net income (loss) by the weighted average number of shares of common stock outstanding during the period, excluding shares of common stock subject to forfeiture by the Initial Stockholders. Weighted average shares were reduced for the effect of the forfeiture of 112,500 Founder Shares as a result of the Underwriters' partial exercise of their over-allotment option on May 17, 2022. On June 3, 2022, the Sponsors executed cancellation notices to the transfer agent to forfeit the remaining 112,500 shares for no consideration. The calculation of diluted net income (loss) per share and related weighted average of the shares does not consider the effect of the warrants and rights issued in connection with the (i) IPO, and (ii) the private placement since the exercise of the warrants and rights are contingent upon the occurrence of future events. The warrants are exercisable to purchase 3,225,000 shares of Class A Common Stock in the aggregate, and the rights are exercisable to convert 806,250 shares of Class A Common Stock in the aggregate. At December 31, 2022, the Company did not have any dilutive securities and other contracts that could, potentially, be exercised or converted into shares of common stock and then share in the earnings of the Company. As a result, diluted income (loss) per share is the same as basic loss per share for the period presented.

The net income (loss) per share presented in the statements of operations is based on the following:

	<b>For the year ended December 31, 2022</b>	<b>For the period from February 25, 2021 (inception) to December 31, 2022</b>
Net income (loss)	\$ 141,931	\$ (1,357)
Accretion of common stock to redemption value	(10,540,369)	—
Subsequent measurement of common stock subject to redemption value	(928,520)	—
Net loss including accretion of common stock to redemption value	<u>\$ (11,326,958)</u>	<u>\$ (1,357)</u>

	For the Year Ended December 31, 2022		For the Period from February 25, 2021 (Inception) through December 31, 2021	
	Redeemable shares	Non- redeemable shares	Redeemable shares	Non- redeemable shares
Basic and diluted net income (loss) per common stock				
Numerator:				
Allocation of net loss including accretion of common stock	\$ (7,695,836)	\$ (3,631,122)	\$ —	\$ (1,357)
Subsequent measurement of common stock subject to redemption value	928,520	—	—	—
Accretion of common stock to redemption value	10,540,369	—	—	—
Allocation of net income (loss)	<u>\$ 3,773,053</u>	<u>\$ (3,631,122)</u>	<u>\$ —</u>	<u>\$ (1,357)</u>
Denominator:				
Basic and diluted weighted average shares outstanding	4,040,110	1,906,243	—	1,044,862
Basic and diluted net income (loss) per common stock	<u>\$ 0.93</u>	<u>\$ (1.90)</u>	<u>\$ —</u>	<u>\$ (0.00)</u>

### Concentration of Credit Risk

Financial instruments that potentially subject the Company to concentrations of credit risk consist of a cash account in a financial institution, which, at times, may exceed the Federal Depository Insurance Coverage of \$250,000. As of December 31, 2022 and December 31, 2021, the Company has not experienced losses on this account and management believes the Company is not exposed to significant risks on such account.

### Fair Value of Financial Instruments

The fair value of the Company's assets and liabilities, which qualify as financial instruments under ASC 825, "Financial Instruments," approximates the carrying amounts represented in the accompanying balance sheet, primarily due to their short-term nature.

### Warrants

The Company accounts for warrants as either equity-classified or liability-classified instruments based on an assessment of the warrant's specific terms and applicable authoritative guidance in FASB ASC 480, Distinguishing Liabilities from Equity ("ASC 480") and ASC 815, Derivatives and Hedging ("ASC 815"). The assessment considers whether the warrants are freestanding financial instruments pursuant to ASC 480, meet the definition of a liability pursuant to ASC 480, and whether the warrants meet all of the requirements for equity classification under ASC 815, including whether the warrants are indexed to the Company's own common shares and whether the warrant holders could potentially require "net cash settlement" in a circumstance outside of the Company's control, among other conditions for equity classification. This assessment, which requires the use of professional judgment, is conducted at the time of warrant issuance and as of each subsequent quarterly period end date while the warrants are outstanding. The Company determined that upon further review of the warrant agreement, the Public Warrants issued pursuant to the warrant agreement qualify for equity accounting treatment.

For issued or modified warrants that meet all of the criteria for equity classification, the warrants are required to be recorded as a component of equity at the time of issuance. For issued or modified warrants that do not meet all the criteria for equity classification, the warrants are required to be recorded as liabilities at their initial fair value on the date of issuance, and each balance sheet date thereafter. Changes in the estimated fair value of the warrants are recognized as a non-cash gain or loss on the statements of operations.

### Common Stock Subject to Possible Redemption

The Company accounts for its common stock subject to possible redemption in accordance with the guidance in ASC Topic 480 "Distinguishing Liabilities from Equity." Common stock subject to mandatory redemption (if any) are classified as a liability instrument and are measured at fair value. Conditionally redeemable common stock (including common stock that feature redemption rights that is either within the control of the holder or subject to redemption upon the occurrence of uncertain events not solely within the Company's control) is classified as temporary equity. At all other times, common stock is classified as stockholders' equity. The Company's common stock features certain redemption rights that are considered to be outside of the Company's control and subject to occurrence of uncertain future events. Accordingly, as of December 31, 2022, common stock subject to possible redemption are presented at redemption value of \$10.34 per share as temporary equity, outside of the shareholders' equity section of the Company's balance sheet. The Company recognizes changes in redemption value immediately as they occur and adjusts the carrying value of redeemable common stock to equal the redemption value at the end of each reporting period. Increases or decreases in the carrying amount of shares of redeemable common stock are affected by charges against additional paid in capital or accumulated deficit if additional paid in capital equals to zero.

## Recent Accounting Pronouncements

In August 2020, FASB issued Accounting Standards Update (“ASU”) 2020-06, Debt — Debt with Conversion and Other Options (Subtopic 470-20) and Derivatives and Hedging — Contracts in Entity’s Own Equity (Subtopic 815-40) (“ASU 2020-06”) to simplify accounting for certain financial instruments. ASU 2020-06 eliminates the current models that require separation of beneficial conversion and cash conversion features from convertible instruments and simplifies the derivative scope exception guidance pertaining to equity classification of contracts in an entity’s own equity. The new standard also introduces additional disclosures for convertible debt and freestanding instruments that are indexed to and settled in an entity’s own equity. ASU 2020-06 amends the diluted earnings per share guidance, including the requirement to use the if-converted method for all convertible instruments. ASU 2020-06 is effective January 1, 2024 for the Company and should be applied on a full or modified retrospective basis, with early adoption permitted beginning on January 1, 2021. The Company is currently assessing the impact, if any, that ASU 2020-06 would have on its financial position, results of operations or cash flows.

Management does not believe that any other recently issued, but not yet effective, accounting pronouncements, if currently adopted, would have a material effect on the Company’s financial statement.

## Note 3 — Initial Public Offering

Pursuant to the IPO on May 17, 2022, the Company sold 6,450,000 Public Units which included 450,000 units issued upon the partial exercise of the underwriters’ over-allotment option. Each Public Unit consists of one share of Class A common stock, \$0.0001 par value per share, one-half of one redeemable warrant (the “Public Warrants”), each whole Public Warrant entitling the holder thereof to purchase one share of Class A Common Stock at an exercise price of \$11.50 per share, and one right (the “Public Rights”), each one Public Right entitling the holder thereof to exchange for one-eighth (1/8) of one Class A Common Stock upon the completion of the Company’s initial Business Combination. Because the Warrants may only be exercised for whole numbers of shares, only an even number of Warrants may be exercised. The Warrants will become exercisable on the later of 30 days after the completion of the Company’s initial Business Combination or 12 months from the closing of the IPO, and will expire five years after the completion of the Company’s initial Business Combination or earlier upon redemption or liquidation. Each Right entitles the holder thereof to receive one-eighth (1/8) of one share of Class A common stock at the closing of a Business Combination. The Company will not issue fractional shares in connection with an exchange of Rights. Fractional shares will either be rounded down to the nearest whole share or otherwise addressed in accordance with the applicable provisions of the Delaware General Corporation Law, or DGCL. As a result, the holder of the Rights must hold Rights in multiples of eight (8) in order to receive shares of Class A common stock for all of their rights upon closing of a Business Combination.

All of the 6,450,000 Public Shares sold as part of the Public Units in the IPO contain a redemption feature which allows for the redemption of such Public Shares if there is a stockholder vote or tender offer in connection with the Business Combination and in connection with certain amendments to the Company’s amended and restated certificate of incorporation, or in connection with the Company’s liquidation. In accordance with the SEC and its staff’s guidance on redeemable equity instruments, which has been codified in ASC 480-10-S99, redemption provisions not solely within the control of the Company require common stock subject to redemption to be classified outside of permanent equity.

The Company’s redeemable Class A common stock is subject to SEC and its staff’s guidance on redeemable equity instruments, which has been codified in ASC 480-10-S99. If it is probable that the equity instrument will become redeemable, the Company has the option to either accrete changes in the redemption value over the period from the date of issuance (or from the date that it becomes probable that the instrument will become redeemable, if later) to the earliest redemption date of the instrument or to recognize changes in the redemption value immediately as they occur and adjust the carrying amount of the instrument to equal the redemption value at the end of each reporting period. The Company has elected to recognize the changes immediately. The accretion or remeasurement is treated as a deemed dividend (i.e., a reduction to retained earnings, or in absence of retained earnings, additional paid-in capital).

As of December 31, 2022, the shares of Class A common stock reflected on the balance sheet are reconciled in the following table.

	<b>As of</b>
	<b>December 31, 2022</b>
Gross proceeds	\$ 64,500,000
Less:	
Proceeds allocated to Public Warrants	(322,500)
Proceeds allocated to Public Rights	(5,160,000)
Offering costs of Public Shares	(3,767,868)
Plus:	
Accretion of carrying value to redemption value	11,468,889
Common stock subject to possible redemption	<u>\$ 66,718,520</u>

#### **Note 4 — Private Placement**

Simultaneously with the closing of the IPO, the Company sold an aggregate of 398,892 Private Shares, including 349,032 shares to Sponsor A and 49,860 shares to Sponsor B, at a purchase price of \$10.00 per Private Share, generating gross proceeds of \$3,988,920 (including \$3,490,320 from Sponsor A and \$498,600 from Sponsor B). The net proceeds from the Private Shares were added to the proceeds from the IPO to be held in the Trust Account. If the Company does not complete a Business Combination within the Combination Period, the proceeds from the sale of the Private Shares will be used to fund the redemption of the Public Shares (subject to the requirements of applicable law), and the Private Share will expire worthless.

#### **Note 5 — Related Party Transactions**

##### **Promissory Note - Related Party**

On March 19, 2021, Sponsor A agreed to loan the Company up to an aggregate amount of \$400,000 to be used, in part, for transaction costs incurred in connection with IPO (the “Promissory Note”). The Promissory Note is unsecured, interest-free and due at the earlier of August 31, 2022 or closing of the IPO. The Company repaid the \$350,000 outstanding balance upon the closing of the IPO on May 17, 2022.

##### **Related Party Loans**

In addition, in order to finance transaction costs in connection with an intended initial Business Combination, the Initial Stockholders or their affiliates may, but are not obligated to, loan us funds as may be required. If the Company completes an initial Business Combination, it would repay such loaned amounts (the “Working Capital Loans”). In the event that the initial Business Combination does not close, the Company may use a portion of the working capital held outside the U.S. based Trust Account to repay such loaned amounts but no proceeds from our Trust Account would be used for such repayment. Certain amount of such loans may be convertible into working capital shares at \$10.00 per share at the option of the lender. The working capital shares would be identical to the shares sold in the private placement. As of December 31, 2022, the Company had no borrowings under the Working Capital Loans.

##### **Founder Shares**

On April 7, 2021, Sponsor A and Sponsor B acquired 1,357,000 shares and 80,500 shares of Class B common stock, respectively. On May 28, 2021, Sponsor A and Sponsor B surrendered 271,400 and 16,100 shares of Class B common stock, respectively, without consideration. On December 22, 2021, the Company effected a 1.5 for 1 stock split of Class B common stock resulting the Sponsors holding 1,725,000 shares of Class B common stock. On December 28, 2021, the Sponsors converted their shares of Class B common stock into 1,725,000 shares of Class A common stock on a one-for-one basis (up to 225,000 shares of which are subject to forfeiture to the extent that the underwriters’ over-allotment option is not exercised in full or in part). As a result, Sponsor A owns 1,628,400 shares of Class A common stock for an aggregate consideration of \$23,600 and Sponsor B owns 96,600 shares of Class A common stock for an aggregate consideration of \$1,400 (collectively “Founder Shares”) for an aggregate consideration of \$25,000, or approximately \$0.01 per share. As a result of the underwriters’ partial exercise of their over-allotment option on May 17, 2022, 112,500 Founder Shares were subject to forfeiture. On June 3, 2022, the Sponsors executed cancellation notices to the transfer agent to forfeit the remaining 112,500 shares for no consideration.



The Initial Stockholders have agreed, subject to certain limited exceptions, not to transfer, assign or sell any of their Founder Shares until, with respect to 50% of the Founder Shares, the earlier of six months after the consummation of a Business Combination and the date on which the closing price of the Class A common stock equals or exceeds \$12.50 per share (as adjusted for stock splits, stock dividends, reorganizations, recapitalizations and the like) for any 20 trading days within a 30-trading day period commencing after a Business Combination and, with respect to the remaining 50% of the insider shares, until the six months after the consummation of a Business Combination, or earlier, in either case, if, subsequent to a Business Combination, the Company completes a liquidation, merger, stock exchange or other similar transaction which results in all of the Company's stockholders having the right to exchange their shares of common stock for cash, securities or other property.

#### **Administrative Services Agreement**

The Company has agreed, commencing on May 12, 2022, to pay Sponsor A up to \$10,000 per month for office space, administrative and shared personnel support services. However, pursuant to the terms of such agreement, the Company may delay payment of such monthly fee upon a determination by the audit committee that there are insufficient funds held outside the trust to pay actual or anticipated expenses in connection with the initial Business Combination. Any such unpaid amount will accrue without interest and be due and payable no later than the date of the consummation of the initial Business Combination. This arrangement will terminate upon the earlier of (a) completion of a Business Combination or (b) twelve months after the completion of the IPO. The Company incurred \$76,129 and \$0, respectively, in fees for these services, of which \$76,129 and \$0 were included in accrued expenses in the accompanying balance sheets at December 31, 2022 and December 31, 2021, respectively.

#### **Note 6 — Commitments and Contingencies**

##### **Registration Rights**

The holders of the Founder Shares, Private Shares and working capital shares issuable upon conversion of working capital loans, if any, will be entitled to registration rights pursuant to a registration rights agreement to be signed prior to or on the effective date of this offering, requiring us to register such securities for resale. The holders of the majority of these securities are entitled to make up to three demands, excluding short form demands, that the Company registers such securities. In addition, the holders have certain "piggy-back" registration rights with respect to registration statements filed subsequent to the completion of the initial Business Combination and rights to require the Company to register for resale such securities pursuant to Rule 415 under the Securities Act. The Company will bear the expenses incurred in connection with the filing of any such registration statements.

##### **Underwriting Agreement**

The Company has granted Prime Number Capital, LLC and WestPark Capital, Inc. (collectively referred to as the "Underwriters"), a 45-day option from the date of the prospectus to purchase up to 900,000 Public Units (one share of Class A common stock, one-half (1/2) of one redeemable Warrant, and one Right) ("Over-allotment Units") to cover over-allotments, if any, at the IPO price less the underwriting discounts and commissions. On May 17, 2022, simultaneously with the closing of the IPO, the Underwriters partially exercised its over-allotment option to purchase 450,000 Over-allotment Units, generating gross proceeds to the Company of \$4,500,000.

The Underwriters were paid a cash underwriting discount of 2.0% of the gross proceeds of the IPO, or \$1,290,000. In addition, the underwriters will be entitled to a deferred fee of 3.5% of the gross proceeds of the IPO, or \$2,257,500 (the "Deferred Underwriting Commissions"), which will be paid upon the closing of a Business Combination from the amounts held in the Trust Account, subject to the terms of the underwriting agreement.

#### **Note 7 — Stockholders' Equity**

**Preferred Stock** -- The Company is authorized to issue 400,000 shares (reduced from 1,000,000 shares subsequent to IPO on May 10, 2022) of preferred stock with a par value of \$0.0001 per share and with such designations, voting and other rights and preferences as may be determined from time to time by the Company's board of directors. As of December 31, 2022, there was no preferred stock issued or outstanding.

**Class A Common Stock** — The Company is authorized to issue 20,000,000 shares (reduced from 50,000,000 shares subsequent to IPO on May 10, 2022) of Class A common stock with a par value of \$0.0001 per share. On December 28, 2021, the Sponsors converted their shares of Class B common stock into 1,725,000 shares of Class A common stock on a one-for-one basis. As a result of the Underwriters' partial exercise of their over-allotment option on May 17, 2022, 112,500 Founder Shares were forfeited on May 23, 2022. As of December 31, 2022, there were 2,011,392 shares of common stock issued and outstanding (excluding 6,450,000 shares subject to possible redemption), so that the Initial Stockholders own approximately 20% of the issued and outstanding shares after the IPO.

**Class B Common Stock** -- The Company is authorized to issue 100,000 shares (reduced from 2,000,000 shares subsequent to IPO on May 10, 2022) of Class B common stock with a par value of \$0.0001 per share. On December 22, 2021, the Company effected a 1.5 for 1 stock split of our Class B common stock so that the Sponsors owned an aggregate of 1,725,000 shares of Class B common stock. On December 28, 2021, the Sponsors converted their shares of Class B common stock into 1,725,000 shares of Class A common stock on a one-for-one basis (up to 225,000 shares of which are subject to forfeiture depending on the extent to which the underwriter's over-allotment option is exercised). As of December 31, 2022, there was no Class B common stock issued or outstanding.

**Rights** — Each holder of a right (the "Rights") will receive one-eighth (1/8) of one share of Class A common stock upon consummation of a Business Combination, even if the holder of such Right redeemed all shares held by it in connection with a Business Combination. No fractional shares will be issued upon conversion of the rights. No additional consideration will be required to be paid by a holder of rights in order to receive its additional shares upon consummation of a Business Combination, as the consideration related thereto has been included in the unit purchase price paid for by investors in the IPO. If the Company enters into a definitive agreement for a Business Combination in which the Company will not be the surviving entity, the definitive agreement will provide for the holders of rights to receive the same per share consideration the holders of the common stock will receive in the transaction on an as-converted into common stock basis and each holder of a Right will be required to affirmatively convert its Rights in order to receive 1/8 share underlying each Right (without paying additional consideration). The shares issuable upon conversion of the Rights will be freely tradable (except to the extent held by affiliates of the Company).

If the Company is unable to complete a Business Combination within the Combination Period and the Company liquidates the funds held in the Trust Account, holders of Rights will not receive any of such funds with respect to their Rights, nor will they receive any distribution from the Company's assets held outside of the Trust Account with respect to such Rights, and the Rights will expire worthless. Further, there are no contractual penalties for failure to deliver securities to the holders of the Rights upon consummation of a Business Combination. Additionally, in no event will the Company be required to net cash settle the Rights. Accordingly, the Rights may expire worthless.

**Warrants** — Each redeemable warrant (the "Warrant") entitles the holder thereof to purchase one share of common stock at a price of \$11.50 per share, subject to adjustment as described in this prospectus. The Warrants will become exercisable on the later of the completion of an initial Business Combination and 12 months from the closing of the IPO. However, no Public Warrants will be exercisable for cash unless the Company has an effective and current registration statement covering the issuance of the common stock issuable upon exercise of the Warrants and a current prospectus relating to such common stock. Notwithstanding the foregoing, if a registration statement covering the issuance of the common stock issuable upon exercise of the Public Warrants is not effective within 90 days from the closing of the Company's initial Business Combination, warrant holders may, until such time as there is an effective registration statement and during any period when we shall have failed to maintain an effective registration statement, exercise Warrants on a cashless basis pursuant to an available exemption from registration under the Securities Act. If an exemption from registration is not available, holders will not be able to exercise their Warrants on a cashless basis. The Warrants will expire five years from the closing of the Company's initial Business Combination at 5:00 p.m., New York City time or earlier redemption.

In addition, if (x) the Company issues additional shares of Class A common stock or equity-linked securities for capital raising purposes in connection with the closing of the Company's initial Business Combination at an issue price or effective issue price of less than \$9.20 per share (with such issue price or effective issue price to be determined in good faith by the board of directors and, in the case of any such issuance to our founders or their affiliates, without taking into account any founder shares held by founders or such affiliates, as applicable, prior to such issuance) (the "Newly Issued Price"), (y) the aggregate gross proceeds from such issuances represent more than 60% of the total equity proceeds, and interest thereon, available for the funding of the Company's initial Business Combination (net of redemption), and (z) the volume weighted average trading price of the Company's Class A common stock during the 20 trading day period starting on the trading day prior to the day on which the Company consummates its initial Business Combination (such price, the "Market Price") is below \$9.20 per share, the exercise price of the Warrants will be adjusted (to the nearest cent) to be equal to 115% of the Market Price, and the \$16.50 per share redemption trigger price described below will be adjusted (to the nearest cent) to be equal to 180% of the greater of the Market Value and the Newly Issued Price.

The Company may redeem the outstanding Public Warrants at any time while the Warrants are exercisable:

- in whole and not in part;
- at a price of \$0.01 per Warrant;
- upon a minimum number of 30 days' prior written notice of redemption, which the Company refers to as the 30-day redemption period;
- if, and only if, the last reported sale price of the Company's common stock equals or exceeds \$16.50 per share (as adjusted for stock splits, stock dividends, reorganizations, recapitalizations and the like) for any 20 trading days within a 30-trading day period ending on the third trading day prior to the date on which the Company sends the notice of redemption to the to the warrant holders.

If the Company calls the Public Warrants for redemption, management will have the option to require all holders that wish to exercise the Public Warrants to do so on a "cashless basis," as described in the warrant agreement. In such event, each holder would pay the exercise price by surrendering the whole warrants for that number of shares of common stock equal to the quotient obtained by dividing (x) the product of the number of shares of common stock underlying the warrants, multiplied by the difference between the exercise price of the warrants and the "fair market value" (defined below) by (y) the fair market value. The "fair market value" shall mean the average reported last sale price of the common stock for the 10 trading days ending on the third trading day prior to the date on which the notice of redemption is sent to the holders of warrants.

Except as described above, no warrants will be exercisable and the Company will not be obligated to issue common stock unless at the time a holder seeks to exercise such warrant, a prospectus relating to the Class A common stock issuable upon exercise of the warrants is current and the common stock have been registered or qualified or deemed to be exempt under the securities laws of the state of residence of the holder of the warrants. Under the terms of the warrant agreement, the Company has agreed to use its best efforts to meet these conditions and to maintain a current prospectus relating to the common stock issuable upon exercise of the warrants until the expiration of the warrants. However, the Company cannot assure that it will be able to do so and, if the Company does not maintain a current prospectus relating to the common stock issuable upon exercise of the warrants, holders will be unable to exercise their warrants and the Company will not be required to settle any such warrant exercise. If the prospectus relating to the Class A common stock issuable upon the exercise of the warrants is not current or if the common stock is not qualified or exempt from qualification in the jurisdictions in which the holders of the warrants reside, the Company will not be required to net cash settle or cash settle the warrant exercise, the warrants may have no value, the market for the warrants may be limited and the warrants may expire worthless.

#### **Note 8 — Fair Value Measurements**

The fair value of the Company's consolidated financial assets and liabilities reflects management's estimate of amounts that the Company would have received in connection with the sale of the assets or paid in connection with the transfer of the liabilities in an orderly transaction between market participants at the measurement date. In connection with measuring the fair value of its assets and liabilities, the Company seeks to maximize the use of observable inputs (market data obtained from independent sources) and to minimize the use of unobservable inputs (internal assumptions about how market participants would price assets and liabilities). The following fair value hierarchy is used to classify assets and liabilities based on the observable inputs and unobservable inputs used in order to value the assets and liabilities:

- Level 1: Quoted prices in active markets for identical assets or liabilities. An active market for an asset or liability is a market in which transactions for the asset or liability occur with sufficient frequency and volume to provide pricing information on an ongoing basis.
- Level 2: Observable inputs other than Level 1 inputs. Examples of Level 2 inputs include quoted prices in active markets for similar assets or liabilities and quoted prices for identical assets or liabilities in markets that are not active.
- Level 3: Unobservable inputs based on the assessment of the assumptions that market participants would use in pricing the asset or liability.

The following table presents information about the Company's assets that are measured at fair value on a recurring basis at December 31, 2022 and indicates the fair value hierarchy of the valuation inputs the Company utilized to determine such fair value.

	December 31, 2022	Quoted Prices in Active Markets (Level 1)	Significant Other Observable Inputs (Level 2)	Significant Other Unobservable Inputs (Level 3)
<b>Assets</b>				
Marketable Securities in the Trust Account	66,718,520	66,718,520	—	—

**Note 9 — Income Taxes**

The Company's net deferred tax assets (liabilities) are as follows:

	December 31, 2022	December 31, 2021
Deferred tax asset (liability)		
Startup/Organization Expenses	\$ 8,512	\$ —
Unrealized gain on investments held in Trust Account	(45,353)	—
Amortization of startup cost	(349)	—
Total deferred tax asset (liability)	(37,190)	—
Valuation allowance	—	—
Deferred tax asset (liability), net of allowance	\$ (37,190)	\$ —

The income tax provision consists of the following:

	For the Year ended December 31, 2022	For the period from February 25, 2021 (inception) through December 31, 2021
<b>Federal</b>		
Current	\$ 112,446	\$ —
Deferred	37,190	—
<b>State</b>		
Current	\$ —	\$ —
Deferred	—	—
Change in valuation allowance	—	—
Income tax provision	\$ 149,636	\$ —

A reconciliation of the Company's statutory income tax rate to the Company's effective income tax rate is as follows:

	For the Year ended December 31, 2022	For the period from February 25, 2021 (inception) through December 31, 2021
Income at U.S. statutory rate	21.00%	21.00%
State taxes, net of federal benefit	0.00%	0.00%
Transaction costs	30.42%	0.00%
True up in deferred tax asset balance	(0.10)%	0.00%
Change in valuation allowance	0.00%	0.00%
	51.32%	21.00%

As of December 31, 2022, the Company did not have any U.S. federal and state net operating loss carryovers available to offset future taxable income.

In assessing the realization of the deferred tax assets, management considers whether it is more likely than not that some portion of all of the deferred tax assets will not be realized. The ultimate realization of deferred tax assets is dependent upon the generation of future taxable income during the periods in which temporary differences representing net future deductible amounts become deductible. Management considers the scheduled reversal of deferred tax liabilities, projected future taxable income and tax planning strategies in making this assessment. After consideration of all of the information available, management believes that significant uncertainty exists with respect to future realization of the deferred tax assets and has therefore established a full valuation allowance. The change in the valuation allowance was \$0 for the year ended December 31, 2022.

The provisions for U.S. federal and state income taxes were \$149,636 (including deferred income tax provision of \$37,190) and \$0 for the year ended December 31, 2022 and for the period from February 25, 2021 (inception) to December 31, 2021, respectively. The Company's tax returns for the year ended December 31, 2022 and 2021 remain open and subject to examination.

#### **Note 10 — Subsequent Events**

In accordance with ASC 855, "Subsequent Events," the Company evaluated subsequent events and transactions that occurred after the balance sheet date up to the date that the financial statements were issued. Based on the review as further disclosed in the footnotes, management identified the following subsequent event requiring disclosure in the financial statements.

On February 2, 2023, Prime Number Holding Limited, formed as the PubCo on December 28, 2022, and Prime Number New Sub Pte. Ltd., formed as New SubCo on January 25, 2023, joined as parties to the Merger Agreement.

On February 10, 2023, the draft registration statement on Form F-4 was submitted with the SEC regarding the proposed Merger between the Company and noco-noco.

#### **Note 11 — Events (Unaudited) Subsequent to the Date of the Independent Auditor's Report**

On April 23, 2023, DBG Global Limited, a member of Sponsor A, agreed to loan the Company up to \$24,000 to be used for a portion of the working capital. This loan is non-interest bearing, unsecured and is due at the earlier of (1) the date on which the Company consummates its initial business combination or (2) the date on which the Company liquidates.

On May 15, 2023, the Company held a special meeting of stockholders (the "Special Meeting"). At the Special Meeting, the stockholders of the Company approved the proposal to amend the Company's then effective Amended and Restated Certificate of Incorporation to (i) allow the Company until May 17, 2023 to consummate an initial business combination, and to (ii) elect to extend the period to consummate an initial business combination up to six times, each by an additional one-month period (each a "Monthly Extension"), for a total of up to six months to November 17, 2023 ("Extended Termination Date"), by depositing to the Company's Trust Account the amount lesser of (i) \$125,000 for each one-month extension or (ii) \$0.045 for each Public Share for each one-month extension (the "Extension Amendment Proposal").

On May 15, the Company released a press release announcing its intent to extend the deadline that it must complete its initial business combination from May 17, 2023 to June 17, 2023 and its intent to cause the Sponsor or its designee to deposit an aggregate of \$125,000 into the Trust Account.

In connection with the votes to approve the Extension Amendment Proposal, 1,537,701 Public Shares of the Company were tendered for redemption. As of the date of this proxy statement/prospectus, all such Public Shares are in the process of redemption by our transfer agent, VStock Transfer, LLC, which shall result in a total of 4,912,299 Public Shares remaining after the consummation of such process.

On May 17, 2023, \$125,000 was deposited into the Trust Account for the public stockholders to effectuate the first Monthly Extension. Accordingly, the Company issued an unsecured promissory note of \$208,594.15 (the "noco-noco Note") noco-noco to evidence the payments made by noco-noco for the first Monthly Extension payment and 50% of the registration fee for filing of a registration statement/proxy statement in Form F-4 with the U.S. securities and exchange commission. The noco-noco Note bears no interest and is payable in full upon the earlier to occur of (i) the consummation of an initial business combination or (ii) the date of expiry of the term of the Company, in cash or shares of the Company at \$10.00 per share, at the discretion of the note holder.

On June 14, 2023, an additional aggregate of \$125,000 was deposited by noco-noco upon request by the sponsors of the Company, into the trust account of the Company, as a result of which, the Company has extended the period of time it has to consummate its initial business combination by one month from June 17, 2023 to July 17, 2023. This is the second of the six Monthly Extension permitted under the Existing PNAC Charter.

In connection with the Monthly Extension Payment, the Company issued an unsecured promissory note of \$125,000 (the "June noco-noco Note") to noco-noco. The June noco-noco Note is non-interest bearing and payable (subject to the waiver against trust provisions) on the earlier of (i) consummation of the Company's initial business combination and (ii) the date of the liquidation of the Company. The principal balance may be prepaid at any time, at the election of the Company. The holder of the June noco-noco Note has the right, but not the obligation, to convert the Note, in whole or in part, respectively, into private placement shares (the "Working Capital Shares") of the Company, by providing the Company with written notice of its intention to convert the Note at least two business days prior to the closing of the Company's initial business combination. The number of Working Capital Shares to be received by the holder in connection with such conversion shall be an amount determined by dividing (x) the sum of the outstanding principal amount payable to the holder, by (y) \$10.00.

---

**BUSINESS COMBINATION AGREEMENT**

by and among

**Prime Number Acquisition I Corp.,**

as Acquiror,

**THE ACQUISITION ENTITIES NAMED HEREIN,**

as Acquisition Entities,

**NOCO-NOCO PTE. LTD.,**

as the Company,

and

**THE SHAREHOLDERS OF THE COMPANY NAMED HEREIN,**

as the Sellers

dated as of December 29, 2022

---

---

## TABLE OF CONTENTS

	<b>Page</b>
<b>ARTICLE I</b>	
<b>CERTAIN DEFINITIONS</b>	<b>A-4</b>
Section 1.1. Definitions	A-4
Section 1.2. Other Definitions	A-17
Section 1.3. Construction	A-19
Section 1.4. Knowledge	A-19
<b>ARTICLE II</b>	
<b>THE MERGER; MERGER CLOSING</b>	<b>A-20</b>
Section 2.1. The Merger	A-20
Section 2.2. Effects of the Merger	A-20
Section 2.3. Merger Closing; Merger Effective Time	A-20
Section 2.4. Effect of Merger on Issued Securities of Acquiror, PubCo and Merger Sub	A-21
Section 2.5. Governing Documents of Surviving Corporation	A-23
Section 2.6. Directors and Officers of the Surviving Corporation	A-23
<b>ARTICLE III</b>	
<b>SHARE EXCHANGE</b>	<b>A-24</b>
Section 3.1. Exchange of Company Ordinary Shares	A-24
Section 3.2. Exchange Consideration	A-24
Section 3.3. Share Exchange Closing	A-24
Section 3.4. New SubCo Governance	A-25
Section 3.5. Transaction Expense Statements	A-25
<b>ARTICLE IV</b>	
<b>REPRESENTATIONS AND WARRANTIES OF THE SELLERS</b>	<b>A-26</b>
Section 4.1. Organization and Standing	A-26
Section 4.2. Due Authorization	A-26
Section 4.3. Ownership	A-27
Section 4.4. No Conflict	A-27
Section 4.5. Governmental Authorities; Consents	A-27

**TABLE OF CONTENTS**  
**(continued)**

	<b>Page</b>
Section 4.6. Litigation	A-27
Section 4.7. No Additional Representations	A-28
 <b>ARTICLE V</b>  	
<b>REPRESENTATIONS AND WARRANTIES OF THE COMPANY</b>	<b>A-28</b>
Section 5.1. Company Organization	A-28
Section 5.2. Subsidiaries	A-28
Section 5.3. Due Authorization	A-29
Section 5.4. No Conflict	A-29
Section 5.5. Governmental Authorities; Consents	A-30
Section 5.6. Capitalization of the Company	A-30
Section 5.7. Capitalization of Subsidiaries	A-31
Section 5.8. Statutory Registers	A-31
Section 5.9. Financial Statements; Internal Controls	A-32
Section 5.10. Undisclosed Liabilities	A-33
Section 5.11. Litigation and Proceedings	A-33
Section 5.12. Legal Compliance	A-34
Section 5.13. Contracts; No Defaults	A-34
Section 5.14. Company Benefit Plans	A-37
Section 5.15. Labor Relations; Employees	A-37
Section 5.16. Taxes	A-39
Section 5.17. Insurance	A-40
Section 5.18. Licenses	A-40
Section 5.19. Equipment and Other Tangible Property	A-41
Section 5.20. Real Property	A-41
Section 5.21. Intellectual Property	A-42
Section 5.22. Privacy and Cybersecurity	A-44
Section 5.23. Environmental Matters	A-44
Section 5.24. Absence of Changes	A-45
Section 5.25. Anti-Corruption Compliance	A-45



**TABLE OF CONTENTS**  
**(continued)**

	<b>Page</b>
Section 5.26. Anti-Money Laundering, Sanctions and International Trade Compliance	A-45
Section 5.27. Proxy/Registration Statement	A-46
Section 5.28. Vendors.	A-46
Section 5.29. Government Contracts	A-47
Section 5.30. Sufficiency of Assets	A-47
Section 5.31. Investment Company	A-47
Section 5.32. Brokers' Fees	A-47
Section 5.33. No Additional Representations or Warranties	A-47
Section 5.34. Investigation	A-47

**ARTICLE VI**

<b>REPRESENTATIONS AND WARRANTIES OF ACQUIROR</b>	<b>A-48</b>
Section 6.1. Acquiror Organization	A-48
Section 6.2. Due Authorization	A-48
Section 6.3. No Conflict	A-49
Section 6.4. Litigation and Proceedings	A-49
Section 6.5. SEC Filings	A-49
Section 6.6. Internal Controls; Listing; Financial Statements	A-50
Section 6.7. Governmental Authorities; Consents	A-51
Section 6.8. Trust Account	A-52
Section 6.9. Investment Company Act; JOBS Act	A-52
Section 6.10. Absence of Changes	A-52
Section 6.11. No Undisclosed Liabilities	A-53
Section 6.12. Capitalization of Acquiror	A-53
Section 6.13. Brokers' Fees	A-54
Section 6.14. Indebtedness	A-54
Section 6.15. Taxes	A-54
Section 6.16. Business Activities	A-56
Section 6.17. Nasdaq Stock Market Quotation	A-56
Section 6.18. Proxy/Registration Statement	A-57

**TABLE OF CONTENTS**  
**(continued)**

	<b>Page</b>
Section 6.19. Transaction Financing	A-57
Section 6.20. No Outside Reliance	A-57
Section 6.21. No Additional Representation or Warranties	A-58

**ARTICLE VII**

**REPRESENTATIONS AND WARRANTIES OF THE ACQUISITION ENTITIES** **A-58**

Section 7.1. Organization	A-58
Section 7.2. Due Authorization	A-58
Section 7.3. No Conflict	A-59
Section 7.4. Litigation and Proceedings	A-59
Section 7.5. Governmental Authorities; Consents	A-60
Section 7.6. Capitalization of Acquisition Entities	A-60
Section 7.7. Brokers' Fees	A-60
Section 7.8. Business Activities	A-60
Section 7.9. Consideration Shares	A-61
Section 7.10. Foreign Private Issuer and Emerging Growth Company	A-61
Section 7.11. Investment Company Act	A-61
Section 7.12. Intended Tax Treatment	A-61

**ARTICLE VIII**

**COVENANTS OF THE COMPANY & THE SELLERS** **A-61**

Section 8.1. Company Conduct of Business	A-61
Section 8.2. Inspection	A-65
Section 8.3. Preparation and Delivery of Additional Company Financial Statements	A-65
Section 8.4. Alternative Proposals	A-66
Section 8.5. Exchange Listing	A-66
Section 8.6. Notice of Developments	A-66
Section 8.7. No Trading	A-67
Section 8.8. Support of Share Exchange	A-67

**TABLE OF CONTENTS**  
**(continued)**

	<b>Page</b>
<b>ARTICLE IX</b>	
<b>COVENANTS OF ACQUIROR PARTIES</b>	<b>A-67</b>
Section 9.1. Trust Account Proceeds	A-67
Section 9.2. Nasdaq Listing	A-68
Section 9.3. No Solicitation	A-68
Section 9.4. Conduct of Business	A-68
Section 9.5. Public Filings	A-70
Section 9.6. Shareholder Litigation	A-70
Section 9.7. Section 16 Matters	A-71
Section 9.8. PubCo Equity Plan	A-71
Section 9.9. PubCo Charter	A-71
Section 9.10. Support of Share Exchange	A-71
Section 9.11. Notice of Development	A-71
Section 9.12. Transaction Financing Efforts	A-72
<b>ARTICLE X</b>	
<b>JOINT COVENANTS</b>	<b>A-72</b>
Section 10.1. Regulatory Approvals; Other Filings	A-72
Section 10.2. Proxy/Registration Statement	A-73
Section 10.3. Support of Transaction	A-77
Section 10.4. Public Announcements	A-77
Section 10.5. Confidential Information	A-78
Section 10.6. Transfer Taxes	A-79
Section 10.7. Tax Free Reorganization Matters	A-80
Section 10.8. Cooperation; Consultation	A-80
Section 10.9. Transaction Financing	A-80
Section 10.10. Joining Seller	A-81
Section 10.11. Key Person Agreements.	A-81
Section 10.12. Post-Combination Directors and Officers of PubCo	A-81
Section 10.13. D&O Indemnification and Insurance	A-82

**TABLE OF CONTENTS**  
**(continued)**

	<b>Page</b>
Section 10.14. Antitrust Laws	A-83
Section 10.15. Shareholder Litigation	A-84
<b>ARTICLE XI</b>	
<b>CONDITIONS TO OBLIGATIONS</b>	<b>A-85</b>
Section 11.1. Conditions of each Party's Obligations	A-85
Section 11.2. Conditions to Obligations of Acquiror, Merger Sub and PubCo at Merger Closing	A-86
Section 11.3. Conditions to Obligations of PubCo, New SubCo, the Company and the Sellers at Share Exchange Closing	A-86
Section 11.4. Additional Conditions to the Obligations of PubCo and New SubCo at Share Exchange Closing.	A-87
Section 11.5. Additional Conditions to the Obligations of the Company and the Sellers at Share Exchange Closing	A-87
Section 11.6. Frustration of Conditions	A-88
<b>ARTICLE XII</b>	
<b>TERMINATION/EFFECTIVENESS</b>	<b>A-89</b>
Section 12.1. Termination	A-89
Section 12.2. Effect of Termination	A-90
<b>ARTICLE XIII</b>	
<b>MISCELLANEOUS</b>	<b>A-90</b>
Section 13.1. Trust Account Waiver	A-90
Section 13.2. Waiver	A-91
Section 13.3. Notices	A-91
Section 13.4. Assignment	A-92
Section 13.5. Rights of Third Parties	A-92
Section 13.6. Expenses	A-92
Section 13.7. Headings; Counterparts	A-92
Section 13.8. Electronic Execution of the Agreement and Certain Other Documents	A-93
Section 13.9. Company Disclosure Letter	A-93

**TABLE OF CONTENTS**  
**(continued)**

	<b>Page</b>
Section 13.10. Entire Agreement	A-93
Section 13.11. Amendments	A-93
Section 13.12. Severability	A-94
Section 13.13. Governing Law	A-94
Section 13.14. Jurisdiction; Waiver of Jury Trial	A-94
Section 13.15. Enforcement	A-95
Section 13.16. Non-Recourse	A-95
Section 13.17. Non-Survival of Representations, Warranties and Covenants	A-95
Section 13.18. New SubCo	A-96
Section 13.19. PubCo	A-96

**Annex I** Allocation Schedule

**Exhibits**

Exhibit A Form of Lock-up Agreement
Exhibit B Form of Registration Rights Agreement
Exhibit C Form of Warrant Assumption Agreement
Exhibit D Form of Certificate of Merger
Exhibit E Form of PubCo ESOP
Exhibit F Form of Post-Combination PubCo Charter
Exhibit G Form of BCA Joinder

## **BUSINESS COMBINATION AGREEMENT**

This Business Combination Agreement, dated as of December 29, 2022 (this “Agreement”), is made and entered into by and among Prime Number Acquisition I Corp., a Delaware corporation (“Acquiror”), PubCo (as defined below and upon the delivery of its signature page pursuant to Section 13.19), Prime Number Merger Sub Inc., a Delaware corporation formed to become a wholly-owned subsidiary of PubCo (the “Merger Sub”), New SubCo (as defined below and upon the delivery of its signature page pursuant to Section 13.18), NOCO-NOCO PTE. LTD., a Singapore private company limited by shares, with its Unique Entity Number being 201924194K (the “Company”), and the shareholders of the Company named on Annex I hereto as of the date hereof (each of which is a Company Insider (as defined below), such shareholders, the “Signing Sellers”) and the shareholders of the Company that join this Agreement pursuant to Section 10.10 after the date hereof (such shareholders, the “Joining Sellers”, together with the Signing Sellers, the “Sellers”).

### **RECITALS**

**WHEREAS**, Acquiror is a blank check company incorporated as a Delaware corporation and incorporated for the purpose of effecting a merger, share exchange, asset acquisition, stock purchase, reorganization or similar business combination with one or more businesses;

**WHEREAS**, a Cayman Islands exempted company incorporated for the purpose of making acquisitions and investments, with the objective of acting as the publicly traded holding company for its subsidiaries (“PubCo”), and PubCo will become a party to this Agreement by delivering its signature page to this Agreement pursuant to Section 13.19;

**WHEREAS**, Merger Sub is a newly incorporated Delaware corporation formed to be a wholly-owned by PubCo, and was incorporated for the sole purpose of effectuating the Merger (as defined below);

**WHEREAS**, for the sole purpose of effectuating the Share Exchange (as defined below), PubCo will incorporate a Singapore private company limited by shares that is a direct wholly-owned Subsidiary of PubCo (“New SubCo”), and New SubCo will become a party to this Agreement immediately after its incorporation by delivering its signature page to this Agreement pursuant to Section 13.18;

**WHEREAS**, the parties hereto desire and intend to effect a business combination transaction whereby upon the terms and subject to the conditions of this Agreement, (a) Acquiror shall merge with and into Merger Sub, with Acquiror continuing as the surviving entity (the “Merger”), as a result of which, (i) Acquiror shall become a wholly-owned subsidiary of PubCo and (ii) all of the issued and outstanding securities of Acquiror immediately prior to the Merger Effective Time (as defined below) shall no longer be outstanding and shall automatically be cancelled, in exchange for the right of the holders thereof to receive substantially equivalent securities of PubCo, and (b) New SubCo shall acquire all of the issued and outstanding Company Ordinary Shares (as defined below) from the Sellers, and in exchange, PubCo shall issue to the Sellers certain ordinary shares of PubCo (the “Share Exchange”), in each case, upon the terms and subject to the conditions set forth in this Agreement and in accordance with the provisions of the Delaware General Corporation Law, as amended (the “Delaware Act”) and other applicable laws;

---

**WHEREAS**, each of the parties hereto intends that, for U.S. federal income tax purposes, (i) the Merger qualifies as a “reorganization” within the meaning of Section 368 of the Code (as defined below) and the Treasury Regulations (as defined below) thereunder, (ii) the Share Exchange, together with the Merger, qualifies as a transfer of property described in Section 351 of the Code and the Treasury Regulations thereunder, (iii) this Agreement constitutes a “plan of reorganization” within the meaning of Sections 354, 361 and 368 of the Code and the Treasury Regulations thereunder and (iv) PubCo shall not be treated as a domestic corporation under Section 7874 of the Code and the Treasury Regulations promulgated thereunder (the “Intended Tax Treatment”);

**WHEREAS**, the board of directors of Acquiror has (i) determined that it is advisable for Acquiror to enter into this Agreement and the documents contemplated hereby, (ii) approved the execution and delivery of this Agreement and the documents contemplated hereby and the transactions contemplated hereby and thereby, and (iii) recommended the adoption and approval of this Agreement and the other documents contemplated hereby and the transactions contemplated hereby and thereby by the Acquiror Shareholders (as defined below);

**WHEREAS**, the board of directors of PubCo has (i) determined that it is advisable for PubCo to enter into this Agreement and the documents contemplated hereby, (ii) approved the execution and delivery of this Agreement and the documents contemplated hereby and the transactions contemplated hereby and thereby, and (iii) recommended the adoption and approval of this Agreement and the other documents contemplated hereby and the transactions contemplated hereby and thereby by PubCo’s shareholders;

**WHEREAS**, the board of directors of the Company has (i) determined that it is advisable for the Company to enter into this Agreement and the documents contemplated hereby, (ii) approved the execution and delivery of this Agreement and the documents contemplated hereby and the transactions contemplated hereby and thereby, and (iii) recommended the adoption and approval of this Agreement and the other documents contemplated hereby and the transactions contemplated hereby and thereby by the Company Shareholders;

**WHEREAS**, the board of directors of Merger Sub has (i) determined that it is advisable for Merger Sub to enter into this Agreement and the documents contemplated hereby, (ii) approved the execution and delivery of this Agreement and the documents contemplated hereby and the transactions contemplated hereby and thereby, and (iii) PubCo, as the sole shareholder of Merger Sub has adopted a resolution by written consent approving this Agreement and the documents contemplated hereby and the transactions contemplated hereby and thereby;

**WHEREAS**, the board of directors of New SubCo has (i) determined that it is advisable for New SubCo to enter into this Agreement and the documents contemplated hereby, (ii) approved the execution and delivery of this Agreement and the documents contemplated hereby and the transactions contemplated hereby and thereby, and (iii) PubCo, as the sole shareholder of New SubCo has adopted a resolution by written consent approving this Agreement and the documents contemplated hereby and the transactions contemplated hereby and thereby;

**WHEREAS**, each of the Signing Sellers have duly approved the execution and delivery of this Agreement and the documents contemplated hereby and the transactions contemplated hereby and thereby;

**WHEREAS**, in furtherance of the Merger and in accordance with the terms hereof, Acquiror shall provide an opportunity to its shareholders to have their outstanding Acquiror Common Stock (as defined below) redeemed on the terms and subject to the conditions set forth in this Agreement, and Acquiror's Governing Documents (as defined below) in connection with obtaining the Acquiror Shareholder Approval (as defined below);

**WHEREAS**, prior to the Merger Effective Time, certain Sellers and the Sponsors shall have entered into lock-up agreements with the Acquiror and PubCo substantially in the form attached hereto as Exhibit A (collectively, the "Lock-up Agreements");

**WHEREAS**, prior to the Merger Effective Time, the definitive agreements will have been executed and delivered by the investors in connection with the Transaction Financing (as defined below);

**WHEREAS**, prior to the Share Exchange Closing (as defined below), Acquiror, the Sponsors, PubCo and certain other parties thereto shall have entered into a registration rights agreement substantially in the form attached hereto as Exhibit B (the "Registration Rights Agreement"), which shall be effective as of the Share Exchange Closing;

**WHEREAS**, immediately prior to or upon the Merger Effective Time, PubCo, Acquiror and VStock Transfer, LLC have entered into a Warrant Assumption Agreement in the form attached hereto as Exhibit C (the "Warrant Assumption Agreement"); and

**WHEREAS**, prior to Share Exchange Closing, each of the Company and the Acquiror Parties shall negotiate in good faith and agree on the forms of (i) the non-disclosure, non-competition and non-solicitation agreement in favor of the PubCo and the Company (the "Non-Disclosure, Non-Competition and Non-solicitation Agreement"), and (ii) the standard employment agreement form of the PubCo (the "PubCo Employment Agreement").

**NOW, THEREFORE**, in consideration of the foregoing and the respective representations, warranties, covenants and agreements set forth in this Agreement and intending to be legally bound hereby, Acquiror, PubCo, New SubCo, the Company and the Sellers agree as follows:



## ARTICLE I

### CERTAIN DEFINITIONS

Section 1.1. Definitions. As used herein, the following terms shall have the following meanings:

“Acquiror” has the meaning specified in the Preamble hereto.

“Acquiror Acquisition Proposal” means (i) any Business Combination, in one transaction or a series of transactions, involving Acquiror or any of its current or future controlled affiliates or involving all or a material portion of the assets, equity securities or businesses of Acquiror or its current or future controlled affiliates (whether by merger, consolidation, recapitalization, purchase or issuance of equity securities, purchase of assets, tender offer or otherwise); or (ii) any equity or similar investment in or by Acquiror and/or any of its controlled affiliates, in each case, other than the Transactions.

“Acquiror Class A Common Stock” means each share of Class A common stock, par value \$0.0001 per share, of Acquiror.

“Acquiror Class B Common Stock” means each share of Class B common stock, par value \$0.0001 per share, of Acquiror.

“Acquiror Common Stock” means collectively Acquiror Class A Common Stock and Acquiror Class B Common Stock.

“Acquiror Confidential Information” means all confidential or proprietary documents and information concerning Acquiror or any of its Representatives, excluding any information which, (i) at the time of disclosure by the Company, PubCo, New SubCo, Merger Sub, any Seller or any of their respective Representatives, is generally available publicly and was not disclosed in breach of this Agreement or any other Contract between the Company and Acquiror or (ii) at the time of the disclosure by Acquiror or its Representatives to the Company, PubCo, New SubCo, Merger Sub, any Seller or any of their respective Representatives, was previously known by such receiving party without violation of Law or any confidentiality obligation by the Person receiving such Acquiror Confidential Information.

“Acquiror IPO” means the initial public offering of the Acquiror Units pursuant to the Acquiror IPO Prospectus.

“Acquiror IPO Prospectus” the Registration Statement on Form S-1 (File No. 333-262457) relating to the Acquiror that was declared effective by the SEC on May 12, 2022.

“Acquiror Parties” means the Acquiror and the Acquisition Entities.

“Acquiror Preferred Stock” each share of preferred stock, par value \$0.0001 per share, of Acquiror.

“Acquiror Redemption Price” means a per-share price, payable in cash, equal to a pro rata share of the aggregate amount on deposit in the Trust Account (including any interest earned on the funds held in the Trust Account) (as determined in accordance with Acquiror’s Governing Documents) in connection with the Transaction Proposals.

“Acquiror Rights” means each such right that entitles the holder thereof to receive one-eighth (1/8) of one share of Class A common stock of Acquiror at the closing of a Business Combination (as such term is defined in the Acquiror’s Governing Documents).

“Acquiror Securities” means the Equity Securities of Acquiror.

“Acquiror Share Redemption” means the election of an eligible (as determined in accordance with Acquiror’s Governing Documents) holder of Acquiror Common Stock to redeem all or a portion of the Acquiror Common Stock held by such holder at the Acquiror Redemption Price.

“Acquiror Shareholder Approval” means (a) the approval of the Business Combination, this Agreement and the other Transaction Documents, (b) the approval of the Certificate of Merger and the Merger by special resolution (as defined in the Delaware Act) of the Acquiror’s Shareholders at an Acquiror Shareholders’ Meeting duly called by the Acquiror Board held for such purpose and (c) the approval of any other proposals as the SEC (or staff member thereof) indicates (i) are necessary in its comments to the Proxy/Registration Statement or correspondence related thereto and (ii) are required to be approved by the shareholders of Acquiror in order for the Share Exchange Closing to be consummated, in each case with the requisite number of votes required under the Acquiror’s Governing Documents and all applicable Laws.

“Acquiror Shareholders” means the holders of shares of Acquiror Common Stock as of immediately prior to the Merger Effective Time.

“Acquiror Transaction Expenses” means any out-of-pocket fees and expenses actually payable by Acquiror, PubCo, New SubCo, Merger Sub, any of the Sponsors or its Affiliates (whether or not billed or accrued for) as a result of or in connection with Acquiror’s negotiation, documentation and consummation of the Transactions, including (a) all fees (excluding amounts due to the underwriters of Acquiror IPO with respect to deferred underwriting commissions), costs, expenses, brokerage fees, commissions, finders’ fees and disbursements of financial advisors, investment banks, data room administrators, attorneys, accountants and other advisors and service providers, including consultants and public relations firms, and (b) any and all filing fees to the Governmental Authorities in connection with the Transactions.

“Acquiror Units” means the units of Acquiror issued at Acquiror IPO (including overallotment units acquired by Acquiror underwriter) consisting of one share of Acquiror Class A Common Stock, one-half of Acquiror Warrant, and one Acquiror Right.

“Acquiror Warrants” means one whole redeemable warrant of which one-half (1/2) was included as part of each Acquiror Unit, entitling the holder thereof to purchase one (1) share of Acquiror Class A Common Stock at a purchase price of \$11.50 per share, subject to adjustments as provided for in the Acquiror IPO Prospectus.

“Acquisition Entities” means PubCo, Merger Sub and New SubCo and “Acquisition Entity” means any of them.

“ACRA” means the Singapore Accounting and Corporate Regulatory Authority.

“Action” means any claim, action, suit, audit, examination, assessment, arbitration, mediation or inquiry, or any proceeding or investigation, by or before any Governmental Authority.

“Affiliate” means, with respect to any specified Person, any Person that, directly or indirectly, controls, is controlled by, or is under common control with, such specified Person, whether through one or more intermediaries or otherwise. The term “control” (including the terms “controlling”, “controlled by” and “under common control with”) means the possession, directly or indirectly, of the power to direct or cause the direction of the management and policies of a Person, whether through the ownership of voting securities, by Contract or otherwise.

“Aggregate Merger Consideration” means the sum of all PubCo Equity Securities receivable by Acquiror Shareholders pursuant to Article II.

“Alternative Proposal” means, with respect to the Company and its Subsidiaries, other than the transactions contemplated in connection with the Permitted Activities, Transaction Financing or any transaction relating to backstop financing of the Transactions, (i) any acquisition or purchase by any third party, directly or indirectly, of any shares of any class of outstanding voting or equity securities of the Company or any of its subsidiaries, or any tender offer (including a self-tender) or exchange offer that, if consummated, would result in any third-party beneficially owning any shares of any class of outstanding voting or equity securities of the Company or any of its Subsidiaries, (ii) any merger, acquisition, amalgamation, consolidation, business combination, joint venture or other similar transaction involving the Company or any of its Subsidiaries, the business of which constitutes 15% or more of the net revenues, net income or assets of the Company or any of its subsidiaries, (iii) retaining advisors, selecting underwriters, or otherwise commencing any work in relation to an initial public offering, or resolving to make, or making, any filing or submission for an initial public offering with any stock exchange or regulator or (iv) any liquidation, dissolution, recapitalization, extraordinary dividend or other significant corporate reorganization of the Company or any of its Subsidiaries, the business of which constitutes 15% or more of the net revenues, net income or assets of the Company or any of its Subsidiaries.

“Anti-Bribery Laws” means the anti-bribery and accounting provisions of the Foreign Corrupt Practices Act of 1977, as amended, and all other applicable anti-corruption and bribery Laws (including the U.K. Bribery Act 2010, and any rules or regulations promulgated thereunder or other Laws of other countries implementing the OECD Convention on Combating Bribery of Foreign Officials).

“Anti-Money Laundering Laws” means, the applicable financial recordkeeping and reporting requirements of the Currency and Foreign Transactions Reporting Act of 1970, as amended, the money laundering statutes of all jurisdictions in which the Company or any of its Subsidiaries operates, the rules and regulations thereunder and any related or similar rules, regulations or guidelines, issued, administered or enforced by any relevant Governmental Authority.

“Audited Financial Statements” means the PCAOB Financial Statements delivered pursuant to Section 8.3, and the audited consolidated statement of financial positions and consolidated statements of comprehensive income, changes in equity and cash flows of the Company and its Subsidiaries as of and for the years ended June 30, 2022 and June 30, 2021, together with the auditor’s reports thereon.

“Available Acquiror Cash” means an amount (that is not generated from any borrowing) equal to the sum of (i) the amount of cash available in the Trust Account following the Acquiror Shareholders’ Meeting, after deducting the amount required to satisfy the Acquiror Share Redemption but prior to the payment of any deferred underwriting commissions being held in the Trust Account and the payment of any Company Transaction Expenses or Acquiror Transaction Expenses, plus (ii) the proceeds of Transaction Financing.

“Business Combination” has the meaning set forth in Acquiror’s Governing Documents as in effect on the date hereof.

“Business Day” means a day other than a Saturday, Sunday or other day on which commercial banks in Japan, Singapore, or New York or Governmental Authorities in the Cayman Islands, Delaware or Singapore are authorized or required by Law to close.

“Cayman Companies Act” the Companies Act (as revised) of the Cayman Islands.

“Cayman Registrar” means the Registrar of Companies of the Cayman Islands.

“Code” means the U.S. Internal Revenue Code of 1986, as amended.

“Combination” means the consummation of the Merger Closing and the Share Exchange Closing.

“Company Benefit Plan” means an “employee benefit plan” as defined in Section 3(3) of ERISA or any similar plan subject to laws of a jurisdiction outside of the United States (whether or not subject to ERISA), or any other plan, policy, program, practice, or agreement (including any employment, bonus, incentive or deferred compensation, employee loan, note or pledge agreement, equity or equity-based compensation, severance, retention, supplemental retirement, change in control or similar plan, policy, program, practice or agreement) providing compensation or other benefits to any current or former director, officer, individual consultant, worker or employee, which are maintained, sponsored or contributed to by the Company, or to which the Company or any of the Company’s Subsidiaries is a party or has or may have any liability, and in each case whether or not (i) subject to the Laws of the United States, (ii) in writing or (iii) funded, but excluding in each case any statutory plan, program, practice or arrangement that is required under applicable Law and maintained by any Governmental Authority.

“Company Confidential Information” means all confidential or proprietary documents and information concerning the Company and its Subsidiaries and the Sellers or any of their respective Representatives, furnished in connection with this Agreement or the transactions contemplated hereby, excluding any information which, (i) at the time of disclosure by Acquiror Party or its Representatives, is generally available publicly and was not disclosed in breach of this Agreement or any other Contract between the Company and Acquiror or (ii) at the time of the disclosure by the Company or any Seller or their respective Representatives to Acquiror Party or its Representatives was previously known by such receiving party without violation of Law or any confidentiality obligation by the Person receiving such Company Confidential Information.

“Company Convertible Securities” means any options, warrants or rights to subscribe for or purchase any capital shares of the Company or securities convertible into or exchangeable for, or that otherwise confer on the holder any right to acquire any capital shares of the Company.

“Company Insider” means a holder of Company Ordinary Shares who (i) is a director or executive officer of the Company or (ii) owns in the aggregate at least five percent (5%) of the issued and outstanding share capital of the Company.

“Company Material Adverse Effect” means any event, state of facts, development, circumstance, occurrence or effect (collectively, “Events”) that (i) has had, or would reasonably be expected to have, individually or in the aggregate, a material adverse effect on the business, assets and liabilities, results of operations or financial condition of the Company and its Subsidiaries, taken as a whole or (ii) does or would reasonably be expected to, individually or in the aggregate, prevent or materially adversely affect the ability of the Company to consummate the Transactions; provided, that in no event would any of the following, alone or in combination, be deemed to constitute, or be taken into account in determining whether there has been or will be, an Event under clause (i) of the definition of a “Company Material Adverse Effect”: (a) any change in applicable Laws or FRSs or any interpretation thereof following the date of this Agreement, (b) any change in interest rates or economic, political, business or financial market conditions generally, (c) the taking of any action required to be taken under this Agreement, (d) any natural disaster (including hurricanes, storms, tornados, flooding, earthquakes, volcanic eruptions or similar occurrences), epidemic or pandemic (including any COVID-19 Measures or any change in such COVID-19 Measures or interpretations following the date of this Agreement), acts of nature or change in climate, (e) any acts of terrorism or war, the outbreak or escalation of hostilities, geopolitical conditions, local, national or international political conditions, (f) any failure in and of itself of the Company to meet any projections or forecasts (provided that the exception in this clause (f) shall not prevent or otherwise affect a determination that any Event underlying such failure has resulted in or contributed to a Company Material Adverse Effect except where such Event is otherwise excluded under any of clauses (a) through (e) or clauses (g) through (j) of this definition), (g) any Events generally applicable to the industries or markets in which the Company and its Subsidiaries operate, (h) any action taken by, or at the request of, Acquiror, New SubCo, PubCo or Sponsors, or (i) the announcement of this Agreement and consummation of the Transactions, including any termination of, reduction in or similar adverse impact (but in each case only to the extent attributable to such announcement or consummation) on the Company’s and its Subsidiaries’ relationships, contractual or otherwise, with third parties; provided, further, that in the case of each of clauses (a), (b), (c), (d), (e) and (g), any such Event to the extent such Event disproportionately and adversely affects the business, assets, liabilities, results of operations or condition of the Company and its Subsidiaries, taken as a whole, relative to other similarly situated participants in the industries in which such Persons operate shall not be excluded from and shall be taken into account in the determination of whether there has been, or would reasonably be expected to be, a Company Material Adverse Effect, but only to the extent of the incremental disproportionate effect on the Company and its Subsidiaries, taken as a whole, relative to such similarly situated participants.

“Company Ordinary Shares” means the ordinary shares in the capital of the Company, as defined in the Company’s Governing Documents.

“Company Related Party” means any:

(a) member, shareholder or equity interest holder who, together with its Affiliates, directly or indirectly holds no less than 5% of the total outstanding share capital of the Company or any of its Subsidiaries, or

(b) any director, officer or employee of the Company or any of its Subsidiaries with a title of Director (for the avoidance of doubt such title does not refer to a member of the board of directors) or higher or any immediate family member of the foregoing Persons, in each case of clauses (a) and (b), excluding the Company and any of its Subsidiaries.

“Company Shareholder Approval” means the approval of this Agreement and the transactions contemplated hereby pursuant to the terms and subject to the conditions of the Company’s Governing Documents and applicable Law.

“Company Shareholders” means any holder of any Company Ordinary Shares.

“Company Transaction Expenses” means any out-of-pocket fees and expenses payable by (a) the Company or any of its Subsidiaries or Affiliates (whether or not billed or accrued for) as a result of or in connection with the negotiation, documentation and consummation of the Transactions, including (i) all fees, costs, expenses, brokerage fees, commissions, finders’ fees and disbursements of financial advisors, investment banks, data room administrators, attorneys, accountants and other advisors and service providers, including consultants and public relations firms, (ii) any and all filing fees payable by the Company or any of its Subsidiaries or Affiliates to the Governmental Authorities in connection with the Transactions, and (b) the stamp duty payable by the Sellers in connection with the Share Exchange.

“Contracts” means any legally binding contracts, agreements, subcontracts, leases, and purchase orders.

“Copyleft License” means any license that requires, as a condition of use, modification and/or distribution of software subject to such license, that such software subject to such license, or other software incorporated into, derived from, or used or distributed with such software subject to such license (i) in the case of software, be made available or distributed in a form other than binary (e.g., source code form), (ii) be licensed for the purpose of preparing derivative works, (iii) be licensed under terms that allow the Company’s or any Subsidiary of the Company’s products or portions thereof or interfaces therefor to be reverse engineered, reverse assembled or disassembled (other than by operation of Law) or (iv) be redistributable at no license fee. Copyleft Licenses include the GNU General Public License, the GNU Lesser General Public License, the Mozilla Public License, the Common Development and Distribution License, the Eclipse Public License and all Creative Commons “share alike” licenses.

“COVID-19” means SARS-CoV-2 or COVID-19.

“COVID-19 Measures” means any quarantine, “shelter in place,” “stay at home,” social distancing, closure, sequester, safety or similar Law, direction or guidelines promulgated by any Governmental Authority, including the Singapore Ministry of Health, the Japan Ministry of Health, Labor and Welfare, U.S. Centers for Disease Control and Prevention or the World Health Organization, in each case, arising following the date hereof in connection with or in response to COVID-19 for similarly situated companies.

“Dollars” or “\$” means lawful money of the United States.

“DTC” means Depository Trust Company.

“Environmental Laws” means any and all applicable Laws relating to Hazardous Material, pollution, or the protection or management of the environment or natural resources, or protection of human health (with respect to exposure to Hazardous Material).

“Equity Securities” means, with respect to any Person, any capital stock, equity interests, membership interests, partnership interests or registered capital, joint venture or other ownership interests in such person and any options, warrants or other securities (for the avoidance of doubt, including debt securities) that are directly or indirectly convertible into, or exercisable or exchangeable for, such capital stock, equity interests, membership interests, partnership interests or registered capital, joint venture or other ownership interests (whether or not such derivative securities are issued by such Person).

“ERISA” means the Employee Retirement Income Security Act of 1974.

“Exchange Act” means the Securities Exchange Act of 1934, as amended.

“FRSs” means the Financial Reporting Standards in Singapore, as in effect from time to time.

“GAAP” means generally accepted accounting principles in the United States as in effect from time to time.

“Governing Documents” means the legal document(s) by which any Person (other than an individual) establishes its legal existence, or which govern its internal affairs, including the articles of incorporation, certificate of incorporation, memorandum of association, articles of association, bylaws, articles of organization, certificate of formation, limited liability company agreement, operating agreement, or similar or other constitutive, governing, or charter documents, or equivalent documents, of such Person.

“Government Official” means any officer, cadre, civil servant, employee or any other person acting in an official capacity for any Governmental Authority (including any political party or official thereof), any candidate for political office, or any employee of a government owned or controlled entity.

“Governmental Authority” means any federal, state, provincial, municipal, local or foreign government, governmental authority, taxing, regulatory or administrative agency, governmental commission, department, board, bureau, agency or instrumentality, court or tribunal.

“Governmental Authorization” means any consent, waiver, approval or authorization of, or designation, declaration or filing with, or notification to, any Governmental Authority.

“Governmental Order” means any order, judgment, injunction, decree, writ, stipulation, determination or award, in each case, entered by or with any Governmental Authority.



“Group Company” means the Company and its Subsidiaries listed on Section 5.2 of the Company Disclosure Letter

“Hazardous Material” means any (i) pollutant, contaminant, chemical, (ii) industrial, solid, liquid or gaseous toxic or hazardous substance, material or waste, (iii) petroleum or any fraction or product thereof, (iv) asbestos or asbestos-containing material, (v) polychlorinated biphenyl, (vi) chlorofluorocarbons, or (vii) other substance, material or waste, in each case, which are regulated under any Environmental Law or as to which liability may be imposed pursuant to Environmental Law.

“Indebtedness” means with respect to any Person, without duplication, any obligations, contingent or otherwise, in respect of (a) the principal of and premium (if any) in respect of all indebtedness for borrowed money, including accrued interest and any per diem interest accruals, (b) the principal and interest components of capitalized lease obligations under FRSs (with respect to the Company) or GAAP (with respect to Acquiror), (c) amounts drawn (including any accrued and unpaid interest) on letters of credit, bank guarantees, bankers’ acceptances and other similar instruments (solely to the extent such amounts have actually been drawn), (d) the principal of and premium (if any) in respect of obligations evidenced by bonds, debentures, notes and similar instruments, (e) the termination value of interest rate protection agreements and currency obligation swaps, hedges or similar arrangements (without duplication of other indebtedness supported or guaranteed thereby), (f) the principal component of all obligations to pay the deferred and unpaid purchase price of property and equipment which have been delivered, including “earn outs” and “seller notes” and (g) breakage costs, upfront payments or early termination premiums, penalties, or other fees or expenses payable as a result of the consummation of the transactions contemplated hereby in respect of any of the items in the foregoing clauses (a) through (f), and (h) all Indebtedness of another Person referred to in clauses (a) through (g) above guaranteed directly or indirectly, jointly or severally.

“Intellectual Property” means any rights in or to intellectual property of any type or nature, throughout the world, including all: (i) patents, patent applications, invention disclosures, and all related continuations, continuations-in-part, divisionals, reissues, re-examinations, substitutions, and extensions thereof; (ii) registered and unregistered trademarks, logos, service marks, trade dress and trade names, slogans, pending applications therefor, and internet domain names and social media handles, together with the goodwill of the Company or any of its Subsidiaries or their respective businesses symbolized by or associated with any of the foregoing; (iii) registered and unregistered copyrights, and applications for registration of copyright, including such corresponding rights in software and other works of authorship; and (iv) trade secrets, know-how, processes, and other confidential information or proprietary rights.

“International Trade Laws” means all export, import, customs, anti-boycott, and other trade Laws or programs administered, enacted or enforced by any relevant Governmental Authority, including but not limited to: (a) the U.S. Export Administration Regulations, the U.S. International Traffic in Arms Regulations, and the import Laws and regulations administered by U.S. Customs and Border Protection; (b) the anti-boycott Laws administered by the U.S. Departments of Commerce and Treasury; and (c) any other similar export, import, customs, anti-boycott, or other trade Laws or programs in any relevant jurisdiction to the extent they are applicable to the Company or any of its Subsidiaries.

“Investment Company Act” means the Investment Company Act of 1940, as amended.

“Key Person Agreements” means the Contracts described in Section 10.11.

“JOBS Act” means the Jumpstart Our Business Startups Act of 2012, as amended.

“Law” means any statute, law, ordinance, rule, regulation or Governmental Order, in each case, of any Governmental Authority.

“Leased Real Property” means all real property leased, licensed, subleased or otherwise used or occupied by the Company or any of its Subsidiaries.

“Licenses” means any approvals, authorizations, consents, licenses, registrations, permits or certificates of a Governmental Authority.

“Lien” means all liens, mortgages, deeds of trust, pledges, hypothecations, encumbrances, security interests, adverse claim, options, rights of pre-emption, leases, subleases, licenses, restrictions, claims or other liens of any kind whether consensual, statutory or otherwise.

“Long Stop Date” means May 16, 2023, or such a later date which Acquiror is permitted to consummate a Business Combination (as defined in Acquiror’s Governing Documents) in accordance with its Governing Documents.

“Open Source License” means any license meeting the Open Source Definition (as promulgated by the Open Source Initiative) or the Free Software Definition (as promulgated by the Free Software Foundation), or any substantially similar license, including any license approved by the Open Source Initiative or any Creative Commons License. “Open Source Licenses” shall include Copyleft Licenses.

“Open Source Materials” means any software subject to an Open Source License.

“PCAOB” means the U.S. Public Company Accounting Oversight Board.

“Permitted Activities” means any minority investment in or secondary share transfers involving less than 2.5% of the voting power and economic interest of the Company.

“Permitted Activities Documents” means all transaction documents in connection with the Permitted Activities.

“Permitted Liens” means (i) mechanic’s, materialmen’s and similar Liens arising in the ordinary course of business with respect to any amounts (A) not yet due and payable or which are being contested in good faith through appropriate proceedings and (B) for which adequate accruals or reserves have been established in accordance with FRSs, (ii) Liens for Taxes (A) not yet due and payable or (B) which are being contested in good faith through appropriate proceedings and for which adequate accruals or reserves have been established in accordance with FRSs (with respect to the Company) or GAAP (with respect to Acquiror), (iii) defects or imperfections of title, easements, encroachments, covenants, rights-of-way, conditions, matters that would be apparent from a physical inspection or current, accurate survey of such real property, restrictions and other similar charges or encumbrances that do not, in the aggregate, materially impair the value or materially interfere with the use of the Leased Real Property, (iv) with respect to any Leased Real Property (A) the interests and rights of the respective lessors with respect thereto, including any statutory landlord liens and any Lien thereon, (B) any Lien permitted under a Real Property Lease, and (C) any Liens encumbering the underlying fee title of the real property of which the Leased Real Property is a part, (v) zoning, building, entitlement and other land use and environmental regulations promulgated by any Governmental Authority that do not, in the aggregate, materially interfere with the current use of, or materially impair the value of, the Leased Real Property, (vi) non-exclusive licenses of Intellectual Property entered into in the ordinary course of business consistent with past practice, (vii) ordinary course purchase money Liens and Liens securing rental payments under operating or capital lease arrangements for amounts not yet due or payable, (viii) other Liens arising in the ordinary course of business consistent with past practice with respect to the borrowing of money in connection with workers’ compensation, unemployment insurance or other types of social security, (ix) reversionary rights in favor of landlords under any Leased Real Property with respect to any of the buildings or other improvements owned by the Company or any of its Subsidiaries, and (x) other Liens incurred in the ordinary course of business consistent with past practice that do not, individually or in the aggregate, materially and adversely affect the use of the property affected by such Lien, or materially disrupt, the ordinary course operation of the businesses of the Company and its Subsidiaries, taken as a whole.

“Person” means any individual, firm, corporation, partnership, limited liability company, incorporated or unincorporated association, joint venture, joint stock company, Governmental Authority or instrumentality or other entity of any kind.

“Pro Rata Portion” with respect to any Seller at any determination date, means the number of Company Ordinary Shares held by such Seller divided by the total number of Company Ordinary Shares held by all Sellers.

“Purchased Shares” means, as of any reference date, all of the issued and outstanding ordinary shares of the Company, which means 325,332 ordinary shares of the Company as of the date hereof.

“PubCo Ordinary Shares” means the ordinary shares of US\$0.0001 par value each of PubCo.

“PubCo Per Share Price” means the price per PubCo Ordinary Share that equals to the redemption price of each share of Class A Common Stock of Acquiror in connection with the Business Combination, which shall be no less than the par value of PubCo Ordinary Shares.

“PubCo Securities” means the Equity Securities in the capital of PubCo.

“PubCo Warrant” means entitling the holder thereof to purchase one (1) PubCo Ordinary Share at a purchase price of \$11.50 per share.

“Representatives” of a Person means, collectively, officers, directors, employees, accountants, consultants, legal counsel, advisors, agents and other representatives of such Person or its Affiliates.

“Restricted Person” means any Person identified on the U.S. Department of Commerce’s Denied Persons List, Unverified List or Entity List or the U.S. Department of State’s Debarred List.

“Sanctioned Jurisdiction” means any country or territory subject to comprehensive Sanctions (at the time of this Agreement, are the so-called Donetsk People’s Republic, the so-called Luhansk People’s Republic, Cuba, Iran, North Korea, Syria and the Crimea region of Ukraine and Sevastopol).

“Sanctioned Person” means any Person that is (a) organized under the Laws of, or resident or located in, any Sanctioned Jurisdiction, (b) included on any list of Persons subject to Sanctions (including, but not limited to, the U.S. Department of Treasury’s Specially Designated Nationals and Blocked Persons List and the Sectoral Sanctions Identification List; or any similar list maintained or administered by the United Nations Security Council, HM Treasury of the United Kingdom, the European Union, any European Union member state, or any other Governmental Authority where the Company or any of its Subsidiaries operates), or (c) owned fifty percent (50%) or more, directly or indirectly, controlled by, or acting on behalf or at the direction of any Person or Persons described in clauses (a) or (b).

“Sanctions” means those trade, economic and financial sanctions Laws, embargoes, and restrictive measures administered, enacted or enforced from time to time by (a) the United States (including through the Department of the Treasury’s Office of Foreign Assets Control or the Department of State), (b) the European Union or any European Union member state, (c) the United Nations Security Council, (d) Her Majesty’s Treasury of the United Kingdom, or (e) any other Governmental Authority where the Company or any of its Subsidiaries operates.

“Sarbanes-Oxley Act” means the Sarbanes-Oxley Act of 2002.

“SEC” means the United States Securities and Exchange Commission.

“Securities Act” means the Securities Act of 1933, as amended.

“Sponsors” means collectively Prime Number Acquisition LLC and Glorious Capital LLC, and “Sponsor” means either of them.

“Subsidiary” means, with respect to a Person, a corporation or other entity of which more than fifty percent (50%) of the voting power of the Equity Securities or equity interests is owned, directly or indirectly, by such Person and, in case of a limited partnership, limited liability company or similar entity, such Person is a general partner or managing member or has the power to direct the policies, management and affairs of such entity, and a subsidiary is a “wholly-owned Subsidiary” of such Person when substantially all of the voting power of its Equity Securities or equity interests is owned or controlled by such Person.

“Target Valuation” means \$1,350,000,000.

“Tax Return” means any return, declaration, report, statement, information statement or other document filed or required to be filed with any Governmental Authority with respect to Taxes, including any claims for refunds of Taxes, any information returns and any schedules, attachments, amendments or supplements of any of the foregoing.

“Taxes” means any and all federal, state, local, foreign or other taxes imposed by any Governmental Authority, including all income, gross receipts, license, payroll, recapture, net worth, employment, escheat and unclaimed property obligations, excise, severance, stamp, occupation, premium, windfall profits, environmental, customs duties, Equity Securities, ad valorem, value added, inventory, franchise, profits, withholding, social security (or similar), unemployment, disability, real property, personal property, sales, use, transfer, registration, governmental charges, duties, levies and other similar charges imposed by a Governmental Authority in the nature of a tax, alternative or add-on minimum, or estimated taxes, and including any interest, penalty, or addition relating thereto.

“Transaction Documents” means, collectively, this Agreement, the Certificate of Merger, the Post-Combination PubCo Charter, the New SubCo Charter, the Lock-up Agreements, the Subscription Agreements, the Registration Rights Agreement, the Warrant Assignment, Assumption and Amendment Agreement, the Key Person Agreements and any other agreements, documents or certificates entered into or delivered pursuant hereto or thereto, and the expression “Transaction Document” means any one of them.

“Transaction Financing Agreements” means such Contracts between Acquiror and PubCo with investors, in a form and with terms acceptable to Acquiror and the Company, pursuant to which the investors thereunder commit to acquiring PubCo Securities or Equity Securities of Acquiror to be converted into PubCo Securities prior to or upon the Share Exchange, with the form of such Equity Securities to be agreed by the Company and Acquiror.

“Transactions” means, collectively, the Merger, the Share Exchange and each of the other transactions contemplated by this Agreement or any of the other Transaction Documents.

“Treasury Regulations” means the regulations promulgated under the Code by the United States Department of the Treasury (whether in final, proposed or temporary form), as the same may be amended from time to time.

“Warrant Agreement” means the Warrant Agreement, dated as of May 12, 2022 between Acquiror and VStock Transfer, LLC, as warrant agent.

“Working Capital Loans” means any loan made to Acquiror by any of the Sponsors, an Affiliate of the Sponsors, or any of Acquiror’s officers or directors, and evidenced by a promissory note, loan agreement or similar document, for the purpose of financing costs, expenses, extension related costs and deposits and other obligations incurred by Acquiror for the Transactions.

Section 1.2. Other Definitions

Acquiror	Preamble
Acquiror Board	Section 10.2(b)(iii)
Acquiror Board Recommendation	Section 10.2(b)(iii)
Acquiror Cure Period	Section 12.1(e)
Acquiror Disclosure Letter	Article VI
Acquiror Financial Statements	Section 6.6(c)
Acquiror Indemnified Parties	Section 10.13(a)
Acquiror SEC Filings	Section 6.5
Acquiror Shareholders’ Meeting	Section 10.2(b)(i)
Acquiror Transaction Expense Statement	Section 3.5
Allocation Schedule	Section 3.2
Aggregate Exchange Consideration Agreement	Section 3.2
Antitrust Laws	Preamble
Audited Financial Statements	Section 10.14
BCA Joinder	Section 5.9(a)
Certificate of Merger	Section 10.10
Closing Filing	Section 2.3(b)
Closing Press Release	Section 10.4(b)
Company	Section 10.4(b)
Company Board	Preamble
Company Board Recommendation	Section 10.2(c)(ii)
Company Cure Period	Section 10.2(c)(ii)
Company Disclosure Letter	Section 12.1(d)
Company Indemnified Parties	Article V
Company Registered Intellectual Property	Section 10.13(a)
	Section 5.21(a)

Company Shareholders' Meeting	Section 10.2(c)(i)
Company Shareholders' Written Resolution	Section 10.2(c)(i)
Company Share Certificates	Section 3.3(c)
Company Transaction Expense Statement	Section 3.5
Delaware Act	Recitals
D&O Indemnified Parties	Section 10.13(a)
Exchange Consideration	Section 3.2
Intended Tax Treatment	Recitals
Interim Financial Statements	Section 5.9(a)
Interim Financial Statements Date	Section 5.9(a)
Interim Period	Section 8.1
IPO	Section 13.1
Joining Sellers	Preamble
Legal Proceedings	Section 5.11
Lock-up Agreements	Recitals
Material Contracts	Section 5.13(a)
Material In-Licenses	Section 5.13(a)(x)
Merger	Recitals
Merger Closing	Section 2.3(a)
Merger Closing Date	Section 2.3(a)
Merger Effective Time	Section 2.3(b)
Merger Sub	Preamble
Nasdaq	Section 6.17
New SubCo	Recitals
New SubCo Charter	Section 3.4(a)
Non-Disclosure, Non-Competition and Non-Solicitation Agreement	Recitals
Non-Recourse Parties	Section 13.16(b)
PCAOB Financial Statements	Section 8.3(a)
Proxy/Registration Statement	Section 10.2(a)(i)
Post-Combination PubCo Charter	Section 9.9
PubCo	Recital
PubCo ESOP	Section 9.8
PubCo Employment Agreement	Recitals
Public Shareholders	Section 13.1
Real Property Leases	Section 5.20(b)
Registration Rights Agreement	Recitals
Regulatory Approvals	Section 10.1(a)
Related Party Agreements	Section 5.13(a)(vi)
Released Claims	Section 13.1
restraint	Section 11.1(e)
Sellers	Preamble
Share Exchange	Recitals

Share Exchange Closing	Section 3.3(a)
Share Exchange Closing Date	Section 3.3(a)
share exchange restraint	Section 11.3(d)
Signing Filing	Section 10.4(b)
Signing Press Release	Section 10.4(b)
Signing Sellers	Preamble
Singapore Companies Act	Section 3.4(a)
Surviving Corporation	Section 2.1
Terminating Acquiror Breach	Section 12.1(e)
Terminating Company Breach	Section 12.1(d)
Top Vendors	Section 5.28(a)
Transaction Financing	Section 9.12
Transaction Proposals	Section 10.2(a)(i)
Transaction Expense Statements	Section 3.5
Transfer Taxes	Section 10.6
Trust Account	Section 13.1
Trust Agreement	Section 6.8
Trustee	Section 6.8
Warrant Assignment, Assumption and Amendment Agreement	Recitals

Section 1.3. Construction.

(a) Unless the context of this Agreement otherwise requires, (i) words of any gender include each other gender; (ii) words using the singular or plural number also include the plural or singular number, respectively; (iii) the terms “hereof,” “herein,” “hereby,” “hereto” and derivative or similar words refer to this entire Agreement; (iv) the terms “Article” or “Section” refer to the specified Article or Section of this Agreement; (v) the word “including” shall mean “including, without limitation” and (vi) the word “or” shall be disjunctive but not exclusive.

(b) Unless the context of this Agreement otherwise requires, references to statutes shall include all regulations promulgated thereunder and references to statutes or regulations shall be construed as including all statutory and regulatory provisions consolidating, amending or replacing the statute or regulation.

(c) Whenever this Agreement refers to a number of days, such number shall refer to calendar days unless Business Days are specified.

(d) All accounting terms used herein and not expressly defined herein shall have the meanings given to them under GAAP.

Section 1.4. Knowledge. As used herein, the phrase “to the knowledge” of the Company shall mean the actual knowledge of the individuals identified on Section 1.4 of the Company Disclosure Letter, and the knowledge that such individuals would have acquired in the exercise of reasonable inquiries of direct reports; the phrase “to the knowledge” of any Acquiror Party shall mean the actual knowledge of the officers of any Acquiror Party and the knowledge that such individuals would have acquired after reasonable inquiry or investigation.



## ARTICLE II

### **THE MERGER; MERGER CLOSING**

Section 2.1. The Merger. Upon the terms and subject to the conditions set forth in this Agreement and in accordance with the applicable provisions of the Delaware Act, Acquiror and Merger Sub shall consummate the Merger, pursuant to which Merger Sub shall be merged with and into Acquiror, with Acquiror being the surviving entity, following which the separate corporate existence of Merger Sub shall cease and Acquiror shall continue as the surviving corporation in the Merger. Acquiror, as the surviving corporation following the Merger, is hereinafter sometimes referred to as the “Surviving Corporation” (provided, that references to Acquiror for periods after the Merger Effective Time shall include the Surviving Corporation).

Section 2.2. Effects of the Merger. At the Merger Effective Time, the effect of the Merger shall be as provided in this Agreement, the Certificate of Merger and the applicable provisions of the Delaware Act. Without limiting the generality of the foregoing, and subject thereto, at the Merger Effective Time, all the property, rights, privileges, agreements, powers and franchises, debts, Liabilities, immunities, duties and obligations of Merger Sub and Acquiror shall become the property, rights, privileges, agreements, powers and franchises, debts, Liabilities, immunities, duties and obligations of the Surviving Corporation (including all rights and obligations with respect to the Trust Account), which shall include the assumption by the Surviving Corporation of any and all agreements, covenants, duties and obligations of Merger Sub and Acquiror set forth in this Agreement to be performed after the Merger Effective Time, and the Surviving Corporation shall continue its existence as a wholly-owned Subsidiary of PubCo.

Section 2.3. Merger Closing; Merger Effective Time.

(a) In accordance with the terms and subject to the conditions of this Agreement, the closing of the Merger (the “Merger Closing”) shall take place remotely by conference call and exchange of documents and signatures on the date which is no later than five (5) Business Days after the first date on which all conditions set forth in Section 11.1 and Section 11.2 shall have been satisfied or waived (other than those conditions that by their terms are to be satisfied at the Merger Closing, but subject to the satisfaction or waiver thereof) or such other time and place as Acquiror and the Company may mutually agree in writing. The date on which the Merger Closing actually occurs is referred to in this Agreement as the “Merger Closing Date”.

(b) Subject to the satisfaction or waiver of all of the conditions set forth in Section 11.1 and Section 11.2, Acquiror and Merger Sub shall cause the Merger to be consummated by filing a certificate of merger for the Merger of Acquiror with and into Merger Sub in the form attached hereto as Exhibit D (the “Certificate of Merger”), with Acquiror being the surviving entity in the Merger, with the Secretary of State of the State of Delaware, in accordance with the relevant provisions of the Delaware Act (the time of the Certificate of Merger being accepted by the Secretary of State of the State of Delaware, or such later time as may be specified in the Certificate of Merger, being referred to herein as the “Merger Effective Time”).

Section 2.4. Effect of Merger on Issued Securities of Acquiror, PubCo and Merger Sub At the Merger Effective Time, by virtue of the Merger and without any action on the part of any party or the holders of securities of Acquiror, the Company, PubCo or Merger Sub (other than those as described in this Agreement):

(a) *Acquiror Units.* Each Acquiror Unit outstanding immediately prior to the Merger Effective Time shall be automatically detached and the holder thereof shall be deemed to hold one share of Class A common stock of Acquiror, one-half of Acquiror Public Warrant, and one Acquiror Right in accordance with the terms of the applicable Acquiror Unit, which underlying Acquiror Securities shall be converted in accordance with the applicable terms of this Section 2.4 below.

(b) *Acquiror Common Stock.* Each share of Acquiror Common Stock issued and outstanding immediately prior to the Merger Effective Time (other than those described in Section 2.4(d) below) shall automatically be converted into the right to receive one PubCo Ordinary Share, following which all such shares of Acquiror Common Stock shall cease to be outstanding and shall automatically be canceled and shall cease to exist. Each certificate formerly representing shares of Acquiror Common Stock (other than those described in Section 2.4(d) below) shall thereafter represent only the right to receive the same number of PubCo Ordinary Shares.

(c) *Appraisal and Dissenters' Rights.* To the extent required by Section 262 of the Delaware Act, each certificate formerly representing Acquiror Common Stock owned by holders thereof who have validly elected to dissent from the Merger pursuant to Section 262 of the Delaware Act shall thereafter only represent the right to receive fair value for their Acquiror Common Stock in accordance with the applicable provisions of the Delaware Act, and notwithstanding any provision of this Agreement to the contrary and to the extent available under the Delaware Act, shares of Acquiror Common Stock that are outstanding immediately prior to the Merger Effective Time and that are held by holders thereof who shall have neither voted in favor of the Merger nor consented thereto in writing and who shall have demanded properly in writing appraisal or dissenters' rights for such Acquiror Common Stock in accordance with Section 262 of the Delaware Act, and otherwise complied with all of the provisions of the Delaware Act relevant to the exercise and perfection of appraisal rights, shall not be converted into, and such holders shall have no right to receive, the applicable per share Merger consideration unless and until such holder fails to perfect or withdraws or otherwise loses his, her or its right to appraisal and payment under the Delaware Act. Any holder of Acquiror Common Stock who fails to perfect or who effectively withdraws or otherwise loses his, her or its rights to appraisal of such Acquiror Common Stock under Section 262 of the Delaware Act, shall thereupon be deemed to have been converted into, and to have become exchangeable for, as of the Merger Effective Time, the right to receive the applicable per share Merger consideration, without any interest thereon, upon surrender, if applicable, in the manner provided in this Section 2.4, of the certificate or certificates that formerly evidenced such Acquiror Common Stock.

(d) *Cancellation of Capital Stock Owned by Acquiror.* If there are any shares of capital stock of Acquiror that are owned by Acquiror as treasury shares immediately prior to the Merger Effective Time, such shares shall be canceled and extinguished without any conversion thereof or payment therefor.

(e) *Acquiror Warrants.* Each Acquiror Warrant outstanding immediately prior to the Merger Effective Time shall be automatically converted into the right to receive one PubCo Public Warrant, and all Acquiror Warrants shall thereupon cease to be outstanding and shall automatically be canceled and retired and shall cease to exist. Each of the PubCo Warrants shall have, and be subject to, substantially the same terms and conditions set forth in the Acquiror Warrants, except that they shall represent the right to acquire PubCo Ordinary Shares in lieu of shares of Acquiror Common Stock and shall otherwise be amended in accordance with the provisions of the Warrant Assignment and Assumption Amendment Agreement to (among other things) comply with all applicable Laws. At or prior to the Merger Effective Time, PubCo shall take all corporate action necessary to reserve for future issuance, and shall maintain such reservation for so long as any of the PubCo Warrants remain outstanding, a sufficient number of PubCo Ordinary Shares for delivery upon the exercise of such PubCo Warrants.

(f) *Acquiror Rights.* Each Acquiror Right issued and outstanding immediately prior to the Merger Effective Time, shall be automatically converted into the right to receive one-eighth (1/8) of one PubCo Ordinary Share, following which all Acquiror Rights shall cease to be outstanding and shall automatically be canceled and shall cease to exist. At or prior to the Merger Effective Time, PubCo shall have taken all corporate action necessary for issuance of the PubCo Ordinary Shares to the holder of the Acquiror Rights at the Share Exchange Closing.

(g) *Purchase and Cancellation of Issued Shares of PubCo.* The sole holder or holders of shares of PubCo issued and outstanding immediately prior to the Merger Effective Time shall, immediately after the Merger Effective Time, sell, transfer and convey all such shares to PubCo for an aggregate of \$0.01 and PubCo shall have taken all corporate action necessary to repurchase such shares, which shares shall thereupon be canceled by PubCo.

(h) *Cancellation of Shares of Merger Sub.* All of the shares of Merger Sub Common Stock issued and outstanding immediately prior to the Merger Effective Time shall be automatically converted into an equal number of shares of common stock of the Surviving Corporation, with the same rights, powers and privileges as the shares so converted and shall constitute the only outstanding shares of capital stock of the Surviving Corporation.

(i) *Transfers of Ownership.* If any certificate representing securities of Acquiror is to be issued in a name other than that in which the certificate surrendered in exchange therefor is registered, it will be a condition of the issuance thereof that the certificate so surrendered will be properly endorsed (or accompanied by an appropriate instrument of transfer) and otherwise in proper form for transfer and that the person requesting such exchange will have paid to Acquiror or any agent designated by it any transfer or other Taxes required by reason of the issuance of a certificate for securities of Acquiror in any name other than that of the registered holder of the certificate surrendered, or established to the satisfaction of PubCo or any agent designated by it that such Tax has been paid or is not payable.

(j) *Surrender of Acquiror Certificates.* PubCo Securities issued upon the surrender of Acquiror Securities in accordance with the terms hereof shall be deemed to have been issued in full satisfaction of all rights pertaining to such securities,

(k) *Lost, Stolen or Destroyed Acquiror Certificates.* In the event any certificates shall have been lost, stolen or destroyed, PubCo shall issue in exchange for such lost, stolen or destroyed certificates or securities, as the case may be, upon the making of an affidavit of that fact by the holder thereof, such PubCo Securities, as may be required pursuant to this Section 2.4(d); provided, however, that PubCo may, in its discretion and as a condition precedent to the issuance thereof, require the owner of such lost, stolen or destroyed certificates to agree to indemnify PubCo and the Surviving Corporation with respect to the certificates alleged to have been lost, stolen or destroyed.

Section 2.5. Governing Documents of Surviving Corporation. At the Merger Effective Time, the certificate of incorporation and bylaws of Acquiror, each as in effect immediately prior to the Merger Effective Time, shall be amended and restated to read in their entirety in the form of the certificate of incorporation and bylaws of Merger Sub, in each case as in effect immediately prior to the Merger Effective Time, respectively (except that the name of the corporation shall be changed to “Prime Number Acquisition I Corp.”) and, as so amended and restated, shall be the certificate of incorporation and bylaws of the Surviving Corporation until the same may be thereafter further amended and/or restated in accordance with their terms and the Delaware Act.

Section 2.6. Directors and Officers of the Surviving Corporation. At the Merger Effective Time, the board of directors and executive officers of Acquiror shall resign and the board of directors and the executive officers of Merger Sub immediately prior to the Merger Effective Time shall become the board of directors and executive officers of the Surviving Corporation, each to hold office in accordance with the certificate of incorporation and bylaws of the Surviving Corporation until their respective successors are duly elected or appointed and qualified.

## ARTICLE III

### SHARE EXCHANGE

Section 3.1. Exchange of Company Ordinary Shares. No later than one (1) business day following the Merger Closing, upon the terms and subject to the conditions of this Agreement, New SubCo shall purchase, acquire and accept from the Sellers, and the Sellers shall sell, transfer, and deliver to New SubCo all of the Purchased Shares at the Aggregate Exchange Consideration at the Share Exchange Closing. All outstanding Company Convertible Securities (if any) that have not been converted or exercised prior to the Share Exchange Closing shall be terminated without any consideration, payment or liability therefor by virtue of the Share Exchange and without any further action on the part of the Company or Acquiror Entities.

Section 3.2. Exchange Consideration. Subject to and upon the terms and conditions of this Agreement, at the Share Exchange Closing, the Sellers collectively shall be entitled to receive from PubCo, in the aggregate, such number of PubCo Ordinary Shares (the "Aggregate Exchange Consideration") with an aggregate value equal to the Target Valuation, with each Seller receiving for the Company Ordinary Shares held by such Seller, such number of PubCo Ordinary Shares that is equal to the product of (a) the quotient of (i) the Target Valuation, divided by (ii) the PubCo Per Share Price, multiplied by (b) such Seller's Pro Rata Portion as set out in the Allocation Schedule. No holder of Company Equity Securities will receive any consideration under or in connection with this Agreement unless they are Sellers, either as a Signing Seller or as a Joining Seller, and then only with respect to the issued and outstanding Company Ordinary Shares that they own. Annex I to this Agreement sets forth a preliminary schedule of the allocation of the Aggregate Exchange Consideration based on Pro Rata Portion held by each Seller, provided that at least two (2) Business Days prior to the anticipated Share Exchange Closing, the Company shall deliver to Acquiror Parties an updated schedule of the allocation of the Aggregate Exchange Consideration among the Sellers, calculated in accordance with the PubCo Per Share Price and the Pro Rata Portion of each Seller (such allocation schedule as updated the "Allocation Schedule"). The Allocation Schedule is incorporated herein by reference.

Section 3.3. Share Exchange Closing.

(a) In accordance with the terms and subject to the conditions of this Agreement, the closing of the Share Exchange (the "Share Exchange Closing") shall take place as soon as practicable following the time at which the conditions set forth in Section 11.1, Section 11.3, Section 11.4 and Section 11.5 shall have been satisfied or waived (other than those conditions that by their terms are to be satisfied at the Share Exchange Closing, but subject to the satisfaction or waiver thereof) and simultaneously or immediately after the Merger Closing or such other time and place as Acquiror, PubCo and the Company may mutually agree in writing. The date on which the Share Exchange Closing actually occurs is referred to in this Agreement as the "Share Exchange Closing Date".

(b) At the Share Exchange Closing, PubCo shall issue to each Seller such number of PubCo Ordinary Shares as set forth opposite such Seller's name in the Allocation Schedule in exchange for their Company Ordinary Shares in accordance with the Allocation Schedule. No fraction of a PubCo Ordinary Share will be issued by PubCo by virtue of this Agreement or the transactions contemplated hereby, and each Person who would otherwise be entitled to a fraction of a PubCo Ordinary Share (after aggregating all fractional PubCo Ordinary Shares that would otherwise be received by such Person) shall instead have the number of PubCo Ordinary Shares issued to such Person rounded up in the aggregate to the nearest whole PubCo Ordinary Share.

(c) At the Share Exchange Closing, each Seller will deliver to New SubCo the duly executed share transfer form in respect of its Company Ordinary Shares, and the certificate(s) representing Company Ordinary Shares (the "Company Share Certificates") held by such Seller. In the event that any Company Share Certificate shall have been lost, stolen or destroyed, in lieu of delivery of a Company Share Certificate to New SubCo, such Seller may instead deliver to New SubCo a statutory declaration of lost certificate and indemnity of loss in form and substance reasonably acceptable to Acquiror and the Company.

Section 3.4. New SubCo Governance. As of the Share Exchange Closing:

(a) the amended and restated memorandum and articles of association of New SubCo in the form mutually agreed to by the Company and Acquiror (the "New SubCo Charter") shall have been duly adopted and remain in full force and effect, until thereafter amended as provided therein and under the Singapore Companies Act (the "Singapore Companies Act"), and

(b) the board of directors of New SubCo shall consist of one or more individuals whose qualification are satisfactory to the Company.

Section 3.5. Transaction Expense Statements. Subject to the occurrence of the Share Exchange Closing, at or immediately after the Share Exchange Closing, PubCo shall pay or cause to be paid by wire transfer of immediately available funds (or through payment from cash available in the Trust Account pursuant to Section 9.1), (a) all accrued and unpaid Acquiror Transaction Expenses as set forth on a written statement (the "Acquiror Transaction Expense Statement") to be delivered to the Company by or on behalf of Acquiror not less than two (2) Business Days prior to the Share Exchange Closing Date, and (b) any Company Transaction Expenses specified by the Company on a written statement (the "Company Transaction Expense Statement", and collectively with the Acquiror Transaction Expense Statement, the "Transaction Expense Statements") to be delivered to Acquiror by or on behalf of the Company not less than two (2) Business Days prior to the Share Exchange Closing Date, which shall include, in each case of clauses (a) and (b), the respective amounts and wire transfer instructions for the payment thereof, together with corresponding invoices for the foregoing. Each of the Company and Acquiror shall provide the other party and its Representatives with reasonable access to (i) the supporting documentation used by the Company or Acquiror, as applicable, in the preparation of the applicable Transaction Expense Statement and (ii) the Company's Representatives or Acquiror's Representatives, in each case as reasonably requested by Acquiror or the Company (as applicable) in connection with Acquiror's or the Company's review of the applicable Transaction Expense Statement. Prior to the Share Exchange Closing Date, the Company and Acquiror shall consider in good faith any reasonable comments of Acquiror or the Company to the other party's Transaction Expense Statement. If the Company and Acquiror agree to make any modification to any Transaction Expense Statement, then such Transaction Expense Statement as so agreed by the Company and Acquiror to be modified shall be deemed to be the Transaction Expense Statement for purposes of determining the amounts that PubCo shall pay or cause to be paid at or immediately after the Share Exchange Closing pursuant to this Section 3.5.

## ARTICLE IV

### **REPRESENTATIONS AND WARRANTIES OF THE SELLERS**

Each Seller, severally and not jointly, represents and warrants to Acquiror Parties and the Company as of the date hereof (or with respect to a Joining Seller, as of the date such Person became a Joining Seller) and as of the Share Exchange Closing as follows:

Section 4.1. Organization and Standing. Such Seller, if not an individual natural person, is an entity duly organized, validly existing and in good standing (to the extent that the concept of “good standing” is applicable in the case of any jurisdiction outside the United States) under the Laws of the jurisdiction of its formation and has all requisite entity power and authority to own, lease and operate its properties and to carry on its business as now being conducted. Such Seller, if an individual natural person, is of legal age and sound mind.

Section 4.2. Due Authorization. Such Seller has all requisite power and authority to execute and deliver this Agreement and the other Transaction Documents to which it is a party (subject to the approvals described in Section 4.5) to consummate the transactions contemplated hereby and thereby and to perform all of its obligations hereunder and thereunder. The execution and delivery of this Agreement and the other Transaction Documents to which such Seller is a party and the consummation of the transactions contemplated hereby and thereby have been duly and validly authorized and approved by the board of directors or similar governing body of such Seller, and no other company or corporate proceeding on the part of such Seller is necessary to authorize this Agreement and the other Transaction Documents to which such Seller is a party. This Agreement has been, and on or prior to the Share Exchange Closing, the other Transaction Documents to which such Seller is a party contemplated hereby will be, duly and validly executed and delivered by such Seller and this Agreement constitutes, and on or prior to the Share Exchange Closing, the other Transaction Documents to which such Seller is a party contemplated hereby will constitute, a legal, valid and binding obligation of such Seller, enforceable against such Seller in accordance with its terms, subject to applicable bankruptcy, insolvency, fraudulent conveyance, reorganization, moratorium and similar Laws affecting creditors’ rights generally and subject, as to enforceability, to general principles of equity.

Section 4.3. Ownership. Such Seller owns good, valid and marketable title to the Purchased Shares set forth opposite such Seller's name on the Allocation Schedule, free and clear of any and all Liens (other than those imposed by applicable Laws and the Transaction Documents). There are no proxies, voting rights, shareholders' agreements or other agreements or understandings, to which such Seller is a party or by which such Seller is bound, with respect to the voting or transfer of any of such Seller's Purchased Shares other than those contemplated under the Transaction Documents. Upon delivery of such Seller's Purchased Shares to New SubCo on the Share Exchange Closing Date in accordance with this Agreement, the entire legal and beneficial interest in such Purchased Shares and good, valid and marketable title to such Purchased Shares, free and clear of all Liens (other than those imposed by applicable Laws or the Transaction Documents), will pass to New SubCo.

Section 4.4. No Conflict. Subject to the receipt of the consents, approvals, authorizations and other requirements set forth in Section 4.5, the execution and delivery by such Seller of this Agreement and the Transaction Documents to which such Seller is a party contemplated hereby and the consummation of the transactions contemplated hereby and thereby do not and will not (a) violate or conflict with any provision of, or result in the breach of, or default under the Governing Documents of such Seller (if any), or (b) violate or conflict with any provision of, or result in the breach of, or default under any Law or Governmental Order applicable to such Seller, (c) violate or conflict with any provision of, or result in the breach of, result in the loss of any right or benefit, or cause acceleration, or constitute (with or without due notice or lapse of time or both) a default (or give rise to any right of termination, cancellation or acceleration) under any Contract under which such Seller is a party, except, in the case of clauses (a) through (c), to the extent that the occurrence of the foregoing would not, individually or in the aggregate have, or reasonably be expected to have, a material adverse effect on the ability of such Seller to enter into and perform its obligations under this Agreement.

Section 4.5. Governmental Authorities; Consents. Assuming the truth and completeness of the representations and warranties of the Company and the Acquiror Parties contained in this Agreement, no Governmental Authorization is required on the part of such Seller with respect to such Seller's execution or delivery of this Agreement or the consummation by such Seller of the transactions contemplated hereby, except for any consents, approvals, authorizations, designations, declarations, waivers or filings, the absence of which would not, individually or in the aggregate have, or reasonably be expected to have, a material adverse effect on such Seller to enter into and perform its obligations under this Agreement.

Section 4.6. Litigation. There have been, and are, no claims, suits, actions or proceedings pending or, to the knowledge of such Seller, threatened against such Seller which in any manner seek to restrain, enjoin, prohibit, make illegal, or materially delay the Transactions or the performance by such Seller of its obligations under this Agreement or, when executed, any ancillary agreement to which such Seller is a party.



Section 4.7. No Additional Representations. Except as provided in this Article IV and Section 13.1, no Seller, nor any of their respective directors, commissioners, managers, officers, employees, equityholders, partners, members or Representatives has made, or is making, any representation or warranty whatsoever to Acquiror Parties or their respective Affiliates and no such party shall be liable in respect of the accuracy or completeness of any information provided to Acquiror Parties or its Affiliates or their respective Representatives

## ARTICLE V

### REPRESENTATIONS AND WARRANTIES OF THE COMPANY

Except (a) as set forth in the disclosure letter delivered to Acquiror by the Company on the date of this Agreement (as may be updated pursuant to Section 8.6, the “Company Disclosure Letter”) (each section of the Company Disclosure Letter, subject to Section 13.9, qualifies the correspondingly numbered and lettered representations and warranties in this Article V) and (b) as otherwise explicitly contemplated by this Agreement, the Company represents and warrants to Acquiror as of the date hereof and as of the Share Exchange Closing as follows.

Section 5.1. Company Organization. The Company has been duly formed or organized and is validly existing under the Laws of its jurisdiction of incorporation or organization, and has the requisite company or corporate power, as applicable, and authority to own, lease or operate all of its properties and assets and to conduct its business as it is now being conducted. The Governing Documents of the Company, as amended to the date of this Agreement and as previously made available by or on behalf of the Company to Acquiror, are true, correct and complete. The Company is duly licensed or qualified and in good standing as a foreign or extra-provincial corporation (or other entity, if applicable) in each jurisdiction in which its ownership of property or the character of its activities is such as to require it to be so licensed or qualified or in good standing, as applicable, except where the failure to be so licensed or qualified or in good standing would not be material to the business of the Company and its Subsidiaries, taken as a whole.

Section 5.2. Subsidiaries. A complete list of each Subsidiary of the Company and its jurisdiction of incorporation, formation or organization, outstanding Equity Securities, and holders of Equity Securities (including respective numbers and percentages), as applicable, is set forth on Section 5.2 of the Company Disclosure Letter. The Subsidiaries of the Company have been duly formed or organized and are validly existing under the Laws of their jurisdiction of incorporation or organization and have the requisite power and authority to own, lease or operate all of their respective properties and assets and to conduct their respective businesses as they are now being conducted. True, correct and complete copies of the Governing Documents of the Company’s Subsidiaries, in each case, as amended to the date of this Agreement, have been previously made available to Acquiror by or on behalf of the Company. Each Subsidiary of the Company is duly licensed or qualified and in good standing as a foreign corporation (or other entity, if applicable) in each jurisdiction in which its ownership of property or the character of its activities is such as to require it to be so licensed or qualified or in good standing, as applicable, except where the failure to be so licensed or qualified or in good standing would not be material to the business of the Company.

Section 5.3. Due Authorization.

(a) The Company has all requisite company or corporate power, as applicable, and authority to execute and deliver this Agreement and the other documents to which it is a party contemplated hereby and (subject to the approvals described in Section 5.5) to consummate the transactions contemplated hereby and thereby and to perform all of its obligations hereunder and thereunder. The execution and delivery of this Agreement and the other Transaction Documents to which the Company is a party contemplated hereby and the consummation of the transactions contemplated hereby and thereby have been duly and validly authorized and approved by the board of directors of the Company, and no other company or corporate proceeding on the part of the Company is necessary to authorize this Agreement and the other Transaction Documents to which the Company is a party contemplated hereby. This Agreement has been, and on or prior to the Share Exchange Closing, the other Transaction Documents to which the Company is a party contemplated hereby will be, duly and validly executed and delivered by the Company and this Agreement constitutes, and on or prior to the Share Exchange Closing, the other Transaction Documents to which the Company is a party contemplated hereby will constitute, a legal, valid and binding obligation of the Company, enforceable against the Company in accordance with its terms, subject to applicable bankruptcy, insolvency, fraudulent conveyance, reorganization, moratorium and similar Laws affecting creditors' rights generally and subject, as to enforceability, to general principles of equity.

(b) On or prior to the date of this Agreement, the board of directors of the Company has duly adopted resolutions (i) determining that this Agreement and the other Transaction Documents to which the Company is a party contemplated hereby and the transactions contemplated hereby and thereby are advisable and fair to, and in the best interests of, the Company and its stockholders, as applicable, and (ii) authorizing and approving the execution, delivery and performance by the Company of this Agreement and the other Transaction Documents to which the Company is a party contemplated hereby and the transactions contemplated hereby and thereby. No other corporate action is required on the part of the Company or any of its shareholders to enter into this Agreement or the documents to which the Company is a party contemplated hereby or to approve the Transactions, other than the Company Shareholder Approval.

Section 5.4. No Conflict. Subject to the receipt of the consents, approvals, authorizations and other requirements set forth in Section 5.5, the execution and delivery by the Company of this Agreement and the other Transaction Documents to which the Company is a party contemplated hereby and the consummation of the transactions contemplated hereby and thereby do not and will not (a) violate or conflict with any provision of, or result in the breach of, or default under the Governing Documents of any Group Company, (b) violate or conflict with any provision of, or result in the breach of, or default under any Law or Governmental Order applicable to any Group Company, (c) violate or conflict with any provision of, or result in the breach of, result in the loss of any right or benefit, or cause acceleration, or constitute (with or without due notice or lapse of time or both) a default (or give rise to any right of termination, cancellation, modification or acceleration) under any Material Contract to which any Group Company is a party or by which the Company or any of the Company's Subsidiaries may be bound, or terminate or result in the termination of any such foregoing Contract or (d) result in the creation of any Lien (other than Permitted Liens) upon any of the properties or assets of any Group Company, except, in the case of clauses (b) through (d), to the extent that the occurrence of the foregoing would not, individually or in the aggregate, (i) have, or reasonably be expected to have, a material adverse effect on the ability of any Group Company to enter into and perform their obligations under this Agreement, or (ii) be or reasonably be expected to be material to the business of the Group Companies (taken as a whole).

Section 5.5. Governmental Authorities; Consents. Assuming the truth and completeness of the representations and warranties of the Sellers and the Acquiror Parties contained in this Agreement, no Governmental Authorization is required on the part of any Group Company with respect to the Company's execution or delivery of this Agreement or the consummation by the Company of the transactions contemplated hereby, except for any consents, approvals, authorizations, designations, declarations, waivers or filings, the absence of which would not, individually or in the aggregate, (i) have, or reasonably be expected to have, a material adverse effect on the ability of the Company to enter into and perform its obligations under this Agreement, or (ii) be or reasonably be expected to be material to the business of the Group Companies (taken as a whole).

Section 5.6. Capitalization of the Company.

(a) As of the date of this Agreement, the issued and outstanding share capital of the Company consists of 325,332 Company Ordinary Shares. Set forth in Section 5.6 of the Company Disclosure Letter is a true, correct and complete list of each legal owner of Company Ordinary Shares or other Equity Securities of the Company and the number of Company Ordinary Shares or other Equity Securities held by each such holder as of the date hereof. Except as set forth in Section 5.6 of the Company Disclosure Letter or pursuant to the Permitted Activities Documents, as of the date hereof there are no other ordinary shares, preferred shares or other Equity Securities of the Company authorized, reserved for issuance, issued or outstanding. All of the issued and outstanding Company Shares (x) have been duly authorized and validly issued and allotted and are fully paid; (y) have been offered, sold, transferred and issued in compliance with applicable Law; and (z) are free and clear of any Liens.

(b) The Company has not issued, granted, and is not otherwise bound by or subject to any outstanding subscriptions, options, warrants, rights or other securities (including debt securities) convertible, exercisable or exchangeable for Company Ordinary Shares, any other commitments, calls, conversion rights, rights of exchange or privilege (whether pre-emptive, contractual or by matter of Law), plans or other agreements of any character providing for the issuance of additional shares, the sale of treasury shares or other equity interests, or for the repurchase or redemption of shares or other equity interests of the Company or the value of which is determined by reference to shares or other equity interests of the Company, and there are no voting trusts, proxies or agreements of any kind which may obligate the Company to issue, purchase, register for sale, redeem or otherwise acquire any Company Ordinary Shares.

Section 5.7. Capitalization of Subsidiaries.

(a) The outstanding share capital or other Equity Securities of each of the Company's Subsidiaries (i) have been duly authorized and validly issued and allotted, are, to the extent applicable, fully paid and non-assessable; (ii) have been offered, sold, issued and allotted in compliance with applicable Law, including federal and state securities Laws, and all requirements set forth in (1) the Governing Documents of each such Subsidiary, and (2) any other applicable Contracts governing the issuance or allotment of such securities; and (iii) are not subject to, nor have they been issued in violation of, any purchase option, call option, right of first refusal, preemptive right, subscription right or any similar right under any provision of any applicable Law, the Governing Documents of each such Subsidiary or any Contract to which each such Subsidiary is a party or otherwise bound.

(b) Except as set forth in Section 5.2 and Section 5.7 of the Company Disclosure Letter, the Company owns of record and beneficially all the issued and outstanding Equity Securities of such Subsidiaries free and clear of any Liens.

(c) There are no outstanding subscriptions, options, warrants, rights or other securities (including debt securities) exercisable or exchangeable for any Equity Securities of such Subsidiaries, any other commitments, calls, conversion rights, rights of exchange or privilege (whether pre-emptive, contractual or by matter of Law), plans or other agreements of any character providing for the issuance of additional shares, the sale of treasury shares or other equity interests, or for the repurchase or redemption of shares or other Equity Securities of such Subsidiaries or the value of which is determined by reference to shares or other equity interests of the Subsidiaries, and there are no voting trusts, proxies or agreements of any kind which may obligate any Subsidiary of the Company to issue, purchase, register for sale, redeem or otherwise acquire any of its Equity Securities.

Section 5.8. Statutory Registers. All registers, statutory books, books of account and other corporate records of any Group Company are maintained in accordance with applicable Law on a proper and consistent basis, contain complete and accurate records of all material matters required to be dealt with in such books and records, and have as required by Law attached to them copies of all such resolutions and agreements when filed.

Section 5.9. Financial Statements; Internal Controls.

(a) Attached as Section 5.9(a) of the Company Disclosure Letter are: true, fair and complete copies of the unaudited consolidated balance sheets of the Group Companies, and the related statements of operations and statements of cash flows, as of and for the years ended June 30, 2022 and June 30, 2021 (the "Interim Statements Date(s)") (such financial statements, the "Interim Financial Statements").

(b) The Interim Financial Statements (i) were prepared from the books and records of the Group Companies; (ii) were prepared on an accrual basis in accordance with GAAP; (iii) contain and reflect all necessary adjustments and accruals for a fair presentation of the Company's financial condition on a consolidated basis as of applicable Interim Statements Date including for all warranty, maintenance, services and indemnification obligations; and (iv) contain and reflect adequate provisions for all Liabilities for all material Taxes applicable to the Company with respect to the applicable Interim Statements Date. The Interim Financial Statements truly and fairly reflect in all material respects the outstanding Indebtedness of the Company as of the applicable Interim Statement Date, subject to any adjustment in the Audited Financial Statements. The Audited Financial Statements when delivered (i) shall give a true and fair view of the consolidated financial position of the Company and its consolidated Subsidiaries, as at the respective dates thereof, and the consolidated results of their operations, their consolidated incomes, their consolidated changes in equity and their consolidated cash flows for the respective periods then ended, (ii) shall have been prepared in conformity with GAAP applied on a consistent basis during the periods involved (except as may be indicated in the notes thereto), (iii) shall have been prepared from, and shall have been in accordance in all material respects with, the books and records of the Company and its consolidated Subsidiaries, (iv) shall contain and reflect all necessary adjustments and accruals for a fair presentation of the Company's financial position on a consolidated basis as of their dates including for all warranty, maintenance, service and indemnification obligations, (v) shall contain and reflect adequate provisions for all Liabilities for all material Taxes applicable to the Group Companies with respect to the periods then ended, and (vi) in the case of the PCAOB Financial Statements when delivered by the Company for inclusion in the Proxy/Registration Statement for filing with the SEC following the date of this Agreement in accordance with Section 8.3, will comply in all material respects with the applicable accounting requirements (including the standards of the PCAOB) and with the rules and regulations of the SEC, the Exchange Act and the Securities Act applicable to a registrant, in effect as of the respective dates thereof.

(c) Neither the Company nor any director or officer of the Company nor or any of its Subsidiaries, to the knowledge of the Company, any independent auditor of the Company or its Subsidiaries, has, since July 1, 2020, identified or been made aware of (i) any significant deficiency or material weakness in the system of internal accounting controls utilized by the Company or any of its Subsidiaries, (ii) any fraud, whether or not material, that involves the Company's management or other employees who have a role in the preparation of financial statements or the internal accounting controls utilized by the Company or any of its Subsidiaries or (iii) any claim or allegation regarding any of the foregoing.

(d) Since July 1, 2020, the Company has maintained a system of internal accounting controls which is reasonably sufficient to provide reasonable assurance that (i) transactions are executed in accordance with management's general or specific authorizations, (ii) transactions are recorded as necessary to permit preparation of financial statements in conformity with GAAP and to maintain asset accountability, (iii) access to assets is permitted only in accordance with management's general or specific authorization and (iv) the recorded accountability for assets is compared with the existing assets at reasonable intervals and appropriate action is taken with respect to any differences. The books and records of the Company have been, and are being, maintained in all material respects in accordance with FRSs and any other applicable legal and accounting requirements.

(e) The Company Board would, as of the date hereof and as of the Share Exchange Closing Date be able to give a solvency statement in relation to the Company in accordance with Section 215I and Section 215J of the Singapore Companies Act, to effect the Share Exchange, and the Company is not aware of any fact, matter or circumstance that has occurred or is reasonably expected to occur which would render the Company Board unable to give such solvency statement when required to do so in connection with the Share Exchange.

Section 5.10. Undisclosed Liabilities. Except as set forth on the Interim Financial Statements, there has been no liability, debt (including Indebtedness) or obligation of, or claim or judgment against, any Group Company (whether direct or indirect, absolute or contingent, accrued or unaccrued, known or unknown, liquidated or unliquidated, or due or to become due), except for liabilities, debts, obligations, claims or judgments (a) reflected or reserved for on the Audited Financial Statements or disclosed in the notes thereto, (b) that have arisen since the date of the most recent statement of financial position included in the Audited Financial Statements in the ordinary course of business, consistent with past practice, of any Group Company or (c) that will be discharged or paid off prior to or at the Share Exchange Closing since June 30, 2022.

Section 5.11. Litigation and Proceedings. Except as set forth on Section 5.11 of the Company Disclosure Letter, (a) there are no pending or, to the knowledge of the Company, threatened, lawsuits, actions, suits, judgments, claims, proceedings or any other Actions (including any investigations or inquiries initiated, pending or threatened by any Governmental Authority), or other proceedings at law or in equity (collectively, "Legal Proceedings"), against the Company or any of the Company's Subsidiaries or their respective properties or assets; and (b) since January 1, 2021, neither the Company nor any Company Subsidiary has had any Governmental Order imposed on it; (ii) none of the properties or assets of the Company or any of the Company's Subsidiaries' respective businesses is, or has been since January 1, 2021, bound or subject to any Governmental Order, except, in each case of (i) and (ii), as would not, individually or in the aggregate, be or reasonably be expected to be material to the business of the Company and its Subsidiaries (taken as a whole).

Section 5.12. Legal Compliance.

(a) Except as would not be or reasonably be expected to be material to the business of the Company and its Subsidiaries (taken as a whole), each of the Company and its Subsidiaries is currently, or has been since July 25, 2019, in compliance with all applicable Laws in all material respects.

(b) Since July 25, 2019, none of the Company or any of its Subsidiaries has received any written notice of, or been charged with, the violation of any Laws, except where such violation has not been and would not reasonably be expected to be material to the business of the Company and its Subsidiaries, taken as a whole.

(c) The Company and its Subsidiaries maintain a program of policies, procedures and internal controls reasonably designed and implemented to provide reasonable assurance that violation of applicable Law by any of the Company's or its Subsidiaries' directors, officers, employees or its or their respective Representatives or other Persons, acting on behalf of the Company or any of the Company's Subsidiaries, will be prevented, detected and deterred.

Section 5.13. Contracts; No Defaults.

(a) True, correct and complete copies of the Contracts (A) described in clauses (i) through (xv) below and (B) to which the Company or any of the Company's Subsidiaries is a party or by which they are bound have been delivered to or made available to Acquiror or its Representatives, together with all amendments thereto (collectively, the "Material Contracts"). Section 5.13(a) of the Company Disclosure Letter sets forth the list of such Material Contracts.

(i) Each Contract involving obligations (contingent or otherwise), payments or revenues in excess of \$200,000 in the last twelve (12) months prior to the date of this Agreement or expected obligations (contingent or otherwise), payments or revenues in excess of \$200,000 in the next twelve (12) months after the date of this Agreement;

(ii) Each note, debenture, other evidence of Indebtedness, guarantee, loan, credit or financing agreement or instrument or other Contract for money borrowed by, or other Indebtedness of, the Company or any of the Company's Subsidiaries, including any other agreement or commitment for future loans, credit or financing, in each case, in excess of \$200,000;

(iii) Each Contract for the acquisition of any Person or any business unit thereof or the disposition of any material assets of the Company or any of its Subsidiaries in the last two (2) years, in each case, involving payments in excess of \$200,000 other than Contracts (A) in which the applicable acquisition or disposition has been consummated and there are no material obligations ongoing, or (B) solely between the Company and its Subsidiaries;

(iv) Each lease, rental or occupancy agreement, license, installment and conditional sale agreement, and other Contract that provides for the ownership of, leasing of, title to, use of, or any leasehold or other interest in any real or personal property that involves aggregate payments in excess of \$100,000 in any calendar year;

(v) Each Contract involving the formation, establishment, contribution to, or operation of a (A) partnership, (B) corporation, limited liability company or other entity, or (C) joint venture, alliance or similar entity, or involving a sharing of profits or losses (including joint development and joint marketing Contracts), or any investment in, loan to or acquisition or sale of the securities, Equity Securities or assets of any person involving payments of an amount higher than \$500,000 (excluding, in the case of clauses (A) and (B), any Subsidiary of the Company);

(vi) Contracts between the Company or any of its Subsidiaries, on the one hand, and any Company Related Party, on the other hand (collectively, "Related Party Agreements"), since July 25, 2019, other than (i) Contracts with respect to a Company Related Party's employment or other similar engagement and confidentiality agreements, and (ii) end-user, consumer, client or customer agreements entered into on an arm's length basis, or (iii) other agreements of a similar nature, in each case with the Company or any of its Subsidiaries entered into in the ordinary course of business consistent with past practice;

(vii) Contracts with each current or former executive officer, director or executive level employee of any Group Company since January 1, 2021;

(viii) Contracts that provide for change in control, retention or similar payments or benefits contingent upon, accelerated by or triggered by the consummation of the transactions contemplated hereby;

(ix) Contracts containing covenants of the Company or any of the Company's Subsidiaries (A) prohibiting or limiting the right of the Company or any of the Company's Subsidiaries to engage in or compete with any Person in any line of business in any material respect or (B) prohibiting or restricting the Company's and the Company's Subsidiaries' ability to conduct their business in any geographic area in any material respect;

(x) Each Contract (including license agreements, coexistence agreements, and agreements with covenants not to sue, but not including non-disclosure agreements, contractor services agreements, consulting services agreements, incidental trademark licenses incident to marketing, printing or advertising Contracts) pursuant to which the Company or any of the Company's Subsidiaries (A) grants to a third Person the exclusive right to use Intellectual Property of the Company and its Subsidiaries that is material to the business of the Company and its Subsidiaries, taken as a whole, or (B) is granted by a third Person the right to use Intellectual Property that is material to the business of the Company and its Subsidiaries taken as a whole (other than Contracts granting nonexclusive rights to use commercially available off-the-shelf software and Open Source Licenses) (collectively, the Contracts within the scope of this clause (B), the "Material In-Licenses");



(xi) Each Contract requiring capital expenditures by the Company or any of the Company's Subsidiaries after the date of this Agreement in an amount in excess of \$200,000 in any calendar year;

(xii) Any Contract that grants to any third Person any "most favored nation rights";

(xiii) Contracts granting to any Person (other than the Company or its Subsidiaries) a right of first refusal, first offer or similar preferential right to purchase or acquire equity interests in the Company or any of the Company's Subsidiaries;

(xiv) Contracts in connection with the waiver, compromise, or settlement of any dispute, claim, litigation or arbitration involving an Action, claim or proceeding in an amount higher than \$200,000; and

(xv) Contracts with a Governmental Authority or sole-source supplier of any product or service (other than utilities), in each case involving payments of an amount higher than \$200,000.

(b) Except for any Contract that will terminate upon the expiration of the stated term thereof prior to the Share Exchange Closing Date, all of the Material Contracts are (i) in full force and effect and (ii) represent the legal, valid and binding obligations of the Company or the relevant Subsidiary of the Company thereto and, to the knowledge of the Company, represent the legal, valid and binding obligations of the counterparties thereto. Except, in each case, where the occurrence of such breach or default or failure to perform would not be material to the business of the Company and its Subsidiaries, taken as a whole, (x) the Company and its Subsidiaries have performed in all respects all respective obligations required to be performed by them to date under such Material Contracts and neither the Company, the Company's Subsidiaries, nor, to the knowledge of the Company, any other party thereto is in breach of or default under any such Contract, (y) during the last twelve (12) months, neither the Company nor any of its Subsidiaries has received any written claim or written notice of termination or breach of or default under any such Material Contract, and (z) to the knowledge of the Company, no event has occurred which individually or together with other events, has or would reasonably be expected to result in a breach of or a default under any such Material Contract by the Company or any of its Subsidiaries or, to the knowledge of the Company, any other party thereto (in each case, with or without notice or lapse of time or both).

Section 5.14. Company Benefit Plans.

(a) Section 5.14(a) of the Company Disclosure Letter sets forth a complete list, as of the date hereof, of each material Company Benefit Plan. With respect to each material Company Benefit Plan, the Company has made available to Acquiror or its Representatives, to the extent applicable, true, complete and correct copies of such Company Benefit Plan (or, if not in writing, a written summary of its material terms) and, as applicable, all plan documents, trust agreements, insurance Contracts or other funding vehicles and all amendments or material modifications thereto.

(b) Except as set forth on Section 5.14(b) of the Company Disclosure Letter, each Company Benefit Plan has been established, operated, funded, maintained and administered in compliance with its terms and all applicable Laws, except where failure to comply would not be or reasonably be expected to be material to the Company and its Subsidiaries, taken as a whole.

Section 5.15. Labor Relations; Employees.

(a) Except as set forth on Section 5.15(a) of the Company Disclosure Letter, (i) neither the Company nor any of its Subsidiaries is a party to or bound by any collective bargaining agreement or any similar agreement, (ii) no such agreement is being negotiated by the Company or any of the Company's Subsidiaries, and (iii) no labor union or any other employee representative body has requested or, to the knowledge of the Company, has sought to represent any of the employees of the Company or its Subsidiaries in the past three (3) years. In the past three (3) years, to the knowledge of the Company, there has been no labor organization activity involving any employees of the Company or any of its Subsidiaries and there has been no actual or, to the knowledge of the Company, threatened strike, slowdown, work stoppage, lockout or other labor dispute against or affecting the Company or any Subsidiary of the Company, in each case except as would not be or reasonably be expected to be, individually or in the aggregate, material to the business of the Company and its Subsidiaries, taken as a whole.

(b) Each of the Company and its Subsidiaries are, and have been for the past three (3) years, in compliance with all applicable Laws respecting labor and employment including, but not limited to, all Laws respecting terms and conditions of employment, health and safety, wages and hours, holiday pay and the calculation of holiday pay, working time, employee classification (with respect to both exempt vs. non-exempt status and employee vs. independent contractor and worker status), child labor, immigration, employment discrimination, disability rights or benefits, equal opportunity and equal pay, plant closures and layoffs, affirmative action, workers' compensation, labor relations, employee leave issues, unemployment insurance and contributions required to be made with respect to any statutory plan, program, practice or arrangement that is required under applicable law and maintained by any Governmental Authority, except where the failure to comply would not be or reasonably be expected to be, individually or in the aggregate, material to the business of the Company and its Subsidiaries, taken as a whole.

(c) Except where it would not be or reasonably be expected to be, individually or in the aggregate, material to the business of the Company and its Subsidiaries, in the past three (3) years, the Company and its Subsidiaries have not received written (i) notice of any unfair labor practice charge or material complaint pending or threatened before any applicable Governmental Authority against them, (ii) notice of any complaints, grievances or arbitrations arising out of any collective bargaining agreement or any other material complaints, grievances or arbitration procedures against them, (iii) notice of any material charge or complaint with respect to or relating to them pending before any applicable Governmental Authority responsible for the prevention of unlawful employment practices, (iv) notice of the intent of any Governmental Authority responsible for the enforcement of labor, employment, wages and hours of work, child labor, immigration, or occupational safety and health Laws to conduct an investigation with respect to or relating to them or notice that such investigation is in progress, or (v) notice of any complaint, lawsuit or other proceeding pending or threatened in any forum by or on behalf of any present or former employee of such entities, any applicant for employment or classes of the foregoing alleging breach of any express or implied Contract of employment, any applicable Law governing employment or the termination thereof or other discriminatory, wrongful or tortious conduct in connection with the employment relationship.

(d) To the knowledge of the Company, no present or former employee, worker or independent contractor of the Company or any of the Company's Subsidiaries' is in material violation of (i) any restrictive covenant, nondisclosure obligation or fiduciary duty to the Company or any of the Company's Subsidiaries or (ii) any restrictive covenant or nondisclosure obligation to a former employer or engager of any such individual relating to (A) the right of any such individual to work for or provide services to the Company or any of the Company's Subsidiaries' or (B) the knowledge or use of trade secrets or proprietary information, in each case except as would not be or reasonably be expected to be, individually or in the aggregate, material to the business of the Company and its Subsidiaries, taken as a whole.

(e) Neither the Company nor any of the Company's Subsidiaries is party to a settlement agreement with a current or former officer, employee or independent contractor of the Company or any of the Company's Subsidiaries that involves allegations relating to sexual harassment, sexual misconduct or discrimination by either (i) an officer of the Company or any of the Company's Subsidiaries or (ii) an employee of the Company or any of the Company's Subsidiaries at the level of Director (for the avoidance of doubt, such title does not refer to a member of the board of directors) or above. To the knowledge of the Company, in the last three (3) years, no allegations of sexual harassment, sexual misconduct or discrimination have been made against (i) an officer of the Company or any of the Company's Subsidiaries or (ii) an employee of the Company or any of the Company's Subsidiaries at the level of Director (for the avoidance of doubt, such title does not refer to a member of the board of directors) or above, in each case except as would not be or reasonably be expected to be, individually or in the aggregate, material to the Company and its Subsidiaries, taken as a whole.

Section 5.16. Taxes.

(a) All material Tax Returns required to be filed by or with respect to the Company or any of its Subsidiaries have been timely filed (taking into account any applicable extensions), all such Tax Returns (taking into account all amendments thereto) are true, correct and complete in all material respects, and all material Taxes due and payable (whether or not shown on any Tax Return) have been paid.

(b) The Company and each of its Subsidiaries have withheld from amounts owing to any employee, creditor or other Person all material Taxes required by applicable Law to be withheld, paid over to the proper Governmental Authority in a timely manner all such withheld amounts required to have been so paid over and complied in all material respects with all applicable withholding and related reporting requirements with respect to such Taxes.

(c) There are no Liens for Taxes (other than Permitted Liens) upon the property or assets of the Company or any of its Subsidiaries.

(d) No claim, assessment, deficiency or proposed adjustment for any material amount of Tax has been asserted in writing or assessed by any Governmental Authority against the Company or any of its Subsidiaries that remains unresolved or unpaid.

(e) There is no material Tax audit or other examination of the Company or any of its Subsidiaries presently in progress with respect to any material Taxes, nor has the Company or any of its Subsidiaries been notified in writing of any request or threat for such an audit or other examination, and there are no waivers, extensions or written requests for any waivers or extensions of any statute of limitations currently in effect with respect to any material Taxes of the Company or any of its Subsidiaries.

(f) Neither the Company nor any of its Subsidiaries has made a request for or entered into a closing agreement, private letter ruling, advance tax ruling or similar agreement with any Governmental Authority with respect to Taxes. Neither the Company nor any of its Subsidiaries has made a change of any method of accounting with respect to any Taxes.

(g) Neither the Company nor any of its Subsidiaries is a party to any Tax indemnification or Tax sharing or similar Tax agreement (other than any such agreement solely between the Company and its existing Subsidiaries and customary commercial Contracts (or Contracts entered into in the ordinary course of business) not primarily related to Taxes).

(h) Neither the Company nor any of its Subsidiaries (i) is liable for Taxes of any other Person (other than the Company and its Subsidiaries) under Treasury Regulation Section 1.1502-6 or any similar provision of state, local or foreign Tax Law or as a transferee or successor or by Contract (other than customary commercial Contracts (or Contracts entered into in the ordinary course of business) not primarily related to Taxes) or (ii) has ever been a member of an affiliated, consolidated, combined or unitary group filing for U.S. federal, state or local income Tax purposes, other than a group the common parent of which was or is the Company or any of its Subsidiaries.

(i) Within the past three (3) years, no written claim has been made by any Governmental Authority where the Company or any of its Subsidiaries does not file Tax Returns that it is or may be subject to taxation in that jurisdiction.

(j) Neither the Company nor any of its Subsidiaries has participated in a “listed transaction” within the meaning of Treasury Regulation 1.6011-4(b)(2).

(k) The Company has not been, is not, and immediately prior to the Share Exchange Closing will not be, treated as an “investment company” within the meaning of Section 368(a)(2)(F) of the Code.

(l) Except as contemplated by this Agreement and the Transactions contemplated hereby, neither the Company nor any of its Subsidiaries has taken any action or agreed to take any action, nor to the knowledge of the Company or any of its Subsidiaries are there any facts or circumstances, that could reasonably be expected to prevent the Transactions from qualifying for the Intended Tax Treatment.

Section 5.17. Insurance. Section 5.17 of the Company Disclosure Letter contains a list of, as of the date hereof, all material policies or binders of property, fire and casualty, product liability, workers’ compensation, and other forms of insurance held by, or for the benefit of, the Company as of the date of this Agreement. True, correct and complete copies of such insurance policies as in effect as of the date hereof have previously been made available to Acquiror or its Representatives. All such policies are in full force and effect, all premiums due have been paid, and no written notice of cancellation or termination has been received by the Company or any of the Company’s Subsidiaries with respect to any such policy. Except as disclosed on Section 5.17 of the Company Disclosure Letter, no insurer has denied or disputed coverage of any material claim under an insurance policy during the last two (2) years.

Section 5.18. Licenses. The Company and its Subsidiaries have obtained, and maintain, all of the material Licenses required to permit the Company and its Subsidiaries to acquire, originate, own, operate, use and maintain their assets substantially in the manner in which they are now operated and maintained and to conduct the business of the Company and its Subsidiaries as currently conducted in all material respects. Each material License held by the Company or any of the Company’s Subsidiaries is in full force and effect. Neither the Company nor any of its Subsidiaries (a) is in default or violation (and no event has occurred which, with notice or the lapse of time or both, would constitute a material default or violation) of any term, condition or provision of any material License to which it is a party, (b) is or has been the subject of any pending or threatened Action by a Governmental Authority seeking the revocation, suspension, termination, modification, or impairment of any material License; or (c) has received any notice that any Governmental Authority that has issued any material License intends to cancel, terminate, or not renew any such material License, except to the extent such material License may be amended, replaced, or reissued as a result of and as necessary to reflect the transactions contemplated hereby, or as otherwise disclosed in Section 5.18 of the Company Disclosure Letter. Section 5.18 of the Company Disclosure Letter sets forth a true, correct and complete list of all material Licenses held by the Company or its Subsidiaries.

Section 5.19. Equipment and Other Tangible Property. The Company or one of its Subsidiaries owns and has good title to, and has the legal and beneficial ownership of or a valid leasehold interest in or right to use by license or otherwise, all material machinery, equipment and other material tangible property reflected on the books of the Company and its Subsidiaries as owned by the Company or one of its Subsidiaries, free and clear of all Liens other than Permitted Liens. All material personal property and leased personal property assets of the Company and its Subsidiaries are, to the knowledge of the Company, structurally sound and in good operating condition and repair (ordinary wear and tear expected) and are suitable for their present use.

Section 5.20. Real Property. Section 5.20 of the Company Disclosure Letter sets forth a true, correct and complete list, as of the date of this Agreement, of (w) the street address of each parcel of Leased Real Property, (x) the identity of the lessor, lessee and current occupant (if different from lessee) of each such parcel of Leased Real Property, and (y) the term and rental payment amounts pertaining to each such parcel of Leased Real Property. Neither the Company nor its Subsidiaries owns any real property. Except as would not be or reasonably be expected to be material to the business of the Company and its Subsidiaries, taken as a whole, with respect to each parcel of Leased Real Property:

(a) The Company or one of its Subsidiaries holds a good and valid leasehold estate in such Leased Real Property, free and clear of all Liens, except for Permitted Liens.

(b) The Company and its Subsidiaries have delivered to Acquiror true, correct and complete copies of all leases, lease guaranties, subleases, agreements for the leasing, use or occupancy of, or otherwise granting a right in and to the Leased Real Property by or to the Company or any of its Subsidiaries, including all amendments, terminations and modifications thereof (collectively, the "Real Property Leases"), and none of such Real Property Leases has been modified in any material respect, except to the extent that such modifications have been disclosed by the copies delivered to Acquiror.

(c) The Company's and its Subsidiaries', as applicable, possession and quiet enjoyment of the Leased Real Property under such Real Property Leases has not been materially disturbed and, to the knowledge of the Company, there are no material disputes with respect to such Real Property Leases.

(d) To the knowledge of the Company, no party, other than the Company or its Subsidiaries, has any right to use or occupy the Leased Real Property or any portion thereof.

(e) Neither the Company nor any of its Subsidiaries has received written notice of any condemnation proceeding or proposed similar Action or agreement for taking in lieu of condemnation with respect to any portion of the Leased Real Property. No material defaults by (A) the Company or its Subsidiaries or (B) to the knowledge of the Company, any landlord or sub-landlord, as applicable, presently exists under any Real Property Lease.

Section 5.21. Intellectual Property.

(a) Section 5.21(a) of the Company Disclosure Letter lists each item of material Intellectual Property that is registered or applied-for with a Governmental Authority and is owned by the Company or any of the Company's Subsidiaries as of the date of this Agreement ("Company Registered Intellectual Property"), and material proprietary software owned by the Company or one of the Company's Subsidiaries. The Company or one of the Company's Subsidiaries is the sole and exclusive beneficial and record owner of all of the items of Company Registered Intellectual Property, and, to the knowledge of the Company, all such Company Registered Intellectual Property is subsisting and is valid and enforceable.

(b) Except as would not be expected to be material to the Company and its Subsidiaries, taken as a whole, the Company or one of its Subsidiaries owns, free and clear of all Liens (other than Permitted Liens), or has a valid right to use, all Intellectual Property reasonably necessary or material for the continued conduct of the business of the Company and its Subsidiaries in substantially the same manner as such business has been operated during the twelve (12) months prior to the date hereof.

(c) In respect of any Material In-Licenses granting the Company or any of its Subsidiaries the right to use any Intellectual Property reasonably necessary for the continued conduct of the business of the Company and its Subsidiaries in substantially the same manner as such business has been operated during the twelve (12) months prior to the date hereof (including all amendments, novations, supplements or replacements to such Material In-Licenses), to the knowledge of the Company: (i) such Material In-Licenses are in full force and effect, with no termination notice having been received by the Company or any of its Subsidiaries thereunder; (ii) to the knowledge of the Company, no circumstances exist or have existed which entitle the licensor party to terminate or vary such Material In-Licenses; and (iii) the material obligations of the Company and its Subsidiaries under such Material In-Licenses have been complied with; in each case except as would not be or reasonably be expected to be, individually or in the aggregate, material to the business of the Company and its Subsidiaries, taken as a whole.

(d) The Company and its Subsidiaries have not, within the last three (3) years, infringed upon, misappropriated or otherwise violated and, as of the date of this Agreement, are not infringing upon, misappropriating or otherwise violating any Intellectual Property of any third Person, and there is no action pending to which the Company or any of the Company's Subsidiaries is a named party, or as to which the Company or any of its Subsidiaries has received a threat in writing, alleging the Company's or its Subsidiaries' infringement, misappropriation or other violation of any Intellectual Property of any third Person, in each case except as would not be or reasonably be expected to be, individually or in the aggregate, material to the business of the Company and its Subsidiaries, taken as a whole.

(e) Except as set forth on Section 5.21(e) of the Company Disclosure Letter, to the knowledge of the Company (i) no Person is infringing upon, misappropriating or otherwise violating any material Intellectual Property of the Company or any of the Company's Subsidiaries in any material respect, and (ii) the Company and its Subsidiaries have not sent to any Person within the last three (3) years any written notice, charge, complaint, claim or other written assertion against such third Person claiming infringement or violation by or misappropriation of any Intellectual Property of the Company or any of the Company's Subsidiaries.

(f) The Company and its Subsidiaries have taken commercially reasonable measures to protect the confidentiality of trade secrets and other confidential information included in their Intellectual Property that are material to the business of the Company and its Subsidiaries, taken as a whole. To the knowledge of the Company, there has not been any unauthorized disclosure of or unauthorized access to any material trade secrets or other material confidential information of the Company or any of the Company's Subsidiaries to or by any Person in a manner that has resulted or may result in the misappropriation of, or loss of trade secret or other rights in and to such information.

(g) No government funding, nor any facilities of a university, college, other educational institution or research center, was used in the development of the material Intellectual Property owned by the Company or any of the Company's Subsidiaries and used in connection with the business.

(h) With respect to the software used or held for use in the business of the Company and its Subsidiaries, to the knowledge of the Company, no such software contains any undisclosed or hidden device or feature designed to disrupt, disable, or otherwise impair the functioning of any software or any "back door," "time bomb," "Trojan horse," "worm," "drop dead device," or other malicious code or routines that permit unauthorized access or the unauthorized disablement or erasure of such or other software or information or data (or any parts thereof) of the Company or its Subsidiaries or customers of the Company and its Subsidiaries.

(i) The Company's and its Subsidiaries' use and distribution of (i) software developed by or on behalf of the Company or any Subsidiary, and (ii) Open Source Materials, is, to the knowledge of the Company, in material compliance with all Open Source Licenses applicable thereto. Neither the Company nor any Subsidiary has used any Open Source Materials in a manner that requires any material software or Intellectual Property owned by the Company or any of the Company's Subsidiaries to be subject to Copyleft Licenses.



Section 5.22. Privacy and Cybersecurity.

(a) The Company and its Subsidiaries maintain and are in compliance with, and during the last three (3) years have maintained and been in compliance with, (i) all applicable Laws relating to the privacy and/or security of personal information, (ii) the Company's and its Subsidiaries' posted or publicly facing privacy policies, and (iii) the Company's and its Subsidiaries' contractual obligations concerning cybersecurity, data security and the security of the Company's and each of its Subsidiaries' information technology systems, in each case of (i)-(iii) above, other than any non-compliance that, individually or in the aggregate, has not been or would not reasonably be expected to be material to the Company and its Subsidiaries taken as a whole. There are no material Actions by any Person (including any Governmental Authority) pending to which the Company or any of the Company's Subsidiaries is a named party, or as to which the Company or any of its Subsidiaries has received a threat in writing, alleging a violation of any third Person's privacy or personal information rights.

(b) During the last three (3) years (i) there have been, no material breaches of the security of the information technology systems of the Company and its Subsidiaries, and (ii) there have been no disruptions in any information technology systems that materially adversely affected the Company's and its Subsidiaries' business or operations. The Company and its Subsidiaries take commercially reasonable and legally compliant measures designed to protect confidential, sensitive or personally identifiable information in its possession or control against unauthorized access, use, modification, disclosure or other misuse, including through administrative, technical and physical safeguards. To the knowledge of the Company, neither the Company nor any Subsidiary of the Company has (A) experienced any incident in which such information was stolen or improperly accessed, including in connection with a breach of security, or (B) received any written notice or complaint from any Person with respect to any of the foregoing, nor to the knowledge of the Company has any such notice or complaint been threatened in writing against the Company or any of the Company's Subsidiaries.

Section 5.23. Environmental Matters. The Company and its Subsidiaries are and, except for matters which have been fully resolved, have been in material compliance with all Environmental Laws and neither the Company nor any of its Subsidiaries is subject to any current Governmental Order relating to any material non-compliance with Environmental Laws, in each case except as would not be or reasonably be expected to be, individually or in the aggregate, material to the business of the Company and its Subsidiaries, taken as a whole. There has been no material release of any Hazardous Materials by the Company or its Subsidiaries at, in, on or under any Leased Real Property or in connection with the Company's and its Subsidiaries' operations off-site of the Leased Real Property. No material Legal Proceeding is pending or, to the knowledge of the Company, threatened with respect to the Company's and its Subsidiaries' compliance with or liability under Environmental Laws, and, to the knowledge of the Company, there are no facts or circumstances which could reasonably be expected to form the basis of such a Legal Proceeding.

Section 5.24. Absence of Changes. Since the date of the most recent statement of financial position included in the Interim Financial Statements, (i) there has not been any Company Material Adverse Effect; and (ii) except as set forth in Section 5.24 of the Company Disclosure Letter, the Company has, in all material respects, conducted its business and operated its properties in the ordinary course of business consistent with past practice.

Section 5.25. Anti-Corruption Compliance.

(a) Neither the Company nor its Subsidiaries, nor to the knowledge of the Company, any of their directors or officers, any of the Company or its Subsidiaries' respective, employees, agents, Representatives or other Persons acting for or on behalf of the Company or any of its Subsidiaries has, in the past four (4) years: (i) made any bribe, influence payment, kickback, payoff, benefits or any other type of payment (whether tangible or intangible) that would be unlawful under any applicable anti-bribery or anticorruption (governmental or commercial) laws (including, for the avoidance of doubt, any guiding, detailing or implementing regulations), including Laws that prohibit the corrupt payment, offer, promise or authorization of the payment or transfer of anything of value (including gifts or entertainment), directly or indirectly, to any Government Official or commercial entity to obtain a business advantage such as Anti-Bribery Laws; (ii) been in violation of any Anti-Bribery Law, offered, paid, promised to pay, or authorized any payment or transfer of anything of value, directly or indirectly, to any person for the purpose of (A) influencing any act or decision of any Government Official in his official capacity, (B) inducing a Government Official to do or omit to do any act in relation to his lawful duty, (C) securing any improper advantage, (D) inducing a Government Official to influence or affect any act, decision or omission of any Governmental Authority, or (E) assisting the Company or any of its Subsidiaries, or any agent or any other Person acting for or on behalf of the Company or any of its Subsidiaries, in obtaining or retaining business for or with, or in directing business to, any Person; or (iii) accepted or received any contributions, payments, gifts, or expenditures that would be unlawful under any Anti-Bribery Law.

(b) Each of the Company and its Subsidiaries has instituted and maintains policies and procedures reasonably designed to ensure compliance in all material respects with the Anti-Bribery Laws.

(c) As of the date hereof, to the knowledge of the Company, there are no current or pending internal investigations, or third-party investigations (including by any Governmental Authority), or internal or external audits, that address any material allegations or information concerning possible material violations of the Anti-Bribery Laws related to the Company or any of the Company's Subsidiaries.

Section 5.26. Anti-Money Laundering, Sanctions and International Trade Compliance.

(a) The Company and its Subsidiaries, and to the knowledge of the Company, each of their respective directors, officers, employees, agents, Representatives and other Persons acting on behalf of the Company or any of the Company's Subsidiaries (i) are, and have been for the past four (4) years, in compliance with all applicable Anti-Money Laundering Laws, Sanctions, and International Trade Laws, and (ii) have obtained all required licenses, consents, notices, waivers, approvals, orders, registrations, declarations, or other authorizations from, and have made any material filings with, any applicable Governmental Authority for all activities and transactions, including for the import, export, re-export, deemed export, deemed reexport, or transfer required under the International Trade Laws and Sanctions and the provision of financial services required under Anti-Money Laundering Laws. There are and have for the past four (4) years been no pending or, to the knowledge of the Company, threatened, claims, complaints, charges, investigations, voluntary disclosures or Legal Proceedings against the Company or any of the Company's Subsidiaries related to any Anti-Money Laundering Laws, Sanctions, or International Trade Laws.

(b) Neither the Company, any of its Subsidiaries nor, to the knowledge of the Company, any of their respective directors or officers, any employees, agents, Representatives or other Persons acting on behalf of the Company or any of the Company's Subsidiaries, (i) is, or has during the past four (4) years, been a Sanctioned Person or a Restricted Person, or (ii) has transacted business directly or indirectly with any Sanctioned Person or Restricted Person or with or in any Sanctioned Jurisdiction, in each case in violation of applicable Sanctions or International Trade Laws.

(c) The Company and its Subsidiaries have in place written policies, procedures, controls, and systems designed to ensure compliance with all applicable Anti-Money Laundering Laws, Sanctions and International Trade Laws.

Section 5.27. Proxy/Registration Statement. The information supplied by the Company or its Subsidiaries in writing specifically for inclusion in the Proxy/Registration Statement shall not, at (a) the time the Proxy/Registration Statement is filed in accordance with Rule 424(b) and/or pursuant to Section 14A or declared effective, (b) the time the Proxy/Registration Statement (or any amendment thereof or supplement thereto) is first mailed to (i) the Acquiror Shareholders and (ii) the Company Shareholders, and (c) the time of (i) the Acquiror Shareholders' Meeting and (ii) the Company Shareholders' Meeting, contain any untrue statement of a material fact or omit to state any material fact required to be stated therein or necessary in order to make the statements therein, in light of the circumstances under which they were made, not misleading.

Section 5.28. Vendors.

(a) Section 5.28(a) of the Company Disclosure Letter sets forth, as of the date of this Agreement, the top 5 vendors based on the aggregate Dollar value of the Company's and its Subsidiaries' transaction volume with such counterparty for the fiscal year of the Company ended June 30, 2021 and June 30, 2022 (the "Top Vendors").

(b) None of the Top Vendors has, as of the date of this Agreement, informed in writing any of the Company or any of the Company's Subsidiaries that it will, or, to the knowledge of the Company, has threatened to, terminate, cancel, or materially limit or materially and adversely modify any of its existing business with the Company or any of the Company's Subsidiaries (other than due to the expiration of an existing contractual arrangement), and to the knowledge of the Company, none of the Top Vendors is, as of the date of this Agreement, otherwise involved in or threatening a material dispute against the Company or its Subsidiaries or their respective businesses.

Section 5.29. Government Contracts. The Company is not party to (a) any Contract, including an individual task order, delivery order, purchase order, basic ordering agreement, letter Contract or blanket purchase agreement between the Company or any of its Subsidiaries, on one hand, and any Governmental Authority, on the other hand, or (b) any subcontract or other Contract by which the Company or any of its Subsidiaries has agreed to provide goods or services through a prime contractor directly to a Governmental Authority that is expressly identified in such subcontract or other Contract as the ultimate consumer of such goods or services.

Section 5.30. Sufficiency of Assets. Except as would not be expected to be material to the business of the Company and its Subsidiaries, taken as a whole, the tangible and intangible assets owned, licensed or leased by the Company and its Subsidiaries constitute all of the assets reasonably necessary for the continued conduct of the business of the Company and its Subsidiaries after the Share Exchange Closing in the ordinary course of business as of the date hereof.

Section 5.31. Investment Company. The Company is not an "investment company" or a Person directly or indirectly "controlled" by or acting on behalf of an "investment company", in each case within the meaning of the Investment Company Act.

Section 5.32. Brokers' Fees. No broker, finder or investment banker is entitled to any brokerage fee, finders' fee or other brokerage commission in connection with the transactions contemplated hereby based upon arrangements made by the Company or any of the Company's Subsidiaries' with respect to which the Company or any of the Company's Subsidiaries has any obligation.

Section 5.33. No Additional Representations or Warranties. Except as provided in this Agreement and any Transaction Document to which the Company or any of Affiliates is a party, neither the Company, nor any of its Affiliates, nor any of their respective directors, commissioners, managers, officers, employees, equityholders, partners, members or Representatives has made, or is making, any representation or warranty whatsoever to Acquiror or its Affiliates.

Section 5.34. Investigation. Notwithstanding anything contained in this Agreement, each of the Company, its Subsidiaries and Company Shareholders has made its own investigation of Acquiror and acknowledges that neither Acquiror nor any of its equityholders, partners, members and Representatives, including any of the Sponsor and its Affiliates, is making any representation or warranty whatsoever, express or implied, other than those expressly given by Acquiror in Article VI.

## ARTICLE VI

### **REPRESENTATIONS AND WARRANTIES OF ACQUIROR**

Except as set forth in (a) any Acquiror SEC Filings publicly available on or prior to the date hereof (excluding (i) any disclosures in any risk factors section that do not constitute statements of fact or factual matters, disclosures in any forward-looking statements disclaimer and other disclosures that are generally cautionary, predictive or forward-looking in nature and (ii) any exhibits or other documents appended thereto), and (b) the disclosure letter delivered by Acquiror to the Company (the "Acquiror Disclosure Letter"), Acquiror represents and warrants to the Company and the Sellers as of the date hereof, the Merger Effective Time and the Share Exchange Closing as follows:

Section 6.1. Acquiror Organization. Acquiror has been duly incorporated, organized or formed and is validly existing as a corporation or exempted company in good standing (or equivalent status, to the extent that such concept exists) under the Laws of its jurisdiction of incorporation, organization or formation, and has the requisite company power and authority to own, lease or operate all of its properties and assets and to conduct its business as it is now being conducted. The copies of Acquiror's Governing Documents, as amended to the date of this Agreement, previously delivered by Acquiror to the Company and the Sellers, are true, correct and complete. Acquiror is duly licensed or qualified and in good standing as a foreign corporation or company in all jurisdictions in which its ownership of property or the character of its activities is such as to require it to be so licensed or qualified, except where the failure to be so licensed or qualified would not, individually or in the aggregate, have or reasonably be expected to have, a material adverse effect on Acquiror.

Section 6.2. Due Authorization.

(a) Acquiror has all requisite corporate power and authority to (i) execute and deliver this Agreement, the other Transaction Documents to which Acquiror is a party and the documents contemplated hereby and thereby, and (ii) consummate the transactions contemplated hereby and thereby and perform all obligations to be performed by it hereunder and thereunder. The execution and delivery of this Agreement, the other Transaction Documents to which Acquiror is a party and the documents contemplated hereby and thereby and the consummation of the transactions contemplated hereby and thereby have been (A) duly and validly authorized and approved by the board of directors of Acquiror and (B) determined by the board of directors of Acquiror as advisable to Acquiror and the Acquiror Shareholders and recommended for approval by the Acquiror Shareholders. No other company proceeding on the part of Acquiror is necessary to authorize this Agreement and the documents contemplated hereby (other than the Acquiror Shareholder Approval). This Agreement has been, and at or prior to the Share Exchange Closing, the other documents contemplated hereby will be, duly and validly executed and delivered by any Acquiror Party, and this Agreement constitutes, and at or prior to the Share Exchange Closing, the other Transaction Documents to which Acquiror Party is a party and the other documents contemplated hereby and thereby will constitute, a legal, valid and binding obligation of Acquiror, enforceable against Acquiror in accordance with its terms, subject to applicable bankruptcy, insolvency, fraudulent conveyance, reorganization, moratorium and similar Laws affecting creditors' rights generally and subject, as to enforceability, to general principles of equity.

(b) The votes on the Transaction Proposals as identified in the Proxy/Registration Statement described in Section 10.2(a)(i) by holders of Acquiror Common Stock (which include the Acquiror Shareholder Approval) are the only votes of the holders of any of Acquiror's Securities that are necessary in connection with entry into this Agreement by Acquiror and the consummation of the transactions contemplated hereby, including the Merger Closing and the Share Exchange Closing.

Section 6.3. No Conflict. Subject to the Acquiror Shareholder Approval, the execution and delivery of this Agreement by Acquiror Party, the other Transaction Documents to which Acquiror is a party and the other documents contemplated hereby and thereby and the consummation of the transactions contemplated hereby and thereby do not and will not (a) violate or conflict with any provision of, or result in the breach of or default under the Governing Documents of Acquiror, (b) violate or conflict with any provision of, or result in the breach of, or default under any applicable Law or Governmental Order applicable to Acquiror, (c) violate or conflict with any provision of, or result in the breach of, result in the loss of any right or benefit, or cause acceleration, or constitute (with or without due notice or lapse of time or both) a default (or give rise to any right of termination, cancellation or acceleration) under any Contract to which Acquiror is a party or by which Acquiror may be bound, or terminate or result in the termination of any such Contract or (d) result in the creation of any Lien (other than Permitted Liens) upon any of the properties or assets of Acquiror, except, in the case of clauses (b) through (d), to the extent that the occurrence of the foregoing does not or would not, individually or in the aggregate, prevent or materially adversely affect the ability of Acquiror to consummate the Transactions.

Section 6.4. Litigation and Proceedings. As of the date hereof (a) there are no pending or, to the knowledge of Acquiror, threatened Legal Proceedings against Acquiror or its properties or assets; and (b) there is no outstanding Governmental Order imposed upon Acquiror, nor are any properties or assets of Acquiror or its business bound or subject to any Governmental Order, except, in each case, as would not, individually or in the aggregate, be or reasonably be expected to be material to the business of Acquiror.

Section 6.5. SEC Filings. Acquiror has timely filed or furnished all statements, prospectuses, registration statements, forms, reports and documents required to be filed by it with the SEC since May 12, 2022, pursuant to the Exchange Act or the Securities Act (collectively, as they have been amended since the time of their filing through the date hereof, the "Acquiror SEC Filings"). Each of the Acquiror SEC Filings, as of the respective date of its filing (or if amended or superseded by a filing prior to the date of this Agreement or the Share Exchange Closing Date, then on the date of such filing), complied in all material respects with the applicable requirements of the Securities Act, the Exchange Act, the Sarbanes-Oxley Act and any rules and regulations promulgated thereunder applicable to the Acquiror SEC Filings. As of the respective date of its filing (or if amended or superseded by a filing prior to the date of this Agreement or the Share Exchange Closing Date, then on the date of such filing), the Acquiror SEC Filings did not contain any untrue statement of a material fact or omit to state a material fact required to be stated therein or necessary to make the statements made therein, in light of the circumstances under which they were made, not misleading. As of the date hereof, there are no outstanding or unresolved comments in comment letters received from the SEC with respect to the Acquiror SEC Filings. None of the Acquiror SEC Filings filed on or prior to the date hereof is subject to ongoing SEC review or, to the knowledge of Acquiror, investigation as of the date hereof. There has been no amendment to the letter agreement entered into by and among Acquiror and Prime Number Capital LLC as the underwriter relating to Acquiror IPO dated May 12, 2022 and such letter agreement is (i) in full force and effect and (ii) represents the legal, valid and binding obligations of Acquiror and, to the knowledge of Acquiror, represents the legal, valid and binding obligations of the other parties thereto.

Section 6.6. Internal Controls; Listing; Financial Statements.

(a) Except as not required in reliance on exemptions from various reporting requirements by virtue of Acquiror's status as an "emerging growth company" within the meaning of the Securities Act, as modified by the JOBS Act or as otherwise set forth in the Acquiror SEC Filings, Acquiror has established and maintains disclosure controls and procedures (as defined in Rule 13a-15 under the Exchange Act). Such disclosure controls and procedures are designed to (i) ensure that material information relating to Acquiror, including its consolidated Subsidiaries, if any, is made known to Acquiror's principal executive officer and its principal financial officer by others within those entities, particularly during the periods in which the periodic reports required under the Exchange Act are being prepared; and (ii) be effective in timely alerting Acquiror's principal executive officer and principal financial officer to material information required to be included in Acquiror's periodic reports required under the Exchange Act. Acquiror has established and maintained a system of internal controls over financial reporting (as defined in Rule 13a-15 under the Exchange Act) which is reasonably sufficient to provide reasonable assurance regarding the reliability of Acquiror's financial reporting and the preparation of Acquiror Financial Statements for external purposes in accordance with GAAP.

(b) To the knowledge of Acquiror, except as set forth in Section 6.6(b) of the Acquiror Disclosure Letter, each director and executive officer of Acquiror has filed with the SEC on a timely basis all statements required by Section 16(a) of the Exchange Act and the rules and regulations promulgated thereunder.

(c) The Acquiror SEC Filings contain true and complete copies of the audited balance sheet as of May 17, 2022, and statement of operations, cash flow and shareholders' equity of Acquiror for the period from February 25, 2021 (inception) through May 17, 2022, together with the auditor's reports thereon (the "Acquiror Financial Statements"). Except as disclosed in the Acquiror SEC Filings, the Acquiror Financial Statements (i) fairly present in all material respects the financial position of Acquiror, as at the respective dates thereof, and the results of operations and consolidated cash flows for the respective periods then ended, (ii) were prepared in conformity with GAAP applied on a consistent basis during the periods involved (except as may be indicated therein or in the notes thereto), and (iii) comply in all material respects with the applicable accounting requirements and with the rules and regulations of the SEC, the Exchange Act and the Securities Act in effect as of the respective dates thereof. The books and records of Acquiror have been, and are being, maintained in all material respects in accordance with GAAP and any other applicable legal and accounting requirements.

(d) There are no outstanding loans or other extensions of credit made by Acquiror to any executive officer (as defined in Rule 3b-7 under the Exchange Act) or director of Acquiror. Acquiror has not taken any action prohibited by Section 402 of the Sarbanes-Oxley Act.

(e) Neither Acquiror nor any director or officer of Acquiror nor, to the knowledge of Acquiror, any employee of Acquiror or Acquiror's independent auditors has identified or been made aware of (i) any significant deficiency or material weakness in the system of internal accounting controls utilized by Acquiror, (ii) any fraud, whether or not material, that involves Acquiror's management or other employees who have a role in the preparation of financial statements or the internal accounting controls utilized by Acquiror or (iii) any claim or allegation regarding any of the foregoing.

Section 6.7. Governmental Authorities; Consents Assuming the truth and completeness of the representations and warranties of the Sellers, the Company and the Acquisition Entities contained in this Agreement, no consent, waiver, approval or authorization of, or designation, declaration or filing with, or notification to, any Governmental Authority is required on the part of Acquiror with respect to Acquiror's execution or delivery of this Agreement or the consummation of the transactions contemplated hereby, except (a) for any consents, approvals, authorizations, designations, declarations, waivers or filings, the absence of which would not, individually or in the aggregate, have, or reasonably be expected to have, a material adverse effect on the ability of Acquiror to enter into and perform its obligations under this Agreement, (b) the filing of the Proxy/Registration Statement with the SEC and (c) the filing of the Certificate of Merger with the Secretary of State of the State of Delaware, in accordance with the relevant provisions of the Delaware Act.



Section 6.8. Trust Account. As of the date of this Agreement, Acquiror has at least \$65,790,000 in the Trust Account (including \$2,257,500 payable for deferred underwriting commissions), such monies invested in United States government securities or money market funds meeting certain conditions under Rule 2a-7 promulgated under the Investment Company Act pursuant to the Investment Management Trust Agreement, dated as of May 12, 2022, between Acquiror and Wilmington Trust, National Association, as trustee (the “Trustee”) (the “Trust Agreement”). There are no separate Contracts (whether written or unwritten, express or implied) that would cause the description of the Trust Agreement in the Acquiror SEC Filings to be inaccurate or that would entitle any Person (other than shareholders of Acquiror holding Acquiror Common Stock initially sold in Acquiror’s initial public offering who shall have elected to redeem their Acquiror Common Stock pursuant to Acquiror’s Governing Documents and the underwriters of Acquiror’s initial public offering with respect to deferred underwriting commissions) to any portion of the proceeds in the Trust Account. Prior to the Share Exchange Closing, none of the funds held in the Trust Account may be released other than to pay Taxes and payments with respect to all Acquiror Share Redemptions. There are no claims or proceedings pending or, to the knowledge of Acquiror, threatened with respect to the Trust Account. Acquiror has performed all material obligations required to be performed by it to date under, and is not in default, in breach or delinquent in performance or any other respect (to the knowledge of Acquiror, claimed or actual) in connection with, the Trust Agreement, and no event has occurred which, with due notice or lapse of time or both, would constitute such a default or breach thereunder. As of the Share Exchange Closing, the obligations of Acquiror to dissolve or liquidate pursuant to Acquiror’s Governing Documents shall terminate, and as of the Share Exchange Closing, Acquiror shall have no obligation whatsoever pursuant to Acquiror’s Governing Documents to dissolve and liquidate the assets of Acquiror by reason of the consummation of the transactions contemplated hereby (other than use of the funds in the Trust Account for Acquiror Share Redemptions and to pay the underwriters of Acquiror’s initial public offering with respect to deferred underwriting commissions). To the knowledge of Acquiror, as of the date hereof, following the Share Exchange Closing, no Acquiror Shareholder shall be entitled to receive any amount in the Trust Account except to the extent such Acquiror Shareholder has exercised an Acquiror Share Redemption. As of the date hereof, assuming the accuracy of the representations and warranties of the Company contained herein and the compliance by the Company with its obligations hereunder, Acquiror does not have any reason to believe that any of the conditions to the use of funds in the Trust Account will not be satisfied or funds available in the Trust Account will not be available to Acquiror on the Share Exchange Closing Date (other than use of the funds in the Trust Account for Acquiror Share Redemptions and to pay the underwriters of Acquiror’s initial public offering with respect to deferred underwriting commissions).

Section 6.9. Investment Company Act; JOBS Act. Acquiror is not an “investment company” or a Person directly or indirectly “controlled” by or acting on behalf of an “investment company”, in each case within the meaning of the Investment Company Act. Acquiror constitutes an “emerging growth company” within the meaning of the JOBS Act.

Section 6.10. Absence of Changes. Since May 17, 2022, (a) there has not been any event or occurrence that has, or would reasonably be expected to, individually or in the aggregate, prevent or materially adversely affect the ability of Acquiror to consummate the Transactions and (b) Acquiror has, in all material respects, conducted its business and operated its properties in the ordinary course of business consistent with past practice.

Section 6.11. No Undisclosed Liabilities. Except for any Acquiror Transaction Expenses, there is no liability, debt or obligation of or claim or judgment against Acquiror (whether direct or indirect, absolute or contingent, accrued or unaccrued, known or unknown, liquidated or unliquidated, or due or to become due), except for liabilities and obligations (a) reflected or reserved for on the financial statements or disclosed in the notes thereto included in Acquiror SEC Filings, (b) that have arisen since the date of the most recent balance sheet included in the Acquiror SEC Filings in the ordinary course of business of Acquiror, or (c) which would not be, or would not reasonably be expected to be, material to the business of Acquiror.

Section 6.12. Capitalization of Acquiror.

(a) As of the date of this Agreement, the authorized share capital of Acquiror consists of (i) 400,000 shares of Acquiror Preferred Stock, none of which is issued or outstanding as of the date of this Agreement, (ii) 20,000,000 shares of Acquiror Class A Common Stock, 8,461,392 of which are issued and outstanding as of the date of this Agreement, (iii) 100,000 shares of Acquiror Class B Common Stock, none of which is issued or outstanding as of the date of this Agreement. The foregoing represents all of the issued and outstanding shares of Acquiror Stock as of the date of this Agreement. All issued and outstanding shares of Acquiror Stock (i) have been duly authorized and validly issued and are fully paid and non-assessable; (ii) have been offered, sold and issued in compliance with applicable Law, including federal and state securities Laws, and all requirements set forth in (1) Acquiror's Governing Documents, and (2) any other applicable Contracts governing the issuance of such securities; and (iii) are not subject to, nor have they been issued in violation of, any purchase option, call option, right of first refusal, preemptive right, subscription right or any similar right under any provision of any applicable Law, Acquiror's Governing Documents or any Contract to which Acquiror is a party or otherwise bound.

(b) As of the date of this Agreement, 3,225,000 Acquiror Warrants are issued and outstanding. No warrant to purchase Acquiror Common Stock has been issued other than those included in the Acquiror Units issued in the Acquiror IPO. As of the date of this Agreement, 6,450,000 Acquiror Rights are issued and outstanding. No Sponsor holds any Acquiror Right. All outstanding Acquiror Warrants and Acquiror Rights (i) have been duly authorized and validly issued and constitute valid and binding obligations of Acquiror, enforceable against Acquiror in accordance with their terms, subject to applicable bankruptcy, insolvency, fraudulent conveyance, reorganization, moratorium and similar Laws affecting creditors' rights generally and subject, as to enforceability, to general principles of equity; (ii) have been offered, sold and issued in compliance with applicable Law, including federal and state securities Laws, and all requirements set forth in (1) Acquiror's Governing Documents and (2) any other applicable Contracts governing the issuance of such securities; and (iii) are not subject to, nor have they been issued in violation of, any purchase option, call option, right of first refusal, preemptive right, subscription right or any similar right under any provision of any applicable Law, Acquiror's Governing Documents or any Contract to which Acquiror is a party or otherwise bound. Except for the Acquiror's Governing Documents and this Agreement, there are no outstanding Contracts of Acquiror to repurchase, redeem or otherwise acquire any Acquiror Securities.

(c) Except as contemplated by this Agreement or the other documents contemplated hereby, Acquiror has not granted any outstanding options, warrants, rights or other securities convertible, exercisable or exchangeable for Acquiror Securities, or any other commitments or agreements providing for the issuance of additional Equity Securities, for the repurchase or redemption of any Equity Securities or the value of which is determined by reference to the Equity Securities of Acquiror, and there are no Contracts of any kind which may obligate Acquiror to issue, purchase, redeem or otherwise acquire any Equity Securities of Acquiror.

(d) Acquiror has no Subsidiaries, and does not own, directly or indirectly, any equity interests or other interests or investments (whether equity or debt) in any Person, whether incorporated or unincorporated. Acquiror is not party to any Contract that obligates Acquiror to invest money in, loan money to or make any capital contribution to any other Person.

Section 6.13. Brokers' Fees. Except as set forth in Section 6.13 of the Acquiror Disclosure Letter, no broker, finder, investment banker or other Person is entitled to any brokerage fee, finders' fee or other commission in connection with the transactions contemplated hereby based upon arrangements made by Acquiror or any of its Affiliates.

Section 6.14. Indebtedness. Except as set forth in Acquiror Financial Statements or as permitted by Section 9.4 after the date hereof, Acquiror does not have any Indebtedness.

Section 6.15. Taxes.

(a) All material Tax Returns required to be filed by or with respect to Acquiror have been timely filed (taking into account any applicable extensions), all such Tax Returns (taking into account all amendments thereto) are true, correct and complete in all material respects and all material Taxes due and payable (whether or not shown on any Tax Return) have been paid.

(b) Acquiror has withheld from amounts owing to any employee, creditor or other Person all material Taxes required by Law to be withheld, paid over to the proper Governmental Authority in a timely manner all such withheld amounts required to have been so paid over and complied in all material respects with all applicable withholding and related reporting requirements with respect to such Taxes.

(c) There are no Liens for any material Taxes (other than Permitted Liens) upon the property or assets of Acquiror.

(d) No claim, assessment, deficiency or proposed adjustment for any material amount of Tax has been asserted in writing or assessed by any Governmental Authority against Acquiror that remains unpaid.

(e) There is no material Tax audit or other examination of Acquiror presently in progress with respect to any material Taxes, nor has Acquiror been notified in writing of any request or threat for such an audit or other examination, and there are no waivers, extensions or written requests for any waivers or extensions of any statute of limitations currently in effect with respect to any material Taxes of Acquiror.

(f) The Acquiror has not made a request for or entered into a closing agreement, private letter ruling, advance tax ruling or similar agreement with any Governmental Authority with respect to Taxes. The Acquiror has not made a change of any method of accounting with respect to any Taxes.

(g) The Acquiror is not a party to any Tax indemnification or Tax sharing or similar Tax agreement (other than any customary commercial Contracts (or Contracts entered into in the ordinary course of business) not primarily related to Taxes).

(h) The Acquiror has not been a party to any transaction treated by the parties as a distribution of stock qualifying for Tax-free treatment under Section 355 of the Code in the two (2) years prior to the date of this Agreement.

(i) The Acquiror (i) is not liable for Taxes of any other Person under Treasury Regulation Section 1.1502-6 or any similar provision of state, local or foreign Tax Law or as a transferee or successor or by Contract (other than customary commercial Contracts (or Contracts entered into in the ordinary course of business) not primarily related to Taxes) or (ii) has never been a member of an affiliated, consolidated, combined or unitary group filing for U.S. federal, state or local income Tax purposes, other than a group the common parent of which was or is the Acquiror.

(j) Since its inception, no written claim has been made by any Governmental Authority where the Acquiror does not file Tax Returns that it is or may be subject to taxation in that jurisdiction.

(k) The Acquiror has not participated in a "listed transaction" within the meaning of Treasury Regulation 1.6011-4(b)(2).

(l) Except as contemplated by this Agreement and the Transactions, Acquiror has not taken any action or agreed to take any action, nor to the knowledge of Acquiror are there any facts or circumstances, that could reasonably be expected to prevent the Transactions from qualifying for the Intended Tax Treatment.

Section 6.16. Business Activities.

(a) Since formation, Acquiror has not conducted any business activities other than activities related to Acquiror's initial public offering or directed toward the accomplishment of a Business Combination. Except as set forth in Acquiror's Governing Documents or as otherwise contemplated by this Agreement or the other Transaction Documents and the transactions contemplated hereby and thereby, there is no agreement, commitment, or Governmental Order binding upon Acquiror or to which Acquiror is a party which has or would reasonably be expected to have the effect of prohibiting or impairing any business practice of Acquiror or any acquisition of property by Acquiror or the conduct of business by Acquiror as currently conducted or as contemplated to be conducted as of the Share Exchange Closing, other than such effects, individually or in the aggregate, which have not been and would not reasonably be expected to be material to Acquiror.

(b) Except for the transactions contemplated by this Agreement and the other Transaction Documents, Acquiror does not own or have a right to acquire, directly or indirectly, any interest or investment (whether equity or debt) in any corporation, partnership, joint venture, business, trust or other entity. Except for this Agreement and the other Transaction Documents and the transactions contemplated hereby and thereby, Acquiror has no material interests, rights, obligations or liabilities with respect to, and is not party to or bound by, and does not have its assets or property subject to, in each case whether directly or indirectly, any Contract or transaction which is, or would reasonably be interpreted as constituting, a Business Combination.

(c) Except for this Agreement and the other Transaction Documents to which it is party and the other documents and transactions contemplated hereby and thereby (including with respect to Acquiror Transaction Expenses) and contracts with the underwriters of Acquiror's initial public offering, Acquiror is not party to any Contract with any other Person that would require payments by Acquiror after the date hereof in excess of \$100,000 in the aggregate with respect to any individual Contract (or in the aggregate with any series of related Contracts) other than Working Capital Loans. As of the date of this Agreement, Acquiror does not have any Working Capital Loan.

Section 6.17. Nasdaq Stock Market Quotation. The shares of Acquiror Common Stock are registered pursuant to Section 12(b) of the Exchange Act with the Nasdaq Stock Market LLC ("Nasdaq") and are listed for trading on Nasdaq Global Market under the symbol "PNAC"; the Acquiror Public Warrants are registered pursuant to Section 12(b) of the Exchange Act and are listed for trading on Nasdaq under the symbol "PNACW"; the Acquiror Rights are registered pursuant to Section 12(b) of the Exchange Act and are listed for trading on Nasdaq under the symbol "PNACR"; the Acquiror Units are registered pursuant to Section 12(b) of the Exchange Act and are listed for trading on Nasdaq under the symbol "PNACU". Acquiror is in compliance in all material respects with the rules of Nasdaq and there is no Action or proceeding pending or, to the knowledge of Acquiror, threatened against Acquiror by Nasdaq or the SEC with respect to any intention by such entity to deregister the Acquiror Common Stock, the Acquiror Public Warrants, the Acquiror Rights or the Acquiror Units or terminate the listing thereof on Nasdaq. None of Acquiror nor any of its Affiliates or Representatives has taken any action to terminate the registration of the Acquiror Common Stock, the Acquiror Public Warrants and the Acquiror Rights or the Acquiror Units under the Exchange Act except as expressly contemplated by this Agreement or any other Transaction Document.

Section 6.18. Proxy/Registration Statement. The information supplied by Acquiror Party in writing specifically for inclusion in the Proxy/Registration Statement shall not, at (a) the time the Proxy/Registration Statement is filed in accordance with Rule 424(b) and/or pursuant to Section 14A or declared effective, (b) the time the Proxy/Registration Statement (or any amendment thereof or supplement thereto) is first mailed to (i) the Acquiror Shareholders and (ii) the Company Shareholders, and (c) the time of (i) the Acquiror Shareholders' Meeting and (ii) a Seller, contain any untrue statement of a material fact or omit to state any material fact required to be stated therein or necessary in order to make the statements therein, in light of the circumstances under which they were made, not misleading.

Section 6.19. Transaction Financing. The Transaction Financing Agreements, when entered into by the PubCo and the investors in the Transaction Financing prior to the Share Exchange Closing, shall be in full force and effect with respect to, and binding on, Acquiror, and to the knowledge of Acquiror, on each investor thereto, in accordance with their terms.

Section 6.20. No Outside Reliance. Notwithstanding anything contained in this Article VI or any other provision hereof, each of Acquiror and any of its respective directors, managers, officers, employees, equityholders, partners, members or Representatives acknowledge and agree that Acquiror has made its own investigation of the Company and that neither the Company nor any of its Affiliates, agents or Representatives is making any representation or warranty whatsoever, express or implied, other than those expressly given by the Company in Article V and the Sellers in Article IV, including any implied warranty or representation as to condition, merchantability, suitability or fitness for a particular purpose or trade as to any of the assets of the Company or its Subsidiaries. Without limiting the generality of the foregoing, it is understood that any cost estimates, financial or other projections or other predictions that may be contained or referred to in the Company Disclosure Letter or elsewhere, as well as any information, documents or other materials (including any such materials contained in any "data room" (whether or not accessed by Acquiror or its Representatives) or reviewed by Acquiror Party or any of its Affiliates or its Representatives) or management presentations that have been or shall hereafter be provided to Acquiror Party or any of its Affiliates or Representatives are not and will not be deemed to be representations or warranties of the Company or any Seller, and no representation or warranty is made as to the accuracy or completeness of any of the foregoing except as may be expressly set forth in Article V and Article IV of this Agreement. Except as otherwise expressly set forth in this Agreement, Acquiror understands and agrees that any assets, properties and business of the Company and its Subsidiaries are furnished "as is", "where is" and subject to and except as otherwise provided in the representations and warranties contained in Article V and Article IV, with all faults and without any other representation or warranty of any nature whatsoever.

Section 6.21. No Additional Representation or Warranties. Except as expressly provided in this Article VI and Article VII, none of Acquiror, any of its Affiliates, or any of their respective directors, managers, officers, employees, shareholders, partners, members or Representatives has made, or is making, any representation or warranty whatsoever to the Company, any Seller or its respective Affiliates, and no such party shall be liable in respect of the accuracy or completeness of any information provided to the Company, any Seller or its respective Affiliates. Without limiting the foregoing, the Company acknowledges that the Company and its advisors, have made their own investigation of Acquiror and each Acquisition Entity and, except as provided in this Agreement, are not relying on any representation or warranty whatsoever as to the condition, merchantability, suitability or fitness for a particular purpose or trade as to any of the assets of Acquiror or any Acquiror Entity, the prospects (financial or otherwise) or the viability or likelihood of success of the business of Acquiror or any Acquiror Entity as conducted after the Share Exchange Closing, as contained in any materials provided by Acquiror or any of its Affiliates or any of their respective directors, officers, employees, shareholders, partners, members or Representatives or otherwise.

## ARTICLE VII

### REPRESENTATIONS AND WARRANTIES OF THE ACQUISITION ENTITIES

The Acquisition Entities (with respect to PubCo and New SubCo, as of the date each of which delivered its signature page hereto) jointly and severally represent and warrant to the Company and the Sellers as of the date hereof and as of the Share Exchange Closing, as follows:

Section 7.1. Organization. Such Acquisition Entity has been duly incorporated, organized or formed and is validly existing as a corporation or exempted company in good standing (or equivalent status, to the extent that such concept exists) under the Laws of its jurisdiction of incorporation, organization or formation, and has the requisite company power and authority to own, lease or operate all of its properties and assets and to conduct its business as it is now being conducted. The copies of such Acquisition Entity's Governing Documents, as amended to the date of this Agreement, previously delivered by such Acquisition Entity to the Company and Acquiror, are true, correct and complete. Such Acquisition Entity is duly licensed or qualified and in good standing as a foreign corporation or company in all jurisdictions in which its ownership of property or the character of its activities is such as to require it to be so licensed or qualified, except where the failure to be so licensed or qualified would not reasonably be expected to be, individually or in the aggregate, material to such Acquisition Entity.

Section 7.2. Due Authorization. Such Acquisition Entity has all requisite corporate power and authority to (a) execute and deliver this Agreement, the other Transaction Documents to which such Acquisition Entity is a party and the documents contemplated hereby and thereby, and (b) consummate the transactions contemplated hereby and thereby and perform all obligations to be performed by it hereunder and thereunder. The execution and delivery of this Agreement, the other Transaction Documents to which such Acquisition Entity is a party, and the documents contemplated hereby and the consummation of the transactions contemplated hereby and thereby have been (i) duly and validly authorized and approved by the board of directors of such Acquisition Entity and (ii) determined by the board of directors of such Acquisition Entity as advisable to such Acquisition Entity and such Acquisition Entity's shareholders and recommended for approval by such Acquisition Entity's shareholders. No other company proceeding on the part of such Acquisition Entity is necessary to authorize this Agreement or the other Transaction Documents to which such Acquisition Entity is a party and the documents contemplated hereby and thereby. This Agreement has been, and at or prior to the Share Exchange Closing, the other Transaction Documents to which such Acquisition Entity is a party will be, duly and validly executed and delivered by such Acquisition Entity, and this Agreement constitutes, and at or prior to the Share Exchange Closing, the other Transaction Documents to which such Acquisition Entity is a party will constitute, a legal, valid and binding obligation of such Acquisition Entity, enforceable against such Acquisition Entity in accordance with its terms, subject to applicable bankruptcy, insolvency, fraudulent conveyance, reorganization, moratorium and similar Laws affecting creditors' rights generally and subject, as to enforceability, to general principles of equity.

Section 7.3. No Conflict. The execution and delivery of this Agreement and the other Transaction Documents to which such Acquisition Entity is a party by such Acquisition Entity and the consummation of the transactions contemplated hereby and thereby do not and will not (a) violate or conflict with any provision of, or result in the breach of or default under the Governing Documents of such Acquisition Entity, (b) violate or conflict with any provision of, or result in the breach of, or default under any applicable Law or Governmental Order applicable to such Acquisition Entity, (c) violate or conflict with any provision of, or result in the breach of, result in the loss of any right or benefit, or cause acceleration, or constitute (with or without due notice or lapse of time or both) a default (or give rise to any right of termination, cancellation or acceleration) under any Contract to which such Acquisition Entity is a party or by which such Acquisition Entity may be bound, or terminate or result in the termination of any such Contract or (d) result in the creation of any Lien upon any of the properties or assets of such Acquisition Entity, except, in the case of clauses (b) through (d), to the extent that the occurrence of the foregoing does not or would not reasonably be expected to, individually or in the aggregate, prevent or materially adversely affect the ability of such Acquisition Entity to consummate the Transactions.

Section 7.4. Litigation and Proceedings. As of the date hereof (a) there are no pending or, to the knowledge of such Acquisition Entity, threatened Legal Proceedings against such Acquisition Entity, its properties or assets; and (b) there is no outstanding Governmental Order imposed upon such Acquisition Entity, nor are any properties or assets of such Acquisition Entity or its business bound or subject to any Governmental Order, except, in each case, as would not be, or reasonably be expected to be, material to the business of such Acquisition Entity.



Section 7.5. Governmental Authorities; Consents. Assuming the truth and completeness of the representations and warranties of the Company, the Sellers and Acquiror contained in this Agreement, no consent, waiver, approval or authorization of, or designation, declaration or filing with, or notification to, any Governmental Authority or other Person is required on the part of such Acquisition Entity with respect to such Acquisition Entity's execution or delivery of this Agreement or the consummation of the transactions contemplated hereby, except for the filing of the Proxy/Registration Statement with the SEC, and the Post-Combination PubCo Charter with the Cayman Registrar, and any consents, approvals, authorizations, designations, declarations, waivers or filings, the absence of which would not, individually or in the aggregate, have, or reasonably be expected to have, a material adverse effect on the ability of such Acquisition Entity to enter into and perform its obligations under this Agreement.

Section 7.6. Capitalization of Acquisition Entities. As of the date of this Agreement, (a) the authorized share capital of PubCo consists of 500,000,000 ordinary shares, par value \$0.0001 each, one (1) of which is issued and outstanding as of the date of this Agreement, (b) New SubCo is authorized to issue only ordinary shares of New SubCo, all of which are owned by PubCo, and (c) Merger Sub is authorized to issue only shares of common stock of Merger Sub, all of which are issued and outstanding and all of which are owned by PubCo. Prior to giving effect to the transactions contemplated by this Agreement, except for New SubCo and Merger Sub, PubCo has no Subsidiaries, and does not own, directly or indirectly, any equity interests or other interests or investments (whether equity or debt) in any Person, whether incorporated or unincorporated. Prior to giving effect to the transactions contemplated by this Agreement, neither New SubCo nor Merger Sub has any Subsidiary or owns directly or indirectly, any equity interests or other interests or investments (whether equity or debt) in any Person, whether incorporated or unincorporated. No Acquisition Entity is a party to any Contract that obligates PubCo, Merger Sub or New SubCo to invest money in, loan money to or make any capital contribution to any other Person.

Section 7.7. Brokers' Fees. No broker, finder, investment banker or other Person is entitled to any brokerage fee, finders' fee or other commission in connection with the transactions contemplated hereby based upon arrangements made by such Acquisition Entity.

Section 7.8. Business Activities. Since formation, such Acquisition Entity has not conducted any business activities other than those directed toward the consummation of the Transactions. Except as set forth in such Acquisition Entity's Governing Documents or as otherwise contemplated by this Agreement or the other Transaction Documents and the transactions contemplated hereby and thereby, there is no agreement, commitment, or Governmental Order binding upon such Acquisition Entity or to which such Acquisition Entity is a party which has or would reasonably be expected to have the effect of prohibiting or impairing any business practice of such Acquisition Entity or any acquisition of property by such Acquisition Entity or the conduct of business by such Acquisition Entity as currently conducted or as contemplated to be conducted as of the Share Exchange Closing, other than such effects, individually or in the aggregate, which have not been and would not reasonably be expected to be material to such Acquisition Entity.

Section 7.9. Consideration Shares. The Aggregate Merger Consideration and Aggregate Exchange Consideration, when issued in accordance with the terms hereof, shall be duly authorized and validly issued and allotted, fully paid and non-assessable and issued or allotted in compliance with all applicable Law, including state and federal securities Laws, and not subject to, and not issued in violation of, any Lien, purchase option, call option, right of first refusal, preemptive right, subscription right or any similar right under any provision of applicable Law, PubCo's Governing Documents, or any Contract to which PubCo is a party or otherwise bound.

Section 7.10. Foreign Private Issuer and Emerging Growth Company. Prior to giving effect to the transactions contemplated by this Agreement, other than New SubCo and Merger Sub, PubCo does not have any Subsidiaries or own any equity interests in any other Person. PubCo is and shall be at all times commencing from the date thirty (30) days prior to the first filing of the Proxy/Registration Statement with the SEC through the Share Exchange Closing, (a) a foreign private issuer as defined in Rule 405 under the Securities Act and (b) an "emerging growth company" as that term is defined in the JOBS Act.

Section 7.11. Investment Company Act. None of the Acquisition Entities is an "investment company" or, a Person directly or indirectly controlled by or acting on behalf of an "investment company", in each case within the meanings of the Investment Company Act.

Section 7.12. Intended Tax Treatment. Except as contemplated by this Agreement and the Transactions, such Acquisition Entity has not taken any action or agreed to take any action, nor to the knowledge of such Acquisition Entity are there any facts or circumstances, that could reasonably be expected to prevent the Transactions from qualifying for the Intended Tax Treatment.

## ARTICLE VIII

### COVENANTS OF THE COMPANY & THE SELLERS

Section 8.1. Company Conduct of Business. From the date of this Agreement through the earlier of the Share Exchange Closing or valid termination of this Agreement pursuant to Article XII (the "Interim Period"), the Company shall, and shall cause its Subsidiaries to, except (i) as otherwise explicitly contemplated by this Agreement, the other Transaction Documents or the Permitted Activities Documents, (ii) as required by Law or (iii) as consented to by Acquiror in writing (which consent shall not be unreasonably conditioned, withheld, delayed or denied), (A) use reasonable best efforts to operate its business in the ordinary course consistent with past practice; and (B) comply with its Governing Documents, except solely in the case of any Subsidiary of the Company, where non-compliance by such Subsidiary would not be material to the business of the Company and its Subsidiaries taken as a whole. Without limiting the generality of the foregoing, except as set forth on Section 8.1 of the Company Disclosure Letter or as consented to by Acquiror in writing (which consent shall not be unreasonably conditioned, withheld, or delayed), the Company shall not, and the Company shall cause its Subsidiaries not to, except as otherwise contemplated by this Agreement, the Permitted Activities Documents or the other Transaction Documents or required by Law:

(a) change or amend the Governing Documents of the Company or any of the Company's Subsidiaries, except in the case of any of the Company's Subsidiaries only, for any such change or amendment made in the ordinary course of business and which is not material to the business of the Company and its Subsidiaries taken as a whole;

(b) make or declare any dividend or distribution to the shareholders of the Company or make any other distributions in respect of any Equity Securities of the Company;

(c) (i) split, combine, reclassify, recapitalize or otherwise amend any terms of any shares or series of the Company's or any of its Subsidiaries' Equity Securities, except for any such transaction by a Subsidiary of the Company that remains a Subsidiary of the Company after consummation of such transaction; or (ii) amend any term or alter any rights of any of its outstanding Equity Securities;

(d) purchase, repurchase, redeem or otherwise acquire any issued and outstanding share capital or outstanding Equity Securities of the Company or its Subsidiaries, except for (i) the acquisition by the Company or any of its Subsidiaries of any shares or Equity Securities of the Company or its Subsidiaries in connection with the forfeiture or cancellation of such interests in accordance with the terms of the applicable Contracts as in effect on the date hereof and (ii) transactions between the Company and any wholly-owned Subsidiary of the Company or between wholly-owned Subsidiaries of the Company;

(e) enter into, modify in any material respect or terminate (other than expiration in accordance with its terms) any Material Contract, other than (i) in the ordinary course of business consistent with past practice or as required by Law or (ii) in connection with the payment or discharge of obligations to creditors of the Company in furtherance of the consummation of the Share Exchange;

(f) sell, assign, transfer, convey, lease, exclusively license or otherwise dispose of any material tangible assets or properties of the Company or its Subsidiaries, except for (i) dispositions of obsolete or worthless equipment, (ii) transactions among the Company and its Subsidiaries or among its wholly-owned Subsidiaries and (iii) transactions in the ordinary course of business consistent with past practice;

(g) except (y) as otherwise required by Law or (z) pursuant to the Material Contracts, (i) grant any equity or equity based awards or other severance, retention, change in control or termination or similar pay, except in connection with the promotion, hiring or termination of employment of any employee in the ordinary course of business consistent with past practice, (ii) make any change in the key management structure of the Company, including the hiring of additional officers (other than such hiring in the ordinary course of business consistent with past practice) or the termination of existing officers, other than terminations for cause or due to death or disability, (iii) terminate, adopt, enter into or materially amend any Company Benefit Plan, or (iv) materially increase the cash compensation or bonus opportunity of any officer or director except in the ordinary course of business consistent with past practice and pursuant to existing Company Benefit Plans as in effect on the date hereof;

(h) (i) acquire (whether by merger, consolidation, amalgamation, scheme or similar transaction, purchase of securities of or otherwise) any corporation, partnership, association, joint venture or other business organization or division thereof, (ii) make any acquisition of, or investment in, a business, by purchase of stock, securities or assets, contributions to capital, or loans or advances, with a value or purchase price in excess of \$200,000 individually or \$200,000 in the aggregate, other than cash management by the Company or its Subsidiaries of the Company's Subsidiaries, (iii) enter into any closing agreement in respect of material Taxes or enter into any Tax sharing or similar agreement (other than any such agreement solely between the Company and its existing Subsidiaries, and customary commercial Contracts not primarily related to Taxes), or (iv) settle any claim or assessment in respect of material Taxes;

(i) issue or sell any debt securities or warrants or other rights to acquire any debt securities of the Company or any Subsidiary of the Company or otherwise incur, assume or guarantee or otherwise become liable for any Indebtedness, except (i) in a principal amount not exceeding \$200,000, (ii) borrowings under credit agreements disclosed in Section 8.1 of the Company Disclosure Letter, in the form that exists on the date hereof, or (iii) the ordinary course funding and cash management by the Company or its Subsidiaries of the Company's Subsidiaries;

(j) make or change any material election in respect of material Taxes, materially amend, modify or otherwise change any filed material Tax Return, adopt or request permission of any Tax authority to change any accounting method in respect of material Taxes, or consent to any extension or waiver of the limitation period applicable to any claim or assessment in respect of material Taxes or with respect to any material Tax attribute that would give rise to any claim or assessment of Taxes;

(k) take any action, or knowingly fail to take any action, where such action or failure to act could reasonably be expected to prevent the Transactions from qualifying for the Intended Tax Treatment;

(l) issue any additional Company Ordinary Shares, Equity Securities or securities exercisable for or convertible or exchangeable into Company Ordinary Shares or other Equity Securities of the Company;

(m) adopt a plan of, or otherwise enter into or effect a, complete or partial liquidation, dissolution, restructuring, recapitalization or other reorganization of the Company or its Subsidiaries;

(n) waive, release, settle, compromise or otherwise resolve any inquiry, investigation, claim, Action, litigation or other Legal Proceedings, except in the ordinary course of business or where such waivers, releases, settlements or compromises involve only the payment of monetary damages in an amount less than \$200,000 in the aggregate;

(o) grant to, or agree to grant to, any Person rights to any Intellectual Property or software that is material to the Company and its Subsidiaries, taken as a whole, or dispose of, abandon or permit to lapse any rights to any Intellectual Property that is material to the business of the Company and its Subsidiaries, taken as a whole, except for the expiration of Company Registered Intellectual Property in accordance with the applicable statutory term (or in the case of domain names, applicable registration period) or in the reasonable exercise of the Company's or any of its Subsidiaries' business judgment as to the costs and benefits of maintaining the item;

(p) make or commit to make capital expenditures other than in an amount not in excess of \$200,000 in the aggregate;

(q) manage the Company's and its Subsidiaries' working capital (including paying amounts payable in a timely manner when due and payable) in a manner other than in the ordinary course of business consistent with past practice;

(r) terminate without replacement, or fail to use reasonable efforts to maintain any License material to the conduct of the business of the Company and its Subsidiaries, taken as a whole;

(s) waive the restrictive covenant obligations of any current or former employee of the Company or any of the Company's Subsidiaries;

(t) (i) limit the right of the Company or any of the Company's Subsidiaries to engage in any line of business or in any geographic area, to develop, market or sell products or services, or to compete with any Person or (ii) grant any exclusive or similar rights to any Person, in each case, except where such limitation or grant does not, and would not be reasonably likely to, individually or in the aggregate, materially and adversely affect, or materially disrupt, the ordinary course operation of the businesses of the Company and its Subsidiaries, taken as a whole;

(u) terminate without replacement or amend in a manner materially adverse to the Company and its Subsidiaries, taken as a whole, any insurance policy insuring any risks of the business of the Company or any of the Company's Subsidiaries;

(v) make any material change in its accounting principles or methods unless required by FRSs or applicable Law or, to the extent applicable to the Company or a Subsidiary, applicable local accounting standards; or

(w) enter into any agreement to do any action prohibited under this Section 8.1.

Section 8.2. Inspection. Subject to confidentiality obligations and similar restrictions that may be applicable to information furnished to the Company or any of the Company's Subsidiaries by third parties that may be in the Company's or any of its Subsidiaries' possession from time to time, and except for any information that is subject to attorney-client privilege, and to the extent permitted by applicable Law, the Company shall, and shall cause its Subsidiaries to, afford to Acquiror, PubCo, New SubCo and their respective Representatives reasonable access during the Interim Period, during normal business hours and with reasonable advance written notice, in such manner as to not materially interfere with the ordinary course of business of the Company and its Subsidiaries, to their respective properties, books, Contracts, Tax Returns, legal proceedings, commitments, records and appropriate officers and employees of the Company and its Subsidiaries, and shall furnish such representatives with financial and operating data and other information concerning the affairs of the Company and its Subsidiaries that are in the possession or control of the Company or its Subsidiaries as such representatives may reasonably request, for the purposes of and in connection with the Transactions. All information obtained by Acquiror, New SubCo, PubCo or their respective Representatives pursuant to this Section 8.2 shall be subject to the confidentiality requirements under this Agreement.

Section 8.3. Preparation and Delivery of Additional Company Financial Statements.

(a) As soon as reasonably practicable following the date hereof, the Company shall deliver to Acquiror and PubCo (i) an audited consolidated statement of financial positions and consolidated statements of comprehensive income, changes in equity and cash flows of the Company and its Subsidiaries as of and for the years ended June 30, 2021 and June 30, 2022, together with the auditor's reports thereon, which comply in all material respects with the applicable accounting requirements (including the standards of the PCAOB) and with the rules and regulations of the SEC, the Exchange Act and the Securities Act applicable to a registrant (the "PCAOB Financial Statements").

(b) Upon delivery of the PCAOB Financial Statements, such financial statements shall (i) be deemed to be included in "Audited Financial Statements" for the purposes of this Agreement and the representations and warranties set forth in Section 5.9 shall be deemed to apply to such Audited Financial Statements *mutatis mutandis* with the same force and effect as if the financial statements delivered in accordance with Section 8.3 were delivered prior to the date of this Agreement.

(c) Each of the Company and the Acquiring Parties and shall each use its respective reasonable best efforts to (i) assist the other, upon advance written notice, during normal business hours and in a manner such as to not unreasonably interfere with the normal operation of the Company, any of its Subsidiaries, PubCo, Merger Sub, New SubCo or Acquiror, in preparing in a timely manner other financial information or statements (including customary pro forma financial statements) that are required to be included in the Proxy/Registration Statement and any other filings to be made by PubCo, Acquiror or the Company with the SEC in connection with the Transactions, and (ii) to obtain the consent of its auditors with respect thereto as may be required by applicable Law or requested by the SEC in connection therewith.

Section 8.4. Alternative Proposals. From the date hereof until the Share Exchange Closing Date or, if earlier, the termination of this Agreement in accordance with Article XII, the Company and its Subsidiaries shall not, and shall direct its controlled, controlling and common control Affiliates, and its and their respective Representatives not to, directly or indirectly, (a) solicit, initiate or pursue any inquiry, indication of interest, proposal or offer relating to an Alternative Proposal, (b) participate in or continue any discussions or negotiations with any third party with respect to, or furnish or make available, any information concerning the Company or any of its Subsidiaries to any third party relating to an Alternative Proposal or provide to any third-party access to the businesses, properties, assets or personnel of the Company or any of its Subsidiaries, in each case for the purpose of encouraging or facilitating an Alternative Proposal, or (c) enter into any binding understanding, binding arrangement, acquisition agreement, merger agreement or similar definitive agreement, or any letter of intent, memorandum of understanding or agreement in principle, or any other agreement with respect to an Alternative Proposal, or (d) grant any waiver, amendment or release under any confidentiality agreement or otherwise knowingly facilitate any such inquiries, proposals, discussions, or negotiations or any effort or attempt by any Person to make, an Alternative Proposal. From and after the date hereof, the Company shall, and shall instruct its officers and directors to, and the Company shall instruct and cause its Representatives, Subsidiaries and their respective Representatives to, immediately cease and terminate all discussions and negotiations with any Persons (other than Acquiror and its Representatives) with respect to an Alternative Proposal.

Section 8.5. Exchange Listing. From the date of this Agreement through the earlier of the Share Exchange Closing and termination of this Agreement, the Company shall provide all reasonable assistance reasonably required by PubCo in order for PubCo to cause the PubCo Securities to be issued in connection with the Transactions to be approved for listing on Nasdaq and accepted for clearance by the DTC, subject to official notice of issuance, prior to the Share Exchange Closing Date.

Section 8.6. Notice of Developments. From and after the date of this Agreement until the earlier of the Share Exchange Closing or the termination of this Agreement in accordance with its terms, the Company shall promptly (and in any event prior to the Share Exchange Closing) notify Acquiror in writing, upon the Company or any of its Subsidiaries becoming aware (awareness being determined with reference to the knowledge of the Company) of: (a) the occurrence or non-occurrence of any event the occurrence or non-occurrence of which has caused or is reasonably likely to cause any condition to the obligations of the Company to effect the Transactions not to be satisfied, (b) any breach of a representation or warranty given by the Company in this Agreement, or (c) any notice or other communication from any Governmental Authority which is reasonably likely, individually or in the aggregate, to have a material adverse effect on the ability of the parties hereto to consummate the Transactions or to materially delay the timing thereof. The delivery of any notice pursuant to this Section 8.6 shall not cure any breach of any representation or warranty made by the Company as of the date of this Agreement but shall supplement the disclosure letter delivered by the Company on the date hereof and qualify the representations and warranties given by the Company in Article V.

Section 8.7. No Trading. The Company and each Seller acknowledges and agrees that it is aware, and that its Affiliates have been made aware of the restrictions imposed by U.S. federal securities laws and the rules and regulations of the SEC promulgated thereunder or otherwise and other applicable foreign and domestic Laws on a Person possessing material nonpublic information about a publicly traded company. The Company and each Seller hereby agrees that while it is in possession of such material nonpublic information, it shall not and shall cause its Subsidiaries not to purchase or sell any securities of Acquiror in violation of such Laws.

Section 8.8. Support of Share Exchange. Sellers shall exercise their rights as the shareholder of the Company in so far as it is able to consummate and procure the consummation of the Share Exchange and the Company shall use its best effort to cause and support the Sellers to consummate and procure the consummation of the Share Exchange.

## ARTICLE IX

### COVENANTS OF ACQUIROR PARTIES

Section 9.1. Trust Account Proceeds. Upon satisfaction or waiver of the conditions set forth in Article XI and provision of notice thereof to the Trustee (which notice Acquiror shall be provided to the Trustee in accordance with the terms of the Trust Agreement), (a) in accordance with and pursuant to the Trust Agreement, at the Share Exchange Closing, Acquiror (i) shall cause any documents, opinions and notices required to be delivered to the Trustee pursuant to the Trust Agreement to be so delivered and (ii) shall use its reasonable best efforts to cause the Trustee to, and the Trustee shall thereupon be obligated to (A) pay as and when due all amounts payable to Acquiror Shareholders pursuant to the Acquiror Share Redemptions, (B) pay the amounts due to the underwriters of Acquiror's initial public offering for their deferred underwriting commission as set forth in the Trust Agreement, (C) pay any accrued and unpaid Acquiror Transaction Expenses and Company Transaction Expenses in accordance with Section 3.5 to the extent not previously paid, and (D) pay all remaining amounts then available in the Trust Account to Acquiror in accordance with the Trust Agreement, and (b) thereafter, the Trust Account shall terminate, except as otherwise expressly provided in the Trust Agreement.



Section 9.2. Nasdaq Listing. From the date of this Agreement through the closing of the Merger, (a) Acquiror shall use its reasonable best efforts to ensure Acquiror remains listed as a public company on Nasdaq, and (b) PubCo shall apply for, and shall use reasonable best efforts to cause, the PubCo Ordinary Shares to be issued in connection with the Transactions to be approved for listing on the Nasdaq and accepted for clearance by the DTC, subject to official notice of issuance, on or prior to the Share Exchange Closing Date. After the date hereof and prior to the Share Exchange Closing, Acquiror Parties shall procure the reservation of the ticker symbol on Nasdaq that is mutually agreed to by the Company and Acquiror.

Section 9.3. No Solicitation. From the date hereof until the Share Exchange Closing Date or, if earlier, the termination of this Agreement in accordance with Article XII, each Acquiror Party shall not, and shall direct any of the Sponsor and its controlled Affiliates and its and their respective officers, directors and Representatives not to, directly or indirectly (a) solicit, initiate, or pursue any inquiry, indication of interest, proposal or offer relating to an Acquiror Acquisition Proposal, (b) participate in or continue any discussions or negotiations with any third-party with respect to, or furnish or make available, any information concerning Acquiror to any third party relating to an Acquiror Acquisition Proposal, or provide to any third-party access to the businesses, properties, assets or personnel of Acquiror, in each case for the purpose of encouraging or facilitating an Acquiror Acquisition Proposal or (c) enter into any binding understanding, binding arrangement, acquisition agreement, merger agreement or similar definitive agreement, or any letter of intent, memorandum of understanding or agreement in principle, or any other agreement with respect to an Acquiror Acquisition Proposal, or (d) grant any waiver, amendment or release under any confidentiality agreement or otherwise knowingly facilitate any such inquiries, proposals, discussions, or negotiations or any effort or attempt by any Person to make, an Acquiror Acquisition Proposal. From and after the date hereof, each Acquiror Party shall, and shall direct any of the Sponsors and its controlled Affiliates and its and their respective officers, directors and Representatives to, immediately cease and terminate all discussions and negotiations with any Persons (other than the Company and its Representatives) with respect to an Acquiror Acquisition Proposal.

Section 9.4. Conduct of Business. During the Interim Period, each Acquiror Party shall, except (i) as otherwise explicitly contemplated by this Agreement or the other Transaction Documents or its Governing Documents, (ii) as required by Law, or (iii) as consented to by the Company in writing (which consent shall not be unreasonably conditioned, withheld, or delayed), (A) use reasonable best efforts to operate its business in the ordinary course consistent with past practice; and (B) comply in all material respects with its Governing Documents. Without limiting the generality of the foregoing, except as consented to by the Company in writing (which consent shall not be unreasonably conditioned, withheld or delayed) Acquiror shall not, and PubCo shall cause its Subsidiaries not to, except as otherwise contemplated by this Agreement or the other Transaction Documents or as required by Law:

(a) change, modify or amend the Trust Agreement (in the case of Acquiror only) or its Governing Documents, or seek any approval from its shareholders to do so, except as contemplated by the Transaction Proposals;

(b) merge, consolidate or amalgamate with or into, or acquire (by purchasing a substantial portion of the assets of or equity in, or by any other manner) any other Person or be acquired by any other Person;

(c) (x) make or declare any dividend or distribution to its shareholders or make any other distributions in respect of any of its Equity Securities, (y) split, combine, reclassify or otherwise amend any terms of its Equity Securities, or (z) purchase, repurchase, redeem or otherwise acquire any of its issued and outstanding Equity Securities, other than, in the case of Acquiror only, redemptions of Acquiror Common Stock made as part of the Acquiror Share Redemptions;

(d) except in the ordinary course of business consistent with past practice, (A) make or change any material election in respect of material Taxes, (B) materially amend, modify or otherwise change any filed material Tax Return, (C) adopt or request permission of any Tax authority to change any accounting method in respect of material Taxes, (D) enter into any closing agreement in respect of material Taxes or enter into any Tax sharing or similar agreement (other than customary commercial Contracts not primarily related to Taxes), (E) settle any claim or assessment in respect of material Taxes, or (F) consent to any extension or waiver of the limitation period applicable to any claim or assessment in respect of material Taxes or with respect to any material Tax attribute that would give rise to any claim or assessment of Taxes;

(e) except as contemplated by this Agreement or the Transactions, take any action, or knowingly fail to take any action, where such action or failure to act could reasonably be expected to prevent the Transactions from qualifying for the Intended Tax Treatment;

(f) other than as expressly required by any Transaction Document, enter into, renew or amend in any material respect, any Contract with any of the Sponsors or an Affiliate of Acquiror Party (including (i) any Person in which any of the Sponsors has a direct or indirect legal or beneficial ownership interest of five percent (5%) or greater and (ii) any Person who has a direct or indirect legal or beneficial ownership interest of five percent (5%) or greater in any of the Sponsors);

(g) incur, guarantee or otherwise become liable for any Indebtedness, other than (i) liabilities incurred in the ordinary course of business and in an amount, individually or in the aggregate, not to exceed \$100,000 and (ii) any Acquiror Transaction Expenses;

(h) other than, in the case of Acquiror only, (1) issuances of new Acquiror convertible notes to Sponsors or their designees/affiliates in respect of the capitalization of any Working Capital Loans in the aggregate amount of no more than \$3,000,000 or (2) issuance of Equity Securities of Acquiror in connection with the Transaction Financing in accordance with the Transaction Financing Agreements, and in the case of PubCo only, issuance of new PubCo securities in connection with the Transaction Financing in accordance with the Transaction Financing Agreements, (A) issue any Equity Securities or securities exercisable for or convertible into Equity Securities, (B) grant any options, warrants or other equity-based awards with respect to any Equity Securities not outstanding on the date hereof, or (C) other than pursuant to the Transaction Documents, amend, modify or waive any of the terms or rights set forth in any Acquiror Warrant or the Warrant Agreement, including any amendment, modification or reduction of the warrant price set forth therein;

(i) make any change in its accounting principles or methods unless required by GAAP;

(j) form any Subsidiary or commence any new line of business;

(k) liquidate, dissolve, reorganize or otherwise wind-up its business and operations;

(l) amend, wave or assign any material right under any material Contract to which it is a party; waive, release, assign, settle or compromise any claim, action or proceeding (including any suit, action, claim, proceeding or investigation relating to this Agreement or the transactions contemplated hereby), other than waivers, releases, assignments, settlements or compromises that involve only the payment of monetary damages (and not the imposition of equitable relief on, or the admission of wrongdoing by, Acquiror or its Subsidiary) not in excess of \$1,000,000 (individually or in the aggregate), or otherwise pay, discharge or satisfy any Actions, Liabilities or obligations, in each case due and payable only before the Share Exchange Closing; or

(m) enter into any agreement to do any action prohibited under this Section 9.4.

Section 9.5. Public Filings. From the date hereof through the Share Exchange Closing, Acquiror Parties shall keep current and timely file all reports required to be filed or furnished with the SEC and otherwise comply in all material respects with its reporting obligations under applicable Laws.

Section 9.6. Shareholder Litigation. Without limiting Section 9.4 above, in the event that any litigation related to this Agreement, any other Transaction Document or the transactions contemplated hereby or thereby is brought, or, to the knowledge of Acquiror, threatened in writing, against any Acquiror Party or the board of directors of any Acquiror Party by any Acquiror Shareholders prior to the Share Exchange Closing, such Acquiror Party shall promptly after becoming aware of such litigation notify the Company of any such litigation and keep the Company reasonably informed with respect to the status thereof. Acquiror Parties shall provide the Company the opportunity to participate in (at its own cost and subject to a customary joint defense agreement), but not control, the defense of any such litigation, and shall consider in good faith the Company's suggestions with respect to such litigation and shall not settle any such litigation without the prior written consent of the Company, such consent not to be unreasonably withheld, conditioned, delayed or denied.

Section 9.7. Section 16 Matters. Prior to the Share Exchange Closing Date, Acquiror Parties shall take all such steps (to the extent permitted under applicable Law) as are reasonably necessary to cause any acquisition or disposition of PubCo Securities or any derivative thereof that occurs or is deemed to occur by reason of or pursuant to the Transactions by each Person who is or will be or may become subject to Section 16 of the Exchange Act with respect to PubCo, including by virtue of being deemed a director by deputization, to be exempt under Rule 16b-3 promulgated under the Exchange Act.

Section 9.8. PubCo Equity Plan. On the Merger Closing, PubCo shall have adopted an equity incentive plan substantially in the form attached hereto as Exhibit E prior to the Merger Closing ("PubCo ESOP").

Section 9.9. PubCo Charter. Acquiror and Acquisition Entities shall take all such action to procure that at the Merger Closing, PubCo's Governing Documents, as in effect immediately prior to the Share Exchange Closing, shall have read in their entirety in the form of the amended and restated memorandum and articles of association of PubCo substantially in the form attached hereto as Exhibit F (the "Post-Combination PubCo Charter"), and, as so amended and restated, the Post-Combination PubCo Charter shall be the memorandum and articles of association of PubCo, until thereafter amended in accordance with the terms thereof and the Cayman Companies Act. At the Merger Closing, the new name of PubCo will be "noco-noco Inc." or such other name as provided to the PubCo by the Company and stated in the Post-Combination PubCo Charter.

Section 9.10. Support of Share Exchange. PubCo shall exercise its rights as the sole shareholder of New SubCo in so far as it is able to cause and support New SubCo to consummate and procure the consummation of the Share Exchange. Acquiror shall use best efforts to procure the extension of its term prior to May 16, 2023 in accordance with Acquiror's Governing Documents if the Merger Closing is not reasonably expected to occur prior to May 16, 2023.

Section 9.11. Notice of Development. From and after the date of this Agreement until the earlier of the Share Exchange Closing or the termination of this Agreement in accordance with its terms, the Acquiror shall promptly (and in any event prior to the Share Exchange Closing) notify Acquiror in writing, upon any Acquiror Party becoming aware (awareness being determined with reference to the knowledge of the Acquiror) of: (a) the occurrence or non-occurrence of any event the occurrence or non-occurrence of which has caused or is reasonably likely to cause any condition to the obligations of any Acquiror Party to effect the Transactions not to be satisfied, (b) any breach of a representation or warranty given by Acquiror in this Agreement or Acquisition Entity in this Agreement or (c) any notice or other communication from any Governmental Authority which is reasonably likely, individually or in the aggregate, to have a material adverse effect on the ability of the parties hereto to consummate the Transactions or to materially delay the timing thereof. The delivery of any notice pursuant to this Section 9.11 shall not cure any breach of any representation or warranty made by the Acquiror Parties but shall supplement the disclosure letter delivered by the Acquiror on the date hereof and qualify the representations and warranties given by the Acquiror Parties in this Agreement.

Section 9.12. Transaction Financing Efforts. Acquiror Parties shall have used reasonable best efforts to obtain equity financing (the “Transaction Financing”) on the terms mutually agreed to by the Company and Acquiror, in an amount that is at least \$20,000,000 prior to or upon the Share Exchange Closing.

## ARTICLE X

### JOINT COVENANTS

#### Section 10.1. Regulatory Approvals; Other Filings.

(a) Each of the Company and the Acquiror Parties shall use its respective commercially reasonable efforts to cooperate in good faith with any Governmental Authority and use its commercially reasonable efforts to undertake promptly any and all action required to obtain any necessary regulatory approvals, consents, Actions, nonactions or waivers in connection with the Transactions (the “Regulatory Approvals”) as soon as reasonably practicable and any and all action necessary to consummate the Transactions as contemplated hereby. Each of the Company and the Acquiror Parties shall use its respective commercially reasonable efforts to cause the expiration or termination of the waiting, notice or review periods under any applicable Regulatory Approval with respect to the Transactions as promptly as reasonably possible after the execution of this Agreement.

(b) With respect to each of the above filings, and any other requests, inquiries, Actions or other proceedings by or from Governmental Authorities, each of the Company and Acquiror shall (and, to the extent required, shall cause its controlled Affiliates to) (i) diligently and expeditiously defend and use reasonable best efforts to obtain any necessary clearance, approval, consent, or Governmental Authorization under Laws prescribed or enforceable by any Governmental Authority for the transactions contemplated by this Agreement and to resolve any objections as may be asserted by any Governmental Authority with respect to the transactions contemplated by this Agreement; and (ii) cooperate in good faith with each other in the defense of such matters. To the extent not prohibited by Law, the Company, on the one hand, and Acquiror Parties, on the other, shall (and shall cause its Subsidiaries to) promptly furnish to Acquiror, and Acquiror shall promptly furnish to the Company, copies of any notices or written communications received by such party or any of its Affiliates from any third party or any Governmental Authority with respect to the transactions contemplated hereby, and each party shall permit counsel to the other parties an opportunity to review in advance, and each party shall consider in good faith the views of such counsel in connection with, any proposed written communications by such party and/or its Affiliates to any Governmental Authority concerning the transactions contemplated hereby; provided, that none of the parties shall extend any waiting period or comparable period or enter into any agreement with any Governmental Authority without the written consent of the other parties. To the extent not prohibited by Law, the Company agrees to provide Acquiror and its counsel, and Acquiror agrees to provide the Company and its counsel, the opportunity, on reasonable advance notice, to participate in any substantive meetings or discussions, either in person or by telephone, between such party and/or any of its Affiliates, agents or advisors, on the one hand, and any Governmental Authority, on the other hand, concerning or in connection with the transactions contemplated hereby.

(c) Subject to Section 13.6, the Company, on the one hand, and Acquiror Parties, on the other, shall each be responsible for and pay one-half of the cost for the preparation, filing and other related fees in connection with the Regulatory Approvals.

Section 10.2. Proxy/Registration Statement.

(a) Proxy/Registration Statement and Prospectus.

(i) As promptly as reasonably practicable after the execution of this Agreement, the Company and the Acquiror Parties shall prepare, and PubCo shall file with the SEC, a registration statement on Form F-4 (as amended or supplemented from time to time, and including a proxy statement, the "Proxy/Registration Statement") among other things, registering the PubCo Securities issuable to the holders of Acquiror Securities prior to the Merger Effective Time and the holders of Company Ordinary Shares pursuant to this Agreement, and relating to the Acquiror Shareholders' Meeting to approve and adopt: (A) the Merger and the Certificate of Merger, (B) this Agreement, the other Transaction Documents, and the Business Combination, (C) the adjournment of the Acquiror Shareholders' Meeting, if necessary, to permit further solicitation of proxies because there are not sufficient votes to approve and adopt any of the foregoing or any proposal in (D), and (D) any other proposals as the SEC (or staff member thereof) may indicate are necessary in its comments to the Proxy/Registration Statement or correspondence related thereto and any other proposals as reasonably agreed by Acquiror and the Company to be necessary or appropriate in connection with the transactions contemplated hereby (such proposals in (A) through (D), collectively, the "Transaction Proposals").

(ii) Acquiror Parties and the Company shall (and the Company shall cause each of its Subsidiaries to) each use its commercially reasonable efforts to (1) cause the Proxy/Registration Statement when filed with the SEC to comply in all material respects with all Laws applicable thereto and rules and regulations promulgated by the SEC, (2) respond as promptly as reasonably practicable to and resolve all comments received from the SEC concerning the Proxy/Registration Statement, (3) cause the Proxy/Registration Statement to be declared effective under the Securities Act as promptly as practicable and (4) keep the Proxy/Registration Statement effective as long as is necessary to consummate the Transactions. Prior to the effective date of the Proxy/Registration Statement, the Company, PubCo, Acquiror and New SubCo shall (and the Company shall cause each of its Subsidiaries to) use its commercially reasonable efforts to take all or any action required under any applicable federal or state securities Laws in connection with the issuance of PubCo Securities pursuant to this Agreement. Each of the Company, PubCo, Acquiror and New Sub also agrees to (and shall cause each of its Subsidiaries to) use its commercially reasonable efforts to obtain all necessary state securities law or "Blue Sky" permits and approvals required to carry out the Transactions, and the Company shall furnish all information concerning the Company and its Subsidiaries and any of their respective members or shareholders as may be reasonably requested in connection with any such action.

(iii) Each of Acquiror Parties and the Company shall furnish to the other parties all information concerning itself, its Subsidiaries, officers, directors, managers, shareholders, and other equityholders and information regarding such other matters as may be reasonably necessary or advisable or as may be reasonably requested in connection with the Proxy/Registration Statement, or any other statement, filing, notice or application made by or on behalf of Acquiror Parties, the Company or their respective Affiliates to any regulatory authority (including the Nasdaq) in connection with the Transactions.

(iv) Subject to Section 13.6, the Company, on the one hand, and Acquiror, on the other, shall each be responsible for and pay one-half of the cost for the preparation, filing and mailing of the Proxy/Registration Statement and other related fees including tax filing related matters arising from the preparation, filing and other related fees and necessary legal opinion that may be requested by the SEC in connection with the Intended Tax Treatment, provided that any fees and expenses arising from the legal and/or tax opinion prepared for analyzing the tax treatment of the Merger shall be borne by the Acquiror Parties. The Company shall be responsible for reasonable costs actually incurred for the establishment of PubCo and New SubCo and other related organization and maintenance expenses arising with respect to PubCo and New SubCo.

(v) Any filing of, or amendment or supplement to, the Proxy/Registration Statement will be mutually prepared and agreed upon by Acquiror Parties and the Company. PubCo will advise the Company and Acquiror, promptly after receiving notice thereof, of the time when the Proxy/Registration Statement has become effective or any supplement or amendment has been filed, of the issuance of any stop order, of the suspension of the qualification of any PubCo Securities to be issued or issuable in connection with this Agreement for offering or sale in any jurisdiction, or of any request by the SEC for amendment of the Proxy/Registration Statement or comments thereon and responses thereto or requests by the SEC for additional information and responses thereto, and shall provide the Company or Acquiror (as applicable) a reasonable opportunity to provide comments and amendments to any such filing. Acquiror Parties and the Company shall cooperate and mutually agree upon (such agreement not to be unreasonably withheld or delayed) any response to comments of the SEC or its staff with respect to the Proxy/Registration Statement and any amendment to the Proxy/Registration Statement filed in response thereto.

(vi) Each of Acquiror Parties and the Company shall ensure that none of the information supplied by it or on its behalf for inclusion or incorporation by reference in (A) the Proxy/Registration Statement will, at the time the Proxy/Registration Statement is filed with the SEC, at each time at which it is amended and at the time it becomes effective under the Securities Act, contain any untrue statement of a material fact or omit to state any material fact required to be stated therein or necessary to make the statements therein not misleading or (B) the Proxy/Registration Statement will, at the date it is first mailed to the Acquiror Shareholders and at the time of the Acquiror Shareholders' Meeting, contain any untrue statement of a material fact or omit to state any material fact required to be stated therein or necessary in order to make the statements therein, in light of the circumstances under which they are made, not misleading.

(vii) If at any time prior to the Share Exchange Closing the Company or any Acquiror Party becomes aware that any information relating to the Company, any Acquiror Party or any of their respective Subsidiaries, Affiliates, directors or officers set forth in the Proxy/ Registration Statement is required to be amended, so that the Proxy/Registration Statement would not include any untrue statement of a material fact or omit to state any material fact necessary to make the statements therein not misleading, the party which discovers such information shall promptly notify the other parties and an appropriate amendment or supplement describing and/or correcting such information shall be promptly filed with the SEC and, to the extent required by Law, disseminated to the Acquiror Shareholders and Company Shareholders.

(b) Acquiror Shareholder Approval.

(i) After the Proxy/Registration Statement is declared effective under the Securities Act, Acquiror shall (A) within ten (10) Business Days thereof, mail the Proxy/Registration Statement to the Acquiror Shareholders (which shall set forth a record date for, duly call and give notice of a meeting of the Acquiror Shareholders (including any adjournment or postponement thereof, the "Acquiror Shareholders' Meeting") and (B) no later than thirty (30) Business Days after the mailing of the Proxy/Registration Statement to the Acquiror Shareholders, or such other date as may be agreed by Acquiror and the Company, acting reasonably, hold such Acquiror Shareholders' Meeting for the purpose of voting on the Transaction Proposals, obtaining the Acquiror Shareholders' Approval (including if necessary any adjournment or postponement of such meeting for the purpose of soliciting additional proxies in favor of the adoption of this Agreement), and providing Acquiror Shareholders with the opportunity to elect to effect an Acquiror Share Redemption and such other matters as may be mutually agreed by Acquiror and the Company.



(ii) Acquiror will use its reasonable best efforts to (A) solicit from its shareholders proxies in favor of the adoption of the Transaction Proposals, including the Acquiror Shareholders' Approval, and (B) obtain the vote or consent of its shareholders required by and in compliance with all applicable Law, Nasdaq rules and the Acquiror's Governing Documents. Acquiror (A) shall consult with the Company regarding the record date and the date of the Acquiror Shareholders' Meeting, and (B) shall not adjourn or postpone the Acquiror Shareholders' Meeting more than twice (and in that event, for no more than thirty (30) days in the aggregate) without the prior written consent of Company (which consent shall not be unreasonably withheld, conditioned or delayed); provided, that Acquiror shall not be required to adjourn or propose to adjourn the Acquiror Shareholders' Meeting.

(iii) The Proxy/Registration Statement shall include a statement to the effect that the board of directors of Acquiror (the "Acquiror Board") has unanimously recommended that the Acquiror Shareholders vote in favor of the Transaction Proposals at the Acquiror Shareholders' Meeting (such statement, the "Acquiror Board Recommendation") and neither the Acquiror Board nor any committee thereof shall withhold, withdraw, qualify, amend or modify, or publicly propose or resolve to withhold, withdraw, qualify, amend or modify, the Acquiror Board Recommendation.

(c) Company Shareholder Approval.

(i) As promptly as reasonably practicable after the Proxy/Registration Statement is declared effective under the Securities Act, and on a date no later than twenty (20) Business Days following such effectiveness, the Company shall (A) solicit and obtain the Company Shareholder Approval by way of passing a resolution of the Company Shareholders by written means in accordance with the Singapore Companies Act (the "Company Shareholders' Written Resolution"), or (B) in the event the Company is not able to obtain the Company Shareholders' Written Resolution, establish a record date for, duly call, give notice of, convene and hold a meeting of the Company Shareholders (including any adjournment thereof, the "Company Shareholders' Meeting") to be held as promptly as reasonably practicable following the date that the Proxy/Registration Statement is declared effective under the Securities Act, and on a date no later than twenty (20) Business Days following such effectiveness, for the purpose of obtaining the Company Shareholder Approval (including any adjournment of such meeting for the purpose of soliciting additional proxies in favor of this Agreement) and such other matter as may be mutually agreed by Acquiror and the Company. The Company will use its reasonable best efforts to (A) solicit from its shareholders written consents and/or proxies in favor of the Company Shareholder Approval and (B) obtain the Company Shareholder Approval in compliance with all applicable Law and the Company's Governing Documents (including if necessary any adjournment or postponement of such meeting for the purpose of establishing a quorum). The Company (y) shall set the date of the Company Shareholders' Meeting to be no later than twenty (20) Business Days after the Proxy/Registration Statement is declared effective or such other date as may be agreed by Acquiror and the Company, acting reasonably, and (z) shall not adjourn the Company Shareholders' Meeting without the prior written consent of Acquiror (which consent shall not be unreasonably withheld, conditioned or delayed); provided, however, that the Company may adjourn the Company Shareholders' Meeting for a period not exceeding sixteen (16) days without the consent of the Acquiror.

(ii) The Company shall send the Proxy/Registration Statement and the meeting materials to the Company Shareholders which shall seek the Company Shareholder Approval and shall include together with all such meeting materials it sends to the Company Shareholders in connection with the Company Shareholders' Meeting a statement to the effect that the board of directors of the Company (the "Company Board") has unanimously recommended that the Company Shareholders vote in favor of the Company Shareholder Approval (such statement, the "Company Board Recommendation") and neither the Company Board nor any committee thereof shall withhold, withdraw, qualify, amend or modify, or publicly propose or resolve to withhold, withdraw, qualify, amend or modify, the Company Board Recommendation.

Section 10.3. Support of Transaction. Without limiting any covenant contained in Article VIII or Article IX, each Party shall each, (a) use reasonable best efforts to obtain all material consents and approvals of third parties that such Party is required to obtain in order to consummate the Merger and the Share Exchange, and (b) take such other action as may be reasonably necessary or as another Party hereto may reasonably request to satisfy the conditions of Article XI or otherwise to comply with this Agreement and to consummate the transactions contemplated hereby as soon as practicable; provided that the Company shall not be required to act or omit to take any action that would constitute a breach of Section 8.1 and Acquiror Parties shall not be required to act or omit to take any action that would constitute a breach of Section 9.4.

Section 10.4. Public Announcements.

(a) The Parties agree that, at any time on or after the date hereof and continuing until the earlier of the termination of this Agreement in accordance with Section 12.1 or the Share Exchange Closing, no public release, filing or announcement concerning this Agreement or the other Transaction Documents or the transactions contemplated hereby or thereby shall be issued by any party hereto or any of their Representatives or Affiliates without the prior written consent (not be unreasonably withheld, conditioned or delayed) of Acquiror and the Company, except as such release or announcement may be required by applicable Law or the rules or regulations of any securities exchange, in which case the applicable party hereto shall use commercially reasonable efforts to allow the other Parties reasonable time to comment on, and arrange for any required filing with respect to, such release or announcement in advance of such issuance

(b) The Parties shall mutually agree upon and, as promptly as practicable after the execution of this Agreement (but in any event within four (4) Business Days thereafter), issue a press release announcing the execution of this Agreement (the “Signing Press Release”). Promptly after the issuance of the Signing Press Release, Acquiror shall file a current report on Form 8-K (the “Signing Filing”) with the Signing Press Release and a description of this Agreement as required by applicable securities Laws, which shall be subject to the Company’s review, comment and approval prior to filing. The Parties shall mutually agree upon and, as promptly as practicable after the Combination (but in any event within four (4) Business Days thereafter), issue a press release announcing the consummation of the transactions contemplated by this Agreement (the “Closing Press Release”). Promptly after the issuance of the Closing Press Release, PubCo shall file a current report on Form 8-K (the “Closing Filing”) with the Closing Press Release and a description of the Closing as required by all applicable Laws which both of Acquiror and Company shall review, comment upon and approve (which approval shall not be unreasonably withheld, conditioned or delayed) prior to filing. In connection with the preparation of the Signing Press Release, the Signing Filing, the Closing Filing, the Closing Press Release, or any other report, statement, filing notice or application made by or on behalf of a party hereto to any Governmental Authority or other third party in connection with the transactions contemplated hereby, each of the Company on one hand, and the Acquiror Parties on the other, shall, upon request by the other, furnish the other parties with all information concerning themselves, their respective directors, officers and equity holders, and such other matters as may be reasonably necessary or advisable in connection with the transactions contemplated hereby, or any other report, statement, filing, notice or application made by or on behalf of a party hereto to any third party and/ or any Governmental Authority in connection with the transactions contemplated hereby.

Section 10.5. Confidential Information

(a) The Company, PubCo, New SubCo, Merger Sub and the Sellers agree that during the Interim Period and, in the event this Agreement is terminated in accordance with Article XII, for a period of two (2) years after such termination, they shall, and shall cause their respective Representatives to: (i) treat and hold in strict confidence any Acquiror Confidential Information, and will not use for any purpose (except in connection with the consummation of the transactions contemplated by this Agreement or the other Transaction Documents, performing their obligations hereunder or thereunder or enforcing their rights hereunder or thereunder), nor directly or indirectly disclose, distribute, publish, disseminate or otherwise make available to any third party any of the Acquiror Confidential Information without Acquiror’s prior written consent; and (ii) in the event that the Company, PubCo, New SubCo, Merger Sub, any Seller or any of their respective Representatives, during the Interim Period or, in the event that this Agreement is terminated in accordance with Article XII, for a period of two (2) years after such termination, becomes legally compelled to disclose any Acquiror Confidential Information, (A) provide Acquiror to the extent legally permitted with prompt written notice of such requirement so that Acquiror or an Affiliate thereof may seek, at Acquiror’s cost, a protective Order or other remedy or waive compliance with this Section 10.5(a), and (B) in the event that such protective Order or other remedy is not obtained, or Acquiror (including on behalf of any Acquiror Party) waives compliance with this Section 10.5(a), furnish only that portion of such Acquiror Confidential Information which is legally required to be provided as advised by outside counsel and to exercise its commercially reasonable efforts to obtain assurances that confidential treatment will be accorded such Acquiror Confidential Information. In the event that this Agreement is terminated and the transactions contemplated hereby are not consummated, the Company, PubCo, New SubCo, Merger Sub and the Sellers shall, and shall cause their respective Representatives to, promptly destroy any and all copies (in whatever form or medium) of Acquiror Confidential Information and destroy all notes, memoranda, summaries, analyses, compilations and other writings related thereto or based thereon. Notwithstanding the foregoing, the Company and each Signing Seller shall be permitted to disclose Acquiror Confidential Information to any prospective Joining Seller and in connection with any activities contemplated under Section 10.8(a).

(b) Each Acquiror Party hereby agrees that during the Interim Period and, in the event that this Agreement is terminated in accordance with Article XII, for a period of two (2) years after such termination, it shall, and shall cause its Representatives to: (i) treat and hold in strict confidence any Company Confidential Information, and will not use for any purpose (except in connection with the consummation of the transactions contemplated by this Agreement or the other Transaction Documents, performing its obligations hereunder or thereunder or enforcing its rights hereunder or thereunder), nor directly or indirectly disclose, distribute, publish, disseminate or otherwise make available to any third party any of the Company Confidential Information without the Company's prior written consent; and (ii) in the event that Acquiror or any of its Representatives, during the Interim Period or, in the event that this Agreement is terminated in accordance with Article XII, for a period of two (2) years after such termination, becomes legally compelled to disclose any Company Confidential Information, (A) provide the Company to the extent legally permitted with prompt written notice of such requirement so that the Company may seek a protective order or other remedy or waive compliance with this Section 10.5(b) and (B) in the event that such protective order or other remedy is not obtained, or the Company waives compliance with this Section 10.5(b), furnish only that portion of such Company Confidential Information which is legally required to be provided as advised by outside counsel and to exercise its commercially reasonable efforts to obtain assurances that confidential treatment will be accorded such Company Confidential Information. In the event that this Agreement is terminated and the transactions contemplated hereby are not consummated, each Acquiror Party shall, and shall cause its Representatives to, promptly destroy any and all copies (in whatever form or medium) of Company Confidential Information and destroy all notes, memoranda, summaries, analyses, compilations and other writings related thereto or based thereon.

Section 10.6. Transfer Taxes. All transfer, documentary, sales, use, real property, stamp, registration and other similar Taxes, fees and costs (including any associated penalties and interest) ("Transfer Taxes") incurred in connection with this Agreement or the other Transaction Documents by the Company and any Seller shall constitute Company Transaction Expenses.

Section 10.7. Tax Free Reorganization Matters. For U.S. federal income tax purposes (and for purposes of any applicable state or local Tax that follows the U.S. federal income tax treatment), the parties shall prepare and file all Tax Returns consistent with the Intended Tax Treatment, and to the extent required to do so and except to the extent prohibited by applicable Law, shall not take any inconsistent position on any Tax Return, or during the course of any audit, litigation or other proceeding with respect to Taxes, except as otherwise required by a determination within the meaning of Section 1313(a) of the Code. Without limiting the foregoing, PubCo shall ensure that an election is made under Treasury Regulation Section 301.7701-3(c), effective prior to the Merger Closing Date, to treat New SubCo as an entity disregarded from PubCo for U.S. federal income tax purposes.

Section 10.8. Cooperation; Consultation.

(a) Prior to the Share Exchange Closing, each of the Company on the one hand and the Acquiror Parties on the other, shall, and each of them shall cause its respective Representatives to, reasonably cooperate in a timely manner in connection with any financing arrangement (including the Transaction Financing) the parties mutually agree to seek in connection with the transactions contemplated by this Agreement (it being understood and agreed that the consummation of any such financing by the Company and the Acquiror Parties shall be subject to the Company's and the Acquiror Parties' mutual agreement), including (if mutually agreed by the Company and the Acquiror Parties) (i) by providing such information and assistance as the other party may reasonably request, (ii) granting such access to the other party and its Representatives as may be reasonably necessary for their due diligence, and (iii) participating in a reasonable number of meetings, presentations, road shows, drafting sessions and due diligence sessions with respect to such financing efforts (including direct contact between senior management and other Representatives of the Company and its Subsidiaries at reasonable times and locations). All such cooperation, assistance and access shall be granted during normal business hours and shall be granted under conditions that shall not unreasonably interfere with the business and operations of the Company, Acquiror, or their respective auditors.

(b) From the date hereof until the Share Exchange Closing, except to the extent inconsistent with applicable Laws or any confidentiality obligations to third parties, each of Acquiror and the Company shall keep the other reasonably informed from time to time upon reasonable request with respect to the Transaction Financing, including by consulting and cooperating with, and considering in good faith any feedback from, the other or its financial advisors (if any) engaged for the purposes of this Transactions with respect to such matters.

Section 10.9. Transaction Financing. Each of the Acquiror Parties and the Company shall use reasonable best efforts to take, or cause to be taken, all actions and do, or cause to be done, all things necessary, proper or advisable to consummate the transactions contemplated by the Transaction Financing Agreements, including maintaining in effect such agreements and to satisfy on a timely basis all conditions and covenants applicable to it in the Transaction Financing Agreements and otherwise comply with its obligations thereunder to consummate transactions contemplated by the Transaction Financing Agreements at or prior to the Share Exchange Closing.

Section 10.10. Joining Seller The Parties agree that at any time after the date hereof and prior to the Share Exchange Closing, each shareholder of the Company that is not a Signing Seller can become a Joining Seller after the Proxy/Registration Statement having been declared effective by the SEC by duly executing and delivering to the Company and the Acquiror (on behalf of all Acquiror Parties) a joinder agreement in the form attached hereto as Exhibit G (the “BCA Joinder”) to become a party to this Agreement which joinder agreement shall include an agreement by such shareholder of the Company to be bound by the terms and conditions of this Agreement applicable to the Seller and an acknowledgment by such shareholder of the Company that he/she/it has received the Proxy/Registration Statement prospectus with respect to the Transactions. The Company shall use reasonable best efforts to procure that each holder of the Purchased Shares is either a Signing Seller or a Joining Seller. For the avoidance of doubt, in no event shall a shareholder of the Company that is not a Company Insider be a party to this Agreement prior to the SEC’s declaration of effectiveness of the Proxy/Registration Statement. None of the Company and the Acquiror Parties shall acknowledge or accept a BCA Joinder by a shareholder of the Company that is not a Company Insider prior to the effective date of the Proxy/Registration Statement.

Section 10.11. Key Person Agreements.

(a) Each Seller holding 10% or more of the Purchased Shares immediately prior to the Share Exchange Closing agrees that such Seller shall enter into the Non-Disclosure, Non-Competition and Non-Solicitation Agreement; and

(b) Each of the Company and the Acquiror Parties shall procure the execution and delivery of PubCo Employment Agreement by each PubCo executive officers on or prior to the Share Exchange Closing.

Section 10.12. Post-Combination Directors and Officers of PubCo. Each of the Acquiror Parties and the Company shall take all such action within its power as may be necessary or appropriate such that upon the Share Exchange Closing:

(a) the board of directors of PubCo shall consist of seven (7) directors consisting of seven (7) directors designated by the Company prior to the Share Exchange Closing (including two (2) independent directors that are qualified as “independent” under Nasdaq rules) that satisfy Nasdaq Diverse Board Representation Rule provided that the Company shall cause PubCo after the Share Exchange to comply with applicable Nasdaq rule to follow a home country practice; and

(b) the officers of PubCo shall consist of the officers of the Company as of immediately prior to the Share Exchange Closing, who shall serve in such capacity in accordance with the terms of PubCo’s Governing Documents following the Share Exchange Closing, until their respective successors are duly elected or appointed and qualified

Section 10.13. D&O Indemnification and Insurance.

(a) From and after the Share Exchange Closing, each of the Company and Surviving Corporation agrees that it shall, to the fullest extent permitted under applicable Law, indemnify and hold harmless each present and former director and officer of the (x) Company and each of its Subsidiaries (in each case, solely to the extent acting in their capacity as such and to the extent such activities are related to the business of the Company being acquired under this Agreement) (the “Company Indemnified Parties”) and (y) Acquiror and each of its Subsidiaries (the “Acquiror Indemnified Parties” together with the Company Indemnified Parties, the “D&O Indemnified Parties”) against any costs or expenses (including reasonable attorneys’ fees), judgments, fines, losses, claims, damages or liabilities incurred in connection with any Legal Proceeding, whether civil, criminal, administrative or investigative, arising out of or pertaining to matters existing or occurring at or prior to the Share Exchange Closing, whether asserted or claimed prior to, at or after the Share Exchange Closing, to the fullest extent that the Company, Acquiror or their respective Subsidiaries, as the case may be, would have been permitted under applicable Law and each of their respective certificate of incorporation, certificate of formation, bylaws, limited liability company agreement or other organizational documents in effect on the date of this Agreement to indemnify such D&O Indemnified Parties (including the advancing of expenses as incurred to the fullest extent permitted under applicable Law). Without limiting the foregoing, the Surviving Corporation and the Company shall, and shall cause their Subsidiaries to (i) maintain for a period of not less than six (6) years from the Share Exchange Closing provisions in their respective Governing Documents concerning the indemnification and exoneration (including provisions relating to expense advancement) of the Company’s, Acquiror’s and their Subsidiaries’ former and current officers, directors, employees, and agents that are no less favorable to those Persons than the provisions of the Governing Documents of the Company, Acquiror or their respective Subsidiaries, as applicable, in each case, as of the date of this Agreement, and (ii) not amend, repeal or otherwise modify such provisions in any respect that would adversely affect the rights of those Persons thereunder, in each case, except as required by applicable Laws.

(b) For a period of six (6) years from the Share Exchange Closing, the PubCo shall maintain in effect directors’ and officers’ liability insurance covering those Persons who are currently covered by Acquiror’s, the Company’s or their respective Subsidiaries’ directors’ and officers’ liability insurance policies (true, correct and complete copies of which have been heretofore made available to the Company, Acquiror or their respective Representatives, as applicable) on terms not less favorable than the terms of such current insurance coverage, except that in no event shall the PubCo be required to pay an annual premium for such insurance in excess of three hundred percent (300%) of the aggregate annual premium payable by Acquiror or the Company, as applicable, for such insurance policy for the year ended December 31, 2021; provided, that (i) the PubCo may cause coverage to be extended under the current directors’ and officers’ liability insurance by obtaining a six (6) year “tail” policy containing terms not materially less favorable than the terms of such current insurance coverage with respect to claims existing or occurring at or prior to the Share Exchange Closing and (ii) if any claim is asserted or made within such six (6) year period, any insurance required to be maintained under this Section 10.13 shall be continued in respect of such claim until the final disposition thereof.

(c) Notwithstanding anything contained in this Agreement to the contrary, (i) this Section 10.13 shall survive the Share Exchange Closing indefinitely and shall be binding, jointly and severally, on the PubCo, the Surviving Corporation and the Company and all of their respective successors and assigns; and (ii) in the event that the PubCo, the Surviving Corporation or the Company or any of their successors or assigns consolidates with or merges into any other Person and shall not be the continuing or surviving corporation or entity of such consolidation or merger or transfers or conveys all or substantially all of its properties and assets to any Person, then, and in each such case, each of the PubCo, the Surviving Corporation and the Company shall ensure that proper provision shall be made so that the successors and assigns of the PubCo, the Surviving Corporation and the Company, as applicable, shall succeed to the obligations set forth in this Section 10.13.

(d) On the Share Exchange Closing Date, PubCo shall enter into customary indemnification agreements reasonably satisfactory to each of the Company and Acquiror with the directors and officers of PubCo after the consummation of the business combination contemplated hereby, which indemnification agreements shall continue to be effective following the Share Exchange Closing.

(e) The provisions of this Section 10.13: (i) are intended to be for the benefit of, and shall be enforceable by, each Person who is now, or who has been at any time prior to the date of this Agreement or who becomes prior to the Share Exchange Closing, a D&O Indemnified Party, his or her heirs and his or her personal representatives, (ii) shall be binding on the PubCo, the Surviving Corporation and the Company and their respective successors and assigns, (iii) are in addition to, and not in substitution for, any other rights to indemnification or contribution that any such Person may have, whether pursuant to Law, Contract, Governing Documents, or otherwise, and (iv) shall survive the consummation of the business combination and shall not be terminated or modified in such a manner as to adversely affect any D&O Indemnified Party without the prior written consent of such D&O Indemnified Party.



Section 10.14. Antitrust Laws. Without limiting the generality of Section 10.1 and Section 10.3, to the extent required under any Laws that are designed to prohibit, restrict or regulate actions having the purpose or effect of monopolization or restraint of trade ("Antitrust Laws"), each party hereto agrees to make any required filing or application under Antitrust Laws, as applicable, in each case, at such party's sole cost and expense, with respect to the transactions contemplated hereby as promptly as practicable, to supply as promptly as reasonably practicable any additional information and documentary material that may be reasonably requested pursuant to Antitrust Laws and to take all other actions reasonably necessary, proper or advisable to cause the expiration or termination of the applicable waiting periods under Antitrust Laws as soon as practicable, including by requesting early termination of the waiting period provided for under the Antitrust Laws. Each party hereto shall, in connection with its efforts to obtain all requisite approvals and authorizations for the transactions contemplated by this Agreement under any Antitrust Law, use its commercially reasonable efforts to: (i) cooperate in all respects with each other party hereto or its Affiliates in connection with any filing or submission and in connection with any investigation or other inquiry, including any proceeding initiated by a private Person; (ii) keep the other parties reasonably informed of any communication received by such party or its Representatives from, or given by such party or its Representatives to, any Governmental Authority and of any communication received or given in connection with any proceeding by a private Person, in each case regarding any of the transactions contemplated by this Agreement; (iii) permit a Representative of the other Parties and their respective outside counsel to review any communication given by it to, and consult with each other in advance of any meeting or conference with, any Governmental Authority or, in connection with any proceeding by a private Person, with any other Person, and to the extent permitted by such Governmental Authority or other Person, give a Representative or Representatives of the other Parties the opportunity to attend and participate in such meetings and conferences; (iv) in the event a Representative of a party hereto is prohibited from participating in or attending any meetings or conferences, the other parties hereto shall keep such party promptly and reasonably apprised with respect thereto; and (v) use commercially reasonable efforts to cooperate in the filing of any memoranda, white papers, filings, correspondence or other written communications explaining or defending the transactions contemplated hereby, articulating any regulatory or competitive argument, and/or responding to requests or objections made by any Governmental Authority.

Section 10.15. Shareholder Litigation

(a) In the event that any litigation related to this Agreement, any other Transaction Document or the transactions contemplated hereby or thereby is brought, or, to the knowledge of the Company, threatened in writing, against the Company or any of its Subsidiaries or the board of directors of the Company or any of its Subsidiaries by any Company Shareholders prior to the Share Exchange Closing, the Company shall promptly after becoming aware of such litigation notify Acquiror, New SubCo and PubCo of such litigation and keep Acquiror, New SubCo and PubCo reasonably informed with respect to the status thereof; and the Company shall provide Acquiror, New SubCo and PubCo the opportunity to participate in (at its own cost and expense and subject to a customary joint defense agreement), but not control, the defense of any such litigation and shall consider in good faith Acquiror's, New SubCo's and/or PubCo's suggestions with respect to such litigation, and shall not settle any such litigation without the prior written consent of Acquiror, New SubCo and PubCo, such consent not to be unreasonably withheld, conditioned, or delayed.

(b) In the event that any litigation related to this Agreement, any other Transaction Document or the transactions contemplated hereby or thereby is brought, or, to the knowledge of the Acquiror Parties, threatened in writing, against any Acquiror Party or the board of directors of any Acquiror Party by any shareholder of any Acquiror Party prior to the Share Exchange Closing, such Acquiror Party shall promptly after becoming aware of such litigation notify the Company of such litigation and keep the Company reasonably informed with respect to the status thereof; and such Acquiror Party shall provide the Company the opportunity to participate in (at its own cost and expense and subject to a customary joint defense agreement), but not control, the defense of any such litigation and shall consider in good faith the Company's suggestions with respect to such litigation, and shall not settle any such litigation without the prior written consent of the Company, such consent not to be unreasonably withheld, conditioned, or delayed.

## ARTICLE XI

### CONDITIONS TO OBLIGATIONS

Section 11.1. Conditions of each Party's Obligations. The obligations of each party hereto to consummate, or cause to be consummated, the Combination is subject to the satisfaction of the following conditions, any one or more of which may be waived in writing by all of such parties:

(a) the Acquiror Shareholder Approval shall have been obtained;

(b) the Company Shareholder Approval shall have been obtained;

(c) the Proxy/Registration Statement shall have become effective under the Securities Act and no stop order suspending the effectiveness of the Proxy/Registration Statement shall have been issued and no proceedings for that purpose shall have been initiated or threatened by the SEC and not withdrawn;

(d) (i) PubCo's initial listing application as a foreign private issuer with the Nasdaq in connection with the Transactions shall have been conditionally approved and, immediately following the Share Exchange Closing, PubCo shall satisfy any applicable listing requirements of the Nasdaq and PubCo shall not have received any written notice of non-compliance therewith, and (ii) the PubCo Securities to be issued in connection with the Transactions shall have been approved for listing on the Nasdaq, subject to official notice of issuance;

(e) no Governmental Authority shall have enacted, issued, promulgated, enforced or entered any Law (whether temporary, preliminary or permanent) or Governmental Order that is then in effect and which has the effect of making the Merger Closing or the Share Exchange Closing illegal or which otherwise prevents or prohibits consummation of the Merger Closing or the Share Exchange Closing (any of the foregoing, a "restraint"), other than any such restraint that is immaterial, or for which the relevant Governmental Authority does not have jurisdiction over any of the parties hereto with respect to the Transactions;

(f) there shall have been no Company Material Adverse Effect; and

(g) PubCo shall have at least \$5,000,001 of net tangible assets (as determined in accordance with Rule 3a51 1(g)(1) of the Exchange Act) upon the Share Exchange Closing.

Section 11.2. Conditions to Obligations of Acquiror, Merger Sub and PubCo at Merger Closing. The obligations of Acquiror, Merger Sub and PubCo to consummate, or cause to be consummated, the Merger are subject to the satisfaction of the following additional conditions, any one or more of which may be waived in writing by Acquiror:

(a) each of the representations and warranties of the Sellers contained in Article IV and of the Company contained in Article V of this Agreement shall be true and correct in all material respects as of the Merger Closing Date, except with respect to such representations (disregarding any qualifications and exceptions contained therein relating to materiality, material adverse effect or any similar qualification or exception) and warranties which speak as to an earlier date, which representations and warranties (disregarding any qualifications and exceptions contained therein relating to materiality, material adverse effect or any similar qualification or exception) shall be true and correct in all material respects at and as of such date; and

(b) each of the covenants of the Company and the Sellers to be performed as of or prior to the Merger Closing shall have been performed in all material respects.

Section 11.3. Conditions to Obligations of PubCo, New SubCo, the Company and the Sellers at Share Exchange Closing. The obligations of PubCo, New SubCo, the Company and the Sellers to consummate, or cause to be consummated, the Share Exchange is subject to the satisfaction of the following conditions, any one or more of which may be waived in writing by all of such parties:

(a) the Merger Closing shall have occurred;

(b) since the Merger Effective Time, no stop order suspending the effectiveness of the Proxy/Registration Statement shall have been issued and no proceedings for that purpose shall have been initiated or threatened by the SEC and not withdrawn;

(c) since the Merger Effective Time, (i) PubCo shall continue to satisfy any applicable initial and continuing listing requirements of the Nasdaq and PubCo shall not have received any written notice of non-compliance therewith, and (ii) the PubCo Shares to be issued in connection with the Share Exchange shall continue to be approved for listing on the Nasdaq, subject to official notice of issuance; and

(d) since the Merger Effective Time, no Governmental Authority shall have enacted, issued, promulgated, enforced or entered any Law (whether temporary, preliminary or permanent) or Governmental Order that is then in effect and which has the effect of making the Share Exchange Closing illegal or which otherwise prevents or prohibits consummation of the Share Exchange Closing (any of the foregoing, a “share exchange restraint”), other than any such share exchange restraint that is immaterial or for which the relevant Governmental Authority does not have jurisdiction over any of the parties hereto with respect to the Transactions.

Section 11.4. Additional Conditions to the Obligations of PubCo and New SubCo at Share Exchange Closing. The obligations of PubCo and New SubCo to consummate, or cause to be consummated, the Share Exchange is subject to the satisfaction of the following additional conditions, any one or more of which may be waived in writing by PubCo:

(a) each of the representations and warranties of the Sellers contained in Article IV, and of the Company contained in Article V shall be true and correct as of the Share Exchange Closing Date in all material respects, except with respect to such representations and warranties which speak as to an earlier date, which representations and warranties (disregarding any qualifications and exceptions contained therein relating to materiality, material adverse effect or any similar qualification or exception) shall be true and correct in all material respects at and as of such date;

(b) each of the covenants of the Company to be performed as of or prior to the Share Exchange Closing shall have been performed in all material respects;

(c) with respect to each Seller, (i) each of the representations and warranties of such Seller contained in Article IV shall be true and correct as of the Share Exchange Closing Date in all material respects, except with respect to such representations and warranties which speak as to an earlier date, which representations and warranties (disregarding any qualifications and exceptions contained therein relating to materiality, material adverse effect or any similar qualification or exception) shall be true and correct in all material respects at and as of such date, except for, in each case under this Section 11.4(c), inaccuracies or omissions that would not reasonably be expected to have, individually or in the aggregate, a material adverse effect on the ability of such Seller to enter into and perform its obligations under this Agreement; and (ii) each of the covenants of such Seller to be performed as of or prior to the Share Exchange Closing shall have been performed in all material respects; and

(d) all Transaction Documents shall have been executed and delivered by the other parties thereto and been in full force and effect in accordance with the terms thereof as of the Share Exchange Closing

Section 11.5. Additional Conditions to the Obligations of the Company and the Sellers at Share Exchange Closing. The obligations of the Sellers and the Company to consummate, or cause to be consummated, the Share Exchange is subject to the satisfaction of the following additional conditions, any one or more of which may be waived in writing by the Company:

(a) each of the representations and warranties of Acquiror contained in Article VI, and of Acquisition Entities contained in Article VII shall be true and correct as of the Share Exchange Closing Date in all material respects (disregarding any qualifications and exceptions contained therein relating to materiality, material adverse effect or any similar qualification or exception), except with respect to such representations and warranties which speak as to an earlier date, which representations and warranties (disregarding any qualifications and exceptions contained therein relating to materiality, material adverse effect or any similar qualification or exception) shall be true and correct at and as of such date, except for, in each case under this Section 11.5(a), inaccuracies or omissions that would not reasonably be expected to have, individually or in the aggregate, a material adverse effect on the ability of Acquiror or Acquisition Entities to enter into and perform its obligations under this Agreement;

(b) each of the covenants of Acquiror, PubCo and New SubCo to be performed as of or prior to the Share Exchange Closing shall have been performed in all material respects;

(c) the Available Acquiror Cash shall be at least \$20,000,000 immediately prior to or upon the Share Exchange Closing;

(d) the Post-Combination PubCo Charter and PubCo ESOP shall have been duly adopted and shall have remained in full force and effect;

(e) each of the Acquiror Parties shall have delivered to the Company a good standing certificate (or similar documents applicable for the relevant Acquiror Party in its jurisdiction of incorporation) for such Acquiror Party certified as of a date no earlier than twenty (20) days prior to the Share Exchange Closing Date from the proper Governmental Authority of such Acquisition Entity's jurisdiction of organization and from each other jurisdiction in which such Acquisition Entity is qualified to do business as a foreign entity as of the Share Exchange Closing, in each case to the extent that good standing certificates or similar documents are generally available in such jurisdictions;

(f) the Company and PubCo shall have received copies of the executed Transaction Financing Agreements from the investors in connection with the Transaction Financing, in each case in such form satisfactory to the Company.

(g) all Transaction Documents shall have been executed and delivered by the other parties thereto and been in full force and effect in accordance with the terms thereof as of the Share Exchange Closing.

Section 11.6. Frustration of Conditions Notwithstanding anything contained herein to the contrary, no party hereto may rely on the failure of any condition set forth in this Article IX to be satisfied if such failure was caused by the failure of such party hereto or its Affiliates to comply with or perform any of its covenants or obligations set forth in this Agreement. For the avoidance of doubt, the occurrence of any Company Material Adverse Effect shall not be the fault of any party unless such Company Material Adverse Effect is a result of the breach of this Agreement or any other Transaction Document by any particular party hereto, in which case such breaching party cannot rely on the non-satisfaction of Section 11.1(f) to not proceed with the Combination.

## ARTICLE XII

### TERMINATION/EFFECTIVENESS

Section 12.1. Termination. This Agreement may be terminated and the transactions contemplated hereby abandoned:

(a) by mutual written consent of the Company and Acquiror;

(b) by the Company or Acquiror if any Governmental Authority shall have enacted, issued, promulgated, enforced or entered any Law (whether temporary, preliminary or permanent) or Governmental Order that is then in effect and which has the effect of making the Merger Closing or Share Exchange Closing illegal or which otherwise prevents or prohibits consummation of the Merger Closing or Share Exchange Closing, other than any such restraint that is immaterial;

(c) by the Company if the Acquiror Shareholder Approval shall not have been obtained by reason of the failure to obtain the required vote at the Acquiror Shareholders' Meeting duly convened therefor or at any adjournment or postponement thereof; and

(d) prior to the Merger Closing by written notice to the Company from Acquiror if (i) there is any breach of any representation, warranty, covenant or agreement on the part of the Company set forth in this Agreement, such that the conditions specified in Section 11.2(a) or Section 11.2(b) would not be satisfied at the Merger Closing (a "Terminating Company Breach"), except that, if such Terminating Company Breach is curable by the Company through the exercise of its reasonable best efforts, then, for a period of up to thirty (30) days after receipt by the Company of notice from Acquiror of such breach, but only as long as the Company continues to use its reasonable best efforts to cure such Terminating Company Breach (the "Company Cure Period"), such termination shall not be effective, and such termination shall become effective only if (i) the Terminating Company Breach is not cured within the Company Cure Period, or (ii) the Merger Closing has not occurred on or before the Long Stop Date, unless any Acquiror Party is in material breach of this Agreement.

(e) prior to the Merger Closing by written notice to Acquiror from the Company if (i) there is any breach of any representation, warranty, covenant or agreement on the part of any Acquiror Party set forth in this Agreement, such that the conditions specified in Section 11.5(a) and Section 11.5(b) would not be satisfied at the Share Exchange Closing (a "Terminating Acquiror Breach"), except that, if any such Terminating Acquiror Breach is curable by the relevant Acquiror Party, PubCo or New SubCo, as applicable, through the exercise of its reasonable best efforts, then, for a period of up to thirty (30) days after receipt by Acquiror of notice from the Company of such breach, but only as long as the relevant Acquiror Party continues to exercise such reasonable best efforts to cure such Terminating Acquiror Breach (the "Acquiror Cure Period"), such termination shall not be effective, and such termination shall become effective only if (i) the Terminating Acquiror Breach is not cured within the Acquiror Cure Period, or (ii) the Merger Closing has not occurred on or before the Long Stop Date, unless the Company or a Seller is in material breach of this Agreement.

Section 12.2. Effect of Termination. In the event of the termination of this Agreement pursuant to Section 12.1, this Agreement shall forthwith become void and have no effect, without any liability on the part of any party hereto or its respective Affiliates, officers, directors or shareholders, other than liability of the Company, any Acquiror Party or any Seller, as the case may be, for any willful and material breach of this Agreement occurring prior to such termination, except that the provisions of Section 10.4, Section 10.5, Section 10.6, this Section 12.2 and Article XIII shall survive any termination of this Agreement.

### ARTICLE XIII

#### MISCELLANEOUS

Section 13.1. Trust Account Waiver. Each of the Sellers, the Company, PubCo, Merger Sub and New SubCo hereby represents and warrants that it has read Acquiror IPO Prospectus available at [www.sec.report](http://www.sec.report), and understands that Acquiror has established a trust account (the "Trust Account") containing the proceeds of its initial public offering (the "IPO") and the overallotment shares acquired by its underwriters and from certain private placements occurring simultaneously with the IPO (including interest accrued from time to time thereon) for the benefit of Acquiror's public shareholders (including the public shareholders of the overallotment shares acquired by Acquiror's underwriters, the "Public Shareholders"), and that, except as otherwise described in the Acquiror IPO Prospectus, Acquiror may disburse monies from the Trust Account only: (a) to the Public Shareholders with respect to Acquiror Share Redemptions, (b) to the Public Shareholders if Acquiror fails to consummate a Business Combination within 12 months after the closing of the IPO, subject to extension by an amendment to Acquiror's organizational documents, (c) with respect to any interest earned on the amounts held in the Trust Account, amounts necessary to pay for any taxes and up to \$100,000 in dissolution expenses or (d) to Acquiror after or concurrently with the consummation of a Business Combination. Each of the Sellers, the Company, PubCo, Merger Sub and New SubCo hereby agrees on behalf of itself and its Affiliates that, notwithstanding anything to the contrary in this Agreement (other than in Section 9.1), none of the Sellers, the Company, PubCo, Merger Sub and New SubCo or any of their respective Affiliates do now or shall at any time hereafter have any right, title, interest or claim of any kind in or to any monies in the Trust Account or distributions therefrom, or make any claim against the Trust Account (including any distributions therefrom) in connection with any claim that arises as a result of, in connection with, or relating to this Agreement or any other Transaction Document, regardless of whether such claim arises based on contract, tort, equity or any other theory of legal liability under any Transaction Document (collectively, the "Released Claims"). Each of the Sellers, the Company, PubCo, Merger Sub and New SubCo, on behalf of itself and its Affiliates, hereby irrevocably waives any Released Claims Each of the Sellers, the Company, PubCo, Merger Sub and New SubCo or any of their respective Affiliates may have against the Trust Account (including any distributions therefrom) now or in the future and will not seek recourse against the Trust Account (including any distributions therefrom) in connection with any Released Claims (including for an alleged breach of this Agreement or any other Transaction Document). Each of the Sellers, the Company, PubCo, Merger Sub and New SubCo agrees and acknowledges that such irrevocable waiver is material to this Agreement and specifically relied upon by Acquiror and its Affiliates to induce Acquiror to enter into the Transaction Documents, and each of the Sellers, the Company, PubCo, Merger Sub and New SubCo further intends and understands such waiver to be valid, binding and enforceable against the Sellers, the Company, PubCo, Merger Sub and New SubCo and each of their respective Affiliates under applicable Law. To the extent the Sellers, the Company, PubCo, Merger Sub and New SubCo or any of their respective Affiliates commences any action or proceeding based upon, in connection with or relating to any Released Claim, which action or proceeding seeks, in whole or in part, monetary relief against Acquiror or its Representatives, each of the Sellers, the Company, PubCo, Merger Sub and New SubCo hereby acknowledges and agrees that each such Sellers, the Company's, PubCo's, Merger Sub's, New SubCo's and each of their respective Affiliates' sole remedy shall be against funds held outside of the Trust Account and that such claim shall not permit the Sellers, the Company, PubCo, Merger Sub and New SubCo or any of their respective Affiliates (or any person claiming on any of their behalves or in lieu of any of them) to have any claim against the Trust Account (including any distributions therefrom) or any amounts contained therein. In the event the Sellers, the Company, PubCo, Merger Sub and New SubCo or any of their respective Affiliates commences any action or proceeding based upon, in connection with or relating to any Released Claim, which proceeding seeks, in whole or in part, relief against the Trust Account (including any distributions therefrom) or the Public Shareholders, whether in the form of money damages or injunctive relief or otherwise, Acquiror and its Representatives, as applicable, shall be entitled to recover Sellers, the Company, PubCo, Merger Sub and New SubCo and their respective Affiliates the associated legal fees and costs in connection with any such action, in the event Acquiror or its Representatives, as applicable, prevails in such action or proceeding.

Section 13.2. Waiver. Any party to this Agreement may, at any time prior to the Share Exchange Closing, by action taken by its board of directors or other officers or Persons thereunto duly authorized, (a) extend the time for the performance of the obligations or acts of the other parties hereto, (b) waive any inaccuracies in the representations and warranties (of another party hereto) that are contained in this Agreement or (c) waive compliance by the other parties hereto with any of the agreements or conditions contained in this Agreement, but such extension or waiver shall be valid only if set forth in an instrument in writing signed by the party granting such extension or waiver.

Section 13.3. Notices. All general notices, demands or other communications required or permitted to be given or made hereunder shall be in writing and delivered personally or sent by courier or sent by registered post or sent by electronic mail to the intended recipient thereof at its address or at its email address set out below (or to such other address or email address as a party may from time to time notify the other parties). Any such notice, demand or communication shall be deemed to have been duly served (a) if given personally or sent by courier, upon delivery during normal business hours at the location of delivery or, if later, then on the next Business Day after the day of delivery; (b) if sent by electronic mail during normal business hours at the location of delivery, immediately, or, if later, then on the next Business Day after the day of delivery; (c) the third Business Day following the day sent by reputable international overnight courier (with written confirmation of receipt); and (d) if sent by registered post, five (5) days after posting. The initial addresses and email addresses of the parties for the purpose of this Agreement are:

- (a) If to Acquiror, Merger Sub, PubCo (prior to the Combination) or New SubCo (prior to the Combination) to:

Prime Number Acquisition I Corp.  
1129 Northern Blvd., Suite 404  
Manhasset, NY 11030  
Attention: Dongfeng Wang  
Email: 161160@gmail.com

with copies to (which shall not constitute notice):

Robinson & Cole LLP  
666 Third Avenue, 20<sup>th</sup> Floor  
New York, NY 10017  
Attention: Arila E. Zhou  
Email: azhou@rc.com

- (b) If to PubCo (after the Combination) or New SubCo (after the Combination), to:

Noco-Noco Pte. Ltd.  
#04-06 SGX Centre 2, Singapore  
Attention: Kenneth Lim  
Email: kenneth.lim@3dom.co.jp



(c) If to the Company or the Sellers, to:

Noco-Noco Pte. Ltd.  
#04-06 SGX Centre 2, Singapore  
Attention: Kenneth Lim  
Email: kenneth.lim@3dom.co.jp

with copies to (which shall not constitute notice):

Sidley Austin LLP  
39/F, Two Int'l Finance Centre  
Central, Hong Kong  
Attention: Raymond Oh  
Email: roh@sidley.com

or to such other address or addresses as the parties may from time to time designate in writing. Copies delivered solely to outside counsel shall not constitute notice.

Section 13.4. Assignment. Subject to Section 10.10, no party hereto shall assign this Agreement or any part hereof without the prior written consent of the other parties and any such transfer without the prior written consent shall be void. Subject to the foregoing, this Agreement shall be binding upon and inure to the benefit of the parties hereto and their respective permitted successors and assigns.

Section 13.5. Rights of Third Parties. Nothing expressed or implied in this Agreement is intended or shall be construed to confer upon or give any Person, other than the parties hereto, any right or remedies under or by reason of this Agreement; provided, that (a) the D&O Indemnified Parties may enforce Section 10.13; and (b) the Non-Recourse Parties may enforce Section 13.16.

Section 13.6. Expenses. Except as otherwise set forth in this Agreement, each party hereto shall be responsible for and pay its own expenses incurred in connection with this Agreement and the transactions contemplated hereby, including all fees of its legal counsel, financial advisers and accountants; provided, that if the Share Exchange Closing shall occur, the Company shall pay or cause to be paid the Acquiror Transaction Expenses and the Company Transaction Expenses in accordance with Section 3.5.

Section 13.7. Headings; Counterparts. The headings in this Agreement are for convenience only and shall not be considered a part of or affect the construction or interpretation of any provision of this Agreement. This Agreement may be executed in two or more counterparts, each of which shall be deemed an original, but all of which together shall constitute one and the same instrument.

Section 13.8. Electronic Execution of the Agreement and Certain Other Documents. The words “execution,” “execute,” “signed,” “signature,” and words of like import in or related to this Agreement or any Transaction Document (including, without limitation, any related amendments, waivers and consents) shall be deemed to include electronic signatures, the electronic matching of assignment terms and contract formations on electronic platforms complying with applicable law, or the keeping of records in electronic form, each of which shall be of the same legal effect, validity or enforceability as a manually executed signature or the use of a paper-based recordkeeping system, as the case may be, to the extent and as provided for in any applicable law, including the Federal Electronic Signatures in Global and National Commerce Act, the Delaware Uniform Electronic Transactions Act, the New York State Electronic Signatures and Records Act, or any other similar state laws based on the Uniform Electronic Transactions Act.

Section 13.9. Company Disclosure Letter. The Company Disclosure Letter (including any section thereof) referenced herein are a part of this Agreement as if fully set forth herein. All references herein to the Company Disclosure Letter (including any section thereof) shall be deemed references to such parts of this Agreement, unless the context shall otherwise require. Any disclosure made in the Company Disclosure Letter, or any section thereof, with reference to any section of this Agreement or section of the Company Disclosure Letter shall be deemed to be a disclosure with respect to such other applicable sections of this Agreement or sections of the Company Disclosure Letter only if it is reasonably apparent on the face of such disclosure that such disclosure is responsive to such other section of this Agreement or section of the applicable Disclosure Letter. Certain information set forth in the Company Disclosure Letters is included solely for informational purposes and may not be required to be disclosed pursuant to this Agreement. The disclosure of any information shall not be deemed to constitute an acknowledgment that such information is required to be disclosed in connection with the representations and warranties made in this Agreement, nor shall such information be deemed to establish a standard of materiality.

Section 13.10. Entire Agreement. This Agreement (together with the Company Disclosure Letter) and the other Transaction Documents constitute the entire agreement among the parties to this Agreement relating to the transactions contemplated hereby and supersede any other agreements, whether written or oral, that may have been made or entered into by or among any of the parties hereto or any of their respective Subsidiaries relating to the transactions contemplated hereby. No representations, warranties, covenants, understandings, agreements, oral or otherwise, relating to the transactions contemplated hereby exist between such parties except as expressly set forth in this Agreement and the other Transaction Documents.

Section 13.11. Amendments. This Agreement may be amended or modified in whole or in part, only by a duly authorized agreement in writing executed in the same manner as this Agreement and which makes reference to this Agreement; provided, that after the Company Shareholder Approval or the Acquiror Shareholder Approval has been obtained, there shall be no amendment or waiver that by applicable Law requires further approval by the Company Shareholders or the Acquiror Shareholders, respectively, without such approval having been obtained.

Section 13.12. Severability. If any provision of this Agreement is held invalid or unenforceable by any court of competent jurisdiction, the other provisions of this Agreement shall remain in full force and effect. The parties further agree that if any provision contained herein is, to any extent, held invalid or unenforceable in any respect under the Laws governing this Agreement, they shall take any actions necessary to render the remaining provisions of this Agreement valid and enforceable to the fullest extent permitted by Law and, to the extent necessary, shall amend or otherwise modify this Agreement to replace any provision contained herein that is held invalid or unenforceable with a valid and enforceable provision giving effect to the intent of the parties.

Section 13.13. Governing Law. This Agreement, and all claims or causes of action based upon, arising out of, or related to this Agreement or the transactions contemplated hereby, shall be governed by, and construed in accordance with, the Laws of the State of Delaware, without giving effect to principles or rules of conflict of Laws to the extent such principles or rules would require or permit the application of Laws of another jurisdiction.

Section 13.14. Jurisdiction; Waiver of Jury Trial.

(a) Any proceeding or Action based upon, arising out of or related to this Agreement or the transactions contemplated hereby must be brought in the Court of Chancery of the State of Delaware (or, to the extent such court does not have subject matter jurisdiction, the Superior Court of the State of Delaware), or, if it has or can acquire jurisdiction, in the United States District Court for the District of Delaware, and each of the parties irrevocably (i) submits to the exclusive jurisdiction of each such court in any such proceeding or Action, (ii) waives any objection it may now or hereafter have to personal jurisdiction, venue or to convenience of forum, (iii) agrees that all claims in respect of the proceeding or Action shall be heard and determined only in any such court, and (iv) agrees not to bring any proceeding or Action arising out of or relating to this Agreement or the transactions contemplated hereby in any other court. Nothing herein contained shall be deemed to affect the right of any party to serve process in any manner permitted by Law or to commence Legal Proceedings or otherwise proceed against any other party in any other jurisdiction, in each case, to enforce judgments obtained in any Action, suit or proceeding brought pursuant to this Section 13.14.

(b) EACH PARTY HERETO ACKNOWLEDGES AND AGREES THAT ANY CONTROVERSY WHICH MAY ARISE UNDER THIS AGREEMENT AND THE TRANSACTIONS CONTEMPLATED HEREBY IS LIKELY TO INVOLVE COMPLICATED AND DIFFICULT ISSUES, AND THEREFORE EACH SUCH PARTY HEREBY IRREVOCABLY, UNCONDITIONALLY AND VOLUNTARILY WAIVES ANY RIGHT SUCH PARTY MAY HAVE TO A TRIAL BY JURY IN RESPECT OF ANY ACTION, SUIT OR PROCEEDING DIRECTLY OR INDIRECTLY ARISING OUT OF OR RELATING TO THIS AGREEMENT OR ANY OF THE TRANSACTIONS CONTEMPLATED HEREBY.

Section 13.15. Enforcement. The parties hereto agree that irreparable damage could occur in the event that any of the provisions of this Agreement were not performed in accordance with their specific terms or were otherwise breached. It is accordingly agreed that the parties shall be entitled to seek an injunction or injunctions to prevent breaches of this Agreement and to specific enforcement of the terms and provisions of this Agreement, in addition to any other remedy to which any party is entitled at law or in equity. In the event that any Action shall be brought in equity to enforce the provisions of this Agreement, no party shall allege, and each party hereby waives the defense, that there is an adequate remedy at law, and each party agrees to waive any requirement for the securing or posting of any bond in connection therewith.

Section 13.16. Non-Recourse. Except in the case of claims against a Person in respect of such Person's fraud:

(a) this Agreement may only be enforced against, and any claim or cause of action based upon, arising out of, or related to this Agreement or the transactions contemplated hereby may only be brought against, the Persons that are expressly named as parties hereto and then only with respect to the specific obligations set forth herein with respect to such party; and

(b) except to the extent a party hereto (and then only to the extent of the specific obligations undertaken by such party hereto), (i) no past, present or future director, commissioner, officer, employee, incorporator, member, partner, shareholder, Representative or Affiliate of the the Sellers, the Company, PubCo, Merger Sub and New SubCo and (ii) no past, present or future director, commissioner, officer, employee, incorporator, member, partner, shareholder, Representative or Affiliate of any of the foregoing (collectively, the "Non-Recourse Parties") shall have any liability (whether in Contract, tort, equity or otherwise) for any one or more of the representations, warranties, covenants, agreements or other obligations or liabilities of any one or more of the Parties under this Agreement for any claim based on, arising out of, or related to this Agreement or the transactions contemplated hereby.

Section 13.17. Non-Survival of Representations, Warranties and Covenants. Except (x) as otherwise contemplated by Section 12.2 or (y) in the case of claims against a Person in respect of such Person's actual fraud, none of the representations, warranties, covenants, obligations or other agreements in this Agreement or in any certificate, statement or instrument delivered pursuant to this Agreement, including any rights arising out of any breach of such representations, warranties, covenants, obligations, agreements and other provisions, shall survive the Share Exchange Closing and each such representation, warranty, covenant, obligation, agreement and provision shall terminate and expire upon the occurrence of the Share Exchange Closing (and there shall be no liability after the Share Exchange Closing in respect thereof), except for (a) those covenants and agreements contained herein that by their terms expressly apply in whole or in part after the Share Exchange Closing and then only with respect to any breaches occurring after the Share Exchange Closing and (b) this Article XIII.

Section 13.18. New SubCo. New SubCo shall become a party to this Agreement by executing and delivering an additional counterpart signature page to this Agreement, and thereafter shall be deemed an “Acquisition Entity” for all purposes hereunder. No action or consent by the Company, the Sellers or any other Acquiror Party shall be required for such joinder to this Agreement by New SubCo. By delivering a counterpart signature page to this Agreement, New SubCo agrees and consents to be bound by the rights and obligations as “New SubCo” hereunder.

Section 13.19. PubCo. PubCo shall become a party to this Agreement by executing and delivering an additional counterpart signature page to this Agreement, and thereafter shall be deemed an “Acquisition Entity” for all purposes hereunder. No action or consent by the Company, the Sellers or any other Acquiror Party shall be required for such joinder to this Agreement by PubCo. By delivering a counterpart signature page to this Agreement, PubCo agrees and consents to be bound by the rights and obligations as “PubCo” hereunder.

[Remainder of page intentionally left blank]

IN WITNESS WHEREOF the parties have hereunto caused this Agreement to be duly executed as of the date first above written.

Acquiror

**Prime Number Acquisition I Corp.**

By: /s/ Dongfeng Wang  
Name: Dongfeng Wang  
Title: CEO and Chairman

Merger Sub

**Prime Number Merger Sub Inc.**

By: /s/ Dongfeng Wang  
Name: Dongfeng Wang  
Title: CEO and Chairman

[SIGNATURE PAGE]

---

IN WITNESS WHEREOF the undersigned has duly executed this Agreement as PubCo.

PubCo

**PRIME NUMBER HOLDING LIMITED**

By: /s/ Dongfeng Wang  
Name: Dongfeng Wang  
Title: Director

Date: 2/3/2023

[SIGNATURE PAGE]

---

IN WITNESS WHEREOF the undersigned has duly executed this Agreement as New SubCo.

New SubCo

**PRIME NUMBER NEW SUB PTE. LTD.**

By: /s/ Weixiong (Jeff) Cheong  
Name: Weixiong (Jeff) Cheong  
Title: Director

Date: 2/3/2023

[SIGNATURE PAGE]

---



IN WITNESS WHEREOF the parties have hereunto caused this Agreement to be duly executed as of the date first above written.

Company

**NOCO-NOCO PTE. LTD.**

By: /s/ Masataka Matsumura  
Name: Masataka Matsumura  
Title: Director and CEO

[SIGNATURE PAGE]

---

IN WITNESS WHEREOF the parties have hereunto caused this Agreement to be duly executed as of the date first above written.

Seller

**3DOM ALLIANCE INC.**

By: /s/ Masataka Matsumura  
Name: Masataka Matsumura  
Title: Director and CEO

[SIGNATURE PAGE]

---

IN WITNESS WHEREOF the parties have hereunto caused this Agreement to be duly executed as of the date first above written.

Seller

**FUTURE SCIENCE RESEARCH INC.**

By: /s/ Masato Tomitaku

Name: Masato Tomitaku

Title: CEO

[SIGNATURE PAGE]

---

## Annex I

## Allocation Schedule

As of the date of this Agreement:

<b>Seller Name</b>	<b>No. of Purchased Shares</b>	<b>Pro Rata Portion*</b>	<b>No. of PubCo Ordinary Shares allocated</b>
3DOM ALLIANCE INC.	237,908	73.13%	to be calculated
FUTURE SCIENCE RESEARCH INC.	27,438	8.43%	to be calculated

\*assuming all holders of the Company Ordinary Shares are Sellers.

---

**Companies Act (Revised)  
Company Limited by Shares**

---

**AMENDED AND RESTATED  
MEMORANDUM OF ASSOCIATION  
OF  
NOCO-NOCO INC.**

---

(Adopted by special resolution passed on [●] 2023)



**Companies Act (Revised)**

**Company Limited by Shares**

**Amended and Restated Memorandum of Association**

**of**

**noco-noco Inc.**

(Adopted by special resolution passed on [●] 2023)

- 1 The name of the Company is **noco-noco Inc.**
  - 2 The Company's registered office will be situated at the office of Ogier Global (Cayman) Limited, 89 Nexus Way, Camana Bay, Grand Cayman, KY1-9009, Cayman Islands or at such other place in the Cayman Islands as the directors may at any time decide.
  - 3 The Company's objects are unrestricted. As provided by section 7(4) of the Companies Act (Revised), the Company has full power and authority to carry out any object not prohibited by any law of the Cayman Islands.
  - 4 The Company has unrestricted corporate capacity. Without limitation to the foregoing, as provided by section 27 (2) of the Companies Act (Revised), the Company has and is capable of exercising all the functions of a natural person of full capacity irrespective of any question of corporate benefit.
  - 5 Nothing in any of the preceding paragraphs permits the Company to carry on any of the following businesses without being duly licensed, namely:
    - (a) the business of a bank or trust company without being licensed in that behalf under the Banks and Trust Companies Act (Revised); or
    - (b) insurance business from within the Cayman Islands or the business of an insurance manager, agent, sub-agent or broker without being licensed in that behalf under the Insurance Act (Revised); or
    - (c) the business of company management without being licensed in that behalf under the Companies Management Act (Revised).
  - 6 Unless licensed to do so, the Company will not trade in the Cayman Islands with any person, firm or corporation except in furtherance of its business carried on outside the Cayman Islands. Despite this, the Company may effect and conclude contracts in the Cayman Islands and exercise in the Cayman Islands any of its powers necessary for the carrying on of its business outside the Cayman Islands.
-

- 7 The Company is a company limited by shares and accordingly the liability of each member is limited to the amount (if any) unpaid on that member's shares.
- 8 The share capital of the Company is USD50,000 divided into 500,000,000 Ordinary Shares of par value USD0.0001 each. However, subject to the Companies Act (Revised) and the Company's articles of association, the Company has power to do any one or more of the following:
- (a) to redeem or repurchase any of its shares; and
  - (b) to increase or reduce its capital; and
  - (c) to issue any part of its capital (whether original, redeemed, increased or reduced):
    - (i) with or without any preferential, deferred, qualified or special rights, privileges or conditions; or
    - (ii) subject to any limitations or restrictionsand unless the condition of issue expressly declares otherwise, every issue of shares (whether declared to be ordinary, preference or otherwise) is subject to this power; or
  - (d) to alter any of those rights, privileges, conditions, limitations or restrictions.
- 9 The Company has power to register by way of continuation as a body corporate limited by shares under the laws of any jurisdiction outside the Cayman Islands and to be deregistered in the Cayman Islands.
-

**Companies Act (Revised)**  
**Company Limited By Shares**

---

**AMENDED AND RESTATED  
ARTICLES OF ASSOCIATION  
OF  
NOCO-NOCO INC.**

---

(Adopted by special resolution passed on [●] 2023)





## Contents

1	Definitions, interpretation and exclusion of Table A	B-1
2	Shares	B-5
3	Share certificates	B-9
4	Lien on Shares	B-10
5	Calls on Shares and forfeiture	B-12
6	Transfer of Shares	B-15
7	Transmission of Shares	B-16
8	Alteration of capital	B-17
9	Redemption and purchase of own Shares	B-18
10	Meetings of Members	B-20
11	Proceedings at meetings of Members	B-22
12	Voting rights of Members	B-26
13	Number of Directors	B-30
14	Appointment, disqualification and removal of Directors	B-30
15	Alternate Directors	B-33
16	Powers of Directors	B-34
17	Delegation of powers	B-37
18	Meetings of Directors	B-39
19	Permissible Directors' interests and disclosure	B-41
20	Minutes	B-42
21	Accounts and audit; Financial year	B-43
22	Record dates	B-43
23	Dividends	B-44
24	Capitalisation of profits	B-46
25	Share Premium Account	B-47
26	Seal	B-48
27	Indemnity	B-49
28	Notices	B-50
29	Authentication of Electronic Records	B-54
30	Transfer by way of continuation	B-55
31	Winding up	B-56
32	Amendment of Memorandum and Articles	B-56
33	Mergers and Consolidations	B-57
34	Certain Tax Filings	B-57

---

**Companies Act (Revised)**  
**Company Limited by Shares**  
**Amended and Restated Articles of Association**  
**of**

**noco-noco Inc.** (Adopted by special resolution passed on [●] 2023)

**1 Definitions, interpretation and exclusion of Table A**

**Definitions**

1.1 In these Articles, the following definitions apply:

**Act** means the Companies Act (Revised) of the Cayman Islands, including any statutory modification or re-enactment thereof for the time being in force;

**Articles** means, as appropriate:

- (a) these articles of association as amended from time to time; or
- (b) two or more particular articles of these Articles;

and **Article** refers to a particular article of these Articles;

**Auditors** means the auditor or auditors for the time being of the Company;

**Board** means the board of Directors from time to time;

**Business Day** means a day, other than a day on which banking institutions or trust companies are authorised or obligated by law to close in New York City, Singapore or Japan, when banks in Grand Cayman, the Cayman Islands are open for the transaction of normal banking business and for the avoidance of doubt, shall not include a Saturday, Sunday or public holiday in the Cayman Islands;

**Cayman Islands** means the British Overseas Territory of the Cayman Islands;

**Clear Days**, in relation to a period of notice, means that period excluding:

- (a) the day when the notice is given or deemed to be given; and
- (b) the day for which it is given or on which it is to take effect;

**Clearing House** means a clearing house recognised by the laws of the jurisdiction in which the Shares (or depositary receipts therefor) are listed or quoted on a stock exchange or interdealer quotation system in such jurisdiction.

**Commission** means Securities and Exchange Commission of the United States of America or other federal agency for the time being administering the U.S. Securities Act;

**Company** means the above-named company;

**Default Rate** means ten per cent per annum;

**Designated Stock Exchanges** means the [Nasdaq Capital Market]<sup>1</sup> in the United States of America for so long as the Company's Shares are there listed and any other stock exchange on which the Company's Shares are listed for trading;

**Designated Stock Exchange Rules** means the relevant code, rules and regulations, as amended, from time to time, applicable as a result of the original and continued listing of any Shares on the Designated Stock Exchanges;

**Directors** means the directors for the time being of the Company and the expression Director shall be construed accordingly;

**Electronic** has the meaning given to that term in the Electronic Transactions Act (Revised) of the Cayman Islands;

**Electronic Record** has the meaning given to that term in the Electronic Transactions Act (Revised) of the Cayman Islands;

**Electronic Signature** has the meaning given to that term in the Electronic Transactions Act (Revised) of the Cayman Islands;

**Fully Paid Up** means:

- (a) in relation to a Share with par value, means that the par value for that Share and any premium payable in respect of the issue of that Share, has been fully paid or credited as paid in money or money's worth; and
- (b) in relation to a Share without par value, means that the agreed issue price for that Share has been fully paid or credited as paid in money or money's worth;

**General Meeting** means a general meeting of the Company duly constituted in accordance with the Articles;

**Independent Director** means a Director who is an independent director as defined in the Designated Stock Exchange Rules as determined by the Board;

**Member** means any person or persons entered on the register of Members from time to time as the holder of a Share;

---

<sup>1</sup> NTD: To confirm before adoption.

**Memorandum** means the memorandum of association of the Company as amended from time to time;

**month** means a calendar month;

**Officer** means a person appointed to hold an office in the Company including a Director, alternate Director or liquidator and excluding the Secretary;

**Ordinary Resolution** means a resolution of a General Meeting passed by a simple majority of Members who (being entitled to do so) vote in person or by proxy at that meeting. The expression includes a unanimous written resolution;

**Ordinary Share** means an ordinary share in the capital of the Company;

**Partly Paid Up** means:

- (a) in relation to a Share with par value, that the par value for that Share and any premium payable in respect of the issue of that Share, has not been fully paid or credited as paid in money or money's worth; and
- (b) in relation to a Share without par value, means that the agreed issue price for that Share has not been fully paid or credited as paid in money or money's worth;

**Secretary** means a person appointed to perform the duties of the secretary of the Company, including a joint, assistant or deputy secretary;

**Share** means a share in the capital of the Company and the expression:

- (a) includes stock (except where a distinction between shares and stock is expressed or implied); and
- (b) where the context permits, also includes a fraction of a Share;

**Special Resolution** means a resolution of a General Meeting or a resolution of a meeting of the holders of any class of Shares in a class meeting duly constituted in accordance with the Articles in each case passed by a majority of not less than two-thirds of Members who (being entitled to do so) vote in person or by proxy at that meeting. The expression includes a unanimous written resolution;

**Treasury Shares** means Shares held in treasury pursuant to the Act and Article 2.12; and

**U.S. Securities Act** means the Securities Act of 1933 of the United States of America, as amended, or any similar federal statute and the rules and regulations of the Commission thereunder, all as the same shall be in effect at the time.

## Interpretation

1.2 In the interpretation of these Articles, the following provisions apply unless the context otherwise requires:

- (a) A reference in these Articles to a statute is a reference to a statute of the Cayman Islands as known by its short title, and includes:
  - (i) any statutory modification, amendment or re-enactment; and
  - (ii) any subordinate legislation or regulations issued under that statute.

Without limitation to the preceding sentence, a reference to a revised Act of the Cayman Islands is taken to be a reference to the revision of that Act in force from time to time as amended from time to time.

- (b) Headings are inserted for convenience only and do not affect the interpretation of these Articles, unless there is ambiguity.
- (c) If a day on which any act, matter or thing is to be done under these Articles is not a Business Day, the act, matter or thing must be done on the next Business Day.
- (d) A word which denotes the singular also denotes the plural, a word which denotes the plural also denotes the singular, and a reference to any gender also denotes the other genders.
- (e) A reference to a **person** includes, as appropriate, a company, trust, partnership, joint venture, association, body corporate or government agency.
- (f) Where a word or phrase is given a defined meaning another part of speech or grammatical form in respect to that word or phrase has a corresponding meaning.
- (g) All references to time are to be calculated by reference to time in the place where the Company's registered office is located.
- (h) The words **written** and **in writing** include all modes of representing or reproducing words in a visible form, but do not include an Electronic Record where the distinction between a document in writing and an Electronic Record is expressed or implied.
- (i) The words **including**, **include** and **in particular** or any similar expression are to be construed without limitation.

1.3 The headings in these Articles are intended for convenience only and shall not affect the interpretation of these Articles.

## **Exclusion of Table A Articles**

1.4 The regulations contained in Table A in the First Schedule of the Act and any other regulations contained in any statute or subordinate legislation are expressly excluded and do not apply to the Company.

## **2 Shares**

### **Power to issue Shares and options, with or without special rights**

2.1 Subject to the provisions of the Act and these Articles about the redemption and purchase of the Shares, the Directors have general and unconditional authority to allot (with or without confirming rights of renunciation), issue, grant options over or otherwise deal with any unissued Shares to such persons, at such times and on such terms and conditions as they may decide. No Share may be issued at a discount except in accordance with the provisions of the Act.

2.2 Without limitation to the preceding Article, the Directors may so deal with the unissued Shares:

- (a) either at a premium or at par; or
- (b) with or without preferred, deferred or other special rights or restrictions, whether in regard to dividend, voting, return of capital or otherwise.

2.3 Without limitation to the two preceding Articles, the Directors may refuse to accept any application for Shares, and may accept any application in whole or in part, for any reason or for no reason.

2.4 The Company may issue rights, options, warrants or convertible securities or securities of similar nature conferring the right upon the holders thereof to subscribe for, purchase or receive any class of Shares or other securities in the Company at such times and on such terms and conditions as the Directors may decide.

2.5 The Company may issue units of securities in the Company, which may be comprised of Shares, rights, options, warrants or convertible securities or securities of similar nature conferring the right upon the holders thereof to subscribe for, purchase or receive any class of Shares or other securities in the Company, on such terms and conditions as the Directors may decide.

2.6 Subject to these Articles, each Share in the Company confers upon the Member:

- (a) the right to one vote at a meeting of the Members of the Company or on any resolution of Members;
- (b) a pro rata right in any dividend paid by the Company; and

- (c) a pro rata right in the distribution of the surplus assets of the Company on its liquidation.

**Power to issue fractions of a Share**

- 2.7 Subject to the Act, the Company may, but shall not otherwise be obliged to, issue fractions of a Share of any class or round up or down fractional holdings of Shares to its nearest whole number. A fraction of a Share shall be subject to and carry the corresponding fraction of liabilities (whether with respect to calls or otherwise), limitations, preferences, privileges, qualifications, restrictions, rights and other attributes of a Share of that class of Shares.

**Power to pay commissions and brokerage fees**

- 2.8 The Company may pay a commission to any person in consideration of that person:
- (a) subscribing or agreeing to subscribe, whether absolutely or conditionally; or
  - (b) procuring or agreeing to procure subscriptions, whether absolute or conditional,
- for any Shares. That commission may be satisfied by the payment of cash or the allotment of Fully Paid Up or Partly Paid Up Shares or partly in one way and partly in another.
- 2.9 The Company may employ a broker in the issue of its capital and pay such person any proper commission or brokerage.

**Trusts not recognised**

- 2.10 Except as required by Law:
- (a) the Company shall not be bound by or compelled to recognise in any way (even when notified) any equitable, contingent, future or partial interest in any Share, or (except only as is otherwise provided by the Articles) any other rights in respect of any Share other than an absolute right to the entirety thereof in the holder; and
  - (b) no person other than the Member shall be recognised by the Company as having any right in a Share.

**Security interests**

- 2.11 Notwithstanding the preceding Article, the Company may (but shall not be obliged to) recognise a security interest of which it has actual notice over Shares. The Company shall not be treated as having recognised any such security interest unless it has so agreed in writing with the secured party.

**Power to vary class rights**

- 2.12 If the share capital is divided into different classes of Shares then, unless the terms on which a class of Shares was issued state otherwise, the rights attaching to a class of Shares may only be varied if one of the following applies:
- (a) the Members holding not less than two-thirds of the issued Shares of that class consent in writing to the variation; or
  - (b) the variation is made with the sanction of a Special Resolution passed at a separate General Meeting of the Members holding the issued Shares of that class.
- 2.13 For the purpose of Article 2.12(b), all the provisions of these Articles relating to General Meetings apply, mutatis mutandis, to every such separate meeting except that:
- (a) the necessary quorum shall be one or more persons holding, or representing by proxy, not less than one third of the issued Shares of the class; and
  - (b) any Member holding issued Shares of the class, present in person or by proxy or, in the case of a corporate Member, by its duly authorised representative, may demand a poll.

**Effect of new Share issue on existing class rights**

- 2.14 Unless the terms on which a class of Shares was issued state otherwise, the rights conferred on the Member holding Shares of any class shall not be deemed to be varied by the creation or issue of further Shares ranking *pari passu* with the existing Shares of that class.

**Capital contributions without issue of further Shares**

- 2.15 With the consent of a Member, the Directors may accept a voluntary contribution to the capital of the Company from that Member without issuing Shares in consideration for that contribution. In that event, the contribution shall be dealt with in the following manner:
- (a) It shall be treated as if it were a share premium.
  - (b) Unless the Member agrees otherwise:
    - (i) if the Member holds Shares in a single class of Shares - it shall be credited to the share premium account for that class of Shares;
    - (ii) if the Member holds Shares of more than one class - it shall be credited rateably to the share premium accounts for those classes of Shares (in the proportion that the sum of the issue prices for each class of Shares that the Member holds bears to the total issue prices for all classes of Shares that the Member holds).



- (c) It shall be subject to the provisions of the Act and these Articles applicable to share premiums.

**No bearer Shares or warrants**

2.16 The Company shall not issue Shares or warrants to bearers.

**Treasury Shares**

2.17 Shares that the Company purchases, redeems or acquires by way of surrender in accordance with the Act shall be held as Treasury Shares and not treated as cancelled if:

- (a) the Directors so determine prior to the purchase, redemption or surrender of those shares; and
- (b) the relevant provisions of the Memorandum and Articles and the Act are otherwise complied with.

**Rights attaching to Treasury Shares and related matters**

2.18 No dividend may be declared or paid, and no other distribution (whether in cash or otherwise) of the Company's assets (including any distribution of assets to Members on a winding up) may be made to the Company in respect of a Treasury Share.

2.19 The Company shall be entered in the register of Members as the holder of the Treasury Shares. However:

- (a) the Company shall not be treated as a Member for any purpose and shall not exercise any right in respect of the Treasury Shares, and any purported exercise of such a right shall be void; and
- (b) a Treasury Share shall not be voted, directly or indirectly, at any meeting of the Company and shall not be counted in determining the total number of issued shares at any given time, whether for the purposes of these Articles or the Act.

2.20 Nothing in Article 2.19 prevents an allotment of Shares as Fully Paid Up bonus shares in respect of a Treasury Share and Shares allotted as Fully Paid Up bonus shares in respect of a Treasury Share shall be treated as Treasury Shares.

2.21 Treasury Shares may be disposed of by the Company in accordance with the Act and otherwise on such terms and conditions as the Directors determine.

**Register of Members**

2.22 The Company shall keep or cause to be kept a register of Members as required by the Act and the Directors may cause the Company to maintain one or more branch registers as contemplated by the Act, provided that where the Company is maintaining one or more branch registers, the Directors shall ensure that a duplicate of each branch register is kept with the Company's principal register of Members and updated within such number of days of any amendment having been made to such branch register as may be required by the Act.

- 2.23 For as long as the Shares are listed on any Designated Stock Exchange, the title to Shares may be evidenced and transferred in accordance with the laws applicable to the rules and regulations of the Designated Stock Exchange and, for these purposes, the Register of Members may be maintained in accordance with Section 40B of the Act.

### **Annual Return**

- 2.24 The Directors in each calendar year shall prepare or cause to be prepared an annual return and declaration setting forth the particulars required by the Act and shall deliver a copy thereof to the registrar of companies for the Cayman Islands.

## **3 Share certificates**

### **Issue of share certificates**

- 3.1 A Member shall only be entitled to a share certificate if the Directors resolve that share certificates shall be issued. Share certificates representing Shares, if any, shall be in such form as the Directors may determine. If the Directors resolve that share certificates shall be issued, upon being entered in the register of Members as the holder of a Share, the Directors may issue to any Member:
- (a) without payment, one certificate for all the Shares of each class held by that Member (and, upon transferring a part of the Member's holding of Shares of any class, to a certificate for the balance of that holding); and
  - (b) upon payment of such reasonable sum as the Directors may determine for every certificate after the first, several certificates each for one or more of that Member's Shares.
- 3.2 Every certificate shall specify the number, class and distinguishing numbers (if any) of the Shares to which it relates and whether they are Fully Paid Up or Partly Paid Up. A certificate may be executed under seal or executed in such other manner as the Directors determine.
- 3.3 Every certificate shall bear legends required under the applicable laws, including the U.S. Securities Act.
- 3.4 The Company shall not be bound to issue more than one certificate for Shares held jointly by several persons and delivery of a certificate for a Share to one joint holder shall be a sufficient delivery to all of them.

### **Renewal of lost or damaged share certificates**

3.5 If a share certificate is defaced, worn-out, lost or destroyed, it may be renewed on such terms (if any) as to:

- (a) evidence;
- (b) indemnity;
- (c) payment of the expenses reasonably incurred by the Company in investigating the evidence; and
- (d) payment of a reasonable fee, if any for issuing a replacement share certificate,

as the Directors may determine, and (in the case of defacement or wearing-out) on delivery to the Company of the old certificate.

## **4 Lien on Shares**

### **Nature and scope of lien**

4.1 The Company has a first and paramount lien on all Shares (whether Fully Paid Up or not) registered in the name of a Member (whether solely or jointly with others). The lien is for all monies payable to the Company by the Member or the Member's estate:

- (a) either alone or jointly with any other person, whether or not that other person is a Member; and
- (b) whether or not those monies are presently payable.

4.2 At any time the Board may declare any Share to be wholly or partly exempt from the provisions of this Article.

### **Company may sell Shares to satisfy lien**

4.3 The Company may sell any Shares over which it has a lien if all of the following conditions are met:

- (a) the sum in respect of which the lien exists is presently payable;
- (b) the Company gives notice to the Member holding the Share (or to the person entitled to it in consequence of the death or bankruptcy of that Member) demanding payment and stating that if the notice is not complied with the Shares may be sold; and
- (c) that sum is not paid within fourteen Clear Days after that notice is deemed to be given under these Articles,

and Shares to which this Article 4.3 applies shall be referred to as Lien Default Shares.

4.4 The Lien Default Shares may be sold in such manner as the Board determines.

4.5 To the maximum extent permitted by law, the Directors shall incur no personal liability to the Member concerned in respect of the sale.

**Authority to execute instrument of transfer**

4.6 To give effect to a sale, the Directors may authorise any person to execute an instrument of transfer of the Lien Default Shares sold to, or in accordance with the directions of, the purchaser.

4.7 The title of the transferee of the Lien Default Shares shall not be affected by any irregularity or invalidity in the proceedings in respect of the sale.

**Consequences of sale of Shares to satisfy lien**

4.8 On a sale pursuant to the preceding Articles:

- (a) the name of the Member concerned shall be removed from the register of Members as the holder of those Lien Default Shares; and
- (b) that person shall deliver to the Company for cancellation the certificate (if any) for those Lien Default Shares.

4.9 Notwithstanding the provisions of Article 4.8, such person shall remain liable to the Company for all monies which, at the date of sale, were presently payable by such person to the Company in respect of those Lien Default Shares. That person shall also be liable to pay interest on those monies from the date of sale until payment at the rate at which interest was payable before that sale or, failing that, at the Default Rate. The Board may waive payment wholly or in part or enforce payment without any allowance for the value of the Lien Default Shares at the time of sale or for any consideration received on their disposal.

**Application of proceeds of sale**

4.10 The net proceeds of the sale, after payment of the costs, shall be applied in payment of so much of the sum for which the lien exists as is presently payable. Any residue shall be paid to the person whose Lien Default Shares have been sold:

- (a) if no certificate for the Lien Default Shares was issued, at the date of the sale; or
- (b) if a certificate for the Lien Default Shares was issued, upon surrender to the Company of that certificate for cancellation

but, in either case, subject to the Company retaining a like lien for all sums not presently payable as existed on the Lien Default Shares before the sale.

## **5 Calls on Shares and forfeiture**

### **Power to make calls and effect of calls**

- 5.1 Subject to the terms of allotment, the Board may make calls on the Members in respect of any monies unpaid on their Shares including any premium. The call may provide for payment to be by instalments. Subject to receiving at least 14 Clear Days' notice specifying when and where payment is to be made, each Member shall pay to the Company the amount called on such Member's Shares as required by the notice.
- 5.2 Before receipt by the Company of any sum due under a call, that call may be revoked in whole or in part and payment of a call may be postponed in whole or in part. Where a call is to be paid in instalments, the Company may revoke the call in respect of all or any remaining instalments in whole or in part and may postpone payment of all or any of the remaining instalments in whole or in part.
- 5.3 A Member on whom a call is made shall remain liable for that call notwithstanding the subsequent transfer of the Shares in respect of which the call was made. A person shall not be liable for calls made after such person is no longer registered as Member in respect of those Shares.

### **Time when call made**

- 5.4 A call shall be deemed to have been made at the time when the resolution of the Directors authorising the call was passed.

### **Liability of joint holders**

- 5.5 Members registered as the joint holders of a Share shall be jointly and severally liable to pay all calls in respect of the Share.

### **Interest on unpaid calls**

- 5.6 If a call remains unpaid after it has become due and payable the person from whom it is due and payable shall pay interest on the amount unpaid from the day it became due and payable until it is paid:
- (a) at the rate fixed by the terms of allotment of the Share or in the notice of the call; or
  - (b) if no rate is fixed, at the Default Rate.

The Directors may waive payment of the interest wholly or in part.

### **Deemed calls**

- 5.7 Any amount payable in respect of a Share, whether on allotment or on a fixed date or otherwise, shall be deemed to be payable as a call. If the amount is not paid when due the provisions of these Articles shall apply as if the amount had become due and payable by virtue of a call.

**Power to accept early payment**

- 5.8 The Company may accept from a Member the whole or a part of the amount remaining unpaid on Shares held by such person although no part of that amount has been called up.

**Power to make different arrangements at time of issue of Shares**

- 5.9 Subject to the terms of allotment, the Directors may make arrangements on the issue of Shares to distinguish between Members in the amounts and times of payment of calls on their Shares.

**Notice of default**

- 5.10 If a call remains unpaid after it has become due and payable the Directors may give to the person from whom it is due not less than 14 Clear Days' notice requiring payment of:

- (a) the amount unpaid;
- (b) any interest which may have accrued;
- (c) any expenses which have been incurred by the Company due to that person's default.

- 5.11 The notice shall state the following:

- (a) the place where payment is to be made; and
- (b) a warning that if the notice is not complied with the Shares in respect of which the call is made will be liable to be forfeited.

**Forfeiture or surrender of Shares**

- 5.12 If the notice given pursuant to Article 5.10 is not complied with, the Directors may, before the payment required by the notice has been received, resolve that any Share the subject of that notice be forfeited. The forfeiture shall include all dividends or other monies payable in respect of the forfeited Share and not paid before the forfeiture. Despite the foregoing, the Board may determine that any Share the subject of that notice be accepted by the Company as surrendered by the Member holding that Share in lieu of forfeiture.

- 5.13 The Directors may accept the surrender for no consideration of any Fully Paid Up Share.

**Disposal of forfeited or surrendered Share and power to cancel forfeiture or surrender**

- 5.14 A forfeited or surrendered Share may be sold, re-allotted or otherwise disposed of on such terms and in such manner as the Board determine either to the former Member who held that Share or to any other person. The forfeiture or surrender may be cancelled on such terms as the Directors think fit at any time before a sale, re-allotment or other disposition. Where, for the purposes of its disposal, a forfeited or surrendered Share is to be transferred to any person, the Directors may authorise some person to execute an instrument of transfer of the Share to the transferee.

**Effect of forfeiture or surrender on former Member**

5.15 On forfeiture or surrender:

- (a) the name of the Member concerned shall be removed from the register of Members as the holder of those Shares and that person shall cease to be a Member in respect of those Shares; and
- (b) that person shall surrender to the Company for cancellation the certificate (if any) for the forfeited or surrendered Shares.

5.16 Despite the forfeiture or surrender of such Member's Shares, that person shall remain liable to the Company for all monies which at the date of forfeiture or surrender were presently payable by such person to the Company in respect of those Shares together with:

- (a) all expenses; and
- (b) interest from the date of forfeiture or surrender until payment:
  - (i) at the rate of which interest was payable on those monies before forfeiture; or
  - (ii) if no interest was so payable, at the Default Rate.

The Directors, however, may waive payment wholly or in part.

**Evidence of forfeiture or surrender**

5.17 A declaration, whether statutory or under oath, made by a Director or the Secretary shall be conclusive evidence of the following matters stated in it as against all persons claiming to be entitled to forfeited Shares:

- (a) that the person making the declaration is a Director or Secretary of the Company, and
- (b) that the particular Shares have been forfeited or surrendered on a particular date.

Subject to the execution of an instrument of transfer, if necessary, the declaration shall constitute good title to the Shares.

## **Sale of forfeited or surrendered Shares**

- 5.18 Any person to whom the forfeited or surrendered Shares are disposed of shall not be bound to see to the application of the consideration, if any, of those Shares nor shall such Member's title to the Shares be affected by any irregularity in, or invalidity of the proceedings in respect of, the forfeiture, surrender or disposal of those Shares.

## **6 Transfer of Shares**

### **Right to transfer**

- 6.1 The instrument of transfer of any Share shall be in writing and in any usual or common form or such other form as the Directors may, in their absolute discretion, approve and be executed by or on behalf of the transferor and if in respect of a nil or Partly Paid Up Share, or if so required by the Directors, shall also be executed on behalf of the transferee and shall be accompanied by the certificate (if any) of the Shares to which it relates and such other evidence as the Directors may reasonably require to show the right of the transferor to make the transfer. The transferor shall be deemed to remain a Member until the name of the transferee is entered in the register of Members in respect of the relevant Shares.
- 6.2 The Directors may in their absolute discretion decline to register any transfer of Shares which is not Fully Paid Up or on which the Company has a lien.
- 6.3 The Directors may also, but are not required to, decline to register any transfer of any Share unless:
- (a) the instrument of transfer is lodged with the Company, accompanied by the certificate (if any) for the Shares to which it relates and such other evidence as the Board may reasonably require to show the right of the transferor to make the transfer;
  - (b) the instrument of transfer is in respect of only one class of Shares;
  - (c) the instrument of transfer is properly stamped, if required;
  - (d) in the case of a transfer to joint holders, the number of joint holders to whom the Share is to be transferred does not exceed four;
  - (e) the Shares transferred are Fully Paid Up and free of any lien in favour of the Company; and
  - (f) any applicable fee of such maximum sum as the Designated Stock Exchanges may determine to be payable, or such lesser sum as the Board may from time to time require, related to the transfer is paid to the Company.



### **Suspension of transfers**

- 6.4 The registration of transfers may, on 14 days' notice being given by advertisement in such one or more newspapers or by electronic means, be suspended and the register of Members closed at such times and for such periods as the Directors may, in their absolute discretion, from time to time determine, provided always that such registration of transfer shall not be suspended nor the register of Members closed for more than 30 days in any year.

### **Company may retain instrument of transfer**

- 6.5 The Company shall be entitled to retain all instruments of transfer that are registered.

### **Notice of refusal to register**

- 6.6 If the Directors refuse to register a transfer of any Shares, they shall within three months after the date on which the instrument of transfer was lodged with the Company send to each of the transferor and the transferee notice of the refusal.

## **7 Transmission of Shares**

### **Persons entitled on death of a Member**

- 7.1 If a Member dies, the only persons recognised by the Company as having any title to the deceased Members' interest are the following:
- (a) where the deceased Member was a joint holder, the survivor or survivors; and
  - (b) where the deceased Member was a sole holder, that Member's personal representative or representatives.
- 7.2 Nothing in these Articles shall release the deceased Member's estate from any liability in respect of any Share, whether the deceased was a sole holder or a joint holder.

### **Registration of transfer of a Share following death or bankruptcy**

- 7.3 A person becoming entitled to a Share in consequence of the death or bankruptcy of a Member may elect to do either of the following:
- (a) to become the holder of the Share; or
  - (b) to transfer the Share to another person.
- 7.4 That person must produce such evidence of his/her/its entitlement as the Directors may properly require.

- 7.5 If the person elects to become the holder of the Share, such person must give notice to the Company to that effect. For the purposes of these Articles, that notice shall be treated as though it were an executed instrument of transfer.
- 7.6 If the person elects to transfer the Share to another person then:
- (a) if the Share is Fully Paid Up, the transferor must execute an instrument of transfer; and
  - (b) if the Share is nil or Partly Paid Up, the transferor and the transferee must execute an instrument of transfer.
- 7.7 All the Articles relating to the transfer of Shares shall apply to the notice or, as appropriate, the instrument of transfer.

#### **Indemnity**

- 7.8 A person registered as a Member by reason of the death or bankruptcy of another Member shall indemnify the Company and the Directors against any loss or damage suffered by the Company or the Directors as a result of that registration.

#### **Rights of person entitled to a Share following death or bankruptcy**

- 7.9 A person becoming entitled to a Share by reason of the death or bankruptcy of a Member shall have the rights to which such person would be entitled if such person were registered as the holder of the Share. But, until such person is registered as Member in respect of the Share, such person shall not be entitled to attend or vote at any meeting of the Company or at any separate meeting of the holders of that class of Shares.

### **8 Alteration of capital**

#### **Increasing, consolidating, converting, dividing and cancelling share capital**

- 8.1 To the fullest extent permitted by the Act, the Company may by Ordinary Resolution do any of the following and amend its Memorandum for that purpose:
- (a) increase its share capital by new Shares of the amount fixed by that Ordinary Resolution and with the attached rights, priorities and privileges set out in that Ordinary Resolution;
  - (b) consolidate and divide all or any of its share capital into Shares of larger amount than its existing Shares;
  - (c) convert all or any of its Paid Up Shares into stock, and reconvert that stock into Paid Up Shares of any denomination;

- (d) sub-divide its Shares or any of them into Shares of an amount smaller than that fixed by the Memorandum, so, however, that in the sub-division, the proportion between the amount paid and the amount, if any, unpaid on each reduced Share shall be the same as it was in case of the Share from which the reduced Share is derived; and
- (e) cancel Shares which, at the date of the passing of that Ordinary Resolution, have not been taken or agreed to be taken by any person, and diminish the amount of its share capital by the amount of the Shares so cancelled or, in the case of Shares without nominal par value, diminish the number of Shares into which its capital is divided.

#### **Dealing with fractions resulting from consolidation of Shares**

- 8.2 Whenever, as a result of a consolidation of Shares, any Members would become entitled to fractions of a Share the Directors may on behalf of those Members deal with the fractions as it thinks fit, including (without limitation):
- (a) sell the Shares representing the fractions for the best price reasonably obtainable to any person (including, subject to the provisions of the Act, the Company); and
  - (b) distribute the net proceeds in due proportion among those Members.
- 8.3 For the purposes of Article 8.2, the Directors may authorise some person to execute an instrument of transfer of the Shares to, in accordance with the directions of, the purchaser. The transferee shall not be bound to see to the application of the purchase money nor shall the transferee's title to the Shares be affected by any irregularity in, or invalidity of, the proceedings in respect of the sale.

#### **Reducing share capital**

- 8.4 Subject to the Act and to any rights for the time being conferred on the Members holding a particular class of Shares, the Company may, by Special Resolution, reduce its share capital in any way.

### **9 Redemption and purchase of own Shares**

#### **Power to issue redeemable Shares and to purchase own Shares**

- 9.1 Subject to the Act and to any rights for the time being conferred on the Members holding a particular class of Shares, and, where applicable, the rules and regulations of the Designated Stock Exchange, and/or other competent regulatory authority or otherwise under applicable law, the Company may by its Directors:
- (a) issue Shares that are to be redeemed or liable to be redeemed, at the option of the Company or the Member holding those redeemable Shares, on the terms and in the manner its Directors determine before the issue of those Shares;

- (b) with the consent by Special Resolution of the Members holding Shares of a particular class, vary the rights attaching to that class of Shares so as to provide that those Shares are to be redeemed or are liable to be redeemed at the option of the Company on the terms and in the manner which the Directors determine at the time of such variation; and
- (c) purchase all or any of its own Shares of any class including any redeemable Shares on the terms and in the manner which the Directors determine at the time of such purchase.

The Company may make a payment in respect of the redemption or purchase of its own Shares in any manner authorised by the Act, including out of any combination of the following: capital, its profits and the proceeds of a fresh issue of Shares.

**Power to pay for redemption or purchase in cash or in specie**

- 9.2 When making a payment in respect of the redemption or purchase of Shares, the Directors may make the payment in cash or *in specie* (or partly in one and partly in the other) if so authorised by the terms of the allotment of those Shares or by the terms applying to those Shares in accordance with Article 9.1, or otherwise by agreement with the Member holding those Shares.

**Effect of redemption or purchase of a Share**

9.3 Upon the date of redemption or purchase of a Share:

- (a) the Member holding that Share shall cease to be entitled to any rights in respect of the Share other than the right to receive:
  - (i) the price for the Share; and
  - (ii) any dividend declared in respect of the Share prior to the date of redemption or purchase;
- (b) the Member's name shall be removed from the register of Members with respect to the Share; and
- (c) the Share shall be cancelled or held as a Treasury Share, as the Directors may determine.

9.4 For the purpose of Article 9.3, the date of redemption or purchase is the date when the Member's name is removed from the register of Members with respect to the Shares the subject of the redemption or purchase.

## **10 Meetings of Members**

### **Annual and extraordinary General Meetings**

- 10.1 The Company may, but shall not (unless required by the Designated Stock Exchange Rules) be obligated to, in each year hold a General Meeting as an annual General Meeting, which, if held, shall be convened by the Board, in accordance with these Articles.
- 10.2 All General Meetings other than annual General Meetings shall be called extraordinary General Meetings.

### **Power to call meetings**

- 10.3 The Directors may call a General Meeting at any time.
- 10.4 If there are insufficient Directors to constitute a quorum and the remaining Directors are unable to agree on the appointment of additional Directors, the Directors must call a General Meeting for the purpose of appointing additional Directors.
- 10.5 The Directors must also call a General Meeting if requisitioned in the manner set out in the next two Articles.
- 10.6 The requisition must be in writing and given by one or more Members who together hold at least ten per cent of the rights to vote at such General Meeting.
- 10.7 The requisition must also:
- (a) specify the purpose of the meeting.
  - (b) be signed by or on behalf of each requisitioner (and for this purpose each joint holder shall be obliged to sign). The requisition may consist of several documents in like form signed by one or more of the requisitioners; and
  - (c) be delivered in accordance with the notice provisions.
- 10.8 Should the Directors fail to call a General Meeting within 21 Clear Days' from the date of receipt of a requisition, the requisitioners or any of them may call a General Meeting within three months after the end of that period.
- 10.9 Without limitation to the foregoing, if there are insufficient Directors to constitute a quorum and the remaining Directors are unable to agree on the appointment of additional Directors, any one or more Members who together hold at least ten per cent of the rights to vote at a General Meeting may call a General Meeting for the purpose of considering the business specified in the notice of meeting which shall include as an item of business the appointment of additional Directors.

- 10.10 Members seeking to bring business before the annual General Meeting or to nominate candidates for election as Directors at the annual General Meeting must deliver notice to the principal executive offices of the Company not later than the close of business on the 90th day nor earlier than the close of business on the 120th day prior to the scheduled date of the annual General Meeting.

**Content of notice**

- 10.11 Notice of a General Meeting shall specify each of the following:
- (a) the place, the date and the hour of the meeting;
  - (b) if the meeting is to be held in two or more places, the technology that will be used to facilitate the meeting;
  - (c) subject to paragraph (d) and the requirements of (to the extent applicable) the Designated Stock Exchange Rules, the general nature of the business to be transacted; and
  - (d) if a resolution is proposed as a Special Resolution, the text of that resolution.
- 10.12 In each notice there shall appear with reasonable prominence the following statements:
- (a) that a Member who is entitled to attend and vote is entitled to appoint one or more proxies to attend and vote instead of that Member; and
  - (b) that a proxyholder need not be a Member.

**Period of notice**

- 10.13 At least twenty-one Clear Days' notice of an annual General Meeting must be given to Members. For any other General Meeting, at least fourteen Clear Days' notice must be given to Members.
- 10.14 Subject to the Act, a meeting may be convened on shorter notice, subject to the Act with the consent of the Member or Members who, individually or collectively, hold at least ninety per cent of the voting rights of all those who have a right to vote at that meeting.

**Persons entitled to receive notice**

- 10.15 Subject to the provisions of these Articles and to any restrictions imposed on any Shares, the notice shall be given to the following people:
- (a) the Members
  - (b) persons entitled to a Share in consequence of the death or bankruptcy of a Member; and

(c) the Directors.

10.16 The Board may determine that the Members entitled to receive notice of a meeting are those persons entered on the register of Members at the close of business on a day determined by the Board.

**Accidental omission to give notice or non-receipt of notice**

10.17 Proceedings at a meeting shall not be invalidated by the following:

- (a) an accidental failure to give notice of the meeting to any person entitled to notice; or
- (b) non-receipt of notice of the meeting by any person entitled to notice.

10.18 In addition, where a notice of meeting is published on a website proceedings at the meeting shall not be invalidated merely because it is accidentally published:

- (a) in a different place on the website; or
- (b) for part only of the period from the date of the notification until the conclusion of the meeting to which the notice relates.

**11 Proceedings at meetings of Members**

**Quorum**

11.1 Save as provided in the following Article, no business shall be transacted at any meeting unless a quorum is present in person or by proxy. A quorum is as follows:

- (a) if the Company has only one Member: that Member;
- (b) if the Company has more than one Member: one or more Members holding Shares that represent not less than one-third of the outstanding Shares carrying the right to vote at such General Meeting.

**Lack of quorum**

11.2 If a quorum is not present within fifteen minutes of the time appointed for the meeting, or if at any time during the meeting it becomes inquorate, then the following provisions apply:

- (a) If the meeting was requisitioned by Members, it shall be cancelled.
- (b) In any other case, the meeting shall stand adjourned to the same time and place seven days hence, or to such other time or place as is determined by the Directors. If a quorum is not present within fifteen minutes of the time appointed for the adjourned meeting, then the Members present in person or by proxy shall constitute a quorum.

### **Use of technology**

- 11.3 A person may participate in a general meeting through the medium of conference telephone, video or any other form of communications equipment providing all persons participating in a meeting are able to hear and speak to each other throughout the meeting. A person participating in this way is deemed to be present in person at the meeting.

### **Chairman**

- 11.4 The chairman of a General Meeting shall be the chairman of the Board or such other Director as the Directors have nominated to chair Board meetings in the absence of the chairman of the Board. Absent any such person being present within fifteen minutes of the time appointed for the meeting, the Directors present shall elect one of their number to chair the meeting.
- 11.5 If no Director is present within fifteen minutes of the time appointed for the meeting, or if no Director is willing to act as chairman, the Members present in person or by proxy and entitled to vote shall choose one of their number to chair the meeting.

### **Right of a Director to attend and speak**

- 11.6 Even if a Director is not a Member, he/she shall be entitled to attend and speak at any General Meeting and at any separate meeting of Members holding a particular class of Shares.

### **Accommodation of Members at meeting**

- 11.7 If it appears to the chairman of the meeting that the meeting place specified in the notice convening the meeting is inadequate to accommodate all Members entitled and wishing to attend, the meeting will be duly constituted and its proceedings valid if the chairman is satisfied that adequate facilities are available to ensure that a Member who is unable to be accommodated is able (whether at the meeting place or elsewhere):
- (a) to participate in the business for which the meeting has been convened;
  - (b) to hear and see all persons present who speak (whether by the use of microphones, loud-speakers, audio-visual communications equipment or otherwise); and
  - (c) to be heard and seen by all other persons present in the same way.

### **Security**

- 11.8 In addition to any measures which the Board may be required to take due to the location or venue of the meeting, the Board may make any arrangement and impose any restriction it considers appropriate and reasonable in the circumstances to ensure the security of a meeting including, without limitation, the searching of any person attending the meeting and the imposing of restrictions on the items of personal property that may be taken into the meeting place. The Board may refuse entry to, or eject from, a meeting a person who refuses to comply with any such arrangements or restrictions.



**Adjournment**

- 11.9 The chairman may at any time adjourn a meeting with the consent of the Members constituting a quorum. The chairman must adjourn the meeting if so directed by the meeting. No business, however, can be transacted at an adjourned meeting other than business which might properly have been transacted at the original meeting.
- 11.10 Should a meeting be adjourned for more than 7 Clear Days, whether because of a lack of quorum or otherwise, Members shall be given at least seven Clear Days' notice of the date, time and place of the adjourned meeting and the general nature of the business to be transacted. Otherwise it shall not be necessary to give any notice of the adjournment.

**Method of voting**

- 11.11 A resolution put to the vote of the meeting shall be decided on a poll.

**Taking of a poll**

- 11.12 A poll demanded on the question of adjournment shall be taken immediately.
- 11.13 A poll demanded on any other question shall be taken either immediately or at an adjourned meeting at such time and place as the chairman directs, not being more than thirty Clear Days after the poll was demanded.
- 11.14 The demand for a poll shall not prevent the meeting continuing to transact any business other than the question on which the poll was demanded.
- 11.15 A poll shall be taken in such manner as the chairman directs. He/she may appoint scrutineers (who need not be Members) and fix a place and time for declaring the result of the poll. If, through the aid of technology, the meeting is held in more than place, the chairman may appoint scrutineers in more than place; but if he/she considers that the poll cannot be effectively monitored at that meeting, the chairman shall adjourn the holding of the poll to a date, place and time when that can occur.

**Chairman's casting vote**

- 11.16 In the case of an equality of votes, the chairman of the meeting shall be entitled to a second or casting vote.

### **Amendments to resolutions**

11.17 An Ordinary Resolution to be proposed at a General Meeting may be amended by Ordinary Resolution if:

- (a) not less than 48 hours before the meeting is to take place (or such later time as the chairman of the meeting may determine), notice of the proposed amendment is given to the Company in writing by a Member entitled to vote at that meeting; and
- (b) the proposed amendment does not, in the reasonable opinion of the chairman of the meeting, materially alter the scope of the resolution.

11.18 A Special Resolution to be proposed at a General Meeting may be amended by Ordinary Resolution, if:

- (a) the chairman of the meeting proposes the amendment at the General Meeting at which the resolution is to be proposed, and
- (b) the amendment does not go beyond what the chairman considers is necessary to correct a grammatical or other non-substantive error in the resolution.

11.19 If the chairman of the meeting, acting in good faith, wrongly decides that an amendment to a resolution is out of order, the chairman's error does not invalidate the vote on that resolution.

### **Written resolutions**

11.20 Members may pass a resolution in writing without holding a meeting if the following conditions are met:

- (a) all Members entitled to vote are given notice of the resolution as if the same were being proposed at a meeting of Members;
- (b) all Members entitled so to vote;
  - (i) sign a document; or
  - (ii) sign several documents in the like form each signed by one or more of those Members; and
- (c) the signed document or documents is or are delivered to the Company, including, if the Company so nominates, by delivery of an Electronic Record by Electronic means to the address specified for that purpose.
- (d) Such written resolution shall be as effective as if it had been passed at a meeting of the Members entitled to vote duly convened and held.

11.21 If a written resolution is described as a Special Resolution or as an Ordinary Resolution, it has effect accordingly.

11.22 The Directors may determine the manner in which written resolutions shall be put to Members. In particular, they may provide, in the form of any written resolution, for each Member to indicate, out of the number of votes the Member would have been entitled to cast at a meeting to consider the resolution, how many votes such person wishes to cast in favour of the resolution and how many against the resolution or to be treated as abstentions. The result of any such written resolution shall be determined on the same basis as on a poll.

### **Sole-Member Company**

- 11.23 If the Company has only one Member, and the Member records in writing such Member's decision on a question, that record shall constitute both the passing of a resolution and the minute of it.

### **12 Voting rights of Members**

#### **Right to vote**

- 12.1 Unless their Shares carry no right to vote, or unless a call or other amount presently payable has not been paid, all Members are entitled to vote at a General Meeting, and all Members holding Shares of a particular class of Shares are entitled to vote at a meeting of the holders of that class of Shares.
- 12.2 Members may vote in person or by proxy.
- 12.3 On a poll a Member shall have one vote for each Share such person holds, unless any Share carries special voting rights.
- 12.4 No Member is bound to vote on such Member's Shares or any of them; nor is a Member bound to vote each of such Member's Shares in the same way.

#### **Rights of joint holders**

- 12.5 If Shares are held jointly, only one of the joint holders may vote. If more than one of the joint holders tenders a vote, the vote of the holder whose name in respect of those Shares appears first in the register of Members shall be accepted to the exclusion of the votes of the other joint holder.

#### **Representation of corporate Members**

- 12.6 Save where otherwise provided, a corporate Member must act by a duly authorised representative.
- 12.7 A corporate Member wishing to act by a duly authorised representative must identify that person to the Company by notice in writing.
- 12.8 The authorisation may be for any period of time, and must be delivered to the Company before the commencement of the meeting at which it is first used.
- 12.9 The Directors of the Company may require the production of any evidence which they consider necessary to determine the validity of the notice.

- 12.10 Where a duly authorised representative is present at a meeting that Member is deemed to be present in person; and the acts of the duly authorised representative are personal acts of that Member.
- 12.11 A corporate Member may revoke the appointment of a duly authorised representative at any time by notice to the Company; but such revocation will not affect the validity of any acts carried out by the duly authorised representative before the Directors of the Company had actual notice of the revocation.
- 12.12 If a clearing house (or its nominee(s)), being a corporation, is a Member, it may authorise such persons as it sees fit to act as its representative at any meeting of the Company or at any meeting of any class of Members provided that the authorisation shall specify the number and class of Shares in respect of which each such representative is so authorised. Each person so authorised under the provisions of this Article shall be deemed to have been duly authorised without further evidence of the facts and be entitled to exercise the same rights and powers on behalf of the clearing house (or its nominee(s)) as if such person was the registered holder of such Shares held by the clearing house (or its nominee(s)).

#### **Member with mental disorder**

- 12.13 A Member in respect of whom an order has been made by any court having jurisdiction (whether in the Cayman Islands or elsewhere) in matters concerning mental disorder may vote, by that Member's receiver, *curator bonis* or other person authorised in that behalf appointed by that court.
- 12.14 For the purpose of the preceding Article, evidence to the satisfaction of the Directors of the authority of the person claiming to exercise the right to vote must be received not less than 24 hours before holding the relevant meeting or the adjourned meeting in any manner specified for the delivery of forms of appointment of a proxy, whether in writing or by Electronic means. In default, the right to vote shall not be exercisable.

#### **Objections to admissibility of votes**

- 12.15 An objection to the validity of a person's vote may only be raised at the meeting or at the adjourned meeting at which the vote is sought to be tendered. Any objection duly made shall be referred to the chairman whose decision shall be final and conclusive.

#### **Form of proxy**

- 12.16 An instrument appointing a proxy shall be in any common form or in any other form approved by the Directors.
- 12.17 The instrument must be in writing and signed in one of the following ways:
- (a) by the Member; or
  - (b) by the Member's authorised attorney; or

(c) if the Member is a corporation or other body corporate, under seal or signed by an authorised officer, secretary or attorney.

If the Directors so resolve, the Company may accept an Electronic Record of that instrument delivered in the manner specified below and otherwise satisfying the Articles about authentication of Electronic Records.

12.18 The Directors may require the production of any evidence which they consider necessary to determine the validity of any appointment of a proxy.

12.19 A Member may revoke the appointment of a proxy at any time by notice to the Company duly signed in accordance with Article 12.17.

12.20 No revocation by a Member of the appointment of a proxy made in accordance with Article 12.19 will affect the validity of any acts carried out by the relevant proxy before the Directors of the Company had actual notice of the revocation.

#### **How and when proxy is to be delivered**

12.21 Subject to the following Articles, the Directors may, in the notice convening any meeting or adjourned meeting, or in an instrument of proxy sent out by the Company, specify the manner by which the instrument appointing a proxy shall be deposited and the place and the time (being not later than the time appointed for the commencement of the meeting or adjourned meeting to which the proxy relates) at which the instrument appointing a proxy shall be deposited. In the absence of any such direction from the Directors in the notice convening any meeting or adjourned meeting or in an instrument of proxy sent out by the Company, the form of appointment of a proxy and any authority under which it is signed (or a copy of the authority certified notially or in any other way approved by the Directors) must be delivered so that it is received by the Company before the time for holding the meeting or adjourned meeting at which the person named in the form of appointment of proxy proposes to vote. They must be delivered in either of the following ways:

(a) In the case of an instrument in writing, it must be left at or sent by post:

(i) to the registered office of the Company; or

(ii) to such other place specified in the notice convening the meeting or in any form of appointment of proxy sent out by the Company in relation to the meeting.

(b) If, pursuant to the notice provisions, a notice may be given to the Company in an Electronic Record, an Electronic Record of an appointment of a proxy must be sent to the address specified pursuant to those provisions unless another address for that purpose is specified:

(i) in the notice convening the meeting; or

- (ii) in any form of appointment of a proxy sent out by the Company in relation to the meeting; or
  - (iii) in any invitation to appoint a proxy issued by the Company in relation to the meeting.
- (c) Notwithstanding Article 12.21(a) and Article 12.21(b), the chairman of the Company may, in any event at his/her discretion, direct that an instrument of proxy shall be deemed to have been duly deposited.

12.22 Where a poll is taken:

- (a) if it is taken more than seven Clear Days after it is demanded, the form of appointment of a proxy and any accompanying authority (or an Electronic Record of the same) must be delivered in accordance with Article 12.21 before the time appointed for the taking of the poll;
- (b) if it to be taken within seven Clear Days after it was demanded, the form of appointment of a proxy and any accompanying authority (or an Electronic Record of the same) must be delivered in accordance with Article 12.21 before the time appointed for the taking of the poll.

12.23 If the form of appointment of proxy is not delivered on time, it is invalid.

12.24 When two or more valid but differing appointments of proxy are delivered or received in respect of the same Share for use at the same meeting and in respect of the same matter, the one which is last validly delivered or received (regardless of its date or of the date of its execution) shall be treated as replacing and revoking the other or others as regards that Share. If the Company is unable to determine which appointment was last validly delivered or received, none of them shall be treated as valid in respect of that Share.

12.25 The Board may at the expense of the Company send forms of appointment of proxy to the Members by post (that is to say, pre-paying and posting a letter), or by Electronic communication or otherwise (with or without provision for their return by pre-paid post) for use at any General Meeting or at any separate meeting of the holders of any class of Shares, either blank or nominating as proxy in the alternative any one or more of the Directors or any other person. If for the purpose of any meeting invitations to appoint as proxy a person or one of a number of persons specified in the invitations are issued at the Company's expense, they shall be issued to all (and not to some only) of the Members entitled to be sent notice of the meeting and to vote at it. The accidental omission to send such a form of appointment or to give such an invitation to, or the non-receipt of such form of appointment by, any Member entitled to attend and vote at a meeting shall not invalidate the proceedings at that meeting

**Voting by proxy**

12.26 A proxy shall have the same voting rights at a meeting or adjourned meeting as the Member would have had except to the extent that the instrument appointing such person limits those rights. Notwithstanding the appointment of a proxy, a Member may attend and vote at a meeting or adjourned meeting. If a Member votes on any resolution a vote by such Member's proxy on the same resolution, unless in respect of different Shares, shall be invalid.

**13 Number of Directors**

13.1 There shall be a Board consisting of not less than three persons provided however that the Company may by Ordinary Resolution increase or reduce the limits in the number of Directors. Unless fixed by Ordinary Resolution, the maximum number of Directors shall be unlimited.

**14 Appointment, disqualification and removal of Directors****First Directors**

14.1 The first Directors shall be appointed in writing by the subscriber or subscribers to the Memorandum, or a majority of them.

**No age limit**

14.2 There is no age limit for Directors save that they must be at least eighteen years of age.

**Corporate Directors**

14.3 Unless prohibited by law, a body corporate may be a Director. If a body corporate is a Director, the Articles about representation of corporate Members at General Meetings apply, mutatis mutandis, to the Articles about Directors' meetings.

**No shareholding qualification**

14.4 Unless a shareholding qualification for Directors is fixed by Ordinary Resolution, no Director shall be required to own Shares as a condition of his/her appointment.

**Appointment of Directors**

14.5 A Director may be appointed by Ordinary Resolution or by the Directors. Any appointment may be to fill a vacancy or as an additional Director.

14.6 A remaining Director may appoint a Director even though there is not a quorum of Directors.

14.7 No appointment can cause the number of Directors to exceed the maximum (if one is set); and any such appointment shall be invalid.

14.8 Subject to Article 17.14, for so long as Shares are listed on a Designated Stock Exchange, the Directors shall include at least such number of Independent Directors as applicable law, rules or regulations or the Designated Stock Exchange Rules require as determined by the Board.

#### **Board's power to appoint Directors**

14.9 Without prejudice to the Company's power to appoint a person to be a Director pursuant to these Articles, the Board shall have power at any time to appoint any person who is willing to act as a Director, either to fill a vacancy or as an addition to the existing Board, subject to the total number of Directors not exceeding any maximum number fixed by or in accordance with these Articles.

14.10 Any Director so appointed shall, if still a Director, retire at the next annual General Meeting after his/her appointment and be eligible to stand for election as a Director at such meeting.

#### **Eligibility**

14.11 No person (other than a Director retiring in accordance with these Articles) shall be appointed or re-appointed a Director at any General Meeting unless:

- (a) such person is recommended by the Board; or
- (b) not less than seven nor more than forty-two Clear Days before the date appointed for the meeting, a Member (other than the person to be proposed) entitled to vote at the meeting has given to the Company notice of such Member's intention to propose a resolution for the appointment of that person, stating the particulars which would, if that person were so appointed, be required to be included in the Company's register of Directors and a notice executed by that person of his/her willingness to be appointed.

#### **Appointment at annual General Meeting**

14.12 Unless re-appointed pursuant to the provisions of Article 14.5 or removed from office pursuant to the provisions of Article 14.13, each Director shall be appointed for a term expiring at the next-following annual General Meeting of the Company. At any such annual General Meeting, Directors will be elected by Ordinary Resolution. At each annual General Meeting of the Company, each Director elected at such meeting shall be elected to hold office for a one-year term and until the election of their respective successors in office or removal pursuant to Articles 14.5 and 14.13.

#### **Removal of Directors**

14.13 A Director may be removed by Ordinary Resolution.



### **Resignation of Directors**

- 14.14 A Director may at any time resign office by giving to the Company notice in writing or, if permitted pursuant to the notice provisions, in an Electronic Record delivered in either case in accordance with those provisions.
- 14.15 Unless the notice specifies a different date, the Director shall be deemed to have resigned on the date that the notice is delivered to the Company.

### **Termination of the office of Director**

- 14.16 A Director may retire from office as a Director by giving notice in writing to that effect to the Company at the registered office, which notice shall be effective upon such date as may be specified in the notice, failing which upon delivery to the registered office.
- 14.17 Without prejudice to the provisions in these Articles for retirement (by rotation or otherwise), a Director's office shall be terminated forthwith if:
- (a) he/she is prohibited by the law of the Cayman Islands from acting as a Director; or
  - (b) he/she is made bankrupt or makes an arrangement or composition with his/her creditors generally; or
  - (c) he/she resigns his/her office by notice to the Company; or
  - (d) he/she only held office as a Director for a fixed term and such term expires; or
  - (e) in the opinion of a registered medical practitioner by whom he/she is being treated he/she becomes physically or mentally incapable of acting as a Director; or
  - (f) the majority of the other Directors (being not less than two in number) determine that he/she should be removed as a Director, either by a resolution passed by the majority of the other Directors at a meeting of the Directors duly convened and held in accordance with these Articles or by a resolution in writing signed by the majority of the other Directors; or
  - (g) he/she is made subject to any law relating to mental health or incompetence, whether by court order or otherwise; or
  - (h) without the consent of the other Directors, he/she is absent from meetings of Directors for a continuous period of six months.

## 15 Alternate Directors

### Appointment and removal

- 15.1 Any Director may appoint any other person, including another Director, to act in his/her place as an alternate Director. No appointment shall take effect until the Director has given notice of the appointment to the Board.
- 15.2 Without limitation to the preceding Article, a Director may appoint an alternate for a particular meeting by sending an email to his/her fellow Directors informing them that they are to take such email as notice of such appointment for such meeting. Such appointment shall be effective without the need for a signed notice of appointment or the giving of notice to the Company in accordance with Article 15.4.
- 15.3 A Director may revoke his/her appointment of an alternate at any time. No revocation shall take effect until the Director has given notice of the revocation to the Board.
- 15.4 Subject to Article 15.2, a notice of appointment or removal of an alternate Director shall be effective only if given to the Company by one or more of the following methods:
- (a) by notice in writing in accordance with the notice provisions contained in these Articles;
  - (b) if the Company has a facsimile address for the time being, by sending by facsimile transmission to that facsimile address a facsimile copy or, otherwise, by sending by facsimile transmission to the facsimile address of the Company's registered office a facsimile copy (in either case, the facsimile copy being deemed to be the notice unless Article 29.7 applies), in which event notice shall be taken to be given on the date of an error-free transmission report from the sender's fax machine;
  - (c) if the Company has an email address for the time being, by emailing to that email address a scanned copy of the notice as a PDF attachment or, otherwise, by emailing to the email address provided by the Company's registered office a scanned copy of the notice as a PDF attachment (in either case, the PDF version being deemed to be the notice unless Article 29.7 applies), in which event notice shall be taken to be given on the date of receipt by the Company or the Company's registered office (as appropriate) in readable form; or
  - (d) if permitted pursuant to the notice provisions, in some other form of approved Electronic Record delivered in accordance with those provisions in writing.

### Notices

- 15.5 All notices of meetings of Directors shall continue to be given to the appointing Director and not to the alternate.

### **Rights of alternate Director**

15.6 An alternate Director shall be entitled to attend and vote at any Board meeting or meeting of a committee of the Directors at which the appointing Director is not personally present, and generally to perform all the functions of the appointing Director in his/her absence. An alternate Director, however, is not entitled to receive any remuneration from the Company for services rendered as an alternate Director.

### **Appointment ceases when the appointor ceases to be a Director**

15.7 An alternate Director shall cease to be an alternate Director if:

- (a) the Director who appointed him/her ceases to be a Director; or
- (b) the Director who appointed him/her revokes his/her appointment by notice delivered to the Board or to the registered office of the Company or in any other manner approved by the Board; or
- (c) in any event happens in relation to him/her which, if he/she were a Director of the Company, would cause his/her office as Director to be vacated.

### **Status of alternate Director**

15.8 An alternate Director shall carry out all functions of the Director who made the appointment.

15.9 Save where otherwise expressed, an alternate Director shall be treated as a Director under these Articles.

15.10 An alternate Director is not the agent of the Director appointing him/her.

15.11 An alternate Director is not entitled to any remuneration for acting as alternate Director.

### **Status of the Director making the appointment**

15.12 A Director who has appointed an alternate is not thereby relieved from the duties which he/she owes the Company.

## **16 Powers of Directors**

### **Powers of Directors**

16.1 Subject to the provisions of the Act, the Memorandum and these Articles the business of the Company shall be managed by the Directors who may for that purpose exercise all the powers of the Company.

16.2 No prior act of the Directors shall be invalidated by any subsequent alteration of the Memorandum or these Articles. However, to the extent allowed by the Act, Members may, by Special Resolution, validate any prior or future act of the Directors which would otherwise be in breach of their duties.

### **Directors below the minimum number**

- 16.3 If the number of Directors is less than the minimum prescribed in accordance with these Articles, the remaining Director or Directors shall act only for the purposes of appointing an additional Director or Directors to make up such minimum or of convening a General Meeting of the Company for the purpose of making such appointment. If there are no Director or Directors able or willing to act, any two Members may summon a General Meeting for the purpose of appointing Directors. Any additional Director so appointed shall hold office (subject to these Articles) only until the dissolution of the annual General Meeting next following such appointment unless he/she is re-elected during such meeting.

### **Appointments to office**

- 16.4 The Directors may appoint a Director:

- (a) as chairman of the Board;
- (b) as managing Director;
- (c) to any other executive office,

for such period, and on such terms, including as to remuneration as they think fit.

- 16.5 The appointee must consent in writing to holding that office.

- 16.6 Where a chairman is appointed he/she shall, unless unable to do so, preside at every meeting of Directors.

- 16.7 If there is no chairman, or if the chairman is unable to preside at a meeting, that meeting may select its own chairman; or the Directors may nominate one of their member to act in place of the chairman should he/she ever not be available.

- 16.8 Subject to the provisions of the Act, the Directors may also appoint and remove any person, who need not be a Director:

- (a) as Secretary; and
- (b) to any office that may be required

for such period and on such terms, including as to remuneration, as they think fit. In the case of an Officer, that Officer may be given any title the Directors decide.

- 16.9 The Secretary or Officer must consent in writing to holding that office.

16.10 A Director, Secretary or other Officer of the Company may not hold the office, or perform the services, of auditor.

**Provisions for employees**

16.11 The Board may make provision for the benefit of any persons employed or formerly employed by the Company or any of its subsidiary undertakings (or any member of his/her family or any person who is dependent on him/her) in connection with the cessation or the transfer to any person of the whole or part of the undertaking of the Company or any of its subsidiary undertakings.

**Exercise of voting rights**

16.12 The Board may exercise the voting power conferred by the Shares in any body corporate held or owned by the Company in such manner in all respects as it thinks fit (including, without limitation, the exercise of that power in favour of any resolution appointing any Director as a director of such body corporate, or voting or providing for the payment of remuneration to the directors of such body corporate).

**Remuneration**

16.13 Every Director may be remunerated by the Company for the services he/she provides for the benefit of the Company, whether as Director, employee or otherwise, and shall be entitled to be paid for the expenses incurred in the Company's business including attendance at Directors' meetings.

16.14 Until otherwise determined by the Company by Ordinary Resolution, the Directors (other than alternate Directors) shall be entitled to such remuneration by way of fees for their services in the office of Director as the Directors may determine.

16.15 Remuneration may take any form and may include arrangements to pay pensions, health insurance, death or sickness benefits, whether to the Director or to any other person connected to or related to him/her.

16.16 Unless his/her fellow Directors determine otherwise, a Director is not accountable to the Company for remuneration or other benefits received from any other company which is in the same group as the Company or which has common shareholdings.

## **Disclosure of information**

- 16.17 The Directors may release or disclose to a third party any information regarding the affairs of the Company, including any information contained in the register of Members relating to a Member, (and they may authorise any Director, Officer or other authorised agent of the Company to release or disclose to a third party any such information in such person's possession) if:
- (a) the Company or that person, as the case may be, is lawfully required to do so under the laws of any jurisdiction to which the Company is subject; or
  - (b) such disclosure is in compliance with the Designated Stock Exchange Rules; or
  - (c) such disclosure is in accordance with any contract entered into by the Company; or
  - (d) the Directors are of the opinion such disclosure would assist or facilitate the Company's operations.

## **17 Delegation of powers**

### **Power to delegate any of the Directors' powers to a committee**

- 17.1 The Directors may delegate any of their powers to any committee consisting of one or more persons who need not be Members. Persons on the committee may include non-Directors so long as the majority of those persons are Directors. Any such committee shall be made up of such number of Independent Directors as required from time to time by the Designated Stock Exchange Rules or otherwise required by applicable law.
- 17.2 The delegation may be collateral with, or to the exclusion of, the Directors' own powers.
- 17.3 The delegation may be on such terms as the Directors think fit, including provision for the committee itself to delegate to a sub-committee; save that any delegation must be capable of being revoked or altered by the Directors at will.
- 17.4 Unless otherwise permitted by the Directors, a committee must follow the procedures prescribed for the taking of decisions by Directors.
- 17.5 Subject to Article 17.14, the Board shall be entitled to establish, among others, an audit committee, a compensation committee and a nominating and corporate governance committee. Each of these committees shall be empowered to do all things necessary to exercise the rights of such committee set forth in these Articles. Each of the audit committee, compensation committee and nominating and corporate governance committee shall consist of at least three Directors (or such larger minimum number as may be required from time to time by the Designated Stock Exchange Rules). Subject to Article 17.14, the majority of the committee members on each of the compensation committee and nominating and corporate governance committee shall be Independent Directors. The audit committee shall be made up of such number of Independent Directors as required from time to time by the Designated Stock Exchange Rules or otherwise required by applicable law.

### **Local boards**

- 17.6 The Board may establish any local or divisional board or agency for managing any of the affairs of the Company whether in the Cayman Islands or elsewhere and may appoint any persons to be members of a local or divisional Board, or to be managers or agents, and may fix their remuneration.

17.7 The Board may delegate to any local or divisional board, manager or agent any of its powers and authorities (with power to sub-delegate) and may authorise the members of any local or divisional board or any of them to fill any vacancies and to act notwithstanding vacancies.

17.8 Any appointment or delegation under this Article 17.8 may be made on such terms and subject to such conditions as the Board thinks fit and the Board may remove any person so appointed, and may revoke or vary any delegation.

**Power to appoint an agent of the Company**

17.9 The Directors may appoint any person, either generally or in respect of any specific matter, to be the agent of the Company with or without authority for that person to delegate all or any of that person's powers. The Directors may make that appointment:

- (a) by causing the Company to enter into a power of attorney or agreement; or
- (b) in any other manner they determine.

**Power to appoint an attorney or authorised signatory of the Company**

17.10 The Directors may appoint any person, whether nominated directly or indirectly by the Directors, to be the attorney or the authorised signatory of the Company. The appointment may be:

- (a) for any purpose;
- (b) with the powers, authorities and discretions;
- (c) for the period; and
- (d) subject to such conditions

as they think fit. The powers, authorities and discretions, however, must not exceed those vested in, or exercisable, by the Directors under these Articles. The Directors may do so by power of attorney or any other manner they think fit.

17.11 Any power of attorney or other appointment may contain such provision for the protection and convenience for persons dealing with the attorney or authorised signatory as the Directors think fit. Any power of attorney or other appointment may also authorise the attorney or authorised signatory to delegate all or any of the powers, authorities and discretions vested in that person.

17.12 The Board may remove any person appointed under Article 17.10 and may revoke or vary the delegation.

### **Borrowing Powers**

- 17.13 The Directors may exercise all the powers of the Company to borrow money and to mortgage or charge its undertaking, property and assets both present and future and uncalled capital, or any part thereof, and to issue debentures and other securities, whether outright or as collateral security for any debt, liability or obligation of the Company or its parent undertaking (if any) or any subsidiary undertaking of the Company or of any third party.

### **Corporate Governance**

- 17.14 The Board may, from time to time, and except as required by applicable law or the Designated Stock Exchange Rules, adopt, institute, amend, modify or revoke the corporate governance policies or initiatives of the Company, which shall be intended to set forth the guiding principles and policies of the Company and the Board on various corporate governance related matters as the Board shall determine by resolution from time to time.

### **18 Meetings of Directors**

#### **Regulation of Directors' meetings**

- 18.1 Subject to the provisions of these Articles, the Directors may regulate their proceedings as they think fit.

#### **Calling meetings**

- 18.2 Any Director may call a meeting of Directors at any time. The Secretary must call a meeting of the Directors if requested to do so by a Director.

#### **Notice of meetings**

- 18.3 Notice of a Board meeting may be given to a Director personally or by word of mouth or given in writing or by Electronic communications at such address as he/she may from time to time specify for this purpose (or, if he/she does not specify an address, at his/her last known address). A Director may waive his/her right to receive notice of any meeting either prospectively or retrospectively.
- 18.4 Every Director shall be given notice of a meeting, although a Director may waive retrospectively the requirement to be given notice. Attendance at a meeting without written objection shall be deemed to be a waiver of such notice requirement.

#### **Use of technology**

- 18.5 A Director may participate in a meeting of Directors through the medium of conference telephone, video or any other form of communications equipment providing all persons participating in the meeting are able to hear and speak to each other throughout the meeting.
- 18.6 A Director participating in this way is deemed to be present in person at the meeting.



**Quorum**

18.7 The quorum for the transaction of business at a meeting of Directors shall be two unless the Directors fix some other number.

**Chairman or deputy to preside**

18.8 The Board may appoint a chairman and one or more deputy chairman or chairmen and may at any time revoke any such appointment.

18.9 The chairman, or failing him/her any deputy chairman (the longest in office taking precedence if more than one is present), shall preside at all Board meetings. If no chairman or deputy chairman has been appointed, or if he/she is not present within five minutes after the time fixed for holding the meeting, or is unwilling to act as chairman of the meeting, the Directors present shall choose one of their member to act as chairman of the meeting.

**Voting**

18.10 A question which arises at a Board meeting shall be decided by a majority of votes. If votes are equal the chairman may, if he/she wishes, exercise a casting vote.

**Recording of dissent**

18.11 A Director present at a meeting of Directors shall be presumed to have assented to any action taken at that meeting unless:

- (a) his/her dissent is entered in the minutes of the meeting; or
- (b) he has filed with the meeting before it is concluded signed dissent from that action; or
- (c) he has forwarded to the Company as soon as practical following the conclusion of that meeting signed dissent.

A Director who votes in favour of an action is not entitled to record his/her dissent to it.

**Written resolutions**

18.12 The Directors may pass a resolution in writing without holding a meeting if all Directors sign a document or sign several documents in the like form each signed by one or more of those Directors.

18.13 A written resolution signed by a validly appointed alternate Director need not also be signed by the appointing Director.

18.14 A written resolution signed personally by the appointing Director need not also be signed by his/her alternate.

- 18.15 A resolution in writing passed pursuant to Article 18.12, Article 18.13 and/or Article 18.14 shall be as effective as if it had been passed at a meeting of the Directors duly convened and held; and it shall be treated as having been passed on the day and at the time that the last Director signs (and for the avoidance of doubt, such day may or may not be a Business Day).

**Validity of acts of Directors in spite of formal defect**

- 18.16 All acts done by a meeting of the Board, or of a committee of the Board, or by any person acting as a Director or an alternate Director, shall, notwithstanding that it is afterwards discovered that there was some defect in the appointment of any Director or alternate Director or member of the committee, or that any of them were disqualified or had vacated office or were not entitled to vote, be as valid as if every such person had been duly appointed and qualified and had continued to be a Director or alternate Director and had been entitled to vote.

**19 Permissible Directors' interests and disclosure**

**Permissible interests subject to disclosure**

- 19.1 Save as expressly permitted by these Articles or as set out below, a Director may not have a direct or indirect interest or duty which conflicts or may possibly conflict with the interests of the Company.
- 19.2 If, notwithstanding the prohibition in the preceding Article, a Director discloses to his/her fellow Directors the nature and extent of any material interest or duty in accordance with the next Article, he/she may:
- (a) be a party to, or otherwise interested in, any transaction or arrangement with the Company or in which the Company is or may otherwise be interested; or
  - (b) be interested in another body corporate promoted by the Company or in which the Company is otherwise interested. In particular, the Director may be a director, secretary or officer of, or employed by, or be a party to any transaction or arrangement with, or otherwise interested in, that other body corporate.
- 19.3 Such disclosure may be made at a meeting of the board or otherwise (and, if otherwise, it must be made in writing). The Director must disclose the nature and extent of his/her direct or indirect interest in or duty in relation to a transaction or arrangement or series of transactions or arrangements with the Company or in which the Company has any material interest.
- 19.4 If a Director has made disclosure in accordance with the preceding Article, then he/she shall not, by reason only of his/her office, be accountable to the Company for any benefit that he/she derives from any such transaction or arrangement or from any such office or employment or from any interest in any such body corporate, and no such transaction or arrangement shall be liable to be avoided on the ground of any such interest or benefit.

## **Notification of interests**

19.5 For the purposes of the preceding Articles:

- (a) a general notice that a Director gives to the other Directors that he/she is to be regarded as having an interest of the nature and extent specified in the notice in any transaction or arrangement in which a specified person or class of persons is interested shall be deemed to be a disclosure that he/she has an interest in or duty in relation to any such transaction of the nature and extent so specified; and
- (b) an interest of which a Director has no knowledge and of which it is unreasonable to expect such Director to have knowledge shall not be treated as an interest of his/her.

## **Voting where a Director is interested in a matter**

19.6 A Director may vote at a meeting of Directors on any resolution concerning a matter in which that Director has an interest or duty, whether directly or indirectly, so long as that Director discloses any material interest pursuant to these Articles. The Director shall be counted towards a quorum of those present at the meeting. If the Director votes on the resolution, his/her vote shall be counted.

19.7 Where proposals are under consideration concerning the appointment of two or more Directors to offices or employment with the Company or any body corporate in which the Company is interested, the proposals may be divided and considered in relation to each Director separately and each of the Directors concerned shall be entitled to vote and be counted in the quorum in respect of each resolution except that concerning his or her own appointment.

## **20 Minutes**

20.1 The Company shall cause minutes to be made in books of:

- (a) all appointments of Officers and committees made by the Board and of any such Officer's remuneration; and
- (b) the names of Directors present at every meeting of the Directors, a committee of the Board, the Company or the holders of any class of shares or debentures, and all orders, resolutions and proceedings of such meetings.

20.2 Any such minutes, if purporting to be signed by the chairman of the meeting at which the proceedings were held or by the chairman of the next succeeding meeting or the Secretary, shall be prima facie evidence of the matters stated in them.

## **21 Accounts and audit; Financial year**

- 21.1 The Directors must ensure that proper accounting and other records are kept, and that accounts and associated reports are distributed in accordance with the requirements of the Act.
- 21.2 Unless the Directors otherwise prescribe, the financial year of the Company shall end on 30 June in each year and begin on 1 July in each year.

### **Auditors**

- 21.3 The Directors may appoint an Auditor of the Company who shall hold office on such terms as the Directors determine.
- 21.4 At any General Meeting convened and held at any time in accordance with these Articles, the Members may, by Ordinary Resolution, remove the Auditor before the expiration of its term of office. If they do so, the Members shall, by Ordinary Resolution, at that meeting appoint another Auditor in its stead for the remainder of its term.
- 21.5 The Auditors shall examine such books, accounts and vouchers; as may be necessary for the performance of their duties.
- 21.6 The Auditors shall, if so requested by the Directors, make a report on the accounts of the Company during their tenure of office at the next annual General Meeting following their appointment, and at any time during their term of office, upon request of the Directors or any General Meeting of the Company.

## **22 Record dates**

- 22.1 Except to the extent of any conflicting rights attached to Shares, the resolution declaring a dividend on Shares of any class, whether it be an Ordinary Resolution of the Members or a Director's resolution, may specify that the dividend is payable or distributable to the persons registered as the holders of those Shares at the close of business on a particular date, notwithstanding that the date may be a date prior to that on which the resolution is passed.
- 22.2 If the resolution does so specify, the dividend shall be payable or distributable to the persons registered as the holders of those Shares at the close of business on the specified date in accordance with their respective holdings so registered, but without prejudice to the rights *inter se* in respect of the dividend of transferors and transferees of any of those Shares.
- 22.3 The provisions of this Article apply, *mutatis mutandis*, to bonuses, capitalisation issues, distributions of realised capital profits or offers or grants made by the Company to the Members.

## 23 Dividends

### Source of dividends

- 23.1 Dividends may be declared and paid out of any funds of the Company lawfully available for distribution.
- 23.2 Subject to the requirements of the Act regarding the application of a company's Share premium account and with the sanction of an Ordinary Resolution, dividends may also be declared and paid out of any share premium account.

### Declaration of dividends by Members

- 23.3 Subject to the provisions of the Act, the Company may by Ordinary Resolution declare dividends in accordance with the respective rights of the Members but no dividend shall exceed the amount recommended by the Directors.

### Payment of interim dividends and declaration of final dividends by Directors

- 23.4 The Directors may declare and pay interim dividends or recommend final dividends in accordance with the respective rights of the Members if it appears to them that they are justified by the financial position of the Company and that such dividends may lawfully be paid.
- 23.5 Subject to the provisions of the Act, in relation to the distinction between interim dividends and final dividends, the following applies:
- (a) Upon determination to pay a dividend or dividends described as interim by the Directors in the dividend resolution, no debt shall be created by the declaration until such time as payment is made.
  - (b) Upon declaration of a dividend or dividends described as final by the Directors in the dividend resolution, a debt shall be created immediately following the declaration, the due date to be the date the dividend is stated to be payable in the resolution.

If the resolution fails to specify whether a dividend is final or interim, it shall be assumed to be interim.

- 23.6 In relation to Shares carrying differing rights to dividends or rights to dividends at a fixed rate, the following applies:
- (a) If the share capital is divided into different classes, the Directors may pay dividends on Shares which confer deferred or non-preferred rights with regard to dividends as well as on Shares which confer preferential rights with regard to dividends but no dividend shall be paid on Shares carrying deferred or non-preferred rights if, at the time of payment, any preferential dividend is in arrears.

- (b) The Directors may also pay, at intervals settled by them, any dividend payable at a fixed rate if it appears to them that there are sufficient funds of the Company lawfully available for distribution to justify the payment.
- (c) If the Directors act in good faith, they shall not incur any liability to the Members holding Shares conferring preferred rights for any loss those Members may suffer by the lawful payment of the dividend on any Shares having deferred or non-preferred rights.

#### **Apportionment of dividends**

- 23.7 Except as otherwise provided by the rights attached to Shares all dividends shall be declared and paid according to the amounts Paid Up on the Shares on which the dividend is paid. All dividends shall be apportioned and paid proportionately to the amount Paid Up on the Shares during the time or part of the time in respect of which the dividend is paid. But if a Share is issued on terms providing that it shall rank for dividend as from a particular date, that Share shall rank for dividend accordingly.

#### **Right of set off**

- 23.8 The Directors may deduct from a dividend or any other amount payable to a person in respect of a Share any amount due by that person to the Company on a call or otherwise in relation to a Share.

#### **Power to pay other than in cash**

- 23.9 If the Directors so determine, any resolution declaring a dividend may direct that it shall be satisfied wholly or partly by the distribution of assets. If a difficulty arises in relation to the distribution, the Directors may settle that difficulty in any way they consider appropriate. For example, they may do any one or more of the following:
- (a) issue fractional Shares;
  - (b) fix the value of assets for distribution and make cash payments to some Members on the footing of the value so fixed in order to adjust the rights of Members; and
  - (c) vest some assets in trustees.

#### **How payments may be made**

- 23.10 A dividend or other monies payable on or in respect of a Share may be paid in any of the following ways:
- (a) if the Member holding that Share or other person entitled to that Share nominates a bank account for that purpose - by wire transfer to that bank account;  
or

(b) by cheque or warrant sent by post to the registered address of the Member holding that Share or other person entitled to that Share.

23.11 For the purposes of Article 23.10(a), the nomination may be in writing or in an Electronic Record and the bank account nominated may be the bank account of another person. For the purposes of Article 23.10(b), subject to any applicable law or regulation, the cheque or warrant shall be made to the order of the Member holding that Share or other person entitled to the Share or to his nominee, whether nominated in writing or in an Electronic Record, and payment of the cheque or warrant shall be a good discharge to the Company.

23.12 If two or more persons are registered as the holders of the Share or are jointly entitled to it by reason of the death or bankruptcy of the registered holder (**Joint Holders**), a dividend (or other amount) payable on or in respect of that Share may be paid as follows:

(a) to the registered address of the Joint Holder of the Share who is named first on the register of Members or to the registered address of the deceased or bankrupt holder, as the case may be; or

(b) to the address or bank account of another person nominated by the Joint Holders, whether that nomination is in writing or in an Electronic Record.

23.13 Any Joint Holder of a Share may give a valid receipt for a dividend (or other amount) payable in respect of that Share.

#### **Dividends or other monies not to bear interest in absence of special rights**

23.14 Unless provided for by the rights attached to a Share, no dividend or other monies payable by the Company in respect of a Share shall bear interest.

#### **Dividends unable to be paid or unclaimed**

23.15 If a dividend cannot be paid to a Member or remains unclaimed within six weeks after it was declared or both, the Directors may pay it into a separate account in the Company's name. If a dividend is paid into a separate account, the Company shall not be constituted trustee in respect of that account and the dividend shall remain a debt due to the Member.

23.16 A dividend that remains unclaimed for a period of six years after it became due for payment shall be forfeited to, and shall cease to remain owing by, the Company.

#### **24 Capitalisation of profits**

##### **Capitalisation of profits or of any share premium account or capital redemption reserve;**

24.1 The Directors may resolve to capitalise:

(a) any part of the Company's profits not required for paying any preferential dividend (whether or not those profits are available for distribution); or

(b) any sum standing to the credit of the Company's share premium account or capital redemption reserve, if any.

24.2 The amount resolved to be capitalised must be appropriated to the Members who would have been entitled to it had it been distributed by way of dividend and in the same proportions. The benefit to each Member so entitled must be given in either or both of the following ways::

(a) by paying up the amounts unpaid on that Member's Shares;

(b) by issuing Fully Paid Up Shares, debentures or other securities of the Company to that Member or as that Member directs. The Directors may resolve that any Shares issued to the Member in respect of Partly Paid Up Shares (**Original Shares**) rank for dividend only to the extent that the Original Shares rank for dividend while those Original Shares remain Partly Paid Up.

#### **Applying an amount for the benefit of Members**

24.3 The amount capitalised must be applied to the benefit of Members in the proportions to which the Members would have been entitled to dividends if the amount capitalised had been distributed as a dividend.

24.4 Subject to the Act, if a fraction of a Share, a debenture or other security is allocated to a Member, the Directors may issue a fractional certificate to that Member or pay such person the cash equivalent of the fraction.

#### **25 Share Premium Account**

##### **Directors to maintain share premium account**

25.1 The Directors shall establish a share premium account in accordance with the Act. They shall carry to the credit of that account from time to time an amount equal to the amount or value of the premium paid on the issue of any Share or capital contributed or such other amounts required by the Act.

##### **Debits to share premium account**

25.2 The following amounts shall be debited to any share premium account:

(a) on the redemption or purchase of a Share, the difference between the nominal value of that Share and the redemption or purchase price; and

(b) any other amount paid out of a share premium account as permitted by the Act.

25.3 Notwithstanding the preceding Article, on the redemption or purchase of a Share, the Directors may pay the difference between the nominal value of that Share and the redemption purchase price out of the profits of the Company or, as permitted by the Act, out of capital.



## 26 Seal

### Company seal

26.1 The Company may have a seal if the Directors so determine.

### Duplicate seal

26.2 Subject to the provisions of the Act, the Company may also have a duplicate seal or seals for use in any place or places outside the Cayman Islands. Each duplicate seal shall be a facsimile of the original seal of the Company. However, if the Directors so determine, a duplicate seal shall have added on its face the name of the place where it is to be used.

### When and how seal is to be used

26.3 A seal may only be used by the authority of the Directors. Unless the Directors otherwise determine, a document to which a seal is affixed must be signed in one of the following ways:

- (a) by a Director (or his/her alternate) and the Secretary; or
- (b) by a single Director (or his/her alternate).

### If no seal is adopted or used

26.4 If the Directors do not adopt a seal, or a seal is not used, a document may be executed in the following manner:

- (a) by a Director (or his/her alternate) or any Officer to which authority has been delegated by resolution duly adopted by the Directors; or
- (b) by a single Director (or his/her alternate); or
- (c) in any other manner permitted by the Act.

### Power to allow non-manual signatures and facsimile printing of seal

26.5 The Directors may determine that either or both of the following applies:

- (a) that the seal or a duplicate seal need not be affixed manually but may be affixed by some other method or system of reproduction;
- (b) that a signature required by these Articles need not be manual but may be a mechanical or Electronic Signature.

### Validity of execution

26.6 If a document is duly executed and delivered by or on behalf of the Company, it shall not be regarded as invalid merely because, at the date of the delivery, the Secretary, or the Director, or other Officer or person who signed the document or affixed the seal for and on behalf of the Company ceased to be the Secretary or hold that office and authority on behalf of the Company.

**27 Indemnity**

- 27.1 To the extent permitted by law, the Company shall indemnify each existing or former Director (including alternate Director), Secretary and other Officer of the Company (including an investment adviser or an administrator or liquidator) and their personal representatives against:
- (a) all actions, proceedings, costs, charges, expenses, losses, damages or liabilities incurred or sustained by the existing or former Director (including alternate Director), Secretary or Officer in or about the conduct of the Company's business or affairs or in the execution or discharge of the existing or former Director's (including alternate Director's), Secretary's or Officer's duties, powers, authorities or discretions; and
  - (b) without limitation to paragraph (a), all costs, expenses, losses or liabilities incurred by the existing or former Director (including alternate Director), Secretary or Officer in defending (whether successfully or otherwise) any civil, criminal, administrative or investigative proceedings (whether threatened, pending or completed) concerning the Company or its affairs in any court or tribunal, whether in the Cayman Islands or elsewhere.

Such indemnity only applies if the Directors are of the view that, in the absence of fraud, wilful default or wilful neglect, an existing or former Director (including alternate Director), Secretary or Officer acted honestly and in good faith with a view to what the person believes is in the best interests of the Company and, in the case of criminal proceedings, such person had no reasonable cause to believe that their conduct was unlawful. No such existing or former Director (including alternate Director), Secretary or Officer, however, shall be indemnified in respect of any matter arising out of his/her own actual fraud, wilful default or wilful neglect.

- 27.2 To the extent permitted by Act, the Company may make a payment, or agree to make a payment, whether by way of advance, loan or otherwise, for any legal costs incurred by an existing or former Director (including alternate Director), Secretary or Officer of the Company in respect of any matter identified in Article 27.1 on condition that the Director (including alternate Director), Secretary or Officer must repay the amount paid by the Company to the extent that it is ultimately found not liable to indemnify the Director (including alternate Director), Secretary or that Officer for those legal costs.

**Release**

- 27.3 To the extent permitted by Act, the Company may by Special Resolution release any existing or former Director (including alternate Director), Secretary or other Officer of the Company from liability for any loss or damage or right to compensation which may arise out of or in connection with the execution or discharge of the duties, powers, authorities or discretions of his/her office; but there may be no release from liability arising out of or in connection with that person's own actual fraud, wilful default or wilful neglect.

**Insurance**

27.4 To the extent permitted by Act, the Company may pay, or agree to pay, a premium in respect of a contract insuring each of the following persons against risks determined by the Directors, other than liability arising out of that person's own dishonesty:

- (a) an existing or former Director (including alternate Director), Secretary or Officer of:
  - (i) the Company;
  - (ii) a company which is or was a subsidiary of the Company;
  - (iii) a company in which the Company has or had an interest (whether direct or indirect); and
- (b) a trustee of an employee or retirement benefits scheme or other trust in which any of the persons referred to in paragraph (a) is or was interested.

**28 Notices****Form of notices**

28.1 Save where these Articles provide otherwise, and subject to the Designated Stock Exchange Rules, any notice to be given to or by any person pursuant to these Articles shall be:

- (a) in writing signed by or on behalf of the giver in the manner set out below for written notices; or
- (b) subject to the next Article, in an Electronic Record signed by or on behalf of the giver by Electronic Signature and authenticated in accordance with Articles about authentication of Electronic Records; or
- (c) where these Articles expressly permit, by the Company by means of a website.

**Electronic communications**

28.2 A notice may only be given to the Company in an Electronic Record if:

- (a) the Directors so resolve;
- (b) the resolution states how an Electronic Record may be given and, if applicable, specifies an email address for the Company; and

- (c) the terms of that resolution are notified to the Members for the time being and, if applicable, to those Directors who were absent from the meeting at which the resolution was passed.

If the resolution is revoked or varied, the revocation or variation shall only become effective when its terms have been similarly notified.

28.3 A notice may not be given by Electronic Record to a person other than the Company unless the recipient has notified the giver of an Electronic address to which notice may be sent.

28.4 Subject to the Act, the Designated Stock Exchange Rules and to any other rules which the Company is bound to follow, the Company may also send any notice or other document pursuant to these Articles to a Member by publishing that notice or other document on a website where:

- (a) the Company and the Member have agreed to his/her/its having access to the notice or document on a website (instead of it being sent to such person);
- (b) the notice or document is one to which that agreement applies;
- (c) the Member is notified (in accordance with any requirements laid down by the Act and, in a manner for the time being agreed between such person and the Company for the purpose) of:
  - (i) the publication of the notice or document on a website;
  - (ii) the address of that website; and
  - (iii) the place on that website where the notice or document may be accessed, and how it may be accessed; and
- (d) the notice or document is published on that website throughout the publication period, provided that, if the notice or document is published on that website for a part, but not all of, the publication period, the notice or document shall be treated as being published throughout that period if the failure to publish that notice or document throughout that period is wholly attributable to circumstances which it would not be reasonable to have expected the Company to prevent or avoid. For the purposes of this Article 28.4 "publication period" means a period of not less than twenty-one days, beginning on the day on which the notification referred to in Article 28.4(c) is deemed sent.

**Validity despite accidental error in publication on website**

28.5 If, for the purpose of a meeting, documents are sent by being published on a website in accordance with the preceding Articles, the proceedings at that meeting are not invalidated merely because:

- (a) those documents are, by accident, published in a different place on the website to the place notified; or
- (b) they are published for part only of the period from the date of notification until the conclusion of that meeting.

**Persons entitled to notices**

28.6 Any notice or other document to be given to a Member may be given by reference to the register of Members as it stands at any time within the period of twenty-one days before the day that the notice is given or (where and as applicable) within any other period permitted by, or in accordance with the requirements of, (to the extent applicable) the Designated Stock Exchange Rules and/or the Designated Stock Exchanges. No change in the register of Members after that time shall invalidate the giving of such notice or document or require the Company to give such item to any other person.

**Persons authorised to give notices**

28.7 A notice by either the Company or a Member pursuant to these Articles may be given on behalf of the Company or a Member by a Director or company secretary of the Company or a Member.

**Delivery of written notices**

28.8 Save where these Articles provide otherwise, a notice in writing may be given personally to the recipient, or left at (as appropriate) the Member's or Director's registered address or the Company's registered office, or posted to that registered address or registered office.

**Joint holders**

28.9 Where Members are joint holders of a Share, all notices shall be given to the Member whose name first appears in the register of Members.

**Signatures**

28.10 A written notice shall be signed when it is autographed by or on behalf of the giver, or is marked in such a way as to indicate its execution or adoption by the giver.

28.11 An Electronic Record may be signed by an Electronic Signature.

**Evidence of transmission**

28.12 A notice given by Electronic Record shall be deemed sent if an Electronic Record is kept demonstrating the time, date and content of the transmission, and if no notification of failure to transmit is received by the giver.

28.13 A notice given in writing shall be deemed sent if the giver can provide proof that the envelope containing the notice was properly addressed, pre-paid and posted, or that the written notice was otherwise properly transmitted to the recipient.

28.14 A Member present, either in person or by proxy, at any meeting of the Company or of the holders of any class of Shares shall be deemed to have received due notice of the meeting and, where requisite, of the purposes for which it was called.

**Giving notice to a deceased or bankrupt Member**

28.15 A notice may be given by the Company to the persons entitled to a Share in consequence of the death or bankruptcy of a Member by sending or delivering it, in any manner authorised by these Articles for the giving of notice to a Member, addressed to them by name, or by the title of representatives of the deceased, or trustee of the bankrupt or by any like description, at the address, if any, supplied for that purpose by the persons claiming to be so entitled.

28.16 Until such an address has been supplied, a notice may be given in any manner in which it might have been given if the death or bankruptcy had not occurred.

**Date of giving notices**

28.17 A notice is given on the date identified in the following table

<b>Method for giving notices</b>	<b>When taken to be given</b>
(A) Personally	At the time and date of delivery
(B) By leaving it at the Member's registered address	At the time and date it was left
(C) By posting it by prepaid post to the street or postal address of that recipient	48 hours after the date it was posted
(D) By Electronic Record (other than publication on a website), to recipient's Electronic address	48 hours after the date it was sent
(E) By publication on a website	24 hours after the date on which the Member is deemed to have been notified of the publication of the notice or document on the website

**Saving provision**

28.18 None of the preceding notice provisions shall derogate from the Articles about the delivery of written resolutions of Directors and written resolutions of Members.

## 29 Authentication of Electronic Records

### Application of Articles

29.1 Without limitation to any other provision of these Articles, any notice, written resolution or other document under these Articles that is sent by Electronic means by a Member, or by the Secretary, or by a Director or other Officer of the Company, shall be deemed to be authentic if either Article 29.2 or Article 29.4 applies.

### Authentication of documents sent by Members by Electronic means

29.2 An Electronic Record of a notice, written resolution or other document sent by Electronic means by or on behalf of one or more Members shall be deemed to be authentic if the following conditions are satisfied:

- (a) the Member or each Member, as the case may be, signed the original document, and for this purpose **Original Document** includes several documents in like form signed by one or more of those Members; and
- (b) the Electronic Record of the Original Document was sent by Electronic means by, or at the direction of, that Member to an address specified in accordance with these Articles for the purpose for which it was sent; and
- (c) Article 29.7 does not apply.

29.3 For example, where a sole Member signs a resolution and sends the Electronic Record of the original resolution, or causes it to be sent, by facsimile transmission to the address in these Articles specified for that purpose, the facsimile copy shall be deemed to be the written resolution of that Member unless Article 29.7 applies.

### Authentication of document sent by the Secretary or Officers of the Company by Electronic means

29.4 An Electronic Record of a notice, written resolution or other document sent by or on behalf of the Secretary or an Officer or Officers of the Company shall be deemed to be authentic if the following conditions are satisfied:

- (a) the Secretary or the Officer or each Officer, as the case may be, signed the original document, and for this purpose **Original Document** includes several documents in like form signed by the Secretary or one or more of those Officers; and
- (b) the Electronic Record of the Original Document was sent by Electronic means by, or at the direction of, the Secretary or that Officer to an address specified in accordance with these Articles for the purpose for which it was sent; and
- (c) Article 29.7 does not apply.

This Article 29.4 applies whether the document is sent by or on behalf of the Secretary or Officer in his/her own right or as a representative of the Company.

- 29.5 For example, where a sole Director signs a resolution and scans the resolution, or causes it to be scanned, as a PDF version which is attached to an email sent to the address in these Articles specified for that purpose, the PDF version shall be deemed to be the written resolution of that Director unless Article 29.7 applies.

**Manner of signing**

- 29.6 For the purposes of these Articles about the authentication of Electronic Records, a document will be taken to be signed if it is signed manually or in any other manner permitted by these Articles.

**Saving provision**

- 29.7 A notice, written resolution or other document under these Articles will not be deemed to be authentic if the recipient, acting reasonably:

- (a) believes that the signature of the signatory has been altered after the signatory had signed the original document; or
- (b) believes that the original document, or the Electronic Record of it, was altered, without the approval of the signatory, after the signatory signed the original document; or
- (c) otherwise doubts the authenticity of the Electronic Record of the document

and the recipient promptly gives notice to the sender setting the grounds of its objection. If the recipient invokes this Article, the sender may seek to establish the authenticity of the Electronic Record in any way the sender thinks fit.

**30 Transfer by way of continuation**

- 30.1 The Company may, by Special Resolution, resolve to be registered by way of continuation in a jurisdiction outside:

- (a) the Cayman Islands; or
- (b) such other jurisdiction in which it is, for the time being, incorporated, registered or existing.

- 30.2 To give effect to any resolution made pursuant to the preceding Article, the Directors may cause the following:

- (a) an application be made to the Registrar of Companies of the Cayman Islands to deregister the Company in the Cayman Islands or in the other jurisdiction in which it is for the time being incorporated, registered or existing; and



(b) all such further steps as they consider appropriate to be taken to effect the transfer by way of continuation of the Company.

### **31 Winding up**

#### **Distribution of assets in specie**

31.1 If the Company is wound up the Members may, subject to these Articles and any other sanction required by the Act, pass a Special Resolution allowing the liquidator to do either or both of the following:

- (a) to divide in specie among the Members the whole or any part of the assets of the Company and, for that purpose, to value any assets and to determine how the division shall be carried out as between the Members or different classes of Members; and/or
- (b) to vest the whole or any part of the assets in trustees for the benefit of Members and those liable to contribute to the winding up.

#### **No obligation to accept liability**

31.2 No Member shall be compelled to accept any assets if an obligation attaches to them.

31.3 The Directors are authorised to present a winding up petition

31.4 The Directors have the authority to present a petition for the winding up of the Company to the Grand Court of the Cayman Islands on behalf of the Company without the sanction of a resolution passed at a General Meeting.

### **32 Amendment of Memorandum and Articles**

#### **Power to change name or amend Memorandum**

32.1 Subject to the Act, the Company may, by Special Resolution:

- (a) change its name; or
- (b) change the provisions of its Memorandum with respect to its objects, powers or any other matter specified in the Memorandum.

#### **Power to amend these Articles**

32.2 Subject to the Act and as provided in these Articles, the Company may, by Special Resolution, amend these Articles in whole or in part.

**33 Mergers and Consolidations**

33.1 The Company shall have the power to merge or consolidate with one or more constituent companies (as defined in the Act) upon such terms as the Directors may determine and (to the extent required by the Act) with the approval of a Special Resolution.

**34 Certain Tax Filings**

34.1 Each Tax Filing Authorised Person and any such other person, acting alone, as any Director shall designate from time to time, are authorised to file tax forms SS-4, W-8 BEN, W-8 IMY, W-9, 8832 and 2553 and such other tax forms as are customary to file with any US state or federal governmental authorities or foreign governmental authorities in connection with the formation, activities and/or elections of the Company and such other tax forms as may be approved from time to time by any Director of the Company or an Officer. The Company further ratifies and approves any such filing made by any Tax Filing Authorised Person or such other person prior to the date of these Articles.

**PART II**

**INFORMATION NOT REQUIRED IN PROSPECTUS**

**Item 20. Indemnification of Directors and Officers**

The laws of the Cayman Islands do not limit the extent to which a company's memorandum and articles of association may provide for indemnification of officers and directors, except to the extent any such provision may be held by the Islands courts to be contrary to public policy, such as to provide indemnification against willful default, willful neglect, civil fraud or the consequences of committing a crime. The Amended PubCo Charter shall provide that every director and officer (but not including the company's auditors) and the personal representatives of the same (each an "Indemnified Person") shall be indemnified and secured harmless out of the assets and funds of our company against all actions, proceedings, costs, charges, expenses, losses, damages or liabilities incurred or sustained by such Indemnified Person, other than by reason of such Indemnified Person's own dishonesty, willful default or fraud as determined by a court of competent jurisdiction, in or about the conduct of our business or affairs (including as a result of any mistake of judgment) or in the execution or discharge of his duties, powers, authorities or discretions, including without prejudice to the generality of the foregoing, any costs, expenses, losses or liabilities incurred by such Indemnified Person in defending (whether successfully or otherwise) any civil proceedings concerning our company or our affairs in any court whether in the Cayman Islands or elsewhere.

We also plan to enter into indemnification agreements with our directors under law, pursuant to which we will agree to indemnify each such person and hold him harmless against expenses, judgments, fines and amounts payable under settlement agreements in connection with any threatened, pending or completed action, suit or proceeding to which he has been made a party or in which he became involved by reason of the fact that he is or was our director or officer. Except with respect to expenses to be reimbursed by us in the event that the indemnified person has been successful on the merits or otherwise in defense of the action, suit or proceeding, our obligations under the indemnification agreements will be subject to certain customary restrictions and exceptions.

In addition, we maintain, and are obligated to establish and maintain for at least six years, standard and tail policies of insurance under which coverage is provided to our directors and officers against loss rising from claims made by reason of breach of duty or other wrongful act, and to us with respect to payments which may be made by us to such directors and officers pursuant to the above indemnification provision or otherwise as a matter of law.

Insofar as indemnification for liabilities arising under the Securities Act may be permitted to directors, officers or persons controlling us pursuant to the foregoing provisions, we have been informed that in the opinion of the SEC such indemnification is against public policy as expressed in the Securities Act and is therefore unenforceable.

## Item 21. Exhibits and Financial Statement Schedules

Exhibit Number	Description
<a href="#">2.1#</a>	<a href="#">Business Combination Agreement dated December 29, 2022, by and among PNAC, Prime Number Merger Sub Inc., Noco-Noco Pte. Ltd., and certain other parties of the agreement, joined by PubCo and New SubCo on February 3, 2022</a>
<a href="#">3.1+</a>	<a href="#">PNAC Amended and Restated Certificate of Incorporation, dated May 10, 2022 (incorporated by reference to Exhibit 3.1 to PNAC's Current Report on Form 8-K filed with the Securities &amp; Exchange Commission on May 18, 2022)</a>
<a href="#">3.2+</a>	<a href="#">PNAC Bylaws (incorporated by reference to Exhibit 3.4 to PNAC's Registration Statement on Form S-1 filed with the Securities &amp; Exchange Commission on May 3, 2022)</a>
<a href="#">3.3</a>	<a href="#">Certificate of Incorporation of PubCo</a>
<a href="#">3.4</a>	<a href="#">Memorandum and Articles of Association of PubCo</a>
<a href="#">3.5</a>	<a href="#">Form of Amended and Restated Memorandum and Articles of Association of PubCo</a>
<a href="#">4.1+</a>	<a href="#">PNAC Specimen Unit Certificate (incorporated by reference to Exhibit 4.1 to PNAC's Registration Statement on Form S-1 filed with the Securities &amp; Exchange Commission on May 3, 2022)</a>
<a href="#">4.2+</a>	<a href="#">PNAC Specimen Common Stock Certificate (incorporated by reference to Exhibit 4.2 to PNAC's Registration Statement on Form S-1 filed with the Securities &amp; Exchange Commission on May 3, 2022)</a>
<a href="#">4.3+</a>	<a href="#">PNAC Specimen Warrant Certificate (incorporated by reference to Exhibit 4.3 to PNAC's Registration Statement on Form S-1 filed with the Securities &amp; Exchange Commission on May 3, 2022)</a>
<a href="#">4.4+</a>	<a href="#">PNAC Specimen Right Certificate (incorporated by reference to Exhibit 4.5 to PNAC's Registration Statement on Form S-1 filed with the Securities &amp; Exchange Commission on May 3, 2022)</a>
<a href="#">4.5+</a>	<a href="#">Warrant Agreement, dated May 12, 2022, between the Registrant and VStock Transfer, LLC, as warrant agent (incorporated by reference to Exhibit 4.1 to PNAC's Current Report on Form 8-K filed with the Securities &amp; Exchange Commission on May 18, 2022)</a>
<a href="#">4.6+</a>	<a href="#">Right Agreement, dated May 12, 2022, between the Registrant and VStock Transfer, LLC, as right agent (incorporated by reference to Exhibit 4.2 to PNAC's Current Report on Form 8-K filed with the Securities &amp; Exchange Commission on May 18, 2022)</a>
<a href="#">4.7#</a>	<a href="#">Form of Warrant Assumption Agreement, between PNAC, PubCo and VStock Transfer, LLC.</a>
<a href="#">4.8#</a>	<a href="#">Form of Notice from PNAC to VStock Transfer, LLC re Warrant Agreement entered between PNAC and VStock Transfer, LLC dated May 12, 2022.</a>
<a href="#">5.1</a>	<a href="#">Form of Opinion of Ogier as to Validity of PubCo Ordinary Shares</a>
<a href="#">5.2#</a>	<a href="#">Form of Opinion of Robinson &amp; Cole LLP as to Validity of PubCo Warrants</a>
<a href="#">8.1#</a>	<a href="#">Form of Opinion of Messina Madrid Law PA re certain U.S. tax matters.</a>
<a href="#">10.1+</a>	<a href="#">Underwriting Agreement, dated May 12, 2022, among the Registrant, and Prime Number Capital, LLC and WestPark Capital, Inc., as representatives of the several underwriters (incorporated by reference to Exhibit 1.1 to PNAC's Current Report on Form 8-K filed with the Securities &amp; Exchange Commission on May 18, 2022)</a>

Exhibit Number	Description
<a href="#">10.2+</a>	<a href="#">Letter Agreement, dated May 12, 2022, among PNAC and certain stockholders (incorporated by reference to Exhibit 10.1 to PNAC's Current Report on Form 8-K filed with the Securities &amp; Exchange Commission on May 18, 2022)</a>
<a href="#">10.3+</a>	<a href="#">Investment Management Trust Agreement, dated May 12, 2022, by and between PNAC and Wilmington Trust, National Association, as trustee, (incorporated by reference to Exhibit 10.2 to PNAC's Current Report on Form 8-K filed with the Securities &amp; Exchange Commission on May 18, 2022)</a>
<a href="#">10.4+</a>	<a href="#">Registration Rights Agreement, dated May 12, 2022, by and between PNAC and certain stockholders (incorporated by reference to Exhibit 10.3 to PNAC's Current Report on Form 8-K filed with the Securities &amp; Exchange Commission on May 18, 2022)</a>
<a href="#">10.5+</a>	<a href="#">Private Placement Shares Purchase Agreement, dated May 12, 2022, by and between PNAC and certain stockholders (incorporated by reference to Exhibit 10.4 to PNAC's Current Report on Form 8-K filed with the Securities &amp; Exchange Commission on May 18, 2022)</a>
<a href="#">10.6+</a>	<a href="#">Form of Indemnity Agreements, dated May 12, 2022, by and between PNAC and each of its directors and officers (incorporated by reference to Exhibit 10.5 to PNAC's Current Report on Form 8-K filed with the Securities &amp; Exchange Commission on May 18, 2022)</a>
<a href="#">10.7+</a>	<a href="#">Administrative Services Agreement, dated May 12, 2022, by and between PNAC and Prime Number Acquisition LLC (incorporated by reference to Exhibit 10.6 to PNAC's Current Report on Form 8-K filed with the Securities &amp; Exchange Commission on May 18, 2022)</a>
<a href="#">10.8+</a>	<a href="#">Securities Assignment Agreement, dated May 12, 2022, among Prime Number Acquisition LLC and certain directors and officers of PNAC (incorporated by reference to Exhibit 10.7 to PNAC's Current Report on Form 8-K filed with the Securities &amp; Exchange Commission on May 18, 2022)</a>
<a href="#">10.9+</a>	<a href="#">Form of Lock-Up Agreement (Exhibit A to the Business Combination Agreement) (incorporated by reference to Exhibit 10.1 to PNAC's Current Report on Form 8-K filed with the Securities &amp; Exchange Commission on December 30, 2022)</a>
<a href="#">10.10+</a>	<a href="#">Form of Registration Rights Agreement (Exhibit B to the Merger Agreement) (incorporated by reference to Exhibit 10.2 to PNAC's Current Report on Form 8-K filed with the Securities &amp; Exchange Commission on December 30, 2022)</a>
<a href="#">10.11#</a>	<a href="#">Letter Agreement, dated October 25, 2022, among PNAC, Prime Number Capital, LLC and WestPark Capital, Inc., in connection with the provision of financial advisory services</a>
<a href="#">10.12#</a>	<a href="#">Letter Agreement, dated October 25, 2022, among PNAC and Prime Number Capital, LLC in connection with the provision of capital market and merger &amp; acquisition advisory services, as amended by Supplemental Agreement, dated January 31, 2022</a>
<a href="#">10.13#</a>	<a href="#">Form of Certificate of Merger (Exhibit D to the Business Combination Agreement)</a>
<a href="#">10.14#</a>	<a href="#">PubCo's 2023 Equity Incentive Plan (Exhibit E to the Business Combination Agreement)</a>
<a href="#">10.15#</a>	<a href="#">Form of Joinder to Business Combination Agreement (Exhibit G to the Business Combination Agreement)</a>
<a href="#">10.16#</a>	<a href="#">Form of Employment Agreement between PubCo and PubCo's executive officers</a>
<a href="#">10.17#</a>	<a href="#">Form of Non-Disclosure, Non-Competition and Non-Solicitation Agreement between PubCo and certain shareholders</a>
<a href="#">10.18#</a>	<a href="#">Form of Indemnification Agreement between PubCo and PubCo's directors</a>
<a href="#">10.19#</a>	<a href="#">Form of Director Service Agreement between PubCo and PubCo's directors</a>
<a href="#">10.20#</a>	<a href="#">Sublicense Agreement, dated November 22, 2022, between 3DOM Alliance Inc. and NOCO-NOCO PTE. LTD.</a>
<a href="#">10.21#</a>	<a href="#">Supplemental Agreement, dated May 10, 2023, between 3DOM Alliance Inc. and NOCO-NOCO PTE. LTD.</a>
<a href="#">10.22#</a>	<a href="#">Promissory Note, dated August 1, 2020, issued from 3DOM Singapore Pte. Ltd., as borrower, to 3DOM, Inc., as holder</a>
<a href="#">10.23#</a>	<a href="#">Amendment to Promissory Note, dated January 23, 2023, issued from 3DOM Singapore Pte. Ltd., as borrower, to 3DOM, Inc., as holder</a>
<a href="#">10.24#</a>	<a href="#">Amendment to Promissory Note, dated February 6, 2023, issued from 3DOM Singapore Pte. Ltd., as borrower, to 3DOM, Inc., as holder</a>
<a href="#">10.25</a>	<a href="#">Placement Agent Agreement, dated April 30, 2023, among PNAC and Prime Number Capital, LLC.</a>
<a href="#">14.1#</a>	<a href="#">Form of Code of Business Conduct and Ethics</a>
<a href="#">19.1#</a>	<a href="#">Form of Insider Trading Policy</a>
<a href="#">21.1#</a>	<a href="#">List of subsidiary of PubCo</a>
<a href="#">23.1</a>	<a href="#">Consent of UHY LLP</a>
<a href="#">23.2</a>	<a href="#">Consent of Marcum Asia CPAs LLP</a>
<a href="#">23.3</a>	<a href="#">Consent of Ogier (included in Exhibit 5.1)</a>
<a href="#">23.4</a>	<a href="#">Consent of Robinson &amp; Cole LLP (included in Exhibit 5.2)</a>
<a href="#">99.1#</a>	<a href="#">Consent of Masataka Matsumura (PubCo's director nominee)</a>
<a href="#">99.2#</a>	<a href="#">Consent of Mari Matsushita (PubCo's director nominee)</a>
<a href="#">99.3#</a>	<a href="#">Consent of Yuta Akakuma (PubCo's director nominee)</a>
<a href="#">99.4#</a>	<a href="#">Consent of Timothy Lai Wah Teo (PubCo's director nominee)</a>
<a href="#">99.5#</a>	<a href="#">Consent of Heizo Takenaka (PubCo's director nominee)</a>
<a href="#">99.6#</a>	<a href="#">Consent of Jean-Francois Raymond Roger Minier (PubCo's director nominee)</a>
<a href="#">99.7#</a>	<a href="#">Consent of Frost &amp; Sullivan Limited</a>
<a href="#">99.8*</a>	<a href="#">Form of Proxy for Special Meeting of Holders of PNAC Common Stock</a>
<a href="#">107#</a>	<a href="#">Filing Fee Table</a>

- \* To be filed
- # Previously filed
- + Previously filed and incorporated by reference

## Item 22. Undertakings

The undersigned registrant hereby undertakes:

- (1) To file, during any period in which offers or sales are being made, a post-effective amendment to this registration statement:
  - i. To include any prospectus required by Section 10(a)(3) of the Securities Act of 1933;
  - ii. To reflect in the prospectus any facts or events arising after the effective date of the registration statement (or the most recent post-effective amendment thereof) which, individually or in the aggregate, represent a fundamental change in the information set forth in the registration statement. Notwithstanding the foregoing, any increase or decrease in volume of securities offered (if the total dollar value of securities offered would not exceed that which was registered) and any deviation from the low or high end of the estimated maximum offering range may be reflected in the form of prospectus filed with the Commission pursuant to Rule 424(b) if, in the aggregate, the changes in volume and price represent no more than 20 percent change in the maximum aggregate offering price set forth in the "Calculation of Registration Fee" table in the effective registration statement.
  - iii. To include any material information with respect to the plan of distribution not previously disclosed in the registration statement or any material change to such information in the registration statement.
- (2) That, for the purpose of determining any liability under the Securities Act of 1933, each such post-effective amendment shall be deemed to be a new registration statement relating to the securities offered therein, and the offering of such securities at that time shall be deemed to be the initial bona fide offering thereof.
- (3) To remove from registration by means of a post-effective amendment any of the securities being registered which remain unsold at the termination of the offering.
- (4) To file a post-effective amendment to the registration statement to include any financial statements required by Item 8.A of Form 20-F at the start of any delayed offering or throughout a continuous offering. Financial statements and information otherwise required by Section 10(a)(3) of the Securities Act need not be furnished, provided that the registrant includes in the prospectus, by means of a post-effective amendment, financial statements required pursuant to this paragraph (4) and other information necessary to ensure that all other information in the prospectus is at least as current as the date of those financial statements.

Insofar as indemnification for liabilities arising under the Securities Act of 1933 may be permitted to directors, officers and controlling persons of the registrant pursuant to the foregoing provisions, or otherwise, the registrant has been advised that in the opinion of the SEC such indemnification is against public policy as expressed in the Act and is, therefore, unenforceable. In the event that a claim for indemnification against such liabilities (other than the payment by the registrant of expenses incurred or paid by a director, officer or controlling person of the registrant in the successful defense of any action, suit or proceeding) is asserted by such director, officer or controlling person in connection with the securities being registered, the registrant will, unless in the opinion of its counsel the matter has been settled by controlling precedent, submit to a court of appropriate jurisdiction the question whether such indemnification by it is against public policy as expressed in the Act and shall be governed by the final adjudication of such issue.

That, for the purpose of determining liability of the registrant under the Securities Act of 1933 to any purchaser in the initial distribution of the securities: The undersigned registrant undertakes that in a primary offering of securities of the undersigned registrant pursuant to this registration statement, regardless of the underwriting method used to sell the securities to the purchaser, if the securities are offered or sold to such purchaser by means of any of the following communications, the undersigned registrant will be a seller to the purchaser and will be considered to offer or sell such securities to such purchaser:

- Any preliminary prospectus or prospectus of the undersigned registrant relating to the offering required to be filed pursuant to Rule 424;
- Any free writing prospectus relating to the offering prepared by or on behalf of the undersigned registrant or used or referred to by the undersigned registrant;
- The portion of any other free writing prospectus relating to the offering containing material information about the undersigned registrant or its securities provided by or on behalf of the undersigned registrant; and
- Any other communication that is an offer in the offering made by the undersigned registrant to the purchaser.

The undersigned registrant hereby undertakes as follows: that prior to any public reoffering of the securities registered hereunder through use of a prospectus which is a part of this registration statement, by any person or party who is deemed to be an underwriter within the meaning of Rule 145(c), the issuer undertakes that such reoffering prospectus shall contain the information called for by the applicable registration form with respect to reofferings by persons who may be deemed underwriters, in addition to the information called for by the other items of the applicable form.

The registrant undertakes that every prospectus: (i) that is filed pursuant to the immediately preceding paragraph, or (ii) that purports to meet the requirements of Section 10(a)(3) of the Act and is used in connection with an offering of securities subject to Rule 415, shall be filed as a part of an amendment to the registration statement and shall not be used until such amendment is effective, and that, for purposes of determining any liability under the Securities Act of 1933, each such post-effective amendment shall be deemed to be a new registration statement relating to the securities offered therein, and the offering of such securities at that time shall be deemed to be the initial bona fide offering thereof.

The undersigned registrant hereby undertakes to respond to requests for information that is incorporated by reference into the prospectus pursuant to Item 4, 10(b), 11, or 13 of this form, within one business day of receipt of such request, and to send the incorporated documents by first class mail or other equally prompt means. This includes information contained in documents filed subsequent to the effective date of the registration statement through the date of responding to the request.

The undersigned registrant hereby undertakes to supply by means of a post-effective amendment all information concerning a transaction, and the company being acquired involved therein, that was not the subject of and included in the registration statement when it became effective.

**SIGNATURES**

Pursuant to the requirements of the Securities Act of 1933, the registrant has duly caused registration statement on Form F-4 to be signed on its behalf by the undersigned, thereunto duly authorized, in the City of Los Angeles, State of California, United States on June 21, 2023.

**Prime Number Holding Limited**

By: /s/ Dongfeng Wang

Name: Dongfeng Wang

Title: Director



**AUTHORIZED REPRESENTATIVE**

Pursuant to the requirement of the Securities Act of 1933, the undersigned, the duly undersigned representative in the United States of Prime Number Holding Limited, has signed this registration statement in the City of New York, State of New York, United States, on June 21, 2023.

Cogency Global Inc.

By: /s/ Colleen A. De Vries

Name: Colleen A. De Vries

Title: Sr. Vice President of Cogency

---

**BUSINESS COMBINATION AGREEMENT**

**by and among**

**Prime Number Acquisition I Corp.,**

**as Acquiror,**

**THE ACQUISITION ENTITIES NAMED HEREIN,**

**as Acquisition Entities,**

**NOCO-NOCO PTE. LTD.,**

**as the Company,**

**and**

**THE SHAREHOLDERS OF THE COMPANY NAMED HEREIN,**

**as the Sellers**

**dated as of December 29, 2022**

---

---

## TABLE OF CONTENTS

	<b>Page</b>
<b>ARTICLE I</b>	
<b>CERTAIN DEFINITIONS</b>	<b>4</b>
Section 1.1.    Definitions	4
Section 1.2.    Other Definitions	17
Section 1.3.    Construction	19
Section 1.4.    Knowledge	19
<b>ARTICLE II</b>	
<b>THE MERGER; MERGER CLOSING</b>	<b>20</b>
Section 2.1.    The Merger	20
Section 2.2.    Effects of the Merger	20
Section 2.3.    Merger Closing; Merger Effective Time	20
Section 2.4.    Effect of Merger on Issued Securities of Acquiror, PubCo and Merger Sub	21
Section 2.5.    Governing Documents of Surviving Corporation	23
Section 2.6.    Directors and Officers of the Surviving Corporation	23
<b>ARTICLE III</b>	
<b>SHARE EXCHANGE</b>	<b>24</b>
Section 3.1.    Exchange of Company Ordinary Shares	24
Section 3.2.    Exchange Consideration	24
Section 3.3.    Share Exchange Closing	24
Section 3.4.    New SubCo Governance	25
Section 3.5.    Transaction Expense Statements	25
<b>ARTICLE IV</b>	
<b>REPRESENTATIONS AND WARRANTIES OF THE SELLERS</b>	<b>26</b>
Section 4.1.    Organization and Standing	26
Section 4.2.    Due Authorization	26
Section 4.3.    Ownership	27
Section 4.4.    No Conflict	27
Section 4.5.    Governmental Authorities; Consents	27

**TABLE OF CONTENTS**  
**(continued)**

	<b>Page</b>
Section 4.6. Litigation	27
Section 4.7. No Additional Representations	28

**ARTICLE V**

**REPRESENTATIONS AND WARRANTIES OF THE COMPANY** **28**

Section 5.1. Company Organization	28
Section 5.2. Subsidiaries	28
Section 5.3. Due Authorization	29
Section 5.4. No Conflict	29
Section 5.5. Governmental Authorities; Consents	30
Section 5.6. Capitalization of the Company	30
Section 5.7. Capitalization of Subsidiaries	31
Section 5.8. Statutory Registers	31
Section 5.9. Financial Statements; Internal Controls	32
Section 5.10. Undisclosed Liabilities	33
Section 5.11. Litigation and Proceedings	33
Section 5.12. Legal Compliance	34
Section 5.13. Contracts; No Defaults	34
Section 5.14. Company Benefit Plans	37
Section 5.15. Labor Relations; Employees	37
Section 5.16. Taxes	39
Section 5.17. Insurance	40
Section 5.18. Licenses	40
Section 5.19. Equipment and Other Tangible Property	41
Section 5.20. Real Property	41
Section 5.21. Intellectual Property	42
Section 5.22. Privacy and Cybersecurity	44
Section 5.23. Environmental Matters	44
Section 5.24. Absence of Changes	45
Section 5.25. Anti-Corruption Compliance	45

**TABLE OF CONTENTS**  
**(continued)**

	<b>Page</b>
Section 5.26. Anti-Money Laundering, Sanctions and International Trade Compliance	45
Section 5.27. Proxy/Registration Statement	46
Section 5.28. Vendors.	46
Section 5.29. Government Contracts	47
Section 5.30. Sufficiency of Assets	47
Section 5.31. Investment Company	47
Section 5.32. Brokers' Fees	47
Section 5.33. No Additional Representations or Warranties	47
Section 5.34. Investigation	47

**ARTICLE VI**

**REPRESENTATIONS AND WARRANTIES OF ACQUIROR** **48**

Section 6.1. Acquiror Organization	48
Section 6.2. Due Authorization	48
Section 6.3. No Conflict	49
Section 6.4. Litigation and Proceedings	49
Section 6.5. SEC Filings	49
Section 6.6. Internal Controls; Listing; Financial Statements	50
Section 6.7. Governmental Authorities; Consents	51
Section 6.8. Trust Account	52
Section 6.9. Investment Company Act; JOBS Act	52
Section 6.10. Absence of Changes	52
Section 6.11. No Undisclosed Liabilities	53
Section 6.12. Capitalization of Acquiror	53
Section 6.13. Brokers' Fees	54
Section 6.14. Indebtedness	54
Section 6.15. Taxes	54
Section 6.16. Business Activities	56
Section 6.17. Nasdaq Stock Market Quotation	56
Section 6.18. Proxy/Registration Statement	57

**TABLE OF CONTENTS**  
**(continued)**

	<b>Page</b>
Section 6.19. Transaction Financing	57
Section 6.20. No Outside Reliance	57
Section 6.21. No Additional Representation or Warranties	58
<b>ARTICLE VII</b>	
<b>REPRESENTATIONS AND WARRANTIES OF THE ACQUISITION ENTITIES</b>	<b>58</b>
Section 7.1. Organization	58
Section 7.2. Due Authorization	58
Section 7.3. No Conflict	59
Section 7.4. Litigation and Proceedings	59
Section 7.5. Governmental Authorities; Consents	60
Section 7.6. Capitalization of Acquisition Entities	60
Section 7.7. Brokers' Fees	60
Section 7.8. Business Activities	60
Section 7.9. Consideration Shares	61
Section 7.10. Foreign Private Issuer and Emerging Growth Company	61
Section 7.11. Investment Company Act	61
Section 7.12. Intended Tax Treatment	61
<b>ARTICLE VIII</b>	
<b>COVENANTS OF THE COMPANY &amp; THE SELLERS</b>	<b>61</b>
Section 8.1. Company Conduct of Business	61
Section 8.2. Inspection	65
Section 8.3. Preparation and Delivery of Additional Company Financial Statements	65
Section 8.4. Alternative Proposals	66
Section 8.5. Exchange Listing	66
Section 8.6. Notice of Developments	66
Section 8.7. No Trading	67
Section 8.8. Support of Share Exchange	67

**TABLE OF CONTENTS**  
**(continued)**

	<b>Page</b>
<b>ARTICLE IX</b>	
<b>COVENANTS OF ACQUIROR PARTIES</b>	<b>67</b>
Section 9.1. Trust Account Proceeds	67
Section 9.2. Nasdaq Listing	68
Section 9.3. No Solicitation	68
Section 9.4. Conduct of Business	68
Section 9.5. Public Filings	70
Section 9.6. Shareholder Litigation	70
Section 9.7. Section 16 Matters	71
Section 9.8. PubCo Equity Plan	71
Section 9.9. PubCo Charter	71
Section 9.10. Support of Share Exchange	71
Section 9.11. Notice of Development	71
Section 9.12. Transaction Financing Efforts	72
<b>ARTICLE X</b>	
<b>JOINT COVENANTS</b>	<b>72</b>
Section 10.1. Regulatory Approvals; Other Filings	72
Section 10.2. Proxy/Registration Statement	73
Section 10.3. Support of Transaction	77
Section 10.4. Public Announcements	77
Section 10.5. Confidential Information	78
Section 10.6. Transfer Taxes	79
Section 10.7. Tax Free Reorganization Matters	80
Section 10.8. Cooperation; Consultation	80
Section 10.9. Transaction Financing	80
Section 10.10. Joining Seller	81
Section 10.11. Key Person Agreements.	81
Section 10.12. Post-Combination Directors and Officers of PubCo	81
Section 10.13. D&O Indemnification and Insurance	82

**TABLE OF CONTENTS**  
**(continued)**

	<b>Page</b>
Section 10.14. Antitrust Laws	83
Section 10.15. Shareholder Litigation	84
<b>ARTICLE XI</b>	
<b>CONDITIONS TO OBLIGATIONS</b>	<b>85</b>
Section 11.1. Conditions of each Party's Obligations	85
Section 11.2. Conditions to Obligations of Acquiror, Merger Sub and PubCo at Merger Closing	86
Section 11.3. Conditions to Obligations of PubCo, New SubCo, the Company and the Sellers at Share Exchange Closing	86
Section 11.4. Additional Conditions to the Obligations of PubCo and New SubCo at Share Exchange Closing.	87
Section 11.5. Additional Conditions to the Obligations of the Company and the Sellers at Share Exchange Closing	87
Section 11.6. Frustration of Conditions	88
<b>ARTICLE XII</b>	
<b>TERMINATION/EFFECTIVENESS</b>	<b>89</b>
Section 12.1. Termination	89
Section 12.2. Effect of Termination	90
<b>ARTICLE XIII</b>	
<b>MISCELLANEOUS</b>	<b>90</b>
Section 13.1. Trust Account Waiver	90
Section 13.2. Waiver	91
Section 13.3. Notices	91
Section 13.4. Assignment	92
Section 13.5. Rights of Third Parties	92
Section 13.6. Expenses	92
Section 13.7. Headings; Counterparts	92
Section 13.8. Electronic Execution of the Agreement and Certain Other Documents	93
Section 13.9. Company Disclosure Letter	93



**TABLE OF CONTENTS**  
**(continued)**

	<b>Page</b>
Section 13.10. Entire Agreement	93
Section 13.11. Amendments	93
Section 13.12. Severability	94
Section 13.13. Governing Law	94
Section 13.14. Jurisdiction; Waiver of Jury Trial	94
Section 13.15. Enforcement	95
Section 13.16. Non-Recourse	95
Section 13.17. Non-Survival of Representations, Warranties and Covenants	95
Section 13.18. New SubCo	96
Section 13.19. PubCo	96

**Annex I** Allocation Schedule

**Exhibits**

Exhibit A Form of Lock-up Agreement
Exhibit B Form of Registration Rights Agreement
Exhibit C Form of Warrant Assumption Agreement
Exhibit D Form of Certificate of Merger
Exhibit E Form of PubCo ESOP
Exhibit F Form of Post-Combination PubCo Charter
Exhibit G Form of BCA Joinder

## **BUSINESS COMBINATION AGREEMENT**

This Business Combination Agreement, dated as of December 29, 2022 (this “Agreement”), is made and entered into by and among Prime Number Acquisition I Corp., a Delaware corporation (“Acquiror”), PubCo (as defined below and upon the delivery of its signature page pursuant to Section 13.19), Prime Number Merger Sub Inc., a Delaware corporation formed to become a wholly-owned subsidiary of PubCo (the “Merger Sub”), New SubCo (as defined below and upon the delivery of its signature page pursuant to Section 13.18), NOCO-NOCO PTE. LTD., a Singapore private company limited by shares, with its Unique Entity Number being 201924194K (the “Company”), and the shareholders of the Company named on Annex I hereto as of the date hereof (each of which is a Company Insider (as defined below), such shareholders, the “Signing Sellers”) and the shareholders of the Company that join this Agreement pursuant to Section 10.10 after the date hereof (such shareholders, the “Joining Sellers”, together with the Signing Sellers, the “Sellers”).

### **RECITALS**

**WHEREAS**, Acquiror is a blank check company incorporated as a Delaware corporation and incorporated for the purpose of effecting a merger, share exchange, asset acquisition, stock purchase, reorganization or similar business combination with one or more businesses;

**WHEREAS**, a Cayman Islands exempted company incorporated for the purpose of making acquisitions and investments, with the objective of acting as the publicly traded holding company for its subsidiaries (“PubCo”), and PubCo will become a party to this Agreement by delivering its signature page to this Agreement pursuant to Section 13.19;

**WHEREAS**, Merger Sub is a newly incorporated Delaware corporation formed to be a wholly-owned by PubCo, and was incorporated for the sole purpose of effectuating the Merger (as defined below);

**WHEREAS**, for the sole purpose of effectuating the Share Exchange (as defined below), PubCo will incorporate a Singapore private company limited by shares that is a direct wholly-owned Subsidiary of PubCo (“New SubCo”), and New SubCo will become a party to this Agreement immediately after its incorporation by delivering its signature page to this Agreement pursuant to Section 13.18;

**WHEREAS**, the parties hereto desire and intend to effect a business combination transaction whereby upon the terms and subject to the conditions of this Agreement, (a) Acquiror shall merge with and into Merger Sub, with Acquiror continuing as the surviving entity (the “Merger”), as a result of which, (i) Acquiror shall become a wholly-owned subsidiary of PubCo and (ii) all of the issued and outstanding securities of Acquiror immediately prior to the Merger Effective Time (as defined below) shall no longer be outstanding and shall automatically be cancelled, in exchange for the right of the holders thereof to receive substantially equivalent securities of PubCo, and (b) New SubCo shall acquire all of the issued and outstanding Company Ordinary Shares (as defined below) from the Sellers, and in exchange, PubCo shall issue to the Sellers certain ordinary shares of PubCo (the “Share Exchange”), in each case, upon the terms and subject to the conditions set forth in this Agreement and in accordance with the provisions of the Delaware General Corporation Law, as amended (the “Delaware Act”) and other applicable laws;

---

**WHEREAS**, each of the parties hereto intends that, for U.S. federal income tax purposes, (i) the Merger qualifies as a “reorganization” within the meaning of Section 368 of the Code (as defined below) and the Treasury Regulations (as defined below) thereunder, (ii) the Share Exchange, together with the Merger, qualifies as a transfer of property described in Section 351 of the Code and the Treasury Regulations thereunder, (iii) this Agreement constitutes a “plan of reorganization” within the meaning of Sections 354, 361 and 368 of the Code and the Treasury Regulations thereunder and (iv) PubCo shall not be treated as a domestic corporation under Section 7874 of the Code and the Treasury Regulations promulgated thereunder (the “Intended Tax Treatment”);

**WHEREAS**, the board of directors of Acquiror has (i) determined that it is advisable for Acquiror to enter into this Agreement and the documents contemplated hereby, (ii) approved the execution and delivery of this Agreement and the documents contemplated hereby and the transactions contemplated hereby and thereby, and (iii) recommended the adoption and approval of this Agreement and the other documents contemplated hereby and the transactions contemplated hereby and thereby by the Acquiror Shareholders (as defined below);

**WHEREAS**, the board of directors of PubCo has (i) determined that it is advisable for PubCo to enter into this Agreement and the documents contemplated hereby, (ii) approved the execution and delivery of this Agreement and the documents contemplated hereby and the transactions contemplated hereby and thereby, and (iii) recommended the adoption and approval of this Agreement and the other documents contemplated hereby and the transactions contemplated hereby and thereby by PubCo’s shareholders;

**WHEREAS**, the board of directors of the Company has (i) determined that it is advisable for the Company to enter into this Agreement and the documents contemplated hereby, (ii) approved the execution and delivery of this Agreement and the documents contemplated hereby and the transactions contemplated hereby and thereby, and (iii) recommended the adoption and approval of this Agreement and the other documents contemplated hereby and the transactions contemplated hereby and thereby by the Company Shareholders;

**WHEREAS**, the board of directors of Merger Sub has (i) determined that it is advisable for Merger Sub to enter into this Agreement and the documents contemplated hereby, (ii) approved the execution and delivery of this Agreement and the documents contemplated hereby and the transactions contemplated hereby and thereby, and (iii) PubCo, as the sole shareholder of Merger Sub has adopted a resolution by written consent approving this Agreement and the documents contemplated hereby and the transactions contemplated hereby and thereby;

**WHEREAS**, the board of directors of New SubCo has (i) determined that it is advisable for New SubCo to enter into this Agreement and the documents contemplated hereby, (ii) approved the execution and delivery of this Agreement and the documents contemplated hereby and the transactions contemplated hereby and thereby, and (iii) PubCo, as the sole shareholder of New SubCo has adopted a resolution by written consent approving this Agreement and the documents contemplated hereby and the transactions contemplated hereby and thereby;

**WHEREAS**, each of the Signing Sellers have duly approved the execution and delivery of this Agreement and the documents contemplated hereby and the transactions contemplated hereby and thereby;

**WHEREAS**, in furtherance of the Merger and in accordance with the terms hereof, Acquiror shall provide an opportunity to its shareholders to have their outstanding Acquiror Common Stock (as defined below) redeemed on the terms and subject to the conditions set forth in this Agreement, and Acquiror's Governing Documents (as defined below) in connection with obtaining the Acquiror Shareholder Approval (as defined below);

**WHEREAS**, prior to the Merger Effective Time, certain Sellers and the Sponsors shall have entered into lock-up agreements with the Acquiror and PubCo substantially in the form attached hereto as Exhibit A (collectively, the "Lock-up Agreements");

**WHEREAS**, prior to the Merger Effective Time, the definitive agreements will have been executed and delivered by the investors in connection with the Transaction Financing (as defined below);

**WHEREAS**, prior to the Share Exchange Closing (as defined below), Acquiror, the Sponsors, PubCo and certain other parties thereto shall have entered into a registration rights agreement substantially in the form attached hereto as Exhibit B (the "Registration Rights Agreement"), which shall be effective as of the Share Exchange Closing;

**WHEREAS**, immediately prior to or upon the Merger Effective Time, PubCo, Acquiror and VStock Transfer, LLC have entered into a Warrant Assumption Agreement in the form attached hereto as Exhibit C (the "Warrant Assumption Agreement"); and

**WHEREAS**, prior to Share Exchange Closing, each of the Company and the Acquiror Parties shall negotiate in good faith and agree on the forms of (i) the non-disclosure, non-competition and non-solicitation agreement in favor of the PubCo and the Company (the "Non-Disclosure, Non-Competition and Non-solicitation Agreement"), and (ii) the standard employment agreement form of the PubCo (the "PubCo Employment Agreement").

**NOW, THEREFORE**, in consideration of the foregoing and the respective representations, warranties, covenants and agreements set forth in this Agreement and intending to be legally bound hereby, Acquiror, PubCo, New SubCo, the Company and the Sellers agree as follows:

ARTICLE I

**CERTAIN DEFINITIONS**

Section 1.1. Definitions. As used herein, the following terms shall have the following meanings:

“Acquiror” has the meaning specified in the Preamble hereto.

“Acquiror Acquisition Proposal” means (i) any Business Combination, in one transaction or a series of transactions, involving Acquiror or any of its current or future controlled affiliates or involving all or a material portion of the assets, equity securities or businesses of Acquiror or its current or future controlled affiliates (whether by merger, consolidation, recapitalization, purchase or issuance of equity securities, purchase of assets, tender offer or otherwise); or (ii) any equity or similar investment in or by Acquiror and/or any of its controlled affiliates, in each case, other than the Transactions.

“Acquiror Class A Common Stock” means each share of Class A common stock, par value \$0.0001 per share, of Acquiror.

“Acquiror Class B Common Stock” means each share of Class B common stock, par value \$0.0001 per share, of Acquiror.

“Acquiror Common Stock” means collectively Acquiror Class A Common Stock and Acquiror Class B Common Stock.

“Acquiror Confidential Information” means all confidential or proprietary documents and information concerning Acquiror or any of its Representatives, excluding any information which, (i) at the time of disclosure by the Company, PubCo, New SubCo, Merger Sub, any Seller or any of their respective Representatives, is generally available publicly and was not disclosed in breach of this Agreement or any other Contract between the Company and Acquiror or (ii) at the time of the disclosure by Acquiror or its Representatives to the Company, PubCo, New SubCo, Merger Sub, any Seller or any of their respective Representatives, was previously known by such receiving party without violation of Law or any confidentiality obligation by the Person receiving such Acquiror Confidential Information.

“Acquiror IPO” means the initial public offering of the Acquiror Units pursuant to the Acquiror IPO Prospectus.

“Acquiror IPO Prospectus” the Registration Statement on Form S-1 (File No. 333-262457) relating to the Acquiror that was declared effective by the SEC on May 12, 2022.

“Acquiror Parties” means the Acquiror and the Acquisition Entities.

“Acquiror Preferred Stock” each share of preferred stock, par value \$0.0001 per share, of Acquiror.

“Acquiror Redemption Price” means a per-share price, payable in cash, equal to a pro rata share of the aggregate amount on deposit in the Trust Account (including any interest earned on the funds held in the Trust Account) (as determined in accordance with Acquiror’s Governing Documents) in connection with the Transaction Proposals.

“Acquiror Rights” means each such right that entitles the holder thereof to receive one-eighth (1/8) of one share of Class A common stock of Acquiror at the closing of a Business Combination (as such term is defined in the Acquiror’s Governing Documents).

“Acquiror Securities” means the Equity Securities of Acquiror.

“Acquiror Share Redemption” means the election of an eligible (as determined in accordance with Acquiror’s Governing Documents) holder of Acquiror Common Stock to redeem all or a portion of the Acquiror Common Stock held by such holder at the Acquiror Redemption Price.

“Acquiror Shareholder Approval” means (a) the approval of the Business Combination, this Agreement and the other Transaction Documents, (b) the approval of the Certificate of Merger and the Merger by special resolution (as defined in the Delaware Act) of the Acquiror’s Shareholders at an Acquiror Shareholders’ Meeting duly called by the Acquiror Board held for such purpose and (c) the approval of any other proposals as the SEC (or staff member thereof) indicates (i) are necessary in its comments to the Proxy/Registration Statement or correspondence related thereto and (ii) are required to be approved by the shareholders of Acquiror in order for the Share Exchange Closing to be consummated, in each case with the requisite number of votes required under the Acquiror’s Governing Documents and all applicable Laws.

“Acquiror Shareholders” means the holders of shares of Acquiror Common Stock as of immediately prior to the Merger Effective Time.

“Acquiror Transaction Expenses” means any out-of-pocket fees and expenses actually payable by Acquiror, PubCo, New SubCo, Merger Sub, any of the Sponsors or its Affiliates (whether or not billed or accrued for) as a result of or in connection with Acquiror’s negotiation, documentation and consummation of the Transactions, including (a) all fees (excluding amounts due to the underwriters of Acquiror IPO with respect to deferred underwriting commissions), costs, expenses, brokerage fees, commissions, finders’ fees and disbursements of financial advisors, investment banks, data room administrators, attorneys, accountants and other advisors and service providers, including consultants and public relations firms, and (b) any and all filing fees to the Governmental Authorities in connection with the Transactions.

“Acquiror Units” means the units of Acquiror issued at Acquiror IPO (including overallotment units acquired by Acquiror underwriter) consisting of one share of Acquiror Class A Common Stock, one-half of Acquiror Warrant, and one Acquiror Right.

“Acquiror Warrants” means one whole redeemable warrant of which one-half (1/2) was included as part of each Acquiror Unit, entitling the holder thereof to purchase one (1) share of Acquiror Class A Common Stock at a purchase price of \$11.50 per share, subject to adjustments as provided for in the Acquiror IPO Prospectus.

“Acquisition Entities” means PubCo, Merger Sub and New SubCo and “Acquisition Entity” means any of them.

“ACRA” means the Singapore Accounting and Corporate Regulatory Authority.

“Action” means any claim, action, suit, audit, examination, assessment, arbitration, mediation or inquiry, or any proceeding or investigation, by or before any Governmental Authority.

“Affiliate” means, with respect to any specified Person, any Person that, directly or indirectly, controls, is controlled by, or is under common control with, such specified Person, whether through one or more intermediaries or otherwise. The term “control” (including the terms “controlling”, “controlled by” and “under common control with”) means the possession, directly or indirectly, of the power to direct or cause the direction of the management and policies of a Person, whether through the ownership of voting securities, by Contract or otherwise.

“Aggregate Merger Consideration” means the sum of all PubCo Equity Securities receivable by Acquiror Shareholders pursuant to Article II.

“Alternative Proposal” means, with respect to the Company and its Subsidiaries, other than the transactions contemplated in connection with the Permitted Activities, Transaction Financing or any transaction relating to backstop financing of the Transactions, (i) any acquisition or purchase by any third party, directly or indirectly, of any shares of any class of outstanding voting or equity securities of the Company or any of its subsidiaries, or any tender offer (including a self-tender) or exchange offer that, if consummated, would result in any third-party beneficially owning any shares of any class of outstanding voting or equity securities of the Company or any of its Subsidiaries, (ii) any merger, acquisition, amalgamation, consolidation, business combination, joint venture or other similar transaction involving the Company or any of its Subsidiaries, the business of which constitutes 15% or more of the net revenues, net income or assets of the Company or any of its subsidiaries, (iii) retaining advisors, selecting underwriters, or otherwise commencing any work in relation to an initial public offering, or resolving to make, or making, any filing or submission for an initial public offering with any stock exchange or regulator or (iv) any liquidation, dissolution, recapitalization, extraordinary dividend or other significant corporate reorganization of the Company or any of its Subsidiaries, the business of which constitutes 15% or more of the net revenues, net income or assets of the Company or any of its Subsidiaries.

“Anti-Bribery Laws” means the anti-bribery and accounting provisions of the Foreign Corrupt Practices Act of 1977, as amended, and all other applicable anti-corruption and bribery Laws (including the U.K. Bribery Act 2010, and any rules or regulations promulgated thereunder or other Laws of other countries implementing the OECD Convention on Combating Bribery of Foreign Officials).

“Anti-Money Laundering Laws” means, the applicable financial recordkeeping and reporting requirements of the Currency and Foreign Transactions Reporting Act of 1970, as amended, the money laundering statutes of all jurisdictions in which the Company or any of its Subsidiaries operates, the rules and regulations thereunder and any related or similar rules, regulations or guidelines, issued, administered or enforced by any relevant Governmental Authority.

“Audited Financial Statements” means the PCAOB Financial Statements delivered pursuant to Section 8.3, and the audited consolidated statement of financial positions and consolidated statements of comprehensive income, changes in equity and cash flows of the Company and its Subsidiaries as of and for the years ended June 30, 2022 and June 30, 2021, together with the auditor’s reports thereon.

“Available Acquiror Cash” means an amount (that is not generated from any borrowing) equal to the sum of (i) the amount of cash available in the Trust Account following the Acquiror Shareholders’ Meeting, after deducting the amount required to satisfy the Acquiror Share Redemption but prior to the payment of any deferred underwriting commissions being held in the Trust Account and the payment of any Company Transaction Expenses or Acquiror Transaction Expenses, plus (ii) the proceeds of Transaction Financing.

“Business Combination” has the meaning set forth in Acquiror’s Governing Documents as in effect on the date hereof.

“Business Day” means a day other than a Saturday, Sunday or other day on which commercial banks in Japan, Singapore, or New York or Governmental Authorities in the Cayman Islands, Delaware or Singapore are authorized or required by Law to close.

“Cayman Companies Act” the Companies Act (as revised) of the Cayman Islands.

“Cayman Registrar” means the Registrar of Companies of the Cayman Islands.

“Code” means the U.S. Internal Revenue Code of 1986, as amended.



“Combination” means the consummation of the Merger Closing and the Share Exchange Closing.

“Company Benefit Plan” means an “employee benefit plan” as defined in Section 3(3) of ERISA or any similar plan subject to laws of a jurisdiction outside of the United States (whether or not subject to ERISA), or any other plan, policy, program, practice, or agreement (including any employment, bonus, incentive or deferred compensation, employee loan, note or pledge agreement, equity or equity-based compensation, severance, retention, supplemental retirement, change in control or similar plan, policy, program, practice or agreement) providing compensation or other benefits to any current or former director, officer, individual consultant, worker or employee, which are maintained, sponsored or contributed to by the Company, or to which the Company or any of the Company’s Subsidiaries is a party or has or may have any liability, and in each case whether or not (i) subject to the Laws of the United States, (ii) in writing or (iii) funded, but excluding in each case any statutory plan, program, practice or arrangement that is required under applicable Law and maintained by any Governmental Authority.

“Company Confidential Information” means all confidential or proprietary documents and information concerning the Company and its Subsidiaries and the Sellers or any of their respective Representatives, furnished in connection with this Agreement or the transactions contemplated hereby, excluding any information which, (i) at the time of disclosure by Acquiror Party or its Representatives, is generally available publicly and was not disclosed in breach of this Agreement or any other Contract between the Company and Acquiror or (ii) at the time of the disclosure by the Company or any Seller or their respective Representatives to Acquiror Party or its Representatives was previously known by such receiving party without violation of Law or any confidentiality obligation by the Person receiving such Company Confidential Information.

“Company Convertible Securities” means any options, warrants or rights to subscribe for or purchase any capital shares of the Company or securities convertible into or exchangeable for, or that otherwise confer on the holder any right to acquire any capital shares of the Company.

“Company Insider” means a holder of Company Ordinary Shares who (i) is a director or executive officer of the Company or (ii) owns in the aggregate at least five percent (5%) of the issued and outstanding share capital of the Company.

“Company Material Adverse Effect” means any event, state of facts, development, circumstance, occurrence or effect (collectively, “Events”) that (i) has had, or would reasonably be expected to have, individually or in the aggregate, a material adverse effect on the business, assets and liabilities, results of operations or financial condition of the Company and its Subsidiaries, taken as a whole or (ii) does or would reasonably be expected to, individually or in the aggregate, prevent or materially adversely affect the ability of the Company to consummate the Transactions; provided, that in no event would any of the following, alone or in combination, be deemed to constitute, or be taken into account in determining whether there has been or will be, an Event under clause (i) of the definition of a “Company Material Adverse Effect”: (a) any change in applicable Laws or FRSs or any interpretation thereof following the date of this Agreement, (b) any change in interest rates or economic, political, business or financial market conditions generally, (c) the taking of any action required to be taken under this Agreement, (d) any natural disaster (including hurricanes, storms, tornados, flooding, earthquakes, volcanic eruptions or similar occurrences), epidemic or pandemic (including any COVID-19 Measures or any change in such COVID-19 Measures or interpretations following the date of this Agreement), acts of nature or change in climate, (e) any acts of terrorism or war, the outbreak or escalation of hostilities, geopolitical conditions, local, national or international political conditions, (f) any failure in and of itself of the Company to meet any projections or forecasts (provided that the exception in this clause (f) shall not prevent or otherwise affect a determination that any Event underlying such failure has resulted in or contributed to a Company Material Adverse Effect except where such Event is otherwise excluded under any of clauses (a) through (e) or clauses (g) through (j) of this definition), (g) any Events generally applicable to the industries or markets in which the Company and its Subsidiaries operate, (h) any action taken by, or at the request of, Acquiror, New SubCo, PubCo or Sponsors, or (i) the announcement of this Agreement and consummation of the Transactions, including any termination of, reduction in or similar adverse impact (but in each case only to the extent attributable to such announcement or consummation) on the Company’s and its Subsidiaries’ relationships, contractual or otherwise, with third parties; provided, further, that in the case of each of clauses (a), (b), (c), (d), (e) and (g), any such Event to the extent such Event disproportionately and adversely affects the business, assets, liabilities, results of operations or condition of the Company and its Subsidiaries, taken as a whole, relative to other similarly situated participants in the industries in which such Persons operate shall not be excluded from and shall be taken into account in the determination of whether there has been, or would reasonably be expected to be, a Company Material Adverse Effect, but only to the extent of the incremental disproportionate effect on the Company and its Subsidiaries, taken as a whole, relative to such similarly situated participants.

“Company Ordinary Shares” means the ordinary shares in the capital of the Company, as defined in the Company’s Governing Documents.

“Company Related Party” means any:

(a) member, shareholder or equity interest holder who, together with its Affiliates, directly or indirectly holds no less than 5% of the total outstanding share capital of the Company or any of its Subsidiaries, or

(b) any director, officer or employee of the Company or any of its Subsidiaries with a title of Director (for the avoidance of doubt such title does not refer to a member of the board of directors) or higher or any immediate family member of the foregoing Persons, in each case of clauses (a) and (b), excluding the Company and any of its Subsidiaries.

“Company Shareholder Approval” means the approval of this Agreement and the transactions contemplated hereby pursuant to the terms and subject to the conditions of the Company’s Governing Documents and applicable Law.

“Company Shareholders” means any holder of any Company Ordinary Shares.

“Company Transaction Expenses” means any out-of-pocket fees and expenses payable by (a) the Company or any of its Subsidiaries or Affiliates (whether or not billed or accrued for) as a result of or in connection with the negotiation, documentation and consummation of the Transactions, including (i) all fees, costs, expenses, brokerage fees, commissions, finders’ fees and disbursements of financial advisors, investment banks, data room administrators, attorneys, accountants and other advisors and service providers, including consultants and public relations firms, (ii) any and all filing fees payable by the Company or any of its Subsidiaries or Affiliates to the Governmental Authorities in connection with the Transactions, and (b) the stamp duty payable by the Sellers in connection with the Share Exchange.

“Contracts” means any legally binding contracts, agreements, subcontracts, leases, and purchase orders.

“Copyright License” means any license that requires, as a condition of use, modification and/or distribution of software subject to such license, that such software subject to such license, or other software incorporated into, derived from, or used or distributed with such software subject to such license (i) in the case of software, be made available or distributed in a form other than binary (e.g., source code form), (ii) be licensed for the purpose of preparing derivative works, (iii) be licensed under terms that allow the Company’s or any Subsidiary of the Company’s products or portions thereof or interfaces therefor to be reverse engineered, reverse assembled or disassembled (other than by operation of Law) or (iv) be redistributable at no license fee. Copyright Licenses include the GNU General Public License, the GNU Lesser General Public License, the Mozilla Public License, the Common Development and Distribution License, the Eclipse Public License and all Creative Commons “share alike” licenses.

“COVID-19” means SARS-CoV-2 or COVID-19.

“COVID-19 Measures” means any quarantine, “shelter in place,” “stay at home,” social distancing, closure, sequester, safety or similar Law, direction or guidelines promulgated by any Governmental Authority, including the Singapore Ministry of Health, the Japan Ministry of Health, Labor and Welfare, U.S. Centers for Disease Control and Prevention or the World Health Organization, in each case, arising following the date hereof in connection with or in response to COVID-19 for similarly situated companies.

“Dollars” or “\$” means lawful money of the United States.

“DTC” means Depository Trust Company.

“Environmental Laws” means any and all applicable Laws relating to Hazardous Material, pollution, or the protection or management of the environment or natural resources, or protection of human health (with respect to exposure to Hazardous Material).

“Equity Securities” means, with respect to any Person, any capital stock, equity interests, membership interests, partnership interests or registered capital, joint venture or other ownership interests in such person and any options, warrants or other securities (for the avoidance of doubt, including debt securities) that are directly or indirectly convertible into, or exercisable or exchangeable for, such capital stock, equity interests, membership interests, partnership interests or registered capital, joint venture or other ownership interests (whether or not such derivative securities are issued by such Person).

“ERISA” means the Employee Retirement Income Security Act of 1974.

“Exchange Act” means the Securities Exchange Act of 1934, as amended.

“FRSs” means the Financial Reporting Standards in Singapore, as in effect from time to time.

“GAAP” means generally accepted accounting principles in the United States as in effect from time to time.

“Governing Documents” means the legal document(s) by which any Person (other than an individual) establishes its legal existence, or which govern its internal affairs, including the articles of incorporation, certificate of incorporation, memorandum of association, articles of association, bylaws, articles of organization, certificate of formation, limited liability company agreement, operating agreement, or similar or other constitutive, governing, or charter documents, or equivalent documents, of such Person.

“Government Official” means any officer, cadre, civil servant, employee or any other person acting in an official capacity for any Governmental Authority (including any political party or official thereof), any candidate for political office, or any employee of a government owned or controlled entity.

“Governmental Authority” means any federal, state, provincial, municipal, local or foreign government, governmental authority, taxing, regulatory or administrative agency, governmental commission, department, board, bureau, agency or instrumentality, court or tribunal.

“Governmental Authorization” means any consent, waiver, approval or authorization of, or designation, declaration or filing with, or notification to, any Governmental Authority.

“Governmental Order” means any order, judgment, injunction, decree, writ, stipulation, determination or award, in each case, entered by or with any Governmental Authority.

“Group Company” means the Company and its Subsidiaries listed on Section 5.2 of the Company Disclosure Letter

“Hazardous Material” means any (i) pollutant, contaminant, chemical, (ii) industrial, solid, liquid or gaseous toxic or hazardous substance, material or waste, (iii) petroleum or any fraction or product thereof, (iv) asbestos or asbestos-containing material, (v) polychlorinated biphenyl, (vi) chlorofluorocarbons, or (vii) other substance, material or waste, in each case, which are regulated under any Environmental Law or as to which liability may be imposed pursuant to Environmental Law.

“Indebtedness” means with respect to any Person, without duplication, any obligations, contingent or otherwise, in respect of (a) the principal of and premium (if any) in respect of all indebtedness for borrowed money, including accrued interest and any per diem interest accruals, (b) the principal and interest components of capitalized lease obligations under FRSs (with respect to the Company) or GAAP (with respect to Acquiror), (c) amounts drawn (including any accrued and unpaid interest) on letters of credit, bank guarantees, bankers’ acceptances and other similar instruments (solely to the extent such amounts have actually been drawn), (d) the principal of and premium (if any) in respect of obligations evidenced by bonds, debentures, notes and similar instruments, (e) the termination value of interest rate protection agreements and currency obligation swaps, hedges or similar arrangements (without duplication of other indebtedness supported or guaranteed thereby), (f) the principal component of all obligations to pay the deferred and unpaid purchase price of property and equipment which have been delivered, including “earn outs” and “seller notes” and (g) breakage costs, upfront payments or early termination premiums, penalties, or other fees or expenses payable as a result of the consummation of the transactions contemplated hereby in respect of any of the items in the foregoing clauses (a) through (f), and (h) all Indebtedness of another Person referred to in clauses (a) through (g) above guaranteed directly or indirectly, jointly or severally.

“Intellectual Property” means any rights in or to intellectual property of any type or nature, throughout the world, including all: (i) patents, patent applications, invention disclosures, and all related continuations, continuations-in-part, divisionals, reissues, re-examinations, substitutions, and extensions thereof; (ii) registered and unregistered trademarks, logos, service marks, trade dress and trade names, slogans, pending applications therefor, and internet domain names and social media handles, together with the goodwill of the Company or any of its Subsidiaries or their respective businesses symbolized by or associated with any of the foregoing; (iii) registered and unregistered copyrights, and applications for registration of copyright, including such corresponding rights in software and other works of authorship; and (iv) trade secrets, know-how, processes, and other confidential information or proprietary rights.

“International Trade Laws” means all export, import, customs, anti-boycott, and other trade Laws or programs administered, enacted or enforced by any relevant Governmental Authority, including but not limited to: (a) the U.S. Export Administration Regulations, the U.S. International Traffic in Arms Regulations, and the import Laws and regulations administered by U.S. Customs and Border Protection; (b) the anti-boycott Laws administered by the U.S. Departments of Commerce and Treasury; and (c) any other similar export, import, customs, anti-boycott, or other trade Laws or programs in any relevant jurisdiction to the extent they are applicable to the Company or any of its Subsidiaries.

“Investment Company Act” means the Investment Company Act of 1940, as amended.

“Key Person Agreements” means the Contracts described in Section 10.11.

“JOBS Act” means the Jumpstart Our Business Startups Act of 2012, as amended.

“Law” means any statute, law, ordinance, rule, regulation or Governmental Order, in each case, of any Governmental Authority.

“Leased Real Property” means all real property leased, licensed, subleased or otherwise used or occupied by the Company or any of its Subsidiaries.

“Licenses” means any approvals, authorizations, consents, licenses, registrations, permits or certificates of a Governmental Authority.

“Lien” means all liens, mortgages, deeds of trust, pledges, hypothecations, encumbrances, security interests, adverse claim, options, rights of pre-emption, leases, subleases, licenses, restrictions, claims or other liens of any kind whether consensual, statutory or otherwise.

“Long Stop Date” means May 16, 2023, or such a later date which Acquiror is permitted to consummate a Business Combination (as defined in Acquiror’s Governing Documents) in accordance with its Governing Documents.

“Open Source License” means any license meeting the Open Source Definition (as promulgated by the Open Source Initiative) or the Free Software Definition (as promulgated by the Free Software Foundation), or any substantially similar license, including any license approved by the Open Source Initiative or any Creative Commons License. “Open Source Licenses” shall include Copyleft Licenses.

“Open Source Materials” means any software subject to an Open Source License.

“PCAOB” means the U.S. Public Company Accounting Oversight Board.

“Permitted Activities” means any minority investment in or secondary share transfers involving less than 2.5% of the voting power and economic interest of the Company.

“Permitted Activities Documents” means all transaction documents in connection with the Permitted Activities.

“Permitted Liens” means (i) mechanic’s, materialmen’s and similar Liens arising in the ordinary course of business with respect to any amounts (A) not yet due and payable or which are being contested in good faith through appropriate proceedings and (B) for which adequate accruals or reserves have been established in accordance with FRSs, (ii) Liens for Taxes (A) not yet due and payable or (B) which are being contested in good faith through appropriate proceedings and for which adequate accruals or reserves have been established in accordance with FRSs (with respect to the Company) or GAAP (with respect to Acquiror), (iii) defects or imperfections of title, easements, encroachments, covenants, rights-of-way, conditions, matters that would be apparent from a physical inspection or current, accurate survey of such real property, restrictions and other similar charges or encumbrances that do not, in the aggregate, materially impair the value or materially interfere with the use of the Leased Real Property, (iv) with respect to any Leased Real Property (A) the interests and rights of the respective lessors with respect thereto, including any statutory landlord liens and any Lien thereon, (B) any Lien permitted under a Real Property Lease, and (C) any Liens encumbering the underlying fee title of the real property of which the Leased Real Property is a part, (v) zoning, building, entitlement and other land use and environmental regulations promulgated by any Governmental Authority that do not, in the aggregate, materially interfere with the current use of, or materially impair the value of, the Leased Real Property, (vi) non-exclusive licenses of Intellectual Property entered into in the ordinary course of business consistent with past practice, (vii) ordinary course purchase money Liens and Liens securing rental payments under operating or capital lease arrangements for amounts not yet due or payable, (viii) other Liens arising in the ordinary course of business consistent with past practice with respect to the borrowing of money in connection with workers’ compensation, unemployment insurance or other types of social security, (ix) reversionary rights in favor of landlords under any Leased Real Property with respect to any of the buildings or other improvements owned by the Company or any of its Subsidiaries, and (x) other Liens incurred in the ordinary course of business consistent with past practice that do not, individually or in the aggregate, materially and adversely affect the use of the property affected by such Lien, or materially disrupt, the ordinary course operation of the businesses of the Company and its Subsidiaries, taken as a whole.

“Person” means any individual, firm, corporation, partnership, limited liability company, incorporated or unincorporated association, joint venture, joint stock company, Governmental Authority or instrumentality or other entity of any kind.

“Pro Rata Portion” with respect to any Seller at any determination date, means the number of Company Ordinary Shares held by such Seller divided by the total number of Company Ordinary Shares held by all Sellers.

“Purchased Shares” means, as of any reference date, all of the issued and outstanding ordinary shares of the Company, which means 325,332 ordinary shares of the Company as of the date hereof.

“PubCo Ordinary Shares” means the ordinary shares of US\$0.0001 par value each of PubCo.

“PubCo Per Share Price” means the price per PubCo Ordinary Share that equals to the redemption price of each share of Class A Common Stock of Acquiror in connection with the Business Combination, which shall be no less than the par value of PubCo Ordinary Shares.

“PubCo Securities” means the Equity Securities in the capital of PubCo.

“PubCo Warrant” means entitling the holder thereof to purchase one (1) PubCo Ordinary Share at a purchase price of \$11.50 per share.

“Representatives” of a Person means, collectively, officers, directors, employees, accountants, consultants, legal counsel, advisors, agents and other representatives of such Person or its Affiliates.

“Restricted Person” means any Person identified on the U.S. Department of Commerce’s Denied Persons List, Unverified List or Entity List or the U.S. Department of State’s Debarred List.

“Sanctioned Jurisdiction” means any country or territory subject to comprehensive Sanctions (at the time of this Agreement, are the so-called Donetsk People’s Republic, the so-called Luhansk People’s Republic, Cuba, Iran, North Korea, Syria and the Crimea region of Ukraine and Sevastopol).

“Sanctioned Person” means any Person that is (a) organized under the Laws of, or resident or located in, any Sanctioned Jurisdiction, (b) included on any list of Persons subject to Sanctions (including, but not limited to, the U.S. Department of Treasury’s Specially Designated Nationals and Blocked Persons List and the Sectoral Sanctions Identification List; or any similar list maintained or administered by the United Nations Security Council, HM Treasury of the United Kingdom, the European Union, any European Union member state, or any other Governmental Authority where the Company or any of its Subsidiaries operates), or (c) owned fifty percent (50%) or more, directly or indirectly, controlled by, or acting on behalf or at the direction of any Person or Persons described in clauses (a) or (b).

“Sanctions” means those trade, economic and financial sanctions Laws, embargoes, and restrictive measures administered, enacted or enforced from time to time by (a) the United States (including through the Department of the Treasury’s Office of Foreign Assets Control or the Department of State), (b) the European Union or any European Union member state, (c) the United Nations Security Council, (d) Her Majesty’s Treasury of the United Kingdom, or (e) any other Governmental Authority where the Company or any of its Subsidiaries operates.

“Sarbanes-Oxley Act” means the Sarbanes-Oxley Act of 2002.

“SEC” means the United States Securities and Exchange Commission.



“Securities Act” means the Securities Act of 1933, as amended.

“Sponsors” means collectively Prime Number Acquisition LLC and Glorious Capital LLC, and “Sponsor” means either of them.

“Subsidiary” means, with respect to a Person, a corporation or other entity of which more than fifty percent (50%) of the voting power of the Equity Securities or equity interests is owned, directly or indirectly, by such Person and, in case of a limited partnership, limited liability company or similar entity, such Person is a general partner or managing member or has the power to direct the policies, management and affairs of such entity, and a subsidiary is a “wholly-owned Subsidiary” of such Person when substantially all of the voting power of its Equity Securities or equity interests is owned or controlled by such Person.

“Target Valuation” means \$1,350,000,000.

“Tax Return” means any return, declaration, report, statement, information statement or other document filed or required to be filed with any Governmental Authority with respect to Taxes, including any claims for refunds of Taxes, any information returns and any schedules, attachments, amendments or supplements of any of the foregoing.

“Taxes” means any and all federal, state, local, foreign or other taxes imposed by any Governmental Authority, including all income, gross receipts, license, payroll, recapture, net worth, employment, escheat and unclaimed property obligations, excise, severance, stamp, occupation, premium, windfall profits, environmental, customs duties, Equity Securities, ad valorem, value added, inventory, franchise, profits, withholding, social security (or similar), unemployment, disability, real property, personal property, sales, use, transfer, registration, governmental charges, duties, levies and other similar charges imposed by a Governmental Authority in the nature of a tax, alternative or add-on minimum, or estimated taxes, and including any interest, penalty, or addition relating thereto.

“Transaction Documents” means, collectively, this Agreement, the Certificate of Merger, the Post-Combination PubCo Charter, the New SubCo Charter, the Lock-up Agreements, the Subscription Agreements, the Registration Rights Agreement, the Warrant Assignment, Assumption and Amendment Agreement, the Key Person Agreements and any other agreements, documents or certificates entered into or delivered pursuant hereto or thereto, and the expression “Transaction Document” means any one of them.

“Transaction Financing Agreements” means such Contracts between Acquiror and PubCo with investors, in a form and with terms acceptable to Acquiror and the Company, pursuant to which the investors thereunder commit to acquiring PubCo Securities or Equity Securities of Acquiror to be converted into PubCo Securities prior to or upon the Share Exchange, with the form of such Equity Securities to be agreed by the Company and Acquiror.

“Transactions” means, collectively, the Merger, the Share Exchange and each of the other transactions contemplated by this Agreement or any of the other Transaction Documents.

“Treasury Regulations” means the regulations promulgated under the Code by the United States Department of the Treasury (whether in final, proposed or temporary form), as the same may be amended from time to time.

“Warrant Agreement” means the Warrant Agreement, dated as of May 12, 2022 between Acquiror and VStock Transfer, LLC, as warrant agent.

“Working Capital Loans” means any loan made to Acquiror by any of the Sponsors, an Affiliate of the Sponsors, or any of Acquiror’s officers or directors, and evidenced by a promissory note, loan agreement or similar document, for the purpose of financing costs, expenses, extension related costs and deposits and other obligations incurred by Acquiror for the Transactions.

## Section 1.2. Other Definitions

Acquiror	Preamble
Acquiror Board	Section 10.2(b)(iii)
Acquiror Board Recommendation	Section 10.2(b)(iii)
Acquiror Cure Period	Section 12.1(e)
Acquiror Disclosure Letter	Article VI
Acquiror Financial Statements	Section 6.6(c)
Acquiror Indemnified Parties	Section 10.13(a)
Acquiror SEC Filings	Section 6.5
Acquiror Shareholders’ Meeting	Section 10.2(b)(i)
Acquiror Transaction Expense Statement	Section 3.5
Allocation Schedule	Section 3.2
Aggregate Exchange Consideration Agreement	Section 3.2
Antitrust Laws	Preamble
Audited Financial Statements	Section 10.14
BCA Joinder	Section 5.9(a)
Certificate of Merger	Section 10.10
Closing Filing	Section 2.3(b)
Closing Press Release	Section 10.4(b)
Company	Section 10.4(b)
Company Board	Preamble
Company Board Recommendation	Section 10.2(c)(ii)
Company Cure Period	Section 10.2(c)(ii)
Company Disclosure Letter	Section 12.1(d)
Company Indemnified Parties	Article V
Company Registered Intellectual Property	Section 10.13(a)
	Section 5.21(a)

Company Shareholders' Meeting	Section 10.2(c)(i)
Company Shareholders' Written Resolution	Section 10.2(c)(i)
Company Share Certificates	Section 3.3(c)
Company Transaction Expense Statement	Section 3.5
Delaware Act	Recitals
D&O Indemnified Parties	Section 10.13(a)
Exchange Consideration	Section 3.2
Intended Tax Treatment	Recitals
Interim Financial Statements	Section 5.9(a)
Interim Financial Statements Date	Section 5.9(a)
Interim Period	Section 8.1
IPO	Section 13.1
Joining Sellers	Preamble
Legal Proceedings	Section 5.11
Lock-up Agreements	Recitals
Material Contracts	Section 5.13(a)
Material In-Licenses	Section 5.13(a)(x)
Merger	Recitals
Merger Closing	Section 2.3(a)
Merger Closing Date	Section 2.3(a)
Merger Effective Time	Section 2.3(b)
Merger Sub	Preamble
Nasdaq	Section 6.17
New SubCo	Recitals
New SubCo Charter	Section 3.4(a)
Non-Disclosure, Non-Competition and Non-Solicitation Agreement	Recitals
Non-Recourse Parties	Section 13.16(b)
PCAOB Financial Statements	Section 8.3(a)
Proxy/Registration Statement	Section 10.2(a)(i)
Post-Combination PubCo Charter	Section 9.9
PubCo	Recital
PubCo ESOP	Section 9.8
PubCo Employment Agreement	Recitals
Public Shareholders	Section 13.1
Real Property Leases	Section 5.20(b)
Registration Rights Agreement	Recitals
Regulatory Approvals	Section 10.1(a)
Related Party Agreements	Section 5.13(a)(vi)
Released Claims	Section 13.1
restraint	Section 11.1(e)
Sellers	Preamble
Share Exchange	Recitals

Share Exchange Closing	Section 3.3(a)
Share Exchange Closing Date	Section 3.3(a)
share exchange restraint	Section 11.3(d)
Signing Filing	Section 10.4(b)
Signing Press Release	Section 10.4(b)
Signing Sellers	Preamble
Singapore Companies Act	Section 3.4(a)
Surviving Corporation	Section 2.1
Terminating Acquiror Breach	Section 12.1(e)
Terminating Company Breach	Section 12.1(d)
Top Vendors	Section 5.28(a)
Transaction Financing	Section 9.12
Transaction Proposals	Section 10.2(a)(i)
Transaction Expense Statements	Section 3.5
Transfer Taxes	Section 10.6
Trust Account	Section 13.1
Trust Agreement	Section 6.8
Trustee	Section 6.8
Warrant Assignment, Assumption and Amendment Agreement	Recitals

Section 1.3. Construction.

(a) Unless the context of this Agreement otherwise requires, (i) words of any gender include each other gender; (ii) words using the singular or plural number also include the plural or singular number, respectively; (iii) the terms “hereof,” “herein,” “hereby,” “hereto” and derivative or similar words refer to this entire Agreement; (iv) the terms “Article” or “Section” refer to the specified Article or Section of this Agreement; (v) the word “including” shall mean “including, without limitation” and (vi) the word “or” shall be disjunctive but not exclusive.

(b) Unless the context of this Agreement otherwise requires, references to statutes shall include all regulations promulgated thereunder and references to statutes or regulations shall be construed as including all statutory and regulatory provisions consolidating, amending or replacing the statute or regulation.

(c) Whenever this Agreement refers to a number of days, such number shall refer to calendar days unless Business Days are specified.

(d) All accounting terms used herein and not expressly defined herein shall have the meanings given to them under GAAP.

Section 1.4. Knowledge. As used herein, the phrase “to the knowledge” of the Company shall mean the actual knowledge of the individuals identified on Section 1.4 of the Company Disclosure Letter, and the knowledge that such individuals would have acquired in the exercise of reasonable inquiries of direct reports; the phrase “to the knowledge” of any Acquiror Party shall mean the actual knowledge of the officers of any Acquiror Party and the knowledge that such individuals would have acquired after reasonable inquiry or investigation.

## ARTICLE II

### **THE MERGER; MERGER CLOSING**

Section 2.1. The Merger. Upon the terms and subject to the conditions set forth in this Agreement and in accordance with the applicable provisions of the Delaware Act, Acquiror and Merger Sub shall consummate the Merger, pursuant to which Merger Sub shall be merged with and into Acquiror, with Acquiror being the surviving entity, following which the separate corporate existence of Merger Sub shall cease and Acquiror shall continue as the surviving corporation in the Merger. Acquiror, as the surviving corporation following the Merger, is hereinafter sometimes referred to as the "Surviving Corporation" (provided, that references to Acquiror for periods after the Merger Effective Time shall include the Surviving Corporation).

Section 2.2. Effects of the Merger. At the Merger Effective Time, the effect of the Merger shall be as provided in this Agreement, the Certificate of Merger and the applicable provisions of the Delaware Act. Without limiting the generality of the foregoing, and subject thereto, at the Merger Effective Time, all the property, rights, privileges, agreements, powers and franchises, debts, Liabilities, immunities, duties and obligations of Merger Sub and Acquiror shall become the property, rights, privileges, agreements, powers and franchises, debts, Liabilities, immunities, duties and obligations of the Surviving Corporation (including all rights and obligations with respect to the Trust Account), which shall include the assumption by the Surviving Corporation of any and all agreements, covenants, duties and obligations of Merger Sub and Acquiror set forth in this Agreement to be performed after the Merger Effective Time, and the Surviving Corporation shall continue its existence as a wholly-owned Subsidiary of PubCo.

Section 2.3. Merger Closing; Merger Effective Time.

(a) In accordance with the terms and subject to the conditions of this Agreement, the closing of the Merger (the "Merger Closing") shall take place remotely by conference call and exchange of documents and signatures on the date which is no later than five (5) Business Days after the first date on which all conditions set forth in Section 11.1 and Section 11.2 shall have been satisfied or waived (other than those conditions that by their terms are to be satisfied at the Merger Closing, but subject to the satisfaction or waiver thereof) or such other time and place as Acquiror and the Company may mutually agree in writing. The date on which the Merger Closing actually occurs is referred to in this Agreement as the "Merger Closing Date".

(b) Subject to the satisfaction or waiver of all of the conditions set forth in Section 11.1 and Section 11.2, Acquiror and Merger Sub shall cause the Merger to be consummated by filing a certificate of merger for the Merger of Acquiror with and into Merger Sub in the form attached hereto as Exhibit D (the "Certificate of Merger"), with Acquiror being the surviving entity in the Merger, with the Secretary of State of the State of Delaware, in accordance with the relevant provisions of the Delaware Act (the time of the Certificate of Merger being accepted by the Secretary of State of the State of Delaware, or such later time as may be specified in the Certificate of Merger, being referred to herein as the "Merger Effective Time").

Section 2.4. Effect of Merger on Issued Securities of Acquiror, PubCo and Merger Sub At the Merger Effective Time, by virtue of the Merger and without any action on the part of any party or the holders of securities of Acquiror, the Company, PubCo or Merger Sub (other than those as described in this Agreement):

(a) *Acquiror Units.* Each Acquiror Unit outstanding immediately prior to the Merger Effective Time shall be automatically detached and the holder thereof shall be deemed to hold one share of Class A common stock of Acquiror, one-half of Acquiror Public Warrant, and one Acquiror Right in accordance with the terms of the applicable Acquiror Unit, which underlying Acquiror Securities shall be converted in accordance with the applicable terms of this Section 2.4 below.

(b) *Acquiror Common Stock.* Each share of Acquiror Common Stock issued and outstanding immediately prior to the Merger Effective Time (other than those described in Section 2.4(d) below) shall automatically be converted into the right to receive one PubCo Ordinary Share, following which all such shares of Acquiror Common Stock shall cease to be outstanding and shall automatically be canceled and shall cease to exist. Each certificate formerly representing shares of Acquiror Common Stock (other than those described in Section 2.4(d) below) shall thereafter represent only the right to receive the same number of PubCo Ordinary Shares.

(c) *Appraisal and Dissenters' Rights.* To the extent required by Section 262 of the Delaware Act, each certificate formerly representing Acquiror Common Stock owned by holders thereof who have validly elected to dissent from the Merger pursuant to Section 262 of the Delaware Act shall thereafter only represent the right to receive fair value for their Acquiror Common Stock in accordance with the applicable provisions of the Delaware Act, and notwithstanding any provision of this Agreement to the contrary and to the extent available under the Delaware Act, shares of Acquiror Common Stock that are outstanding immediately prior to the Merger Effective Time and that are held by holders thereof who shall have neither voted in favor of the Merger nor consented thereto in writing and who shall have demanded properly in writing appraisal or dissenters' rights for such Acquiror Common Stock in accordance with Section 262 of the Delaware Act, and otherwise complied with all of the provisions of the Delaware Act relevant to the exercise and perfection of appraisal rights, shall not be converted into, and such holders shall have no right to receive, the applicable per share Merger consideration unless and until such holder fails to perfect or withdraws or otherwise loses his, her or its right to appraisal and payment under the Delaware Act. Any holder of Acquiror Common Stock who fails to perfect or who effectively withdraws or otherwise loses his, her or its rights to appraisal of such Acquiror Common Stock under Section 262 of the Delaware Act, shall thereupon be deemed to have been converted into, and to have become exchangeable for, as of the Merger Effective Time, the right to receive the applicable per share Merger consideration, without any interest thereon, upon surrender, if applicable, in the manner provided in this Section 2.4, of the certificate or certificates that formerly evidenced such Acquiror Common Stock.

(d) *Cancellation of Capital Stock Owned by Acquiror.* If there are any shares of capital stock of Acquiror that are owned by Acquiror as treasury shares immediately prior to the Merger Effective Time, such shares shall be canceled and extinguished without any conversion thereof or payment therefor.

(e) *Acquiror Warrants.* Each Acquiror Warrant outstanding immediately prior to the Merger Effective Time shall be automatically converted into the right to receive one PubCo Public Warrant, and all Acquiror Warrants shall thereupon cease to be outstanding and shall automatically be canceled and retired and shall cease to exist. Each of the PubCo Warrants shall have, and be subject to, substantially the same terms and conditions set forth in the Acquiror Warrants, except that they shall represent the right to acquire PubCo Ordinary Shares in lieu of shares of Acquiror Common Stock and shall otherwise be amended in accordance with the provisions of the Warrant Assignment and Assumption Amendment Agreement to (among other things) comply with all applicable Laws. At or prior to the Merger Effective Time, PubCo shall take all corporate action necessary to reserve for future issuance, and shall maintain such reservation for so long as any of the PubCo Warrants remain outstanding, a sufficient number of PubCo Ordinary Shares for delivery upon the exercise of such PubCo Warrants.

(f) *Acquiror Rights.* Each Acquiror Right issued and outstanding immediately prior to the Merger Effective Time, shall be automatically converted into the right to receive one-eighth (1/8) of one PubCo Ordinary Share, following which all Acquiror Rights shall cease to be outstanding and shall automatically be canceled and shall cease to exist. At or prior to the Merger Effective Time, PubCo shall have taken all corporate action necessary for issuance of the PubCo Ordinary Shares to the holder of the Acquiror Rights at the Share Exchange Closing.

(g) *Purchase and Cancellation of Issued Shares of PubCo.* The sole holder or holders of shares of PubCo issued and outstanding immediately prior to the Merger Effective Time shall, immediately after the Merger Effective Time, sell, transfer and convey all such shares to PubCo for an aggregate of \$0.01 and PubCo shall have taken all corporate action necessary to repurchase such shares, which shares shall thereupon be canceled by PubCo.

(h) *Cancellation of Shares of Merger Sub.* All of the shares of Merger Sub Common Stock issued and outstanding immediately prior to the Merger Effective Time shall be automatically converted into an equal number of shares of common stock of the Surviving Corporation, with the same rights, powers and privileges as the shares so converted and shall constitute the only outstanding shares of capital stock of the Surviving Corporation.

(i) *Transfers of Ownership.* If any certificate representing securities of Acquiror is to be issued in a name other than that in which the certificate surrendered in exchange therefor is registered, it will be a condition of the issuance thereof that the certificate so surrendered will be properly endorsed (or accompanied by an appropriate instrument of transfer) and otherwise in proper form for transfer and that the person requesting such exchange will have paid to Acquiror or any agent designated by it any transfer or other Taxes required by reason of the issuance of a certificate for securities of Acquiror in any name other than that of the registered holder of the certificate surrendered, or established to the satisfaction of PubCo or any agent designated by it that such Tax has been paid or is not payable.

(j) *Surrender of Acquiror Certificates.* PubCo Securities issued upon the surrender of Acquiror Securities in accordance with the terms hereof shall be deemed to have been issued in full satisfaction of all rights pertaining to such securities,

(k) *Lost, Stolen or Destroyed Acquiror Certificates.* In the event any certificates shall have been lost, stolen or destroyed, PubCo shall issue in exchange for such lost, stolen or destroyed certificates or securities, as the case may be, upon the making of an affidavit of that fact by the holder thereof, such PubCo Securities, as may be required pursuant to this Section 2.4(d); provided, however, that PubCo may, in its discretion and as a condition precedent to the issuance thereof, require the owner of such lost, stolen or destroyed certificates to agree to indemnify PubCo and the Surviving Corporation with respect to the certificates alleged to have been lost, stolen or destroyed.

Section 2.5. Governing Documents of Surviving Corporation. At the Merger Effective Time, the certificate of incorporation and bylaws of Acquiror, each as in effect immediately prior to the Merger Effective Time, shall be amended and restated to read in their entirety in the form of the certificate of incorporation and bylaws of Merger Sub, in each case as in effect immediately prior to the Merger Effective Time, respectively (except that the name of the corporation shall be changed to “Prime Number Acquisition I Corp.”) and, as so amended and restated, shall be the certificate of incorporation and bylaws of the Surviving Corporation until the same may be thereafter further amended and/or restated in accordance with their terms and the Delaware Act.

Section 2.6. Directors and Officers of the Surviving Corporation. At the Merger Effective Time, the board of directors and executive officers of Acquiror shall resign and the board of directors and the executive officers of Merger Sub immediately prior to the Merger Effective Time shall become the board of directors and executive officers of the Surviving Corporation, each to hold office in accordance with the certificate of incorporation and bylaws of the Surviving Corporation until their respective successors are duly elected or appointed and qualified.



## ARTICLE III

### SHARE EXCHANGE

Section 3.1. Exchange of Company Ordinary Shares. No later than one (1) business day following the Merger Closing, upon the terms and subject to the conditions of this Agreement, New SubCo shall purchase, acquire and accept from the Sellers, and the Sellers shall sell, transfer, and deliver to New SubCo all of the Purchased Shares at the Aggregate Exchange Consideration at the Share Exchange Closing. All outstanding Company Convertible Securities (if any) that have not been converted or exercised prior to the Share Exchange Closing shall be terminated without any consideration, payment or liability therefor by virtue of the Share Exchange and without any further action on the part of the Company or Acquiror Entities.

Section 3.2. Exchange Consideration. Subject to and upon the terms and conditions of this Agreement, at the Share Exchange Closing, the Sellers collectively shall be entitled to receive from PubCo, in the aggregate, such number of PubCo Ordinary Shares (the "Aggregate Exchange Consideration") with an aggregate value equal to the Target Valuation, with each Seller receiving for the Company Ordinary Shares held by such Seller, such number of PubCo Ordinary Shares that is equal to the product of (a) the quotient of (i) the Target Valuation, divided by (ii) the PubCo Per Share Price, multiplied by (b) such Seller's Pro Rata Portion as set out in the Allocation Schedule. No holder of Company Equity Securities will receive any consideration under or in connection with this Agreement unless they are Sellers, either as a Signing Seller or as a Joining Seller, and then only with respect to the issued and outstanding Company Ordinary Shares that they own. Annex I to this Agreement sets forth a preliminary schedule of the allocation of the Aggregate Exchange Consideration based on Pro Rata Portion held by each Seller, provided that at least two (2) Business Days prior to the anticipated Share Exchange Closing, the Company shall deliver to Acquiror Parties an updated schedule of the allocation of the Aggregate Exchange Consideration among the Sellers, calculated in accordance with the PubCo Per Share Price and the Pro Rata Portion of each Seller (such allocation schedule as updated the "Allocation Schedule"). The Allocation Schedule is incorporated herein by reference.

Section 3.3. Share Exchange Closing.

(a) In accordance with the terms and subject to the conditions of this Agreement, the closing of the Share Exchange (the "Share Exchange Closing") shall take place as soon as practicable following the time at which the conditions set forth in Section 11.1, Section 11.3, Section 11.4 and Section 11.5 shall have been satisfied or waived (other than those conditions that by their terms are to be satisfied at the Share Exchange Closing, but subject to the satisfaction or waiver thereof) and simultaneously or immediately after the Merger Closing or such other time and place as Acquiror, PubCo and the Company may mutually agree in writing. The date on which the Share Exchange Closing actually occurs is referred to in this Agreement as the "Share Exchange Closing Date".

(b) At the Share Exchange Closing, PubCo shall issue to each Seller such number of PubCo Ordinary Shares as set forth opposite such Seller's name in the Allocation Schedule in exchange for their Company Ordinary Shares in accordance with the Allocation Schedule. No fraction of a PubCo Ordinary Share will be issued by PubCo by virtue of this Agreement or the transactions contemplated hereby, and each Person who would otherwise be entitled to a fraction of a PubCo Ordinary Share (after aggregating all fractional PubCo Ordinary Shares that would otherwise be received by such Person) shall instead have the number of PubCo Ordinary Shares issued to such Person rounded up in the aggregate to the nearest whole PubCo Ordinary Share.

(c) At the Share Exchange Closing, each Seller will deliver to New SubCo the duly executed share transfer form in respect of its Company Ordinary Shares, and the certificate(s) representing Company Ordinary Shares (the "Company Share Certificates") held by such Seller. In the event that any Company Share Certificate shall have been lost, stolen or destroyed, in lieu of delivery of a Company Share Certificate to New SubCo, such Seller may instead deliver to New SubCo a statutory declaration of lost certificate and indemnity of loss in form and substance reasonably acceptable to Acquiror and the Company.

Section 3.4. New SubCo Governance. As of the Share Exchange Closing:

(a) the amended and restated memorandum and articles of association of New SubCo in the form mutually agreed to by the Company and Acquiror (the "New SubCo Charter") shall have been duly adopted and remain in full force and effect, until thereafter amended as provided therein and under the Singapore Companies Act (the "Singapore Companies Act"), and

(b) the board of directors of New SubCo shall consist of one or more individuals whose qualification are satisfactory to the Company.

Section 3.5. Transaction Expense Statements. Subject to the occurrence of the Share Exchange Closing, at or immediately after the Share Exchange Closing, PubCo shall pay or cause to be paid by wire transfer of immediately available funds (or through payment from cash available in the Trust Account pursuant to Section 9.1), (a) all accrued and unpaid Acquiror Transaction Expenses as set forth on a written statement (the "Acquiror Transaction Expense Statement") to be delivered to the Company by or on behalf of Acquiror not less than two (2) Business Days prior to the Share Exchange Closing Date, and (b) any Company Transaction Expenses specified by the Company on a written statement (the "Company Transaction Expense Statement"), and collectively with the Acquiror Transaction Expense Statement, the "Transaction Expense Statements") to be delivered to Acquiror by or on behalf of the Company not less than two (2) Business Days prior to the Share Exchange Closing Date, which shall include, in each case of clauses (a) and (b), the respective amounts and wire transfer instructions for the payment thereof, together with corresponding invoices for the foregoing. Each of the Company and Acquiror shall provide the other party and its Representatives with reasonable access to (i) the supporting documentation used by the Company or Acquiror, as applicable, in the preparation of the applicable Transaction Expense Statement and (ii) the Company's Representatives or Acquiror's Representatives, in each case as reasonably requested by Acquiror or the Company (as applicable) in connection with Acquiror's or the Company's review of the applicable Transaction Expense Statement. Prior to the Share Exchange Closing Date, the Company and Acquiror shall consider in good faith any reasonable comments of Acquiror or the Company to the other party's Transaction Expense Statement. If the Company and Acquiror agree to make any modification to any Transaction Expense Statement, then such Transaction Expense Statement as so agreed by the Company and Acquiror to be modified shall be deemed to be the Transaction Expense Statement for purposes of determining the amounts that PubCo shall pay or cause to be paid at or immediately after the Share Exchange Closing pursuant to this Section 3.5.

## ARTICLE IV

### **REPRESENTATIONS AND WARRANTIES OF THE SELLERS**

Each Seller, severally and not jointly, represents and warrants to Acquiror Parties and the Company as of the date hereof (or with respect to a Joining Seller, as of the date such Person became a Joining Seller) and as of the Share Exchange Closing as follows:

Section 4.1. Organization and Standing. Such Seller, if not an individual natural person, is an entity duly organized, validly existing and in good standing (to the extent that the concept of “good standing” is applicable in the case of any jurisdiction outside the United States) under the Laws of the jurisdiction of its formation and has all requisite entity power and authority to own, lease and operate its properties and to carry on its business as now being conducted. Such Seller, if an individual natural person, is of legal age and sound mind.

Section 4.2. Due Authorization. Such Seller has all requisite power and authority to execute and deliver this Agreement and the other Transaction Documents to which it is a party (subject to the approvals described in Section 4.5) to consummate the transactions contemplated hereby and thereby and to perform all of its obligations hereunder and thereunder. The execution and delivery of this Agreement and the other Transaction Documents to which such Seller is a party and the consummation of the transactions contemplated hereby and thereby have been duly and validly authorized and approved by the board of directors or similar governing body of such Seller, and no other company or corporate proceeding on the part of such Seller is necessary to authorize this Agreement and the other Transaction Documents to which such Seller is a party. This Agreement has been, and on or prior to the Share Exchange Closing, the other Transaction Documents to which such Seller is a party contemplated hereby will be, duly and validly executed and delivered by such Seller and this Agreement constitutes, and on or prior to the Share Exchange Closing, the other Transaction Documents to which such Seller is a party contemplated hereby will constitute, a legal, valid and binding obligation of such Seller, enforceable against such Seller in accordance with its terms, subject to applicable bankruptcy, insolvency, fraudulent conveyance, reorganization, moratorium and similar Laws affecting creditors’ rights generally and subject, as to enforceability, to general principles of equity.

Section 4.3. Ownership. Such Seller owns good, valid and marketable title to the Purchased Shares set forth opposite such Seller's name on the Allocation Schedule, free and clear of any and all Liens (other than those imposed by applicable Laws and the Transaction Documents). There are no proxies, voting rights, shareholders' agreements or other agreements or understandings, to which such Seller is a party or by which such Seller is bound, with respect to the voting or transfer of any of such Seller's Purchased Shares other than those contemplated under the Transaction Documents. Upon delivery of such Seller's Purchased Shares to New SubCo on the Share Exchange Closing Date in accordance with this Agreement, the entire legal and beneficial interest in such Purchased Shares and good, valid and marketable title to such Purchased Shares, free and clear of all Liens (other than those imposed by applicable Laws or the Transaction Documents), will pass to New SubCo.

Section 4.4. No Conflict. Subject to the receipt of the consents, approvals, authorizations and other requirements set forth in Section 4.5, the execution and delivery by such Seller of this Agreement and the Transaction Documents to which such Seller is a party contemplated hereby and the consummation of the transactions contemplated hereby and thereby do not and will not (a) violate or conflict with any provision of, or result in the breach of, or default under the Governing Documents of such Seller (if any), or (b) violate or conflict with any provision of, or result in the breach of, or default under any Law or Governmental Order applicable to such Seller, (c) violate or conflict with any provision of, or result in the breach of, result in the loss of any right or benefit, or cause acceleration, or constitute (with or without due notice or lapse of time or both) a default (or give rise to any right of termination, cancellation or acceleration) under any Contract under which such Seller is a party, except, in the case of clauses (a) through (c), to the extent that the occurrence of the foregoing would not, individually or in the aggregate have, or reasonably be expected to have, a material adverse effect on the ability of such Seller to enter into and perform its obligations under this Agreement.

Section 4.5. Governmental Authorities; Consents. Assuming the truth and completeness of the representations and warranties of the Company and the Acquiror Parties contained in this Agreement, no Governmental Authorization is required on the part of such Seller with respect to such Seller's execution or delivery of this Agreement or the consummation by such Seller of the transactions contemplated hereby, except for any consents, approvals, authorizations, designations, declarations, waivers or filings, the absence of which would not, individually or in the aggregate have, or reasonably be expected to have, a material adverse effect on such Seller to enter into and perform its obligations under this Agreement.

Section 4.6. Litigation. There have been, and are, no claims, suits, actions or proceedings pending or, to the knowledge of such Seller, threatened against such Seller which in any manner seek to restrain, enjoin, prohibit, make illegal, or materially delay the Transactions or the performance by such Seller of its obligations under this Agreement or, when executed, any ancillary agreement to which such Seller is a party.

Section 4.7. No Additional Representations. Except as provided in this Article IV and Section 13.1, no Seller, nor any of their respective directors, commissioners, managers, officers, employees, equityholders, partners, members or Representatives has made, or is making, any representation or warranty whatsoever to Acquiror Parties or their respective Affiliates and no such party shall be liable in respect of the accuracy or completeness of any information provided to Acquiror Parties or its Affiliates or their respective Representatives

## ARTICLE V

### REPRESENTATIONS AND WARRANTIES OF THE COMPANY

Except (a) as set forth in the disclosure letter delivered to Acquiror by the Company on the date of this Agreement (as may be updated pursuant to Section 8.6, the “Company Disclosure Letter”) (each section of the Company Disclosure Letter, subject to Section 13.9, qualifies the correspondingly numbered and lettered representations and warranties in this Article V) and (b) as otherwise explicitly contemplated by this Agreement, the Company represents and warrants to Acquiror as of the date hereof and as of the Share Exchange Closing as follows.

Section 5.1. Company Organization. The Company has been duly formed or organized and is validly existing under the Laws of its jurisdiction of incorporation or organization, and has the requisite company or corporate power, as applicable, and authority to own, lease or operate all of its properties and assets and to conduct its business as it is now being conducted. The Governing Documents of the Company, as amended to the date of this Agreement and as previously made available by or on behalf of the Company to Acquiror, are true, correct and complete. The Company is duly licensed or qualified and in good standing as a foreign or extra-provincial corporation (or other entity, if applicable) in each jurisdiction in which its ownership of property or the character of its activities is such as to require it to be so licensed or qualified or in good standing, as applicable, except where the failure to be so licensed or qualified or in good standing would not be material to the business of the Company and its Subsidiaries, taken as a whole.

Section 5.2. Subsidiaries. A complete list of each Subsidiary of the Company and its jurisdiction of incorporation, formation or organization, outstanding Equity Securities, and holders of Equity Securities (including respective numbers and percentages), as applicable, is set forth on Section 5.2 of the Company Disclosure Letter. The Subsidiaries of the Company have been duly formed or organized and are validly existing under the Laws of their jurisdiction of incorporation or organization and have the requisite power and authority to own, lease or operate all of their respective properties and assets and to conduct their respective businesses as they are now being conducted. True, correct and complete copies of the Governing Documents of the Company’s Subsidiaries, in each case, as amended to the date of this Agreement, have been previously made available to Acquiror by or on behalf of the Company. Each Subsidiary of the Company is duly licensed or qualified and in good standing as a foreign corporation (or other entity, if applicable) in each jurisdiction in which its ownership of property or the character of its activities is such as to require it to be so licensed or qualified or in good standing, as applicable, except where the failure to be so licensed or qualified or in good standing would not be material to the business of the Company.

Section 5.3. Due Authorization.

(a) The Company has all requisite company or corporate power, as applicable, and authority to execute and deliver this Agreement and the other documents to which it is a party contemplated hereby and (subject to the approvals described in Section 5.5) to consummate the transactions contemplated hereby and thereby and to perform all of its obligations hereunder and thereunder. The execution and delivery of this Agreement and the other Transaction Documents to which the Company is a party contemplated hereby and the consummation of the transactions contemplated hereby and thereby have been duly and validly authorized and approved by the board of directors of the Company, and no other company or corporate proceeding on the part of the Company is necessary to authorize this Agreement and the other Transaction Documents to which the Company is a party contemplated hereby. This Agreement has been, and on or prior to the Share Exchange Closing, the other Transaction Documents to which the Company is a party contemplated hereby will be, duly and validly executed and delivered by the Company and this Agreement constitutes, and on or prior to the Share Exchange Closing, the other Transaction Documents to which the Company is a party contemplated hereby will constitute, a legal, valid and binding obligation of the Company, enforceable against the Company in accordance with its terms, subject to applicable bankruptcy, insolvency, fraudulent conveyance, reorganization, moratorium and similar Laws affecting creditors' rights generally and subject, as to enforceability, to general principles of equity.

(b) On or prior to the date of this Agreement, the board of directors of the Company has duly adopted resolutions (i) determining that this Agreement and the other Transaction Documents to which the Company is a party contemplated hereby and the transactions contemplated hereby and thereby are advisable and fair to, and in the best interests of, the Company and its stockholders, as applicable, and (ii) authorizing and approving the execution, delivery and performance by the Company of this Agreement and the other Transaction Documents to which the Company is a party contemplated hereby and the transactions contemplated hereby and thereby. No other corporate action is required on the part of the Company or any of its shareholders to enter into this Agreement or the documents to which the Company is a party contemplated hereby or to approve the Transactions, other than the Company Shareholder Approval.

Section 5.4. No Conflict. Subject to the receipt of the consents, approvals, authorizations and other requirements set forth in Section 5.5, the execution and delivery by the Company of this Agreement and the other Transaction Documents to which the Company is a party contemplated hereby and the consummation of the transactions contemplated hereby and thereby do not and will not (a) violate or conflict with any provision of, or result in the breach of, or default under the Governing Documents of any Group Company, (b) violate or conflict with any provision of, or result in the breach of, or default under any Law or Governmental Order applicable to any Group Company, (c) violate or conflict with any provision of, or result in the breach of, result in the loss of any right or benefit, or cause acceleration, or constitute (with or without due notice or lapse of time or both) a default (or give rise to any right of termination, cancellation, modification or acceleration) under any Material Contract to which any Group Company is a party or by which the Company or any of the Company's Subsidiaries may be bound, or terminate or result in the termination of any such foregoing Contract or (d) result in the creation of any Lien (other than Permitted Liens) upon any of the properties or assets of any Group Company, except, in the case of clauses (b) through (d), to the extent that the occurrence of the foregoing would not, individually or in the aggregate, (i) have, or reasonably be expected to have, a material adverse effect on the ability of any Group Company to enter into and perform their obligations under this Agreement, or (ii) be or reasonably be expected to be material to the business of the Group Companies (taken as a whole).

Section 5.5. Governmental Authorities; Consents. Assuming the truth and completeness of the representations and warranties of the Sellers and the Acquiror Parties contained in this Agreement, no Governmental Authorization is required on the part of any Group Company with respect to the Company's execution or delivery of this Agreement or the consummation by the Company of the transactions contemplated hereby, except for any consents, approvals, authorizations, designations, declarations, waivers or filings, the absence of which would not, individually or in the aggregate, (i) have, or reasonably be expected to have, a material adverse effect on the ability of the Company to enter into and perform its obligations under this Agreement, or (ii) be or reasonably be expected to be material to the business of the Group Companies (taken as a whole).

Section 5.6. Capitalization of the Company.

(a) As of the date of this Agreement, the issued and outstanding share capital of the Company consists of 325,332 Company Ordinary Shares. Set forth in Section 5.6 of the Company Disclosure Letter is a true, correct and complete list of each legal owner of Company Ordinary Shares or other Equity Securities of the Company and the number of Company Ordinary Shares or other Equity Securities held by each such holder as of the date hereof. Except as set forth in Section 5.6 of the Company Disclosure Letter or pursuant to the Permitted Activities Documents, as of the date hereof there are no other ordinary shares, preferred shares or other Equity Securities of the Company authorized, reserved for issuance, issued or outstanding. All of the issued and outstanding Company Shares (x) have been duly authorized and validly issued and allotted and are fully paid; (y) have been offered, sold, transferred and issued in compliance with applicable Law; and (z) are free and clear of any Liens.

(b) The Company has not issued, granted, and is not otherwise bound by or subject to any outstanding subscriptions, options, warrants, rights or other securities (including debt securities) convertible, exercisable or exchangeable for Company Ordinary Shares, any other commitments, calls, conversion rights, rights of exchange or privilege (whether pre-emptive, contractual or by matter of Law), plans or other agreements of any character providing for the issuance of additional shares, the sale of treasury shares or other equity interests, or for the repurchase or redemption of shares or other equity interests of the Company or the value of which is determined by reference to shares or other equity interests of the Company, and there are no voting trusts, proxies or agreements of any kind which may obligate the Company to issue, purchase, register for sale, redeem or otherwise acquire any Company Ordinary Shares.

Section 5.7. Capitalization of Subsidiaries.

(a) The outstanding share capital or other Equity Securities of each of the Company's Subsidiaries (i) have been duly authorized and validly issued and allotted, are, to the extent applicable, fully paid and non-assessable; (ii) have been offered, sold, issued and allotted in compliance with applicable Law, including federal and state securities Laws, and all requirements set forth in (1) the Governing Documents of each such Subsidiary, and (2) any other applicable Contracts governing the issuance or allotment of such securities; and (iii) are not subject to, nor have they been issued in violation of, any purchase option, call option, right of first refusal, preemptive right, subscription right or any similar right under any provision of any applicable Law, the Governing Documents of each such Subsidiary or any Contract to which each such Subsidiary is a party or otherwise bound.

(b) Except as set forth in Section 5.2 and Section 5.7 of the Company Disclosure Letter, the Company owns of record and beneficially all the issued and outstanding Equity Securities of such Subsidiaries free and clear of any Liens.

(c) There are no outstanding subscriptions, options, warrants, rights or other securities (including debt securities) exercisable or exchangeable for any Equity Securities of such Subsidiaries, any other commitments, calls, conversion rights, rights of exchange or privilege (whether pre-emptive, contractual or by matter of Law), plans or other agreements of any character providing for the issuance of additional shares, the sale of treasury shares or other equity interests, or for the repurchase or redemption of shares or other Equity Securities of such Subsidiaries or the value of which is determined by reference to shares or other equity interests of the Subsidiaries, and there are no voting trusts, proxies or agreements of any kind which may obligate any Subsidiary of the Company to issue, purchase, register for sale, redeem or otherwise acquire any of its Equity Securities.

Section 5.8. Statutory Registers. All registers, statutory books, books of account and other corporate records of any Group Company are maintained in accordance with applicable Law on a proper and consistent basis, contain complete and accurate records of all material matters required to be dealt with in such books and records, and have as required by Law attached to them copies of all such resolutions and agreements when filed.



Section 5.9. Financial Statements; Internal Controls.

(a) Attached as Section 5.9(a) of the Company Disclosure Letter are: true, fair and complete copies of the unaudited consolidated balance sheets of the Group Companies, and the related statements of operations and statements of cash flows, as of and for the years ended June 30, 2022 and June 30, 2021 (the "Interim Statements Date(s)") (such financial statements, the "Interim Financial Statements").

(b) The Interim Financial Statements (i) were prepared from the books and records of the Group Companies; (ii) were prepared on an accrual basis in accordance with GAAP; (iii) contain and reflect all necessary adjustments and accruals for a fair presentation of the Company's financial condition on a consolidated basis as of applicable Interim Statements Date including for all warranty, maintenance, services and indemnification obligations; and (iv) contain and reflect adequate provisions for all Liabilities for all material Taxes applicable to the Company with respect to the applicable Interim Statements Date. The Interim Financial Statements truly and fairly reflect in all material respects the outstanding Indebtedness of the Company as of the applicable Interim Statement Date, subject to any adjustment in the Audited Financial Statements. The Audited Financial Statements when delivered (i) shall give a true and fair view of the consolidated financial position of the Company and its consolidated Subsidiaries, as at the respective dates thereof, and the consolidated results of their operations, their consolidated incomes, their consolidated changes in equity and their consolidated cash flows for the respective periods then ended, (ii) shall have been prepared in conformity with GAAP applied on a consistent basis during the periods involved (except as may be indicated in the notes thereto), (iii) shall have been prepared from, and shall have been in accordance in all material respects with, the books and records of the Company and its consolidated Subsidiaries, (iv) shall contain and reflect all necessary adjustments and accruals for a fair presentation of the Company's financial position on a consolidated basis as of their dates including for all warranty, maintenance, service and indemnification obligations, (v) shall contain and reflect adequate provisions for all Liabilities for all material Taxes applicable to the Group Companies with respect to the periods then ended, and (vi) in the case of the PCAOB Financial Statements when delivered by the Company for inclusion in the Proxy/Registration Statement for filing with the SEC following the date of this Agreement in accordance with Section 8.3, will comply in all material respects with the applicable accounting requirements (including the standards of the PCAOB) and with the rules and regulations of the SEC, the Exchange Act and the Securities Act applicable to a registrant, in effect as of the respective dates thereof.

(c) Neither the Company nor any director or officer of the Company nor or any of its Subsidiaries, to the knowledge of the Company, any independent auditor of the Company or its Subsidiaries, has, since July 1, 2020, identified or been made aware of (i) any significant deficiency or material weakness in the system of internal accounting controls utilized by the Company or any of its Subsidiaries, (ii) any fraud, whether or not material, that involves the Company's management or other employees who have a role in the preparation of financial statements or the internal accounting controls utilized by the Company or any of its Subsidiaries or (iii) any claim or allegation regarding any of the foregoing.

(d) Since July 1, 2020, the Company has maintained a system of internal accounting controls which is reasonably sufficient to provide reasonable assurance that (i) transactions are executed in accordance with management's general or specific authorizations, (ii) transactions are recorded as necessary to permit preparation of financial statements in conformity with GAAP and to maintain asset accountability, (iii) access to assets is permitted only in accordance with management's general or specific authorization and (iv) the recorded accountability for assets is compared with the existing assets at reasonable intervals and appropriate action is taken with respect to any differences. The books and records of the Company have been, and are being, maintained in all material respects in accordance with FRSs and any other applicable legal and accounting requirements.

(e) The Company Board would, as of the date hereof and as of the Share Exchange Closing Date be able to give a solvency statement in relation to the Company in accordance with Section 215I and Section 215J of the Singapore Companies Act, to effect the Share Exchange, and the Company is not aware of any fact, matter or circumstance that has occurred or is reasonably expected to occur which would render the Company Board unable to give such solvency statement when required to do so in connection with the Share Exchange.

Section 5.10. Undisclosed Liabilities. Except as set forth on the Interim Financial Statements, there has been no liability, debt (including Indebtedness) or obligation of, or claim or judgment against, any Group Company (whether direct or indirect, absolute or contingent, accrued or unaccrued, known or unknown, liquidated or unliquidated, or due or to become due), except for liabilities, debts, obligations, claims or judgments (a) reflected or reserved for on the Audited Financial Statements or disclosed in the notes thereto, (b) that have arisen since the date of the most recent statement of financial position included in the Audited Financial Statements in the ordinary course of business, consistent with past practice, of any Group Company or (c) that will be discharged or paid off prior to or at the Share Exchange Closing since June 30, 2022.

Section 5.11. Litigation and Proceedings. Except as set forth on Section 5.11 of the Company Disclosure Letter, (a) there are no pending or, to the knowledge of the Company, threatened, lawsuits, actions, suits, judgments, claims, proceedings or any other Actions (including any investigations or inquiries initiated, pending or threatened by any Governmental Authority), or other proceedings at law or in equity (collectively, "Legal Proceedings"), against the Company or any of the Company's Subsidiaries or their respective properties or assets; and (b) since January 1, 2021, neither the Company nor any Company Subsidiary has had any Governmental Order imposed on it; (ii) none of the properties or assets of the Company or any of the Company's Subsidiaries' respective businesses is, or has been since January 1, 2021, bound or subject to any Governmental Order, except, in each case of (i) and (ii), as would not, individually or in the aggregate, be or reasonably be expected to be material to the business of the Company and its Subsidiaries (taken as a whole).

Section 5.12. Legal Compliance.

(a) Except as would not be or reasonably be expected to be material to the business of the Company and its Subsidiaries (taken as a whole), each of the Company and its Subsidiaries is currently, or has been since July 25, 2019, in compliance with all applicable Laws in all material respects.

(b) Since July 25, 2019, none of the Company or any of its Subsidiaries has received any written notice of, or been charged with, the violation of any Laws, except where such violation has not been and would not reasonably be expected to be material to the business of the Company and its Subsidiaries, taken as a whole.

(c) The Company and its Subsidiaries maintain a program of policies, procedures and internal controls reasonably designed and implemented to provide reasonable assurance that violation of applicable Law by any of the Company's or its Subsidiaries' directors, officers, employees or its or their respective Representatives or other Persons, acting on behalf of the Company or any of the Company's Subsidiaries, will be prevented, detected and deterred.

Section 5.13. Contracts; No Defaults.

(a) True, correct and complete copies of the Contracts (A) described in clauses (i) through (xv) below and (B) to which the Company or any of the Company's Subsidiaries is a party or by which they are bound have been delivered to or made available to Acquiror or its Representatives, together with all amendments thereto (collectively, the "Material Contracts"). Section 5.13(a) of the Company Disclosure Letter sets forth the list of such Material Contracts.

(i) Each Contract involving obligations (contingent or otherwise), payments or revenues in excess of \$200,000 in the last twelve (12) months prior to the date of this Agreement or expected obligations (contingent or otherwise), payments or revenues in excess of \$200,000 in the next twelve (12) months after the date of this Agreement;

(ii) Each note, debenture, other evidence of Indebtedness, guarantee, loan, credit or financing agreement or instrument or other Contract for money borrowed by, or other Indebtedness of, the Company or any of the Company's Subsidiaries, including any other agreement or commitment for future loans, credit or financing, in each case, in excess of \$200,000;

(iii) Each Contract for the acquisition of any Person or any business unit thereof or the disposition of any material assets of the Company or any of its Subsidiaries in the last two (2) years, in each case, involving payments in excess of \$200,000 other than Contracts (A) in which the applicable acquisition or disposition has been consummated and there are no material obligations ongoing, or (B) solely between the Company and its Subsidiaries;

(iv) Each lease, rental or occupancy agreement, license, installment and conditional sale agreement, and other Contract that provides for the ownership of, leasing of, title to, use of, or any leasehold or other interest in any real or personal property that involves aggregate payments in excess of \$100,000 in any calendar year;

(v) Each Contract involving the formation, establishment, contribution to, or operation of a (A) partnership, (B) corporation, limited liability company or other entity, or (C) joint venture, alliance or similar entity, or involving a sharing of profits or losses (including joint development and joint marketing Contracts), or any investment in, loan to or acquisition or sale of the securities, Equity Securities or assets of any person involving payments of an amount higher than \$500,000 (excluding, in the case of clauses (A) and (B), any Subsidiary of the Company);

(vi) Contracts between the Company or any of its Subsidiaries, on the one hand, and any Company Related Party, on the other hand (collectively, "Related Party Agreements"), since July 25, 2019, other than (i) Contracts with respect to a Company Related Party's employment or other similar engagement and confidentiality agreements, and (ii) end-user, consumer, client or customer agreements entered into on an arm's length basis, or (iii) other agreements of a similar nature, in each case with the Company or any of its Subsidiaries entered into in the ordinary course of business consistent with past practice;

(vii) Contracts with each current or former executive officer, director or executive level employee of any Group Company since January 1, 2021;

(viii) Contracts that provide for change in control, retention or similar payments or benefits contingent upon, accelerated by or triggered by the consummation of the transactions contemplated hereby;

(ix) Contracts containing covenants of the Company or any of the Company's Subsidiaries (A) prohibiting or limiting the right of the Company or any of the Company's Subsidiaries to engage in or compete with any Person in any line of business in any material respect or (B) prohibiting or restricting the Company's and the Company's Subsidiaries' ability to conduct their business in any geographic area in any material respect;

(x) Each Contract (including license agreements, coexistence agreements, and agreements with covenants not to sue, but not including non-disclosure agreements, contractor services agreements, consulting services agreements, incidental trademark licenses incident to marketing, printing or advertising Contracts) pursuant to which the Company or any of the Company's Subsidiaries (A) grants to a third Person the exclusive right to use Intellectual Property of the Company and its Subsidiaries that is material to the business of the Company and its Subsidiaries, taken as a whole, or (B) is granted by a third Person the right to use Intellectual Property that is material to the business of the Company and its Subsidiaries taken as a whole (other than Contracts granting nonexclusive rights to use commercially available off-the-shelf software and Open Source Licenses) (collectively, the Contracts within the scope of this clause (B), the "Material In-Licenses");

(xi) Each Contract requiring capital expenditures by the Company or any of the Company's Subsidiaries after the date of this Agreement in an amount in excess of \$200,000 in any calendar year;

(xii) Any Contract that grants to any third Person any "most favored nation rights";

(xiii) Contracts granting to any Person (other than the Company or its Subsidiaries) a right of first refusal, first offer or similar preferential right to purchase or acquire equity interests in the Company or any of the Company's Subsidiaries;

(xiv) Contracts in connection with the waiver, compromise, or settlement of any dispute, claim, litigation or arbitration involving an Action, claim or proceeding in an amount higher than \$200,000; and

(xv) Contracts with a Governmental Authority or sole-source supplier of any product or service (other than utilities), in each case involving payments of an amount higher than \$200,000.

(b) Except for any Contract that will terminate upon the expiration of the stated term thereof prior to the Share Exchange Closing Date, all of the Material Contracts are (i) in full force and effect and (ii) represent the legal, valid and binding obligations of the Company or the relevant Subsidiary of the Company thereto and, to the knowledge of the Company, represent the legal, valid and binding obligations of the counterparties thereto. Except, in each case, where the occurrence of such breach or default or failure to perform would not be material to the business of the Company and its Subsidiaries, taken as a whole, (x) the Company and its Subsidiaries have performed in all respects all respective obligations required to be performed by them to date under such Material Contracts and neither the Company, the Company's Subsidiaries, nor, to the knowledge of the Company, any other party thereto is in breach of or default under any such Contract, (y) during the last twelve (12) months, neither the Company nor any of its Subsidiaries has received any written claim or written notice of termination or breach of or default under any such Material Contract, and (z) to the knowledge of the Company, no event has occurred which individually or together with other events, has or would reasonably be expected to result in a breach of or a default under any such Material Contract by the Company or any of its Subsidiaries or, to the knowledge of the Company, any other party thereto (in each case, with or without notice or lapse of time or both).

Section 5.14. Company Benefit Plans.

(a) Section 5.14(a) of the Company Disclosure Letter sets forth a complete list, as of the date hereof, of each material Company Benefit Plan. With respect to each material Company Benefit Plan, the Company has made available to Acquiror or its Representatives, to the extent applicable, true, complete and correct copies of such Company Benefit Plan (or, if not in writing, a written summary of its material terms) and, as applicable, all plan documents, trust agreements, insurance Contracts or other funding vehicles and all amendments or material modifications thereto.

(b) Except as set forth on Section 5.14(b) of the Company Disclosure Letter, each Company Benefit Plan has been established, operated, funded, maintained and administered in compliance with its terms and all applicable Laws, except where failure to comply would not be or reasonably be expected to be material to the Company and its Subsidiaries, taken as a whole.

Section 5.15. Labor Relations; Employees.

(a) Except as set forth on Section 5.15(a) of the Company Disclosure Letter, (i) neither the Company nor any of its Subsidiaries is a party to or bound by any collective bargaining agreement or any similar agreement, (ii) no such agreement is being negotiated by the Company or any of the Company's Subsidiaries, and (iii) no labor union or any other employee representative body has requested or, to the knowledge of the Company, has sought to represent any of the employees of the Company or its Subsidiaries in the past three (3) years. In the past three (3) years, to the knowledge of the Company, there has been no labor organization activity involving any employees of the Company or any of its Subsidiaries and there has been no actual or, to the knowledge of the Company, threatened strike, slowdown, work stoppage, lockout or other labor dispute against or affecting the Company or any Subsidiary of the Company, in each case except as would not be or reasonably be expected to be, individually or in the aggregate, material to the business of the Company and its Subsidiaries, taken as a whole.

(b) Each of the Company and its Subsidiaries are, and have been for the past three (3) years, in compliance with all applicable Laws respecting labor and employment including, but not limited to, all Laws respecting terms and conditions of employment, health and safety, wages and hours, holiday pay and the calculation of holiday pay, working time, employee classification (with respect to both exempt vs. non-exempt status and employee vs. independent contractor and worker status), child labor, immigration, employment discrimination, disability rights or benefits, equal opportunity and equal pay, plant closures and layoffs, affirmative action, workers' compensation, labor relations, employee leave issues, unemployment insurance and contributions required to be made with respect to any statutory plan, program, practice or arrangement that is required under applicable law and maintained by any Governmental Authority, except where the failure to comply would not be or reasonably be expected to be, individually or in the aggregate, material to the business of the Company and its Subsidiaries, taken as a whole.

(c) Except where it would not be or reasonably be expected to be, individually or in the aggregate, material to the business of the Company and its Subsidiaries, in the past three (3) years, the Company and its Subsidiaries have not received written (i) notice of any unfair labor practice charge or material complaint pending or threatened before any applicable Governmental Authority against them, (ii) notice of any complaints, grievances or arbitrations arising out of any collective bargaining agreement or any other material complaints, grievances or arbitration procedures against them, (iii) notice of any material charge or complaint with respect to or relating to them pending before any applicable Governmental Authority responsible for the prevention of unlawful employment practices, (iv) notice of the intent of any Governmental Authority responsible for the enforcement of labor, employment, wages and hours of work, child labor, immigration, or occupational safety and health Laws to conduct an investigation with respect to or relating to them or notice that such investigation is in progress, or (v) notice of any complaint, lawsuit or other proceeding pending or threatened in any forum by or on behalf of any present or former employee of such entities, any applicant for employment or classes of the foregoing alleging breach of any express or implied Contract of employment, any applicable Law governing employment or the termination thereof or other discriminatory, wrongful or tortious conduct in connection with the employment relationship.

(d) To the knowledge of the Company, no present or former employee, worker or independent contractor of the Company or any of the Company's Subsidiaries' is in material violation of (i) any restrictive covenant, nondisclosure obligation or fiduciary duty to the Company or any of the Company's Subsidiaries or (ii) any restrictive covenant or nondisclosure obligation to a former employer or engager of any such individual relating to (A) the right of any such individual to work for or provide services to the Company or any of the Company's Subsidiaries' or (B) the knowledge or use of trade secrets or proprietary information, in each case except as would not be or reasonably be expected to be, individually or in the aggregate, material to the business of the Company and its Subsidiaries, taken as a whole.

(e) Neither the Company nor any of the Company's Subsidiaries is party to a settlement agreement with a current or former officer, employee or independent contractor of the Company or any of the Company's Subsidiaries that involves allegations relating to sexual harassment, sexual misconduct or discrimination by either (i) an officer of the Company or any of the Company's Subsidiaries or (ii) an employee of the Company or any of the Company's Subsidiaries at the level of Director (for the avoidance of doubt, such title does not refer to a member of the board of directors) or above. To the knowledge of the Company, in the last three (3) years, no allegations of sexual harassment, sexual misconduct or discrimination have been made against (i) an officer of the Company or any of the Company's Subsidiaries or (ii) an employee of the Company or any of the Company's Subsidiaries at the level of Director (for the avoidance of doubt, such title does not refer to a member of the board of directors) or above, in each case except as would not be or reasonably be expected to be, individually or in the aggregate, material to the Company and its Subsidiaries, taken as a whole.

Section 5.16. Taxes.

(a) All material Tax Returns required to be filed by or with respect to the Company or any of its Subsidiaries have been timely filed (taking into account any applicable extensions), all such Tax Returns (taking into account all amendments thereto) are true, correct and complete in all material respects, and all material Taxes due and payable (whether or not shown on any Tax Return) have been paid.

(b) The Company and each of its Subsidiaries have withheld from amounts owing to any employee, creditor or other Person all material Taxes required by applicable Law to be withheld, paid over to the proper Governmental Authority in a timely manner all such withheld amounts required to have been so paid over and complied in all material respects with all applicable withholding and related reporting requirements with respect to such Taxes.

(c) There are no Liens for Taxes (other than Permitted Liens) upon the property or assets of the Company or any of its Subsidiaries.

(d) No claim, assessment, deficiency or proposed adjustment for any material amount of Tax has been asserted in writing or assessed by any Governmental Authority against the Company or any of its Subsidiaries that remains unresolved or unpaid.

(e) There is no material Tax audit or other examination of the Company or any of its Subsidiaries presently in progress with respect to any material Taxes, nor has the Company or any of its Subsidiaries been notified in writing of any request or threat for such an audit or other examination, and there are no waivers, extensions or written requests for any waivers or extensions of any statute of limitations currently in effect with respect to any material Taxes of the Company or any of its Subsidiaries.

(f) Neither the Company nor any of its Subsidiaries has made a request for or entered into a closing agreement, private letter ruling, advance tax ruling or similar agreement with any Governmental Authority with respect to Taxes. Neither the Company nor any of its Subsidiaries has made a change of any method of accounting with respect to any Taxes.

(g) Neither the Company nor any of its Subsidiaries is a party to any Tax indemnification or Tax sharing or similar Tax agreement (other than any such agreement solely between the Company and its existing Subsidiaries and customary commercial Contracts (or Contracts entered into in the ordinary course of business) not primarily related to Taxes).

(h) Neither the Company nor any of its Subsidiaries (i) is liable for Taxes of any other Person (other than the Company and its Subsidiaries) under Treasury Regulation Section 1.1502-6 or any similar provision of state, local or foreign Tax Law or as a transferee or successor or by Contract (other than customary commercial Contracts (or Contracts entered into in the ordinary course of business) not primarily related to Taxes) or (ii) has ever been a member of an affiliated, consolidated, combined or unitary group filing for U.S. federal, state or local income Tax purposes, other than a group the common parent of which was or is the Company or any of its Subsidiaries.



(i) Within the past three (3) years, no written claim has been made by any Governmental Authority where the Company or any of its Subsidiaries does not file Tax Returns that it is or may be subject to taxation in that jurisdiction.

(j) Neither the Company nor any of its Subsidiaries has participated in a “listed transaction” within the meaning of Treasury Regulation 1.6011-4(b)(2).

(k) The Company has not been, is not, and immediately prior to the Share Exchange Closing will not be, treated as an “investment company” within the meaning of Section 368(a)(2)(F) of the Code.

(l) Except as contemplated by this Agreement and the Transactions contemplated hereby, neither the Company nor any of its Subsidiaries has taken any action or agreed to take any action, nor to the knowledge of the Company or any of its Subsidiaries are there any facts or circumstances, that could reasonably be expected to prevent the Transactions from qualifying for the Intended Tax Treatment.

Section 5.17. Insurance. Section 5.17 of the Company Disclosure Letter contains a list of, as of the date hereof, all material policies or binders of property, fire and casualty, product liability, workers’ compensation, and other forms of insurance held by, or for the benefit of, the Company as of the date of this Agreement. True, correct and complete copies of such insurance policies as in effect as of the date hereof have previously been made available to Acquiror or its Representatives. All such policies are in full force and effect, all premiums due have been paid, and no written notice of cancellation or termination has been received by the Company or any of the Company’s Subsidiaries with respect to any such policy. Except as disclosed on Section 5.17 of the Company Disclosure Letter, no insurer has denied or disputed coverage of any material claim under an insurance policy during the last two (2) years.

Section 5.18. Licenses. The Company and its Subsidiaries have obtained, and maintain, all of the material Licenses required to permit the Company and its Subsidiaries to acquire, originate, own, operate, use and maintain their assets substantially in the manner in which they are now operated and maintained and to conduct the business of the Company and its Subsidiaries as currently conducted in all material respects. Each material License held by the Company or any of the Company’s Subsidiaries is in full force and effect. Neither the Company nor any of its Subsidiaries (a) is in default or violation (and no event has occurred which, with notice or the lapse of time or both, would constitute a material default or violation) of any term, condition or provision of any material License to which it is a party, (b) is or has been the subject of any pending or threatened Action by a Governmental Authority seeking the revocation, suspension, termination, modification, or impairment of any material License; or (c) has received any notice that any Governmental Authority that has issued any material License intends to cancel, terminate, or not renew any such material License, except to the extent such material License may be amended, replaced, or reissued as a result of and as necessary to reflect the transactions contemplated hereby, or as otherwise disclosed in Section 5.18 of the Company Disclosure Letter. Section 5.18 of the Company Disclosure Letter sets forth a true, correct and complete list of all material Licenses held by the Company or its Subsidiaries.

Section 5.19. Equipment and Other Tangible Property. The Company or one of its Subsidiaries owns and has good title to, and has the legal and beneficial ownership of or a valid leasehold interest in or right to use by license or otherwise, all material machinery, equipment and other material tangible property reflected on the books of the Company and its Subsidiaries as owned by the Company or one of its Subsidiaries, free and clear of all Liens other than Permitted Liens. All material personal property and leased personal property assets of the Company and its Subsidiaries are, to the knowledge of the Company, structurally sound and in good operating condition and repair (ordinary wear and tear expected) and are suitable for their present use.

Section 5.20. Real Property. Section 5.20 of the Company Disclosure Letter sets forth a true, correct and complete list, as of the date of this Agreement, of (w) the street address of each parcel of Leased Real Property, (x) the identity of the lessor, lessee and current occupant (if different from lessee) of each such parcel of Leased Real Property, and (y) the term and rental payment amounts pertaining to each such parcel of Leased Real Property. Neither the Company nor its Subsidiaries owns any real property. Except as would not be or reasonably be expected to be material to the business of the Company and its Subsidiaries, taken as a whole, with respect to each parcel of Leased Real Property:

(a) The Company or one of its Subsidiaries holds a good and valid leasehold estate in such Leased Real Property, free and clear of all Liens, except for Permitted Liens.

(b) The Company and its Subsidiaries have delivered to Acquiror true, correct and complete copies of all leases, lease guaranties, subleases, agreements for the leasing, use or occupancy of, or otherwise granting a right in and to the Leased Real Property by or to the Company or any of its Subsidiaries, including all amendments, terminations and modifications thereof (collectively, the "Real Property Leases"), and none of such Real Property Leases has been modified in any material respect, except to the extent that such modifications have been disclosed by the copies delivered to Acquiror.

(c) The Company's and its Subsidiaries', as applicable, possession and quiet enjoyment of the Leased Real Property under such Real Property Leases has not been materially disturbed and, to the knowledge of the Company, there are no material disputes with respect to such Real Property Leases.

(d) To the knowledge of the Company, no party, other than the Company or its Subsidiaries, has any right to use or occupy the Leased Real Property or any portion thereof.

(e) Neither the Company nor any of its Subsidiaries has received written notice of any condemnation proceeding or proposed similar Action or agreement for taking in lieu of condemnation with respect to any portion of the Leased Real Property. No material defaults by (A) the Company or its Subsidiaries or (B) to the knowledge of the Company, any landlord or sub-landlord, as applicable, presently exists under any Real Property Lease.

Section 5.21. Intellectual Property.

(a) Section 5.21(a) of the Company Disclosure Letter lists each item of material Intellectual Property that is registered or applied-for with a Governmental Authority and is owned by the Company or any of the Company's Subsidiaries as of the date of this Agreement ("Company Registered Intellectual Property"), and material proprietary software owned by the Company or one of the Company's Subsidiaries. The Company or one of the Company's Subsidiaries is the sole and exclusive beneficial and record owner of all of the items of Company Registered Intellectual Property, and, to the knowledge of the Company, all such Company Registered Intellectual Property is subsisting and is valid and enforceable.

(b) Except as would not be expected to be material to the Company and its Subsidiaries, taken as a whole, the Company or one of its Subsidiaries owns, free and clear of all Liens (other than Permitted Liens), or has a valid right to use, all Intellectual Property reasonably necessary or material for the continued conduct of the business of the Company and its Subsidiaries in substantially the same manner as such business has been operated during the twelve (12) months prior to the date hereof.

(c) In respect of any Material In-Licenses granting the Company or any of its Subsidiaries the right to use any Intellectual Property reasonably necessary for the continued conduct of the business of the Company and its Subsidiaries in substantially the same manner as such business has been operated during the twelve (12) months prior to the date hereof (including all amendments, novations, supplements or replacements to such Material In-Licenses), to the knowledge of the Company: (i) such Material In-Licenses are in full force and effect, with no termination notice having been received by the Company or any of its Subsidiaries thereunder; (ii) to the knowledge of the Company, no circumstances exist or have existed which entitle the licensor party to terminate or vary such Material In-Licenses; and (iii) the material obligations of the Company and its Subsidiaries under such Material In-Licenses have been complied with; in each case except as would not be or reasonably be expected to be, individually or in the aggregate, material to the business of the Company and its Subsidiaries, taken as a whole.

(d) The Company and its Subsidiaries have not, within the last three (3) years, infringed upon, misappropriated or otherwise violated and, as of the date of this Agreement, are not infringing upon, misappropriating or otherwise violating any Intellectual Property of any third Person, and there is no action pending to which the Company or any of the Company's Subsidiaries is a named party, or as to which the Company or any of its Subsidiaries has received a threat in writing, alleging the Company's or its Subsidiaries' infringement, misappropriation or other violation of any Intellectual Property of any third Person, in each case except as would not be or reasonably be expected to be, individually or in the aggregate, material to the business of the Company and its Subsidiaries, taken as a whole.

(e) Except as set forth on Section 5.21(e) of the Company Disclosure Letter, to the knowledge of the Company (i) no Person is infringing upon, misappropriating or otherwise violating any material Intellectual Property of the Company or any of the Company's Subsidiaries in any material respect, and (ii) the Company and its Subsidiaries have not sent to any Person within the last three (3) years any written notice, charge, complaint, claim or other written assertion against such third Person claiming infringement or violation by or misappropriation of any Intellectual Property of the Company or any of the Company's Subsidiaries.

(f) The Company and its Subsidiaries have taken commercially reasonable measures to protect the confidentiality of trade secrets and other confidential information included in their Intellectual Property that are material to the business of the Company and its Subsidiaries, taken as a whole. To the knowledge of the Company, there has not been any unauthorized disclosure of or unauthorized access to any material trade secrets or other material confidential information of the Company or any of the Company's Subsidiaries to or by any Person in a manner that has resulted or may result in the misappropriation of, or loss of trade secret or other rights in and to such information.

(g) No government funding, nor any facilities of a university, college, other educational institution or research center, was used in the development of the material Intellectual Property owned by the Company or any of the Company's Subsidiaries and used in connection with the business.

(h) With respect to the software used or held for use in the business of the Company and its Subsidiaries, to the knowledge of the Company, no such software contains any undisclosed or hidden device or feature designed to disrupt, disable, or otherwise impair the functioning of any software or any "back door," "time bomb," "Trojan horse," "worm," "drop dead device," or other malicious code or routines that permit unauthorized access or the unauthorized disablement or erasure of such or other software or information or data (or any parts thereof) of the Company or its Subsidiaries or customers of the Company and its Subsidiaries.

(i) The Company's and its Subsidiaries' use and distribution of (i) software developed by or on behalf of the Company or any Subsidiary, and (ii) Open Source Materials, is, to the knowledge of the Company, in material compliance with all Open Source Licenses applicable thereto. Neither the Company nor any Subsidiary has used any Open Source Materials in a manner that requires any material software or Intellectual Property owned by the Company or any of the Company's Subsidiaries to be subject to Copyleft Licenses.

Section 5.22. Privacy and Cybersecurity.

(a) The Company and its Subsidiaries maintain and are in compliance with, and during the last three (3) years have maintained and been in compliance with, (i) all applicable Laws relating to the privacy and/or security of personal information, (ii) the Company's and its Subsidiaries' posted or publicly facing privacy policies, and (iii) the Company's and its Subsidiaries' contractual obligations concerning cybersecurity, data security and the security of the Company's and each of its Subsidiaries' information technology systems, in each case of (i)-(iii) above, other than any non-compliance that, individually or in the aggregate, has not been or would not reasonably be expected to be material to the Company and its Subsidiaries taken as a whole. There are no material Actions by any Person (including any Governmental Authority) pending to which the Company or any of the Company's Subsidiaries is a named party, or as to which the Company or any of its Subsidiaries has received a threat in writing, alleging a violation of any third Person's privacy or personal information rights.

(b) During the last three (3) years (i) there have been, no material breaches of the security of the information technology systems of the Company and its Subsidiaries, and (ii) there have been no disruptions in any information technology systems that materially adversely affected the Company's and its Subsidiaries' business or operations. The Company and its Subsidiaries take commercially reasonable and legally compliant measures designed to protect confidential, sensitive or personally identifiable information in its possession or control against unauthorized access, use, modification, disclosure or other misuse, including through administrative, technical and physical safeguards. To the knowledge of the Company, neither the Company nor any Subsidiary of the Company has (A) experienced any incident in which such information was stolen or improperly accessed, including in connection with a breach of security, or (B) received any written notice or complaint from any Person with respect to any of the foregoing, nor to the knowledge of the Company has any such notice or complaint been threatened in writing against the Company or any of the Company's Subsidiaries.

Section 5.23. Environmental Matters. The Company and its Subsidiaries are and, except for matters which have been fully resolved, have been in material compliance with all Environmental Laws and neither the Company nor any of its Subsidiaries is subject to any current Governmental Order relating to any material non-compliance with Environmental Laws, in each case except as would not be or reasonably be expected to be, individually or in the aggregate, material to the business of the Company and its Subsidiaries, taken as a whole. There has been no material release of any Hazardous Materials by the Company or its Subsidiaries at, in, on or under any Leased Real Property or in connection with the Company's and its Subsidiaries' operations off-site of the Leased Real Property. No material Legal Proceeding is pending or, to the knowledge of the Company, threatened with respect to the Company's and its Subsidiaries' compliance with or liability under Environmental Laws, and, to the knowledge of the Company, there are no facts or circumstances which could reasonably be expected to form the basis of such a Legal Proceeding.

Section 5.24. Absence of Changes. Since the date of the most recent statement of financial position included in the Interim Financial Statements, (i) there has not been any Company Material Adverse Effect; and (ii) except as set forth in Section 5.24 of the Company Disclosure Letter, the Company has, in all material respects, conducted its business and operated its properties in the ordinary course of business consistent with past practice.

Section 5.25. Anti-Corruption Compliance.

(a) Neither the Company nor its Subsidiaries, nor to the knowledge of the Company, any of their directors or officers, any of the Company or its Subsidiaries' respective, employees, agents, Representatives or other Persons acting for or on behalf of the Company or any of its Subsidiaries has, in the past four (4) years: (i) made any bribe, influence payment, kickback, payoff, benefits or any other type of payment (whether tangible or intangible) that would be unlawful under any applicable anti-bribery or anticorruption (governmental or commercial) laws (including, for the avoidance of doubt, any guiding, detailing or implementing regulations), including Laws that prohibit the corrupt payment, offer, promise or authorization of the payment or transfer of anything of value (including gifts or entertainment), directly or indirectly, to any Government Official or commercial entity to obtain a business advantage such as Anti-Bribery Laws; (ii) been in violation of any Anti-Bribery Law, offered, paid, promised to pay, or authorized any payment or transfer of anything of value, directly or indirectly, to any person for the purpose of (A) influencing any act or decision of any Government Official in his official capacity, (B) inducing a Government Official to do or omit to do any act in relation to his lawful duty, (C) securing any improper advantage, (D) inducing a Government Official to influence or affect any act, decision or omission of any Governmental Authority, or (E) assisting the Company or any of its Subsidiaries, or any agent or any other Person acting for or on behalf of the Company or any of its Subsidiaries, in obtaining or retaining business for or with, or in directing business to, any Person; or (iii) accepted or received any contributions, payments, gifts, or expenditures that would be unlawful under any Anti-Bribery Law.

(b) Each of the Company and its Subsidiaries has instituted and maintains policies and procedures reasonably designed to ensure compliance in all material respects with the Anti-Bribery Laws.

(c) As of the date hereof, to the knowledge of the Company, there are no current or pending internal investigations, or third-party investigations (including by any Governmental Authority), or internal or external audits, that address any material allegations or information concerning possible material violations of the Anti-Bribery Laws related to the Company or any of the Company's Subsidiaries.

Section 5.26. Anti-Money Laundering, Sanctions and International Trade Compliance.

(a) The Company and its Subsidiaries, and to the knowledge of the Company, each of their respective directors, officers, employees, agents, Representatives and other Persons acting on behalf of the Company or any of the Company's Subsidiaries (i) are, and have been for the past four (4) years, in compliance with all applicable Anti-Money Laundering Laws, Sanctions, and International Trade Laws, and (ii) have obtained all required licenses, consents, notices, waivers, approvals, orders, registrations, declarations, or other authorizations from, and have made any material filings with, any applicable Governmental Authority for all activities and transactions, including for the import, export, re-export, deemed export, deemed reexport, or transfer required under the International Trade Laws and Sanctions and the provision of financial services required under Anti-Money Laundering Laws. There are and have for the past four (4) years been no pending or, to the knowledge of the Company, threatened, claims, complaints, charges, investigations, voluntary disclosures or Legal Proceedings against the Company or any of the Company's Subsidiaries related to any Anti-Money Laundering Laws, Sanctions, or International Trade Laws.

(b) Neither the Company, any of its Subsidiaries nor, to the knowledge of the Company, any of their respective directors or officers, any employees, agents, Representatives or other Persons acting on behalf of the Company or any of the Company's Subsidiaries, (i) is, or has during the past four (4) years, been a Sanctioned Person or a Restricted Person, or (ii) has transacted business directly or indirectly with any Sanctioned Person or Restricted Person or with or in any Sanctioned Jurisdiction, in each case in violation of applicable Sanctions or International Trade Laws.

(c) The Company and its Subsidiaries have in place written policies, procedures, controls, and systems designed to ensure compliance with all applicable Anti-Money Laundering Laws, Sanctions and International Trade Laws.

Section 5.27. Proxy/Registration Statement. The information supplied by the Company or its Subsidiaries in writing specifically for inclusion in the Proxy/Registration Statement shall not, at (a) the time the Proxy/Registration Statement is filed in accordance with Rule 424(b) and/or pursuant to Section 14A or declared effective, (b) the time the Proxy/Registration Statement (or any amendment thereof or supplement thereto) is first mailed to (i) the Acquiror Shareholders and (ii) the Company Shareholders, and (c) the time of (i) the Acquiror Shareholders' Meeting and (ii) the Company Shareholders' Meeting, contain any untrue statement of a material fact or omit to state any material fact required to be stated therein or necessary in order to make the statements therein, in light of the circumstances under which they were made, not misleading.

Section 5.28. Vendors.

(a) Section 5.28(a) of the Company Disclosure Letter sets forth, as of the date of this Agreement, the top 5 vendors based on the aggregate Dollar value of the Company's and its Subsidiaries' transaction volume with such counterparty for the fiscal year of the Company ended June 30, 2021 and June 30, 2022 (the "Top Vendors").

(b) None of the Top Vendors has, as of the date of this Agreement, informed in writing any of the Company or any of the Company's Subsidiaries that it will, or, to the knowledge of the Company, has threatened to, terminate, cancel, or materially limit or materially and adversely modify any of its existing business with the Company or any of the Company's Subsidiaries (other than due to the expiration of an existing contractual arrangement), and to the knowledge of the Company, none of the Top Vendors is, as of the date of this Agreement, otherwise involved in or threatening a material dispute against the Company or its Subsidiaries or their respective businesses.

Section 5.29. Government Contracts. The Company is not party to (a) any Contract, including an individual task order, delivery order, purchase order, basic ordering agreement, letter Contract or blanket purchase agreement between the Company or any of its Subsidiaries, on one hand, and any Governmental Authority, on the other hand, or (b) any subcontract or other Contract by which the Company or any of its Subsidiaries has agreed to provide goods or services through a prime contractor directly to a Governmental Authority that is expressly identified in such subcontract or other Contract as the ultimate consumer of such goods or services.

Section 5.30. Sufficiency of Assets. Except as would not be expected to be material to the business of the Company and its Subsidiaries, taken as a whole, the tangible and intangible assets owned, licensed or leased by the Company and its Subsidiaries constitute all of the assets reasonably necessary for the continued conduct of the business of the Company and its Subsidiaries after the Share Exchange Closing in the ordinary course of business as of the date hereof.

Section 5.31. Investment Company. The Company is not an "investment company" or a Person directly or indirectly "controlled" by or acting on behalf of an "investment company", in each case within the meaning of the Investment Company Act.

Section 5.32. Brokers' Fees. No broker, finder or investment banker is entitled to any brokerage fee, finders' fee or other brokerage commission in connection with the transactions contemplated hereby based upon arrangements made by the Company or any of the Company's Subsidiaries' with respect to which the Company or any of the Company's Subsidiaries has any obligation.

Section 5.33. No Additional Representations or Warranties. Except as provided in this Agreement and any Transaction Document to which the Company or any of Affiliates is a party, neither the Company, nor any of its Affiliates, nor any of their respective directors, commissioners, managers, officers, employees, equityholders, partners, members or Representatives has made, or is making, any representation or warranty whatsoever to Acquiror or its Affiliates.

Section 5.34. Investigation. Notwithstanding anything contained in this Agreement, each of the Company, its Subsidiaries and Company Shareholders has made its own investigation of Acquiror and acknowledges that neither Acquiror nor any of its equityholders, partners, members and Representatives, including any of the Sponsor and its Affiliates, is making any representation or warranty whatsoever, express or implied, other than those expressly given by Acquiror in Article VI.



## ARTICLE VI

### **REPRESENTATIONS AND WARRANTIES OF ACQUIROR**

Except as set forth in (a) any Acquiror SEC Filings publicly available on or prior to the date hereof (excluding (i) any disclosures in any risk factors section that do not constitute statements of fact or factual matters, disclosures in any forward-looking statements disclaimer and other disclosures that are generally cautionary, predictive or forward-looking in nature and (ii) any exhibits or other documents appended thereto), and (b) the disclosure letter delivered by Acquiror to the Company (the "Acquiror Disclosure Letter"), Acquiror represents and warrants to the Company and the Sellers as of the date hereof, the Merger Effective Time and the Share Exchange Closing as follows:

Section 6.1. Acquiror Organization. Acquiror has been duly incorporated, organized or formed and is validly existing as a corporation or exempted company in good standing (or equivalent status, to the extent that such concept exists) under the Laws of its jurisdiction of incorporation, organization or formation, and has the requisite company power and authority to own, lease or operate all of its properties and assets and to conduct its business as it is now being conducted. The copies of Acquiror's Governing Documents, as amended to the date of this Agreement, previously delivered by Acquiror to the Company and the Sellers, are true, correct and complete. Acquiror is duly licensed or qualified and in good standing as a foreign corporation or company in all jurisdictions in which its ownership of property or the character of its activities is such as to require it to be so licensed or qualified, except where the failure to be so licensed or qualified would not, individually or in the aggregate, have or reasonably be expected to have, a material adverse effect on Acquiror.

Section 6.2. Due Authorization.

(a) Acquiror has all requisite corporate power and authority to (i) execute and deliver this Agreement, the other Transaction Documents to which Acquiror is a party and the documents contemplated hereby and thereby, and (ii) consummate the transactions contemplated hereby and thereby and perform all obligations to be performed by it hereunder and thereunder. The execution and delivery of this Agreement, the other Transaction Documents to which Acquiror is a party and the documents contemplated hereby and thereby and the consummation of the transactions contemplated hereby and thereby have been (A) duly and validly authorized and approved by the board of directors of Acquiror and (B) determined by the board of directors of Acquiror as advisable to Acquiror and the Acquiror Shareholders and recommended for approval by the Acquiror Shareholders. No other company proceeding on the part of Acquiror is necessary to authorize this Agreement and the documents contemplated hereby (other than the Acquiror Shareholder Approval). This Agreement has been, and at or prior to the Share Exchange Closing, the other documents contemplated hereby will be, duly and validly executed and delivered by any Acquiror Party, and this Agreement constitutes, and at or prior to the Share Exchange Closing, the other Transaction Documents to which Acquiror Party is a party and the other documents contemplated hereby and thereby will constitute, a legal, valid and binding obligation of Acquiror, enforceable against Acquiror in accordance with its terms, subject to applicable bankruptcy, insolvency, fraudulent conveyance, reorganization, moratorium and similar Laws affecting creditors' rights generally and subject, as to enforceability, to general principles of equity.

(b) The votes on the Transaction Proposals as identified in the Proxy/Registration Statement described in Section 10.2(a)(i) by holders of Acquiror Common Stock (which include the Acquiror Shareholder Approval) are the only votes of the holders of any of Acquiror's Securities that are necessary in connection with entry into this Agreement by Acquiror and the consummation of the transactions contemplated hereby, including the Merger Closing and the Share Exchange Closing.

Section 6.3. No Conflict. Subject to the Acquiror Shareholder Approval, the execution and delivery of this Agreement by Acquiror Party, the other Transaction Documents to which Acquiror is a party and the other documents contemplated hereby and thereby and the consummation of the transactions contemplated hereby and thereby do not and will not (a) violate or conflict with any provision of, or result in the breach of or default under the Governing Documents of Acquiror, (b) violate or conflict with any provision of, or result in the breach of, or default under any applicable Law or Governmental Order applicable to Acquiror, (c) violate or conflict with any provision of, or result in the breach of, result in the loss of any right or benefit, or cause acceleration, or constitute (with or without due notice or lapse of time or both) a default (or give rise to any right of termination, cancellation or acceleration) under any Contract to which Acquiror is a party or by which Acquiror may be bound, or terminate or result in the termination of any such Contract or (d) result in the creation of any Lien (other than Permitted Liens) upon any of the properties or assets of Acquiror, except, in the case of clauses (b) through (d), to the extent that the occurrence of the foregoing does not or would not, individually or in the aggregate, prevent or materially adversely affect the ability of Acquiror to consummate the Transactions.

Section 6.4. Litigation and Proceedings. As of the date hereof (a) there are no pending or, to the knowledge of Acquiror, threatened Legal Proceedings against Acquiror or its properties or assets; and (b) there is no outstanding Governmental Order imposed upon Acquiror, nor are any properties or assets of Acquiror or its business bound or subject to any Governmental Order, except, in each case, as would not, individually or in the aggregate, be or reasonably be expected to be material to the business of Acquiror.

Section 6.5. SEC Filings. Acquiror has timely filed or furnished all statements, prospectuses, registration statements, forms, reports and documents required to be filed by it with the SEC since May 12, 2022, pursuant to the Exchange Act or the Securities Act (collectively, as they have been amended since the time of their filing through the date hereof, the "Acquiror SEC Filings"). Each of the Acquiror SEC Filings, as of the respective date of its filing (or if amended or superseded by a filing prior to the date of this Agreement or the Share Exchange Closing Date, then on the date of such filing), complied in all material respects with the applicable requirements of the Securities Act, the Exchange Act, the Sarbanes-Oxley Act and any rules and regulations promulgated thereunder applicable to the Acquiror SEC Filings. As of the respective date of its filing (or if amended or superseded by a filing prior to the date of this Agreement or the Share Exchange Closing Date, then on the date of such filing), the Acquiror SEC Filings did not contain any untrue statement of a material fact or omit to state a material fact required to be stated therein or necessary to make the statements made therein, in light of the circumstances under which they were made, not misleading. As of the date hereof, there are no outstanding or unresolved comments in comment letters received from the SEC with respect to the Acquiror SEC Filings. None of the Acquiror SEC Filings filed on or prior to the date hereof is subject to ongoing SEC review or, to the knowledge of Acquiror, investigation as of the date hereof. There has been no amendment to the letter agreement entered into by and among Acquiror and Prime Number Capital LLC as the underwriter relating to Acquiror IPO dated May 12, 2022 and such letter agreement is (i) in full force and effect and (ii) represents the legal, valid and binding obligations of Acquiror and, to the knowledge of Acquiror, represents the legal, valid and binding obligations of the other parties thereto.

Section 6.6. Internal Controls; Listing; Financial Statements.

(a) Except as not required in reliance on exemptions from various reporting requirements by virtue of Acquiror's status as an "emerging growth company" within the meaning of the Securities Act, as modified by the JOBS Act or as otherwise set forth in the Acquiror SEC Filings, Acquiror has established and maintains disclosure controls and procedures (as defined in Rule 13a-15 under the Exchange Act). Such disclosure controls and procedures are designed to (i) ensure that material information relating to Acquiror, including its consolidated Subsidiaries, if any, is made known to Acquiror's principal executive officer and its principal financial officer by others within those entities, particularly during the periods in which the periodic reports required under the Exchange Act are being prepared; and (ii) be effective in timely alerting Acquiror's principal executive officer and principal financial officer to material information required to be included in Acquiror's periodic reports required under the Exchange Act. Acquiror has established and maintained a system of internal controls over financial reporting (as defined in Rule 13a-15 under the Exchange Act) which is reasonably sufficient to provide reasonable assurance regarding the reliability of Acquiror's financial reporting and the preparation of Acquiror Financial Statements for external purposes in accordance with GAAP.

(b) To the knowledge of Acquiror, except as set forth in Section 6.6(b) of the Acquiror Disclosure Letter, each director and executive officer of Acquiror has filed with the SEC on a timely basis all statements required by Section 16(a) of the Exchange Act and the rules and regulations promulgated thereunder.

(c) The Acquiror SEC Filings contain true and complete copies of the audited balance sheet as of May 17, 2022, and statement of operations, cash flow and shareholders' equity of Acquiror for the period from February 25, 2021 (inception) through May 17, 2022, together with the auditor's reports thereon (the "Acquiror Financial Statements"). Except as disclosed in the Acquiror SEC Filings, the Acquiror Financial Statements (i) fairly present in all material respects the financial position of Acquiror, as at the respective dates thereof, and the results of operations and consolidated cash flows for the respective periods then ended, (ii) were prepared in conformity with GAAP applied on a consistent basis during the periods involved (except as may be indicated therein or in the notes thereto), and (iii) comply in all material respects with the applicable accounting requirements and with the rules and regulations of the SEC, the Exchange Act and the Securities Act in effect as of the respective dates thereof. The books and records of Acquiror have been, and are being, maintained in all material respects in accordance with GAAP and any other applicable legal and accounting requirements.

(d) There are no outstanding loans or other extensions of credit made by Acquiror to any executive officer (as defined in Rule 3b-7 under the Exchange Act) or director of Acquiror. Acquiror has not taken any action prohibited by Section 402 of the Sarbanes-Oxley Act.

(e) Neither Acquiror nor any director or officer of Acquiror nor, to the knowledge of Acquiror, any employee of Acquiror or Acquiror's independent auditors has identified or been made aware of (i) any significant deficiency or material weakness in the system of internal accounting controls utilized by Acquiror, (ii) any fraud, whether or not material, that involves Acquiror's management or other employees who have a role in the preparation of financial statements or the internal accounting controls utilized by Acquiror or (iii) any claim or allegation regarding any of the foregoing.

Section 6.7. Governmental Authorities; Consents Assuming the truth and completeness of the representations and warranties of the Sellers, the Company and the Acquisition Entities contained in this Agreement, no consent, waiver, approval or authorization of, or designation, declaration or filing with, or notification to, any Governmental Authority is required on the part of Acquiror with respect to Acquiror's execution or delivery of this Agreement or the consummation of the transactions contemplated hereby, except (a) for any consents, approvals, authorizations, designations, declarations, waivers or filings, the absence of which would not, individually or in the aggregate, have, or reasonably be expected to have, a material adverse effect on the ability of Acquiror to enter into and perform its obligations under this Agreement, (b) the filing of the Proxy/Registration Statement with the SEC and (c) the filing of the Certificate of Merger with the Secretary of State of the State of Delaware, in accordance with the relevant provisions of the Delaware Act.

Section 6.8. Trust Account. As of the date of this Agreement, Acquiror has at least \$65,790,000 in the Trust Account (including \$2,257,500 payable for deferred underwriting commissions), such monies invested in United States government securities or money market funds meeting certain conditions under Rule 2a-7 promulgated under the Investment Company Act pursuant to the Investment Management Trust Agreement, dated as of May 12, 2022, between Acquiror and Wilmington Trust, National Association, as trustee (the “Trustee”) (the “Trust Agreement”). There are no separate Contracts (whether written or unwritten, express or implied) that would cause the description of the Trust Agreement in the Acquiror SEC Filings to be inaccurate or that would entitle any Person (other than shareholders of Acquiror holding Acquiror Common Stock initially sold in Acquiror’s initial public offering who shall have elected to redeem their Acquiror Common Stock pursuant to Acquiror’s Governing Documents and the underwriters of Acquiror’s initial public offering with respect to deferred underwriting commissions) to any portion of the proceeds in the Trust Account. Prior to the Share Exchange Closing, none of the funds held in the Trust Account may be released other than to pay Taxes and payments with respect to all Acquiror Share Redemptions. There are no claims or proceedings pending or, to the knowledge of Acquiror, threatened with respect to the Trust Account. Acquiror has performed all material obligations required to be performed by it to date under, and is not in default, in breach or delinquent in performance or any other respect (to the knowledge of Acquiror, claimed or actual) in connection with, the Trust Agreement, and no event has occurred which, with due notice or lapse of time or both, would constitute such a default or breach thereunder. As of the Share Exchange Closing, the obligations of Acquiror to dissolve or liquidate pursuant to Acquiror’s Governing Documents shall terminate, and as of the Share Exchange Closing, Acquiror shall have no obligation whatsoever pursuant to Acquiror’s Governing Documents to dissolve and liquidate the assets of Acquiror by reason of the consummation of the transactions contemplated hereby (other than use of the funds in the Trust Account for Acquiror Share Redemptions and to pay the underwriters of Acquiror’s initial public offering with respect to deferred underwriting commissions). To the knowledge of Acquiror, as of the date hereof, following the Share Exchange Closing, no Acquiror Shareholder shall be entitled to receive any amount in the Trust Account except to the extent such Acquiror Shareholder has exercised an Acquiror Share Redemption. As of the date hereof, assuming the accuracy of the representations and warranties of the Company contained herein and the compliance by the Company with its obligations hereunder, Acquiror does not have any reason to believe that any of the conditions to the use of funds in the Trust Account will not be satisfied or funds available in the Trust Account will not be available to Acquiror on the Share Exchange Closing Date (other than use of the funds in the Trust Account for Acquiror Share Redemptions and to pay the underwriters of Acquiror’s initial public offering with respect to deferred underwriting commissions).

Section 6.9. Investment Company Act; JOBS Act. Acquiror is not an “investment company” or a Person directly or indirectly “controlled” by or acting on behalf of an “investment company”, in each case within the meaning of the Investment Company Act. Acquiror constitutes an “emerging growth company” within the meaning of the JOBS Act.

Section 6.10. Absence of Changes. Since May 17, 2022, (a) there has not been any event or occurrence that has, or would reasonably be expected to, individually or in the aggregate, prevent or materially adversely affect the ability of Acquiror to consummate the Transactions and (b) Acquiror has, in all material respects, conducted its business and operated its properties in the ordinary course of business consistent with past practice.

Section 6.11. No Undisclosed Liabilities. Except for any Acquiror Transaction Expenses, there is no liability, debt or obligation of or claim or judgment against Acquiror (whether direct or indirect, absolute or contingent, accrued or unaccrued, known or unknown, liquidated or unliquidated, or due or to become due), except for liabilities and obligations (a) reflected or reserved for on the financial statements or disclosed in the notes thereto included in Acquiror SEC Filings, (b) that have arisen since the date of the most recent balance sheet included in the Acquiror SEC Filings in the ordinary course of business of Acquiror, or (c) which would not be, or would not reasonably be expected to be, material to the business of Acquiror.

Section 6.12. Capitalization of Acquiror.

(a) As of the date of this Agreement, the authorized share capital of Acquiror consists of (i) 400,000 shares of Acquiror Preferred Stock, none of which is issued or outstanding as of the date of this Agreement, (ii) 20,000,000 shares of Acquiror Class A Common Stock, 8,461,392 of which are issued and outstanding as of the date of this Agreement, (iii) 100,000 shares of Acquiror Class B Common Stock, none of which is issued or outstanding as of the date of this Agreement. The foregoing represents all of the issued and outstanding shares of Acquiror Stock as of the date of this Agreement. All issued and outstanding shares of Acquiror Stock (i) have been duly authorized and validly issued and are fully paid and non-assessable; (ii) have been offered, sold and issued in compliance with applicable Law, including federal and state securities Laws, and all requirements set forth in (1) Acquiror's Governing Documents, and (2) any other applicable Contracts governing the issuance of such securities; and (iii) are not subject to, nor have they been issued in violation of, any purchase option, call option, right of first refusal, preemptive right, subscription right or any similar right under any provision of any applicable Law, Acquiror's Governing Documents or any Contract to which Acquiror is a party or otherwise bound.

(b) As of the date of this Agreement, 3,225,000 Acquiror Warrants are issued and outstanding. No warrant to purchase Acquiror Common Stock has been issued other than those included in the Acquiror Units issued in the Acquiror IPO. As of the date of this Agreement, 6,450,000 Acquiror Rights are issued and outstanding. No Sponsor holds any Acquiror Right. All outstanding Acquiror Warrants and Acquiror Rights (i) have been duly authorized and validly issued and constitute valid and binding obligations of Acquiror, enforceable against Acquiror in accordance with their terms, subject to applicable bankruptcy, insolvency, fraudulent conveyance, reorganization, moratorium and similar Laws affecting creditors' rights generally and subject, as to enforceability, to general principles of equity; (ii) have been offered, sold and issued in compliance with applicable Law, including federal and state securities Laws, and all requirements set forth in (1) Acquiror's Governing Documents and (2) any other applicable Contracts governing the issuance of such securities; and (iii) are not subject to, nor have they been issued in violation of, any purchase option, call option, right of first refusal, preemptive right, subscription right or any similar right under any provision of any applicable Law, Acquiror's Governing Documents or any Contract to which Acquiror is a party or otherwise bound. Except for the Acquiror's Governing Documents and this Agreement, there are no outstanding Contracts of Acquiror to repurchase, redeem or otherwise acquire any Acquiror Securities.

(c) Except as contemplated by this Agreement or the other documents contemplated hereby, Acquiror has not granted any outstanding options, warrants, rights or other securities convertible, exercisable or exchangeable for Acquiror Securities, or any other commitments or agreements providing for the issuance of additional Equity Securities, for the repurchase or redemption of any Equity Securities or the value of which is determined by reference to the Equity Securities of Acquiror, and there are no Contracts of any kind which may obligate Acquiror to issue, purchase, redeem or otherwise acquire any Equity Securities of Acquiror.

(d) Acquiror has no Subsidiaries, and does not own, directly or indirectly, any equity interests or other interests or investments (whether equity or debt) in any Person, whether incorporated or unincorporated. Acquiror is not party to any Contract that obligates Acquiror to invest money in, loan money to or make any capital contribution to any other Person.

Section 6.13. Brokers' Fees. Except as set forth in Section 6.13 of the Acquiror Disclosure Letter, no broker, finder, investment banker or other Person is entitled to any brokerage fee, finders' fee or other commission in connection with the transactions contemplated hereby based upon arrangements made by Acquiror or any of its Affiliates.

Section 6.14. Indebtedness. Except as set forth in Acquiror Financial Statements or as permitted by Section 9.4 after the date hereof, Acquiror does not have any Indebtedness.

Section 6.15. Taxes.

(a) All material Tax Returns required to be filed by or with respect to Acquiror have been timely filed (taking into account any applicable extensions), all such Tax Returns (taking into account all amendments thereto) are true, correct and complete in all material respects and all material Taxes due and payable (whether or not shown on any Tax Return) have been paid.

(b) Acquiror has withheld from amounts owing to any employee, creditor or other Person all material Taxes required by Law to be withheld, paid over to the proper Governmental Authority in a timely manner all such withheld amounts required to have been so paid over and complied in all material respects with all applicable withholding and related reporting requirements with respect to such Taxes.

(c) There are no Liens for any material Taxes (other than Permitted Liens) upon the property or assets of Acquiror.

(d) No claim, assessment, deficiency or proposed adjustment for any material amount of Tax has been asserted in writing or assessed by any Governmental Authority against Acquiror that remains unpaid.

(e) There is no material Tax audit or other examination of Acquiror presently in progress with respect to any material Taxes, nor has Acquiror been notified in writing of any request or threat for such an audit or other examination, and there are no waivers, extensions or written requests for any waivers or extensions of any statute of limitations currently in effect with respect to any material Taxes of Acquiror.

(f) The Acquiror has not made a request for or entered into a closing agreement, private letter ruling, advance tax ruling or similar agreement with any Governmental Authority with respect to Taxes. The Acquiror has not made a change of any method of accounting with respect to any Taxes.

(g) The Acquiror is not a party to any Tax indemnification or Tax sharing or similar Tax agreement (other than any customary commercial Contracts (or Contracts entered into in the ordinary course of business) not primarily related to Taxes).

(h) The Acquiror has not been a party to any transaction treated by the parties as a distribution of stock qualifying for Tax-free treatment under Section 355 of the Code in the two (2) years prior to the date of this Agreement.

(i) The Acquiror (i) is not liable for Taxes of any other Person under Treasury Regulation Section 1.1502-6 or any similar provision of state, local or foreign Tax Law or as a transferee or successor or by Contract (other than customary commercial Contracts (or Contracts entered into in the ordinary course of business) not primarily related to Taxes) or (ii) has never been a member of an affiliated, consolidated, combined or unitary group filing for U.S. federal, state or local income Tax purposes, other than a group the common parent of which was or is the Acquiror.

(j) Since its inception, no written claim has been made by any Governmental Authority where the Acquiror does not file Tax Returns that it is or may be subject to taxation in that jurisdiction.

(k) The Acquiror has not participated in a "listed transaction" within the meaning of Treasury Regulation 1.6011-4(b)(2).

(l) Except as contemplated by this Agreement and the Transactions, Acquiror has not taken any action or agreed to take any action, nor to the knowledge of Acquiror are there any facts or circumstances, that could reasonably be expected to prevent the Transactions from qualifying for the Intended Tax Treatment.



Section 6.16. Business Activities.

(a) Since formation, Acquiror has not conducted any business activities other than activities related to Acquiror's initial public offering or directed toward the accomplishment of a Business Combination. Except as set forth in Acquiror's Governing Documents or as otherwise contemplated by this Agreement or the other Transaction Documents and the transactions contemplated hereby and thereby, there is no agreement, commitment, or Governmental Order binding upon Acquiror or to which Acquiror is a party which has or would reasonably be expected to have the effect of prohibiting or impairing any business practice of Acquiror or any acquisition of property by Acquiror or the conduct of business by Acquiror as currently conducted or as contemplated to be conducted as of the Share Exchange Closing, other than such effects, individually or in the aggregate, which have not been and would not reasonably be expected to be material to Acquiror.

(b) Except for the transactions contemplated by this Agreement and the other Transaction Documents, Acquiror does not own or have a right to acquire, directly or indirectly, any interest or investment (whether equity or debt) in any corporation, partnership, joint venture, business, trust or other entity. Except for this Agreement and the other Transaction Documents and the transactions contemplated hereby and thereby, Acquiror has no material interests, rights, obligations or liabilities with respect to, and is not party to or bound by, and does not have its assets or property subject to, in each case whether directly or indirectly, any Contract or transaction which is, or would reasonably be interpreted as constituting, a Business Combination.

(c) Except for this Agreement and the other Transaction Documents to which it is party and the other documents and transactions contemplated hereby and thereby (including with respect to Acquiror Transaction Expenses) and contracts with the underwriters of Acquiror's initial public offering, Acquiror is not party to any Contract with any other Person that would require payments by Acquiror after the date hereof in excess of \$100,000 in the aggregate with respect to any individual Contract (or in the aggregate with any series of related Contracts) other than Working Capital Loans. As of the date of this Agreement, Acquiror does not have any Working Capital Loan.

Section 6.17. Nasdaq Stock Market Quotation. The shares of Acquiror Common Stock are registered pursuant to Section 12(b) of the Exchange Act with the Nasdaq Stock Market LLC ("Nasdaq") and are listed for trading on Nasdaq Global Market under the symbol "PNAC"; the Acquiror Public Warrants are registered pursuant to Section 12(b) of the Exchange Act and are listed for trading on Nasdaq under the symbol "PNACW"; the Acquiror Rights are registered pursuant to Section 12(b) of the Exchange Act and are listed for trading on Nasdaq under the symbol "PNACR"; the Acquiror Units are registered pursuant to Section 12(b) of the Exchange Act and are listed for trading on Nasdaq under the symbol "PNACU". Acquiror is in compliance in all material respects with the rules of Nasdaq and there is no Action or proceeding pending or, to the knowledge of Acquiror, threatened against Acquiror by Nasdaq or the SEC with respect to any intention by such entity to deregister the Acquiror Common Stock, the Acquiror Public Warrants, the Acquiror Rights or the Acquiror Units or terminate the listing thereof on Nasdaq. None of Acquiror nor any of its Affiliates or Representatives has taken any action to terminate the registration of the Acquiror Common Stock, the Acquiror Public Warrants and the Acquiror Rights or the Acquiror Units under the Exchange Act except as expressly contemplated by this Agreement or any other Transaction Document.

Section 6.18. Proxy/Registration Statement. The information supplied by Acquiror Party in writing specifically for inclusion in the Proxy/Registration Statement shall not, at (a) the time the Proxy/Registration Statement is filed in accordance with Rule 424(b) and/or pursuant to Section 14A or declared effective, (b) the time the Proxy/Registration Statement (or any amendment thereof or supplement thereto) is first mailed to (i) the Acquiror Shareholders and (ii) the Company Shareholders, and (c) the time of (i) the Acquiror Shareholders' Meeting and (ii) a Seller, contain any untrue statement of a material fact or omit to state any material fact required to be stated therein or necessary in order to make the statements therein, in light of the circumstances under which they were made, not misleading.

Section 6.19. Transaction Financing. The Transaction Financing Agreements, when entered into by the PubCo and the investors in the Transaction Financing prior to the Share Exchange Closing, shall be in full force and effect with respect to, and binding on, Acquiror, and to the knowledge of Acquiror, on each investor thereto, in accordance with their terms.

Section 6.20. No Outside Reliance. Notwithstanding anything contained in this Article VI or any other provision hereof, each of Acquiror and any of its respective directors, managers, officers, employees, equityholders, partners, members or Representatives acknowledge and agree that Acquiror has made its own investigation of the Company and that neither the Company nor any of its Affiliates, agents or Representatives is making any representation or warranty whatsoever, express or implied, other than those expressly given by the Company in Article V and the Sellers in Article IV, including any implied warranty or representation as to condition, merchantability, suitability or fitness for a particular purpose or trade as to any of the assets of the Company or its Subsidiaries. Without limiting the generality of the foregoing, it is understood that any cost estimates, financial or other projections or other predictions that may be contained or referred to in the Company Disclosure Letter or elsewhere, as well as any information, documents or other materials (including any such materials contained in any "data room" (whether or not accessed by Acquiror or its Representatives) or reviewed by Acquiror Party or any of its Affiliates or its Representatives) or management presentations that have been or shall hereafter be provided to Acquiror Party or any of its Affiliates or Representatives are not and will not be deemed to be representations or warranties of the Company or any Seller, and no representation or warranty is made as to the accuracy or completeness of any of the foregoing except as may be expressly set forth in Article V and Article IV of this Agreement. Except as otherwise expressly set forth in this Agreement, Acquiror understands and agrees that any assets, properties and business of the Company and its Subsidiaries are furnished "as is", "where is" and subject to and except as otherwise provided in the representations and warranties contained in Article V and Article IV, with all faults and without any other representation or warranty of any nature whatsoever.

Section 6.21. No Additional Representation or Warranties. Except as expressly provided in this Article VI and Article VII, none of Acquiror, any of its Affiliates, or any of their respective directors, managers, officers, employees, shareholders, partners, members or Representatives has made, or is making, any representation or warranty whatsoever to the Company, any Seller or its respective Affiliates, and no such party shall be liable in respect of the accuracy or completeness of any information provided to the Company, any Seller or its respective Affiliates. Without limiting the foregoing, the Company acknowledges that the Company and its advisors, have made their own investigation of Acquiror and each Acquisition Entity and, except as provided in this Agreement, are not relying on any representation or warranty whatsoever as to the condition, merchantability, suitability or fitness for a particular purpose or trade as to any of the assets of Acquiror or any Acquiror Entity, the prospects (financial or otherwise) or the viability or likelihood of success of the business of Acquiror or any Acquiror Entity as conducted after the Share Exchange Closing, as contained in any materials provided by Acquiror or any of its Affiliates or any of their respective directors, officers, employees, shareholders, partners, members or Representatives or otherwise.

## ARTICLE VII

### REPRESENTATIONS AND WARRANTIES OF THE ACQUISITION ENTITIES

The Acquisition Entities (with respect to PubCo and New SubCo, as of the date each of which delivered its signature page hereto) jointly and severally represent and warrant to the Company and the Sellers as of the date hereof and as of the Share Exchange Closing, as follows:

Section 7.1. Organization. Such Acquisition Entity has been duly incorporated, organized or formed and is validly existing as a corporation or exempted company in good standing (or equivalent status, to the extent that such concept exists) under the Laws of its jurisdiction of incorporation, organization or formation, and has the requisite company power and authority to own, lease or operate all of its properties and assets and to conduct its business as it is now being conducted. The copies of such Acquisition Entity's Governing Documents, as amended to the date of this Agreement, previously delivered by such Acquisition Entity to the Company and Acquiror, are true, correct and complete. Such Acquisition Entity is duly licensed or qualified and in good standing as a foreign corporation or company in all jurisdictions in which its ownership of property or the character of its activities is such as to require it to be so licensed or qualified, except where the failure to be so licensed or qualified would not reasonably be expected to be, individually or in the aggregate, material to such Acquisition Entity.

Section 7.2. Due Authorization. Such Acquisition Entity has all requisite corporate power and authority to (a) execute and deliver this Agreement, the other Transaction Documents to which such Acquisition Entity is a party and the documents contemplated hereby and thereby, and (b) consummate the transactions contemplated hereby and thereby and perform all obligations to be performed by it hereunder and thereunder. The execution and delivery of this Agreement, the other Transaction Documents to which such Acquisition Entity is a party, and the documents contemplated hereby and the consummation of the transactions contemplated hereby and thereby have been (i) duly and validly authorized and approved by the board of directors of such Acquisition Entity and (ii) determined by the board of directors of such Acquisition Entity as advisable to such Acquisition Entity and such Acquisition Entity's shareholders and recommended for approval by such Acquisition Entity's shareholders. No other company proceeding on the part of such Acquisition Entity is necessary to authorize this Agreement or the other Transaction Documents to which such Acquisition Entity is a party and the documents contemplated hereby and thereby. This Agreement has been, and at or prior to the Share Exchange Closing, the other Transaction Documents to which such Acquisition Entity is a party will be, duly and validly executed and delivered by such Acquisition Entity, and this Agreement constitutes, and at or prior to the Share Exchange Closing, the other Transaction Documents to which such Acquisition Entity is a party will constitute, a legal, valid and binding obligation of such Acquisition Entity, enforceable against such Acquisition Entity in accordance with its terms, subject to applicable bankruptcy, insolvency, fraudulent conveyance, reorganization, moratorium and similar Laws affecting creditors' rights generally and subject, as to enforceability, to general principles of equity.

Section 7.3. No Conflict. The execution and delivery of this Agreement and the other Transaction Documents to which such Acquisition Entity is a party by such Acquisition Entity and the consummation of the transactions contemplated hereby and thereby do not and will not (a) violate or conflict with any provision of, or result in the breach of or default under the Governing Documents of such Acquisition Entity, (b) violate or conflict with any provision of, or result in the breach of, or default under any applicable Law or Governmental Order applicable to such Acquisition Entity, (c) violate or conflict with any provision of, or result in the breach of, result in the loss of any right or benefit, or cause acceleration, or constitute (with or without due notice or lapse of time or both) a default (or give rise to any right of termination, cancellation or acceleration) under any Contract to which such Acquisition Entity is a party or by which such Acquisition Entity may be bound, or terminate or result in the termination of any such Contract or (d) result in the creation of any Lien upon any of the properties or assets of such Acquisition Entity, except, in the case of clauses (b) through (d), to the extent that the occurrence of the foregoing does not or would not reasonably be expected to, individually or in the aggregate, prevent or materially adversely affect the ability of such Acquisition Entity to consummate the Transactions.

Section 7.4. Litigation and Proceedings. As of the date hereof (a) there are no pending or, to the knowledge of such Acquisition Entity, threatened Legal Proceedings against such Acquisition Entity, its properties or assets; and (b) there is no outstanding Governmental Order imposed upon such Acquisition Entity, nor are any properties or assets of such Acquisition Entity or its business bound or subject to any Governmental Order, except, in each case, as would not be, or reasonably be expected to be, material to the business of such Acquisition Entity.

Section 7.5. Governmental Authorities; Consents. Assuming the truth and completeness of the representations and warranties of the Company, the Sellers and Acquiror contained in this Agreement, no consent, waiver, approval or authorization of, or designation, declaration or filing with, or notification to, any Governmental Authority or other Person is required on the part of such Acquisition Entity with respect to such Acquisition Entity's execution or delivery of this Agreement or the consummation of the transactions contemplated hereby, except for the filing of the Proxy/Registration Statement with the SEC, and the Post-Combination PubCo Charter with the Cayman Registrar, and any consents, approvals, authorizations, designations, declarations, waivers or filings, the absence of which would not, individually or in the aggregate, have, or reasonably be expected to have, a material adverse effect on the ability of such Acquisition Entity to enter into and perform its obligations under this Agreement.

Section 7.6. Capitalization of Acquisition Entities. As of the date of this Agreement, (a) the authorized share capital of PubCo consists of 500,000,000 ordinary shares, par value \$0.0001 each, one (1) of which is issued and outstanding as of the date of this Agreement, (b) New SubCo is authorized to issue only ordinary shares of New SubCo, all of which are owned by PubCo, and (c) Merger Sub is authorized to issue only shares of common stock of Merger Sub, all of which are issued and outstanding and all of which are owned by PubCo. Prior to giving effect to the transactions contemplated by this Agreement, except for New SubCo and Merger Sub, PubCo has no Subsidiaries, and does not own, directly or indirectly, any equity interests or other interests or investments (whether equity or debt) in any Person, whether incorporated or unincorporated. Prior to giving effect to the transactions contemplated by this Agreement, neither New SubCo nor Merger Sub has any Subsidiary or owns directly or indirectly, any equity interests or other interests or investments (whether equity or debt) in any Person, whether incorporated or unincorporated. No Acquisition Entity is a party to any Contract that obligates PubCo, Merger Sub or New SubCo to invest money in, loan money to or make any capital contribution to any other Person.

Section 7.7. Brokers' Fees. No broker, finder, investment banker or other Person is entitled to any brokerage fee, finders' fee or other commission in connection with the transactions contemplated hereby based upon arrangements made by such Acquisition Entity.

Section 7.8. Business Activities. Since formation, such Acquisition Entity has not conducted any business activities other than those directed toward the consummation of the Transactions. Except as set forth in such Acquisition Entity's Governing Documents or as otherwise contemplated by this Agreement or the other Transaction Documents and the transactions contemplated hereby and thereby, there is no agreement, commitment, or Governmental Order binding upon such Acquisition Entity or to which such Acquisition Entity is a party which has or would reasonably be expected to have the effect of prohibiting or impairing any business practice of such Acquisition Entity or any acquisition of property by such Acquisition Entity or the conduct of business by such Acquisition Entity as currently conducted or as contemplated to be conducted as of the Share Exchange Closing, other than such effects, individually or in the aggregate, which have not been and would not reasonably be expected to be material to such Acquisition Entity.

Section 7.9. Consideration Shares. The Aggregate Merger Consideration and Aggregate Exchange Consideration, when issued in accordance with the terms hereof, shall be duly authorized and validly issued and allotted, fully paid and non-assessable and issued or allotted in compliance with all applicable Law, including state and federal securities Laws, and not subject to, and not issued in violation of, any Lien, purchase option, call option, right of first refusal, preemptive right, subscription right or any similar right under any provision of applicable Law, PubCo's Governing Documents, or any Contract to which PubCo is a party or otherwise bound.

Section 7.10. Foreign Private Issuer and Emerging Growth Company. Prior to giving effect to the transactions contemplated by this Agreement, other than New SubCo and Merger Sub, PubCo does not have any Subsidiaries or own any equity interests in any other Person. PubCo is and shall be at all times commencing from the date thirty (30) days prior to the first filing of the Proxy/Registration Statement with the SEC through the Share Exchange Closing, (a) a foreign private issuer as defined in Rule 405 under the Securities Act and (b) an "emerging growth company" as that term is defined in the JOBS Act.

Section 7.11. Investment Company Act. None of the Acquisition Entities is an "investment company" or, a Person directly or indirectly controlled by or acting on behalf of an "investment company", in each case within the meanings of the Investment Company Act.

Section 7.12. Intended Tax Treatment. Except as contemplated by this Agreement and the Transactions, such Acquisition Entity has not taken any action or agreed to take any action, nor to the knowledge of such Acquisition Entity are there any facts or circumstances, that could reasonably be expected to prevent the Transactions from qualifying for the Intended Tax Treatment.

## ARTICLE VIII

### COVENANTS OF THE COMPANY & THE SELLERS

Section 8.1. Company Conduct of Business. From the date of this Agreement through the earlier of the Share Exchange Closing or valid termination of this Agreement pursuant to Article XII (the "Interim Period"), the Company shall, and shall cause its Subsidiaries to, except (i) as otherwise explicitly contemplated by this Agreement, the other Transaction Documents or the Permitted Activities Documents, (ii) as required by Law or (iii) as consented to by Acquiror in writing (which consent shall not be unreasonably conditioned, withheld, delayed or denied), (A) use reasonable best efforts to operate its business in the ordinary course consistent with past practice; and (B) comply with its Governing Documents, except solely in the case of any Subsidiary of the Company, where non-compliance by such Subsidiary would not be material to the business of the Company and its Subsidiaries taken as a whole. Without limiting the generality of the foregoing, except as set forth on Section 8.1 of the Company Disclosure Letter or as consented to by Acquiror in writing (which consent shall not be unreasonably conditioned, withheld, or delayed), the Company shall not, and the Company shall cause its Subsidiaries not to, except as otherwise contemplated by this Agreement, the Permitted Activities Documents or the other Transaction Documents or required by Law:

(a) change or amend the Governing Documents of the Company or any of the Company's Subsidiaries, except in the case of any of the Company's Subsidiaries only, for any such change or amendment made in the ordinary course of business and which is not material to the business of the Company and its Subsidiaries taken as a whole;

(b) make or declare any dividend or distribution to the shareholders of the Company or make any other distributions in respect of any Equity Securities of the Company;

(c) (i) split, combine, reclassify, recapitalize or otherwise amend any terms of any shares or series of the Company's or any of its Subsidiaries' Equity Securities, except for any such transaction by a Subsidiary of the Company that remains a Subsidiary of the Company after consummation of such transaction; or (ii) amend any term or alter any rights of any of its outstanding Equity Securities;

(d) purchase, repurchase, redeem or otherwise acquire any issued and outstanding share capital or outstanding Equity Securities of the Company or its Subsidiaries, except for (i) the acquisition by the Company or any of its Subsidiaries of any shares or Equity Securities of the Company or its Subsidiaries in connection with the forfeiture or cancellation of such interests in accordance with the terms of the applicable Contracts as in effect on the date hereof and (ii) transactions between the Company and any wholly-owned Subsidiary of the Company or between wholly-owned Subsidiaries of the Company;

(e) enter into, modify in any material respect or terminate (other than expiration in accordance with its terms) any Material Contract, other than (i) in the ordinary course of business consistent with past practice or as required by Law or (ii) in connection with the payment or discharge of obligations to creditors of the Company in furtherance of the consummation of the Share Exchange;

(f) sell, assign, transfer, convey, lease, exclusively license or otherwise dispose of any material tangible assets or properties of the Company or its Subsidiaries, except for (i) dispositions of obsolete or worthless equipment, (ii) transactions among the Company and its Subsidiaries or among its wholly-owned Subsidiaries and (iii) transactions in the ordinary course of business consistent with past practice;

(g) except (y) as otherwise required by Law or (z) pursuant to the Material Contracts, (i) grant any equity or equity based awards or other severance, retention, change in control or termination or similar pay, except in connection with the promotion, hiring or termination of employment of any employee in the ordinary course of business consistent with past practice, (ii) make any change in the key management structure of the Company, including the hiring of additional officers (other than such hiring in the ordinary course of business consistent with past practice) or the termination of existing officers, other than terminations for cause or due to death or disability, (iii) terminate, adopt, enter into or materially amend any Company Benefit Plan, or (iv) materially increase the cash compensation or bonus opportunity of any officer or director except in the ordinary course of business consistent with past practice and pursuant to existing Company Benefit Plans as in effect on the date hereof;

(h) (i) acquire (whether by merger, consolidation, amalgamation, scheme or similar transaction, purchase of securities of or otherwise) any corporation, partnership, association, joint venture or other business organization or division thereof, (ii) make any acquisition of, or investment in, a business, by purchase of stock, securities or assets, contributions to capital, or loans or advances, with a value or purchase price in excess of \$200,000 individually or \$200,000 in the aggregate, other than cash management by the Company or its Subsidiaries of the Company's Subsidiaries, (iii) enter into any closing agreement in respect of material Taxes or enter into any Tax sharing or similar agreement (other than any such agreement solely between the Company and its existing Subsidiaries, and customary commercial Contracts not primarily related to Taxes), or (iv) settle any claim or assessment in respect of material Taxes;

(i) issue or sell any debt securities or warrants or other rights to acquire any debt securities of the Company or any Subsidiary of the Company or otherwise incur, assume or guarantee or otherwise become liable for any Indebtedness, except (i) in a principal amount not exceeding \$200,000, (ii) borrowings under credit agreements disclosed in Section 8.1 of the Company Disclosure Letter, in the form that exists on the date hereof, or (iii) the ordinary course funding and cash management by the Company or its Subsidiaries of the Company's Subsidiaries;

(j) make or change any material election in respect of material Taxes, materially amend, modify or otherwise change any filed material Tax Return, adopt or request permission of any Tax authority to change any accounting method in respect of material Taxes, or consent to any extension or waiver of the limitation period applicable to any claim or assessment in respect of material Taxes or with respect to any material Tax attribute that would give rise to any claim or assessment of Taxes;

(k) take any action, or knowingly fail to take any action, where such action or failure to act could reasonably be expected to prevent the Transactions from qualifying for the Intended Tax Treatment;

(l) issue any additional Company Ordinary Shares, Equity Securities or securities exercisable for or convertible or exchangeable into Company Ordinary Shares or other Equity Securities of the Company;



(m) adopt a plan of, or otherwise enter into or effect a, complete or partial liquidation, dissolution, restructuring, recapitalization or other reorganization of the Company or its Subsidiaries;

(n) waive, release, settle, compromise or otherwise resolve any inquiry, investigation, claim, Action, litigation or other Legal Proceedings, except in the ordinary course of business or where such waivers, releases, settlements or compromises involve only the payment of monetary damages in an amount less than \$200,000 in the aggregate;

(o) grant to, or agree to grant to, any Person rights to any Intellectual Property or software that is material to the Company and its Subsidiaries, taken as a whole, or dispose of, abandon or permit to lapse any rights to any Intellectual Property that is material to the business of the Company and its Subsidiaries, taken as a whole, except for the expiration of Company Registered Intellectual Property in accordance with the applicable statutory term (or in the case of domain names, applicable registration period) or in the reasonable exercise of the Company's or any of its Subsidiaries' business judgment as to the costs and benefits of maintaining the item;

(p) make or commit to make capital expenditures other than in an amount not in excess of \$200,000 in the aggregate;

(q) manage the Company's and its Subsidiaries' working capital (including paying amounts payable in a timely manner when due and payable) in a manner other than in the ordinary course of business consistent with past practice;

(r) terminate without replacement, or fail to use reasonable efforts to maintain any License material to the conduct of the business of the Company and its Subsidiaries, taken as a whole;

(s) waive the restrictive covenant obligations of any current or former employee of the Company or any of the Company's Subsidiaries;

(t) (i) limit the right of the Company or any of the Company's Subsidiaries to engage in any line of business or in any geographic area, to develop, market or sell products or services, or to compete with any Person or (ii) grant any exclusive or similar rights to any Person, in each case, except where such limitation or grant does not, and would not be reasonably likely to, individually or in the aggregate, materially and adversely affect, or materially disrupt, the ordinary course operation of the businesses of the Company and its Subsidiaries, taken as a whole;

(u) terminate without replacement or amend in a manner materially adverse to the Company and its Subsidiaries, taken as a whole, any insurance policy insuring any risks of the business of the Company or any of the Company's Subsidiaries;

(v) make any material change in its accounting principles or methods unless required by FRSs or applicable Law or, to the extent applicable to the Company or a Subsidiary, applicable local accounting standards; or

(w) enter into any agreement to do any action prohibited under this [Section 8.1](#).

Section 8.2. Inspection. Subject to confidentiality obligations and similar restrictions that may be applicable to information furnished to the Company or any of the Company's Subsidiaries by third parties that may be in the Company's or any of its Subsidiaries' possession from time to time, and except for any information that is subject to attorney-client privilege, and to the extent permitted by applicable Law, the Company shall, and shall cause its Subsidiaries to, afford to Acquiror, PubCo, New SubCo and their respective Representatives reasonable access during the Interim Period, during normal business hours and with reasonable advance written notice, in such manner as to not materially interfere with the ordinary course of business of the Company and its Subsidiaries, to their respective properties, books, Contracts, Tax Returns, legal proceedings, commitments, records and appropriate officers and employees of the Company and its Subsidiaries, and shall furnish such representatives with financial and operating data and other information concerning the affairs of the Company and its Subsidiaries that are in the possession or control of the Company or its Subsidiaries as such representatives may reasonably request, for the purposes of and in connection with the Transactions. All information obtained by Acquiror, New SubCo, PubCo or their respective Representatives pursuant to this [Section 8.2](#) shall be subject to the confidentiality requirements under this Agreement.

Section 8.3. Preparation and Delivery of Additional Company Financial Statements.

(a) As soon as reasonably practicable following the date hereof, the Company shall deliver to Acquiror and PubCo (i) an audited consolidated statement of financial positions and consolidated statements of comprehensive income, changes in equity and cash flows of the Company and its Subsidiaries as of and for the years ended June 30, 2021 and June 30, 2022, together with the auditor's reports thereon, which comply in all material respects with the applicable accounting requirements (including the standards of the PCAOB) and with the rules and regulations of the SEC, the Exchange Act and the Securities Act applicable to a registrant (the "[PCAOB Financial Statements](#)").

(b) Upon delivery of the PCAOB Financial Statements, such financial statements shall (i) be deemed to be included in "Audited Financial Statements" for the purposes of this Agreement and the representations and warranties set forth in [Section 5.9](#) shall be deemed to apply to such Audited Financial Statements *mutatis mutandis* with the same force and effect as if the financial statements delivered in accordance with [Section 8.3](#) were delivered prior to the date of this Agreement.

(c) Each of the Company and the Acquiring Parties and shall each use its respective reasonable best efforts to (i) assist the other, upon advance written notice, during normal business hours and in a manner such as to not unreasonably interfere with the normal operation of the Company, any of its Subsidiaries, PubCo, Merger Sub, New SubCo or Acquiror, in preparing in a timely manner other financial information or statements (including customary pro forma financial statements) that are required to be included in the Proxy/Registration Statement and any other filings to be made by PubCo, Acquiror or the Company with the SEC in connection with the Transactions, and (ii) to obtain the consent of its auditors with respect thereto as may be required by applicable Law or requested by the SEC in connection therewith.

Section 8.4. Alternative Proposals. From the date hereof until the Share Exchange Closing Date or, if earlier, the termination of this Agreement in accordance with Article XII, the Company and its Subsidiaries shall not, and shall direct its controlled, controlling and common control Affiliates, and its and their respective Representatives not to, directly or indirectly, (a) solicit, initiate or pursue any inquiry, indication of interest, proposal or offer relating to an Alternative Proposal, (b) participate in or continue any discussions or negotiations with any third party with respect to, or furnish or make available, any information concerning the Company or any of its Subsidiaries to any third party relating to an Alternative Proposal or provide to any third-party access to the businesses, properties, assets or personnel of the Company or any of its Subsidiaries, in each case for the purpose of encouraging or facilitating an Alternative Proposal, or (c) enter into any binding understanding, binding arrangement, acquisition agreement, merger agreement or similar definitive agreement, or any letter of intent, memorandum of understanding or agreement in principle, or any other agreement with respect to an Alternative Proposal, or (d) grant any waiver, amendment or release under any confidentiality agreement or otherwise knowingly facilitate any such inquiries, proposals, discussions, or negotiations or any effort or attempt by any Person to make, an Alternative Proposal. From and after the date hereof, the Company shall, and shall instruct its officers and directors to, and the Company shall instruct and cause its Representatives, Subsidiaries and their respective Representatives to, immediately cease and terminate all discussions and negotiations with any Persons (other than Acquiror and its Representatives) with respect to an Alternative Proposal.

Section 8.5. Exchange Listing. From the date of this Agreement through the earlier of the Share Exchange Closing and termination of this Agreement, the Company shall provide all reasonable assistance reasonably required by PubCo in order for PubCo to cause the PubCo Securities to be issued in connection with the Transactions to be approved for listing on Nasdaq and accepted for clearance by the DTC, subject to official notice of issuance, prior to the Share Exchange Closing Date.

Section 8.6. Notice of Developments. From and after the date of this Agreement until the earlier of the Share Exchange Closing or the termination of this Agreement in accordance with its terms, the Company shall promptly (and in any event prior to the Share Exchange Closing) notify Acquiror in writing, upon the Company or any of its Subsidiaries becoming aware (awareness being determined with reference to the knowledge of the Company) of: (a) the occurrence or non-occurrence of any event the occurrence or non-occurrence of which has caused or is reasonably likely to cause any condition to the obligations of the Company to effect the Transactions not to be satisfied, (b) any breach of a representation or warranty given by the Company in this Agreement, or (c) any notice or other communication from any Governmental Authority which is reasonably likely, individually or in the aggregate, to have a material adverse effect on the ability of the parties hereto to consummate the Transactions or to materially delay the timing thereof. The delivery of any notice pursuant to this Section 8.6 shall not cure any breach of any representation or warranty made by the Company as of the date of this Agreement but shall supplement the disclosure letter delivered by the Company on the date hereof and qualify the representations and warranties given by the Company in Article V.

Section 8.7. No Trading. The Company and each Seller acknowledges and agrees that it is aware, and that its Affiliates have been made aware of the restrictions imposed by U.S. federal securities laws and the rules and regulations of the SEC promulgated thereunder or otherwise and other applicable foreign and domestic Laws on a Person possessing material nonpublic information about a publicly traded company. The Company and each Seller hereby agrees that while it is in possession of such material nonpublic information, it shall not and shall cause its Subsidiaries not to purchase or sell any securities of Acquiror in violation of such Laws.

Section 8.8. Support of Share Exchange. Sellers shall exercise their rights as the shareholder of the Company in so far as it is able to consummate and procure the consummation of the Share Exchange and the Company shall use its best effort to cause and support the Sellers to consummate and procure the consummation of the Share Exchange.

## ARTICLE IX

### COVENANTS OF ACQUIROR PARTIES

Section 9.1. Trust Account Proceeds. Upon satisfaction or waiver of the conditions set forth in Article XI and provision of notice thereof to the Trustee (which notice Acquiror shall be provided to the Trustee in accordance with the terms of the Trust Agreement), (a) in accordance with and pursuant to the Trust Agreement, at the Share Exchange Closing, Acquiror (i) shall cause any documents, opinions and notices required to be delivered to the Trustee pursuant to the Trust Agreement to be so delivered and (ii) shall use its reasonable best efforts to cause the Trustee to, and the Trustee shall thereupon be obligated to (A) pay as and when due all amounts payable to Acquiror Shareholders pursuant to the Acquiror Share Redemptions, (B) pay the amounts due to the underwriters of Acquiror's initial public offering for their deferred underwriting commission as set forth in the Trust Agreement, (C) pay any accrued and unpaid Acquiror Transaction Expenses and Company Transaction Expenses in accordance with Section 3.5 to the extent not previously paid, and (D) pay all remaining amounts then available in the Trust Account to Acquiror in accordance with the Trust Agreement, and (b) thereafter, the Trust Account shall terminate, except as otherwise expressly provided in the Trust Agreement.

Section 9.2. Nasdaq Listing. From the date of this Agreement through the closing of the Merger, (a) Acquiror shall use its reasonable best efforts to ensure Acquiror remains listed as a public company on Nasdaq, and (b) PubCo shall apply for, and shall use reasonable best efforts to cause, the PubCo Ordinary Shares to be issued in connection with the Transactions to be approved for listing on the Nasdaq and accepted for clearance by the DTC, subject to official notice of issuance, on or prior to the Share Exchange Closing Date. After the date hereof and prior to the Share Exchange Closing, Acquiror Parties shall procure the reservation of the ticker symbol on Nasdaq that is mutually agreed to by the Company and Acquiror.

Section 9.3. No Solicitation. From the date hereof until the Share Exchange Closing Date or, if earlier, the termination of this Agreement in accordance with Article XII, each Acquiror Party shall not, and shall direct any of the Sponsor and its controlled Affiliates and its and their respective officers, directors and Representatives not to, directly or indirectly (a) solicit, initiate, or pursue any inquiry, indication of interest, proposal or offer relating to an Acquiror Acquisition Proposal, (b) participate in or continue any discussions or negotiations with any third-party with respect to, or furnish or make available, any information concerning Acquiror to any third party relating to an Acquiror Acquisition Proposal, or provide to any third-party access to the businesses, properties, assets or personnel of Acquiror, in each case for the purpose of encouraging or facilitating an Acquiror Acquisition Proposal or (c) enter into any binding understanding, binding arrangement, acquisition agreement, merger agreement or similar definitive agreement, or any letter of intent, memorandum of understanding or agreement in principle, or any other agreement with respect to an Acquiror Acquisition Proposal, or (d) grant any waiver, amendment or release under any confidentiality agreement or otherwise knowingly facilitate any such inquiries, proposals, discussions, or negotiations or any effort or attempt by any Person to make, an Acquiror Acquisition Proposal. From and after the date hereof, each Acquiror Party shall, and shall direct any of the Sponsors and its controlled Affiliates and its and their respective officers, directors and Representatives to, immediately cease and terminate all discussions and negotiations with any Persons (other than the Company and its Representatives) with respect to an Acquiror Acquisition Proposal.

Section 9.4. Conduct of Business. During the Interim Period, each Acquiror Party shall, except (i) as otherwise explicitly contemplated by this Agreement or the other Transaction Documents or its Governing Documents, (ii) as required by Law, or (iii) as consented to by the Company in writing (which consent shall not be unreasonably conditioned, withheld, or delayed), (A) use reasonable best efforts to operate its business in the ordinary course consistent with past practice; and (B) comply in all material respects with its Governing Documents. Without limiting the generality of the foregoing, except as consented to by the Company in writing (which consent shall not be unreasonably conditioned, withheld or delayed) Acquiror shall not, and PubCo shall cause its Subsidiaries not to, except as otherwise contemplated by this Agreement or the other Transaction Documents or as required by Law:

(a) change, modify or amend the Trust Agreement (in the case of Acquiror only) or its Governing Documents, or seek any approval from its shareholders to do so, except as contemplated by the Transaction Proposals;

(b) merge, consolidate or amalgamate with or into, or acquire (by purchasing a substantial portion of the assets of or equity in, or by any other manner) any other Person or be acquired by any other Person;

(c) (x) make or declare any dividend or distribution to its shareholders or make any other distributions in respect of any of its Equity Securities, (y) split, combine, reclassify or otherwise amend any terms of its Equity Securities, or (z) purchase, repurchase, redeem or otherwise acquire any of its issued and outstanding Equity Securities, other than, in the case of Acquiror only, redemptions of Acquiror Common Stock made as part of the Acquiror Share Redemptions;

(d) except in the ordinary course of business consistent with past practice, (A) make or change any material election in respect of material Taxes, (B) materially amend, modify or otherwise change any filed material Tax Return, (C) adopt or request permission of any Tax authority to change any accounting method in respect of material Taxes, (D) enter into any closing agreement in respect of material Taxes or enter into any Tax sharing or similar agreement (other than customary commercial Contracts not primarily related to Taxes), (E) settle any claim or assessment in respect of material Taxes, or (F) consent to any extension or waiver of the limitation period applicable to any claim or assessment in respect of material Taxes or with respect to any material Tax attribute that would give rise to any claim or assessment of Taxes;

(e) except as contemplated by this Agreement or the Transactions, take any action, or knowingly fail to take any action, where such action or failure to act could reasonably be expected to prevent the Transactions from qualifying for the Intended Tax Treatment;

(f) other than as expressly required by any Transaction Document, enter into, renew or amend in any material respect, any Contract with any of the Sponsors or an Affiliate of Acquiror Party (including (i) any Person in which any of the Sponsors has a direct or indirect legal or beneficial ownership interest of five percent (5%) or greater and (ii) any Person who has a direct or indirect legal or beneficial ownership interest of five percent (5%) or greater in any of the Sponsors);

(g) incur, guarantee or otherwise become liable for any Indebtedness, other than (i) liabilities incurred in the ordinary course of business and in an amount, individually or in the aggregate, not to exceed \$100,000 and (ii) any Acquiror Transaction Expenses;

(h) other than, in the case of Acquiror only, (1) issuances of new Acquiror convertible notes to Sponsors or their designees/affiliates in respect of the capitalization of any Working Capital Loans in the aggregate amount of no more than \$3,000,000 or (2) issuance of Equity Securities of Acquiror in connection with the Transaction Financing in accordance with the Transaction Financing Agreements, and in the case of PubCo only, issuance of new PubCo securities in connection with the Transaction Financing in accordance with the Transaction Financing Agreements, (A) issue any Equity Securities or securities exercisable for or convertible into Equity Securities, (B) grant any options, warrants or other equity-based awards with respect to any Equity Securities not outstanding on the date hereof, or (C) other than pursuant to the Transaction Documents, amend, modify or waive any of the terms or rights set forth in any Acquiror Warrant or the Warrant Agreement, including any amendment, modification or reduction of the warrant price set forth therein;

(i) make any change in its accounting principles or methods unless required by GAAP;

(j) form any Subsidiary or commence any new line of business;

(k) liquidate, dissolve, reorganize or otherwise wind-up its business and operations;

(l) amend, wave or assign any material right under any material Contract to which it is a party; waive, release, assign, settle or compromise any claim, action or proceeding (including any suit, action, claim, proceeding or investigation relating to this Agreement or the transactions contemplated hereby), other than waivers, releases, assignments, settlements or compromises that involve only the payment of monetary damages (and not the imposition of equitable relief on, or the admission of wrongdoing by, Acquiror or its Subsidiary) not in excess of \$1,000,000 (individually or in the aggregate), or otherwise pay, discharge or satisfy any Actions, Liabilities or obligations, in each case due and payable only before the Share Exchange Closing; or

(m) enter into any agreement to do any action prohibited under this Section 9.4.

Section 9.5. Public Filings. From the date hereof through the Share Exchange Closing, Acquiror Parties shall keep current and timely file all reports required to be filed or furnished with the SEC and otherwise comply in all material respects with its reporting obligations under applicable Laws.

Section 9.6. Shareholder Litigation. Without limiting Section 9.4 above, in the event that any litigation related to this Agreement, any other Transaction Document or the transactions contemplated hereby or thereby is brought, or, to the knowledge of Acquiror, threatened in writing, against any Acquiror Party or the board of directors of any Acquiror Party by any Acquiror Shareholders prior to the Share Exchange Closing, such Acquiror Party shall promptly after becoming aware of such litigation notify the Company of any such litigation and keep the Company reasonably informed with respect to the status thereof. Acquiror Parties shall provide the Company the opportunity to participate in (at its own cost and subject to a customary joint defense agreement), but not control, the defense of any such litigation, and shall consider in good faith the Company's suggestions with respect to such litigation and shall not settle any such litigation without the prior written consent of the Company, such consent not to be unreasonably withheld, conditioned, delayed or denied.

Section 9.7. Section 16 Matters. Prior to the Share Exchange Closing Date, Acquiror Parties shall take all such steps (to the extent permitted under applicable Law) as are reasonably necessary to cause any acquisition or disposition of PubCo Securities or any derivative thereof that occurs or is deemed to occur by reason of or pursuant to the Transactions by each Person who is or will be or may become subject to Section 16 of the Exchange Act with respect to PubCo, including by virtue of being deemed a director by deputization, to be exempt under Rule 16b-3 promulgated under the Exchange Act.

Section 9.8. PubCo Equity Plan. On the Merger Closing, PubCo shall have adopted an equity incentive plan substantially in the form attached hereto as Exhibit E prior to the Merger Closing ("PubCo ESOP").

Section 9.9. PubCo Charter. Acquiror and Acquisition Entities shall take all such action to procure that at the Merger Closing, PubCo's Governing Documents, as in effect immediately prior to the Share Exchange Closing, shall have read in their entirety in the form of the amended and restated memorandum and articles of association of PubCo substantially in the form attached hereto as Exhibit F (the "Post-Combination PubCo Charter"), and, as so amended and restated, the Post-Combination PubCo Charter shall be the memorandum and articles of association of PubCo, until thereafter amended in accordance with the terms thereof and the Cayman Companies Act. At the Merger Closing, the new name of PubCo will be "noco-noco Inc." or such other name as provided to the PubCo by the Company and stated in the Post-Combination PubCo Charter.

Section 9.10. Support of Share Exchange. PubCo shall exercise its rights as the sole shareholder of New SubCo in so far as it is able to cause and support New SubCo to consummate and procure the consummation of the Share Exchange. Acquiror shall use best efforts to procure the extension of its term prior to May 16, 2023 in accordance with Acquiror's Governing Documents if the Merger Closing is not reasonably expected to occur prior to May 16, 2023.

Section 9.11. Notice of Development. From and after the date of this Agreement until the earlier of the Share Exchange Closing or the termination of this Agreement in accordance with its terms, the Acquiror shall promptly (and in any event prior to the Share Exchange Closing) notify Acquiror in writing, upon any Acquiror Party becoming aware (awareness being determined with reference to the knowledge of the Acquiror) of: (a) the occurrence or non-occurrence of any event the occurrence or non-occurrence of which has caused or is reasonably likely to cause any condition to the obligations of any Acquiror Party to effect the Transactions not to be satisfied, (b) any breach of a representation or warranty given by Acquiror in this Agreement or Acquisition Entity in this Agreement or (c) any notice or other communication from any Governmental Authority which is reasonably likely, individually or in the aggregate, to have a material adverse effect on the ability of the parties hereto to consummate the Transactions or to materially delay the timing thereof. The delivery of any notice pursuant to this Section 9.11 shall not cure any breach of any representation or warranty made by the Acquiror Parties but shall supplement the disclosure letter delivered by the Acquiror on the date hereof and qualify the representations and warranties given by the Acquiror Parties in this Agreement.



Section 9.12. Transaction Financing Efforts. Acquiror Parties shall have used reasonable best efforts to obtain equity financing (the “Transaction Financing”) on the terms mutually agreed to by the Company and Acquiror, in an amount that is at least \$20,000,000 prior to or upon the Share Exchange Closing.

## ARTICLE X

### JOINT COVENANTS

#### Section 10.1. Regulatory Approvals; Other Filings.

(a) Each of the Company and the Acquiror Parties shall use its respective commercially reasonable efforts to cooperate in good faith with any Governmental Authority and use its commercially reasonable efforts to undertake promptly any and all action required to obtain any necessary regulatory approvals, consents, Actions, nonactions or waivers in connection with the Transactions (the “Regulatory Approvals”) as soon as reasonably practicable and any and all action necessary to consummate the Transactions as contemplated hereby. Each of the Company and the Acquiror Parties shall use its respective commercially reasonable efforts to cause the expiration or termination of the waiting, notice or review periods under any applicable Regulatory Approval with respect to the Transactions as promptly as reasonably possible after the execution of this Agreement.

(b) With respect to each of the above filings, and any other requests, inquiries, Actions or other proceedings by or from Governmental Authorities, each of the Company and Acquiror shall (and, to the extent required, shall cause its controlled Affiliates to) (i) diligently and expeditiously defend and use reasonable best efforts to obtain any necessary clearance, approval, consent, or Governmental Authorization under Laws prescribed or enforceable by any Governmental Authority for the transactions contemplated by this Agreement and to resolve any objections as may be asserted by any Governmental Authority with respect to the transactions contemplated by this Agreement; and (ii) cooperate in good faith with each other in the defense of such matters. To the extent not prohibited by Law, the Company, on the one hand, and Acquiror Parties, on the other, shall (and shall cause its Subsidiaries to) promptly furnish to Acquiror, and Acquiror shall promptly furnish to the Company, copies of any notices or written communications received by such party or any of its Affiliates from any third party or any Governmental Authority with respect to the transactions contemplated hereby, and each party shall permit counsel to the other parties an opportunity to review in advance, and each party shall consider in good faith the views of such counsel in connection with, any proposed written communications by such party and/or its Affiliates to any Governmental Authority concerning the transactions contemplated hereby; provided, that none of the parties shall extend any waiting period or comparable period or enter into any agreement with any Governmental Authority without the written consent of the other parties. To the extent not prohibited by Law, the Company agrees to provide Acquiror and its counsel, and Acquiror agrees to provide the Company and its counsel, the opportunity, on reasonable advance notice, to participate in any substantive meetings or discussions, either in person or by telephone, between such party and/or any of its Affiliates, agents or advisors, on the one hand, and any Governmental Authority, on the other hand, concerning or in connection with the transactions contemplated hereby.

(c) Subject to Section 13.6, the Company, on the one hand, and Acquiror Parties, on the other, shall each be responsible for and pay one-half of the cost for the preparation, filing and other related fees in connection with the Regulatory Approvals.

Section 10.2. Proxy/Registration Statement.

(a) Proxy/Registration Statement and Prospectus.

(i) As promptly as reasonably practicable after the execution of this Agreement, the Company and the Acquiror Parties shall prepare, and PubCo shall file with the SEC, a registration statement on Form F-4 (as amended or supplemented from time to time, and including a proxy statement, the "Proxy/Registration Statement") among other things, registering the PubCo Securities issuable to the holders of Acquiror Securities prior to the Merger Effective Time and the holders of Company Ordinary Shares pursuant to this Agreement, and relating to the Acquiror Shareholders' Meeting to approve and adopt: (A) the Merger and the Certificate of Merger, (B) this Agreement, the other Transaction Documents, and the Business Combination, (C) the adjournment of the Acquiror Shareholders' Meeting, if necessary, to permit further solicitation of proxies because there are not sufficient votes to approve and adopt any of the foregoing or any proposal in (D), and (D) any other proposals as the SEC (or staff member thereof) may indicate are necessary in its comments to the Proxy/Registration Statement or correspondence related thereto and any other proposals as reasonably agreed by Acquiror and the Company to be necessary or appropriate in connection with the transactions contemplated hereby (such proposals in (A) through (D), collectively, the "Transaction Proposals").

(ii) Acquiror Parties and the Company shall (and the Company shall cause each of its Subsidiaries to) each use its commercially reasonable efforts to (1) cause the Proxy/Registration Statement when filed with the SEC to comply in all material respects with all Laws applicable thereto and rules and regulations promulgated by the SEC, (2) respond as promptly as reasonably practicable to and resolve all comments received from the SEC concerning the Proxy/Registration Statement, (3) cause the Proxy/Registration Statement to be declared effective under the Securities Act as promptly as practicable and (4) keep the Proxy/Registration Statement effective as long as is necessary to consummate the Transactions. Prior to the effective date of the Proxy/Registration Statement, the Company, PubCo, Acquiror and New SubCo shall (and the Company shall cause each of its Subsidiaries to) use its commercially reasonable efforts to take all or any action required under any applicable federal or state securities Laws in connection with the issuance of PubCo Securities pursuant to this Agreement. Each of the Company, PubCo, Acquiror and New Sub also agrees to (and shall cause each of its Subsidiaries to) use its commercially reasonable efforts to obtain all necessary state securities law or "Blue Sky" permits and approvals required to carry out the Transactions, and the Company shall furnish all information concerning the Company and its Subsidiaries and any of their respective members or shareholders as may be reasonably requested in connection with any such action.

(iii) Each of Acquiror Parties and the Company shall furnish to the other parties all information concerning itself, its Subsidiaries, officers, directors, managers, shareholders, and other equityholders and information regarding such other matters as may be reasonably necessary or advisable or as may be reasonably requested in connection with the Proxy/Registration Statement, or any other statement, filing, notice or application made by or on behalf of Acquiror Parties, the Company or their respective Affiliates to any regulatory authority (including the Nasdaq) in connection with the Transactions.

(iv) Subject to Section 13.6, the Company, on the one hand, and Acquiror, on the other, shall each be responsible for and pay one-half of the cost for the preparation, filing and mailing of the Proxy/Registration Statement and other related fees including tax filing related matters arising from the preparation, filing and other related fees and necessary legal opinion that may be requested by the SEC in connection with the Intended Tax Treatment, provided that any fees and expenses arising from the legal and/or tax opinion prepared for analyzing the tax treatment of the Merger shall be borne by the Acquiror Parties. The Company shall be responsible for reasonable costs actually incurred for the establishment of PubCo and New SubCo and other related organization and maintenance expenses arising with respect to PubCo and New SubCo.

(v) Any filing of, or amendment or supplement to, the Proxy/Registration Statement will be mutually prepared and agreed upon by Acquiror Parties and the Company. PubCo will advise the Company and Acquiror, promptly after receiving notice thereof, of the time when the Proxy/Registration Statement has become effective or any supplement or amendment has been filed, of the issuance of any stop order, of the suspension of the qualification of any PubCo Securities to be issued or issuable in connection with this Agreement for offering or sale in any jurisdiction, or of any request by the SEC for amendment of the Proxy/Registration Statement or comments thereon and responses thereto or requests by the SEC for additional information and responses thereto, and shall provide the Company or Acquiror (as applicable) a reasonable opportunity to provide comments and amendments to any such filing. Acquiror Parties and the Company shall cooperate and mutually agree upon (such agreement not to be unreasonably withheld or delayed) any response to comments of the SEC or its staff with respect to the Proxy/Registration Statement and any amendment to the Proxy/Registration Statement filed in response thereto.

(vi) Each of Acquiror Parties and the Company shall ensure that none of the information supplied by it or on its behalf for inclusion or incorporation by reference in (A) the Proxy/Registration Statement will, at the time the Proxy/Registration Statement is filed with the SEC, at each time at which it is amended and at the time it becomes effective under the Securities Act, contain any untrue statement of a material fact or omit to state any material fact required to be stated therein or necessary to make the statements therein not misleading or (B) the Proxy/Registration Statement will, at the date it is first mailed to the Acquiror Shareholders and at the time of the Acquiror Shareholders' Meeting, contain any untrue statement of a material fact or omit to state any material fact required to be stated therein or necessary in order to make the statements therein, in light of the circumstances under which they are made, not misleading.

(vii) If at any time prior to the Share Exchange Closing the Company or any Acquiror Party becomes aware that any information relating to the Company, any Acquiror Party or any of their respective Subsidiaries, Affiliates, directors or officers set forth in the Proxy/ Registration Statement is required to be amended, so that the Proxy/Registration Statement would not include any untrue statement of a material fact or omit to state any material fact necessary to make the statements therein not misleading, the party which discovers such information shall promptly notify the other parties and an appropriate amendment or supplement describing and/or correcting such information shall be promptly filed with the SEC and, to the extent required by Law, disseminated to the Acquiror Shareholders and Company Shareholders.

(b) Acquiror Shareholder Approval.

(i) After the Proxy/Registration Statement is declared effective under the Securities Act, Acquiror shall (A) within ten (10) Business Days thereof, mail the Proxy/Registration Statement to the Acquiror Shareholders (which shall set forth a record date for, duly call and give notice of a meeting of the Acquiror Shareholders (including any adjournment or postponement thereof, the "Acquiror Shareholders' Meeting") and (B) no later than thirty (30) Business Days after the mailing of the Proxy/Registration Statement to the Acquiror Shareholders, or such other date as may be agreed by Acquiror and the Company, acting reasonably, hold such Acquiror Shareholders' Meeting for the purpose of voting on the Transaction Proposals, obtaining the Acquiror Shareholders' Approval (including if necessary any adjournment or postponement of such meeting for the purpose of soliciting additional proxies in favor of the adoption of this Agreement), and providing Acquiror Shareholders with the opportunity to elect to effect an Acquiror Share Redemption and such other matters as may be mutually agreed by Acquiror and the Company.

(ii) Acquiror will use its reasonable best efforts to (A) solicit from its shareholders proxies in favor of the adoption of the Transaction Proposals, including the Acquiror Shareholders' Approval, and (B) obtain the vote or consent of its shareholders required by and in compliance with all applicable Law, Nasdaq rules and the Acquiror's Governing Documents. Acquiror (A) shall consult with the Company regarding the record date and the date of the Acquiror Shareholders' Meeting, and (B) shall not adjourn or postpone the Acquiror Shareholders' Meeting more than twice (and in that event, for no more than thirty (30) days in the aggregate) without the prior written consent of Company (which consent shall not be unreasonably withheld, conditioned or delayed); provided, that Acquiror shall not be required to adjourn or propose to adjourn the Acquiror Shareholders' Meeting.

(iii) The Proxy/Registration Statement shall include a statement to the effect that the board of directors of Acquiror (the "Acquiror Board") has unanimously recommended that the Acquiror Shareholders vote in favor of the Transaction Proposals at the Acquiror Shareholders' Meeting (such statement, the "Acquiror Board Recommendation") and neither the Acquiror Board nor any committee thereof shall withhold, withdraw, qualify, amend or modify, or publicly propose or resolve to withhold, withdraw, qualify, amend or modify, the Acquiror Board Recommendation.

(c) Company Shareholder Approval.

(i) As promptly as reasonably practicable after the Proxy/Registration Statement is declared effective under the Securities Act, and on a date no later than twenty (20) Business Days following such effectiveness, the Company shall (A) solicit and obtain the Company Shareholder Approval by way of passing a resolution of the Company Shareholders by written means in accordance with the Singapore Companies Act (the "Company Shareholders' Written Resolution"), or (B) in the event the Company is not able to obtain the Company Shareholders' Written Resolution, establish a record date for, duly call, give notice of, convene and hold a meeting of the Company Shareholders (including any adjournment thereof, the "Company Shareholders' Meeting") to be held as promptly as reasonably practicable following the date that the Proxy/Registration Statement is declared effective under the Securities Act, and on a date no later than twenty (20) Business Days following such effectiveness, for the purpose of obtaining the Company Shareholder Approval (including any adjournment of such meeting for the purpose of soliciting additional proxies in favor of this Agreement) and such other matter as may be mutually agreed by Acquiror and the Company. The Company will use its reasonable best efforts to (A) solicit from its shareholders written consents and/or proxies in favor of the Company Shareholder Approval and (B) obtain the Company Shareholder Approval in compliance with all applicable Law and the Company's Governing Documents (including if necessary any adjournment or postponement of such meeting for the purpose of establishing a quorum). The Company (y) shall set the date of the Company Shareholders' Meeting to be no later than twenty (20) Business Days after the Proxy/Registration Statement is declared effective or such other date as may be agreed by Acquiror and the Company, acting reasonably, and (z) shall not adjourn the Company Shareholders' Meeting without the prior written consent of Acquiror (which consent shall not be unreasonably withheld, conditioned or delayed); provided, however, that the Company may adjourn the Company Shareholders' Meeting for a period not exceeding sixteen (16) days without the consent of the Acquiror.

(ii) The Company shall send the Proxy/Registration Statement and the meeting materials to the Company Shareholders which shall seek the Company Shareholder Approval and shall include together with all such meeting materials it sends to the Company Shareholders in connection with the Company Shareholders' Meeting a statement to the effect that the board of directors of the Company (the "Company Board") has unanimously recommended that the Company Shareholders vote in favor of the Company Shareholder Approval (such statement, the "Company Board Recommendation") and neither the Company Board nor any committee thereof shall withhold, withdraw, qualify, amend or modify, or publicly propose or resolve to withhold, withdraw, qualify, amend or modify, the Company Board Recommendation.

Section 10.3. Support of Transaction. Without limiting any covenant contained in Article VIII or Article IX, each Party shall each, (a) use reasonable best efforts to obtain all material consents and approvals of third parties that such Party is required to obtain in order to consummate the Merger and the Share Exchange, and (b) take such other action as may be reasonably necessary or as another Party hereto may reasonably request to satisfy the conditions of Article XI or otherwise to comply with this Agreement and to consummate the transactions contemplated hereby as soon as practicable; provided that the Company shall not be required to act or omit to take any action that would constitute a breach of Section 8.1 and Acquiror Parties shall not be required to act or omit to take any action that would constitute a breach of Section 9.4.

Section 10.4. Public Announcements.

(a) The Parties agree that, at any time on or after the date hereof and continuing until the earlier of the termination of this Agreement in accordance with Section 12.1 or the Share Exchange Closing, no public release, filing or announcement concerning this Agreement or the other Transaction Documents or the transactions contemplated hereby or thereby shall be issued by any party hereto or any of their Representatives or Affiliates without the prior written consent (not be unreasonably withheld, conditioned or delayed) of Acquiror and the Company, except as such release or announcement may be required by applicable Law or the rules or regulations of any securities exchange, in which case the applicable party hereto shall use commercially reasonable efforts to allow the other Parties reasonable time to comment on, and arrange for any required filing with respect to, such release or announcement in advance of such issuance

(b) The Parties shall mutually agree upon and, as promptly as practicable after the execution of this Agreement (but in any event within four (4) Business Days thereafter), issue a press release announcing the execution of this Agreement (the “Signing Press Release”). Promptly after the issuance of the Signing Press Release, Acquiror shall file a current report on Form 8-K (the “Signing Filing”) with the Signing Press Release and a description of this Agreement as required by applicable securities Laws, which shall be subject to the Company’s review, comment and approval prior to filing. The Parties shall mutually agree upon and, as promptly as practicable after the Combination (but in any event within four (4) Business Days thereafter), issue a press release announcing the consummation of the transactions contemplated by this Agreement (the “Closing Press Release”). Promptly after the issuance of the Closing Press Release, PubCo shall file a current report on Form 8-K (the “Closing Filing”) with the Closing Press Release and a description of the Closing as required by all applicable Laws which both of Acquiror and Company shall review, comment upon and approve (which approval shall not be unreasonably withheld, conditioned or delayed) prior to filing. In connection with the preparation of the Signing Press Release, the Signing Filing, the Closing Filing, the Closing Press Release, or any other report, statement, filing notice or application made by or on behalf of a party hereto to any Governmental Authority or other third party in connection with the transactions contemplated hereby, each of the Company on one hand, and the Acquiror Parties on the other, shall, upon request by the other, furnish the other parties with all information concerning themselves, their respective directors, officers and equity holders, and such other matters as may be reasonably necessary or advisable in connection with the transactions contemplated hereby, or any other report, statement, filing, notice or application made by or on behalf of a party hereto to any third party and/ or any Governmental Authority in connection with the transactions contemplated hereby.

#### Section 10.5. Confidential Information

(a) The Company, PubCo, New SubCo, Merger Sub and the Sellers agree that during the Interim Period and, in the event this Agreement is terminated in accordance with Article XII, for a period of two (2) years after such termination, they shall, and shall cause their respective Representatives to: (i) treat and hold in strict confidence any Acquiror Confidential Information, and will not use for any purpose (except in connection with the consummation of the transactions contemplated by this Agreement or the other Transaction Documents, performing their obligations hereunder or thereunder or enforcing their rights hereunder or thereunder), nor directly or indirectly disclose, distribute, publish, disseminate or otherwise make available to any third party any of the Acquiror Confidential Information without Acquiror’s prior written consent; and (ii) in the event that the Company, PubCo, New SubCo, Merger Sub, any Seller or any of their respective Representatives, during the Interim Period or, in the event that this Agreement is terminated in accordance with Article XII, for a period of two (2) years after such termination, becomes legally compelled to disclose any Acquiror Confidential Information, (A) provide Acquiror to the extent legally permitted with prompt written notice of such requirement so that Acquiror or an Affiliate thereof may seek, at Acquiror’s cost, a protective Order or other remedy or waive compliance with this Section 10.5(a), and (B) in the event that such protective Order or other remedy is not obtained, or Acquiror (including on behalf of any Acquiror Party) waives compliance with this Section 10.5(a), furnish only that portion of such Acquiror Confidential Information which is legally required to be provided as advised by outside counsel and to exercise its commercially reasonable efforts to obtain assurances that confidential treatment will be accorded such Acquiror Confidential Information. In the event that this Agreement is terminated and the transactions contemplated hereby are not consummated, the Company, PubCo, New SubCo, Merger Sub and the Sellers shall, and shall cause their respective Representatives to, promptly destroy any and all copies (in whatever form or medium) of Acquiror Confidential Information and destroy all notes, memoranda, summaries, analyses, compilations and other writings related thereto or based thereon. Notwithstanding the foregoing, the Company and each Signing Seller shall be permitted to disclose Acquiror Confidential Information to any prospective Joining Seller and in connection with any activities contemplated under Section 10.8(a).

(b) Each Acquiror Party hereby agrees that during the Interim Period and, in the event that this Agreement is terminated in accordance with Article XII, for a period of two (2) years after such termination, it shall, and shall cause its Representatives to: (i) treat and hold in strict confidence any Company Confidential Information, and will not use for any purpose (except in connection with the consummation of the transactions contemplated by this Agreement or the other Transaction Documents, performing its obligations hereunder or thereunder or enforcing its rights hereunder or thereunder), nor directly or indirectly disclose, distribute, publish, disseminate or otherwise make available to any third party any of the Company Confidential Information without the Company's prior written consent; and (ii) in the event that Acquiror or any of its Representatives, during the Interim Period or, in the event that this Agreement is terminated in accordance with Article XII, for a period of two (2) years after such termination, becomes legally compelled to disclose any Company Confidential Information, (A) provide the Company to the extent legally permitted with prompt written notice of such requirement so that the Company may seek a protective order or other remedy or waive compliance with this Section 10.5(b) and (B) in the event that such protective order or other remedy is not obtained, or the Company waives compliance with this Section 10.5(b), furnish only that portion of such Company Confidential Information which is legally required to be provided as advised by outside counsel and to exercise its commercially reasonable efforts to obtain assurances that confidential treatment will be accorded such Company Confidential Information. In the event that this Agreement is terminated and the transactions contemplated hereby are not consummated, each Acquiror Party shall, and shall cause its Representatives to, promptly destroy any and all copies (in whatever form or medium) of Company Confidential Information and destroy all notes, memoranda, summaries, analyses, compilations and other writings related thereto or based thereon.

Section 10.6. Transfer Taxes. All transfer, documentary, sales, use, real property, stamp, registration and other similar Taxes, fees and costs (including any associated penalties and interest) ("Transfer Taxes") incurred in connection with this Agreement or the other Transaction Documents by the Company and any Seller shall constitute Company Transaction Expenses.



Section 10.7. Tax Free Reorganization Matters. For U.S. federal income tax purposes (and for purposes of any applicable state or local Tax that follows the U.S. federal income tax treatment), the parties shall prepare and file all Tax Returns consistent with the Intended Tax Treatment, and to the extent required to do so and except to the extent prohibited by applicable Law, shall not take any inconsistent position on any Tax Return, or during the course of any audit, litigation or other proceeding with respect to Taxes, except as otherwise required by a determination within the meaning of Section 1313(a) of the Code. Without limiting the foregoing, PubCo shall ensure that an election is made under Treasury Regulation Section 301.7701-3(c), effective prior to the Merger Closing Date, to treat New SubCo as an entity disregarded from PubCo for U.S. federal income tax purposes.

Section 10.8. Cooperation; Consultation.

(a) Prior to the Share Exchange Closing, each of the Company on the one hand and the Acquiror Parties on the other, shall, and each of them shall cause its respective Representatives to, reasonably cooperate in a timely manner in connection with any financing arrangement (including the Transaction Financing) the parties mutually agree to seek in connection with the transactions contemplated by this Agreement (it being understood and agreed that the consummation of any such financing by the Company and the Acquiror Parties shall be subject to the Company's and the Acquiror Parties' mutual agreement), including (if mutually agreed by the Company and the Acquiror Parties) (i) by providing such information and assistance as the other party may reasonably request, (ii) granting such access to the other party and its Representatives as may be reasonably necessary for their due diligence, and (iii) participating in a reasonable number of meetings, presentations, road shows, drafting sessions and due diligence sessions with respect to such financing efforts (including direct contact between senior management and other Representatives of the Company and its Subsidiaries at reasonable times and locations). All such cooperation, assistance and access shall be granted during normal business hours and shall be granted under conditions that shall not unreasonably interfere with the business and operations of the Company, Acquiror, or their respective auditors.

(b) From the date hereof until the Share Exchange Closing, except to the extent inconsistent with applicable Laws or any confidentiality obligations to third parties, each of Acquiror and the Company shall keep the other reasonably informed from time to time upon reasonable request with respect to the Transaction Financing, including by consulting and cooperating with, and considering in good faith any feedback from, the other or its financial advisors (if any) engaged for the purposes of this Transactions with respect to such matters.

Section 10.9. Transaction Financing. Each of the Acquiror Parties and the Company shall use reasonable best efforts to take, or cause to be taken, all actions and do, or cause to be done, all things necessary, proper or advisable to consummate the transactions contemplated by the Transaction Financing Agreements, including maintaining in effect such agreements and to satisfy on a timely basis all conditions and covenants applicable to it in the Transaction Financing Agreements and otherwise comply with its obligations thereunder to consummate transactions contemplated by the Transaction Financing Agreements at or prior to the Share Exchange Closing.

Section 10.10. Joining Seller The Parties agree that at any time after the date hereof and prior to the Share Exchange Closing, each shareholder of the Company that is not a Signing Seller can become a Joining Seller after the Proxy/Registration Statement having been declared effective by the SEC by duly executing and delivering to the Company and the Acquiror (on behalf of all Acquiror Parties) a joinder agreement in the form attached hereto as Exhibit G (the “BCA Joinder”) to become a party to this Agreement which joinder agreement shall include an agreement by such shareholder of the Company to be bound by the terms and conditions of this Agreement applicable to the Seller and an acknowledgment by such shareholder of the Company that he/she/it has received the Proxy/Registration Statement prospectus with respect to the Transactions. The Company shall use reasonable best efforts to procure that each holder of the Purchased Shares is either a Signing Seller or a Joining Seller. For the avoidance of doubt, in no event shall a shareholder of the Company that is not a Company Insider be a party to this Agreement prior to the SEC’s declaration of effectiveness of the Proxy/Registration Statement. None of the Company and the Acquiror Parties shall acknowledge or accept a BCA Joinder by a shareholder of the Company that is not a Company Insider prior to the effective date of the Proxy/Registration Statement.

Section 10.11. Key Person Agreements.

(a) Each Seller holding 10% or more of the Purchased Shares immediately prior to the Share Exchange Closing agrees that such Seller shall enter into the Non-Disclosure, Non-Competition and Non-Solicitation Agreement; and

(b) Each of the Company and the Acquiror Parties shall procure the execution and delivery of PubCo Employment Agreement by each PubCo executive officers on or prior to the Share Exchange Closing.

Section 10.12. Post-Combination Directors and Officers of PubCo. Each of the Acquiror Parties and the Company shall take all such action within its power as may be necessary or appropriate such that upon the Share Exchange Closing:

(a) the board of directors of PubCo shall consist of seven (7) directors consisting of seven (7) directors designated by the Company prior to the Share Exchange Closing (including two (2) independent directors that are qualified as “independent” under Nasdaq rules) that satisfy Nasdaq Diverse Board Representation Rule provided that the Company shall cause PubCo after the Share Exchange to comply with applicable Nasdaq rule to follow a home country practice; and

(b) the officers of PubCo shall consist of the officers of the Company as of immediately prior to the Share Exchange Closing, who shall serve in such capacity in accordance with the terms of PubCo’s Governing Documents following the Share Exchange Closing, until their respective successors are duly elected or appointed and qualified

Section 10.13. D&O Indemnification and Insurance.

(a) From and after the Share Exchange Closing, each of the Company and Surviving Corporation agrees that it shall, to the fullest extent permitted under applicable Law, indemnify and hold harmless each present and former director and officer of the (x) Company and each of its Subsidiaries (in each case, solely to the extent acting in their capacity as such and to the extent such activities are related to the business of the Company being acquired under this Agreement) (the “Company Indemnified Parties”) and (y) Acquiror and each of its Subsidiaries (the “Acquiror Indemnified Parties” together with the Company Indemnified Parties, the “D&O Indemnified Parties”) against any costs or expenses (including reasonable attorneys’ fees), judgments, fines, losses, claims, damages or liabilities incurred in connection with any Legal Proceeding, whether civil, criminal, administrative or investigative, arising out of or pertaining to matters existing or occurring at or prior to the Share Exchange Closing, whether asserted or claimed prior to, at or after the Share Exchange Closing, to the fullest extent that the Company, Acquiror or their respective Subsidiaries, as the case may be, would have been permitted under applicable Law and each of their respective certificate of incorporation, certificate of formation, bylaws, limited liability company agreement or other organizational documents in effect on the date of this Agreement to indemnify such D&O Indemnified Parties (including the advancing of expenses as incurred to the fullest extent permitted under applicable Law). Without limiting the foregoing, the Surviving Corporation and the Company shall, and shall cause their Subsidiaries to (i) maintain for a period of not less than six (6) years from the Share Exchange Closing provisions in their respective Governing Documents concerning the indemnification and exoneration (including provisions relating to expense advancement) of the Company’s, Acquiror’s and their Subsidiaries’ former and current officers, directors, employees, and agents that are no less favorable to those Persons than the provisions of the Governing Documents of the Company, Acquiror or their respective Subsidiaries, as applicable, in each case, as of the date of this Agreement, and (ii) not amend, repeal or otherwise modify such provisions in any respect that would adversely affect the rights of those Persons thereunder, in each case, except as required by applicable Laws.

(b) For a period of six (6) years from the Share Exchange Closing, the PubCo shall maintain in effect directors’ and officers’ liability insurance covering those Persons who are currently covered by Acquiror’s, the Company’s or their respective Subsidiaries’ directors’ and officers’ liability insurance policies (true, correct and complete copies of which have been heretofore made available to the Company, Acquiror or their respective Representatives, as applicable) on terms not less favorable than the terms of such current insurance coverage, except that in no event shall the PubCo be required to pay an annual premium for such insurance in excess of three hundred percent (300%) of the aggregate annual premium payable by Acquiror or the Company, as applicable, for such insurance policy for the year ended December 31, 2021; provided, that (i) the PubCo may cause coverage to be extended under the current directors’ and officers’ liability insurance by obtaining a six (6) year “tail” policy containing terms not materially less favorable than the terms of such current insurance coverage with respect to claims existing or occurring at or prior to the Share Exchange Closing and (ii) if any claim is asserted or made within such six (6) year period, any insurance required to be maintained under this Section 10.13 shall be continued in respect of such claim until the final disposition thereof.

(c) Notwithstanding anything contained in this Agreement to the contrary, (i) this Section 10.13 shall survive the Share Exchange Closing indefinitely and shall be binding, jointly and severally, on the PubCo, the Surviving Corporation and the Company and all of their respective successors and assigns; and (ii) in the event that the PubCo, the Surviving Corporation or the Company or any of their successors or assigns consolidates with or merges into any other Person and shall not be the continuing or surviving corporation or entity of such consolidation or merger or transfers or conveys all or substantially all of its properties and assets to any Person, then, and in each such case, each of the PubCo, the Surviving Corporation and the Company shall ensure that proper provision shall be made so that the successors and assigns of the PubCo, the Surviving Corporation and the Company, as applicable, shall succeed to the obligations set forth in this Section 10.13.

(d) On the Share Exchange Closing Date, PubCo shall enter into customary indemnification agreements reasonably satisfactory to each of the Company and Acquiror with the directors and officers of PubCo after the consummation of the business combination contemplated hereby, which indemnification agreements shall continue to be effective following the Share Exchange Closing.

(e) The provisions of this Section 10.13: (i) are intended to be for the benefit of, and shall be enforceable by, each Person who is now, or who has been at any time prior to the date of this Agreement or who becomes prior to the Share Exchange Closing, a D&O Indemnified Party, his or her heirs and his or her personal representatives, (ii) shall be binding on the PubCo, the Surviving Corporation and the Company and their respective successors and assigns, (iii) are in addition to, and not in substitution for, any other rights to indemnification or contribution that any such Person may have, whether pursuant to Law, Contract, Governing Documents, or otherwise, and (iv) shall survive the consummation of the business combination and shall not be terminated or modified in such a manner as to adversely affect any D&O Indemnified Party without the prior written consent of such D&O Indemnified Party.

Section 10.14. Antitrust Laws. Without limiting the generality of Section 10.1 and Section 10.3, to the extent required under any Laws that are designed to prohibit, restrict or regulate actions having the purpose or effect of monopolization or restraint of trade ("Antitrust Laws"), each party hereto agrees to make any required filing or application under Antitrust Laws, as applicable, in each case, at such party's sole cost and expense, with respect to the transactions contemplated hereby as promptly as practicable, to supply as promptly as reasonably practicable any additional information and documentary material that may be reasonably requested pursuant to Antitrust Laws and to take all other actions reasonably necessary, proper or advisable to cause the expiration or termination of the applicable waiting periods under Antitrust Laws as soon as practicable, including by requesting early termination of the waiting period provided for under the Antitrust Laws. Each party hereto shall, in connection with its efforts to obtain all requisite approvals and authorizations for the transactions contemplated by this Agreement under any Antitrust Law, use its commercially reasonable efforts to: (i) cooperate in all respects with each other party hereto or its Affiliates in connection with any filing or submission and in connection with any investigation or other inquiry, including any proceeding initiated by a private Person; (ii) keep the other parties reasonably informed of any communication received by such party or its Representatives from, or given by such party or its Representatives to, any Governmental Authority and of any communication received or given in connection with any proceeding by a private Person, in each case regarding any of the transactions contemplated by this Agreement; (iii) permit a Representative of the other Parties and their respective outside counsel to review any communication given by it to, and consult with each other in advance of any meeting or conference with, any Governmental Authority or, in connection with any proceeding by a private Person, with any other Person, and to the extent permitted by such Governmental Authority or other Person, give a Representative or Representatives of the other Parties the opportunity to attend and participate in such meetings and conferences; (iv) in the event a Representative of a party hereto is prohibited from participating in or attending any meetings or conferences, the other parties hereto shall keep such party promptly and reasonably apprised with respect thereto; and (v) use commercially reasonable efforts to cooperate in the filing of any memoranda, white papers, filings, correspondence or other written communications explaining or defending the transactions contemplated hereby, articulating any regulatory or competitive argument, and/or responding to requests or objections made by any Governmental Authority.

Section 10.15. Shareholder Litigation

(a) In the event that any litigation related to this Agreement, any other Transaction Document or the transactions contemplated hereby or thereby is brought, or, to the knowledge of the Company, threatened in writing, against the Company or any of its Subsidiaries or the board of directors of the Company or any of its Subsidiaries by any Company Shareholders prior to the Share Exchange Closing, the Company shall promptly after becoming aware of such litigation notify Acquiror, New SubCo and PubCo of such litigation and keep Acquiror, New SubCo and PubCo reasonably informed with respect to the status thereof; and the Company shall provide Acquiror, New SubCo and PubCo the opportunity to participate in (at its own cost and expense and subject to a customary joint defense agreement), but not control, the defense of any such litigation and shall consider in good faith Acquiror's, New SubCo's and/or PubCo's suggestions with respect to such litigation, and shall not settle any such litigation without the prior written consent of Acquiror, New SubCo and PubCo, such consent not to be unreasonably withheld, conditioned, or delayed.

(b) In the event that any litigation related to this Agreement, any other Transaction Document or the transactions contemplated hereby or thereby is brought, or, to the knowledge of the Acquiror Parties, threatened in writing, against any Acquiror Party or the board of directors of any Acquiror Party by any shareholder of any Acquiror Party prior to the Share Exchange Closing, such Acquiror Party shall promptly after becoming aware of such litigation notify the Company of such litigation and keep the Company reasonably informed with respect to the status thereof; and such Acquiror Party shall provide the Company the opportunity to participate in (at its own cost and expense and subject to a customary joint defense agreement), but not control, the defense of any such litigation and shall consider in good faith the Company's suggestions with respect to such litigation, and shall not settle any such litigation without the prior written consent of the Company, such consent not to be unreasonably withheld, conditioned, or delayed.

## ARTICLE XI

### CONDITIONS TO OBLIGATIONS

Section 11.1. Conditions of each Party's Obligations. The obligations of each party hereto to consummate, or cause to be consummated, the Combination is subject to the satisfaction of the following conditions, any one or more of which may be waived in writing by all of such parties:

(a) the Acquiror Shareholder Approval shall have been obtained;

(b) the Company Shareholder Approval shall have been obtained;

(c) the Proxy/Registration Statement shall have become effective under the Securities Act and no stop order suspending the effectiveness of the Proxy/Registration Statement shall have been issued and no proceedings for that purpose shall have been initiated or threatened by the SEC and not withdrawn;

(d) (i) PubCo's initial listing application as a foreign private issuer with the Nasdaq in connection with the Transactions shall have been conditionally approved and, immediately following the Share Exchange Closing, PubCo shall satisfy any applicable listing requirements of the Nasdaq and PubCo shall not have received any written notice of non-compliance therewith, and (ii) the PubCo Securities to be issued in connection with the Transactions shall have been approved for listing on the Nasdaq, subject to official notice of issuance;

(e) no Governmental Authority shall have enacted, issued, promulgated, enforced or entered any Law (whether temporary, preliminary or permanent) or Governmental Order that is then in effect and which has the effect of making the Merger Closing or the Share Exchange Closing illegal or which otherwise prevents or prohibits consummation of the Merger Closing or the Share Exchange Closing (any of the foregoing, a "restraint"), other than any such restraint that is immaterial, or for which the relevant Governmental Authority does not have jurisdiction over any of the parties hereto with respect to the Transactions;

(f) there shall have been no Company Material Adverse Effect; and

(g) PubCo shall have at least \$5,000,001 of net tangible assets (as determined in accordance with Rule 3a51 1(g)(1) of the Exchange Act) upon the Share Exchange Closing.

Section 11.2. Conditions to Obligations of Acquiror, Merger Sub and PubCo at Merger Closing. The obligations of Acquiror, Merger Sub and PubCo to consummate, or cause to be consummated, the Merger are subject to the satisfaction of the following additional conditions, any one or more of which may be waived in writing by Acquiror:

(a) each of the representations and warranties of the Sellers contained in Article IV and of the Company contained in Article V of this Agreement shall be true and correct in all material respects as of the Merger Closing Date, except with respect to such representations (disregarding any qualifications and exceptions contained therein relating to materiality, material adverse effect or any similar qualification or exception) and warranties which speak as to an earlier date, which representations and warranties (disregarding any qualifications and exceptions contained therein relating to materiality, material adverse effect or any similar qualification or exception) shall be true and correct in all material respects at and as of such date; and

(b) each of the covenants of the Company and the Sellers to be performed as of or prior to the Merger Closing shall have been performed in all material respects.

Section 11.3. Conditions to Obligations of PubCo, New SubCo, the Company and the Sellers at Share Exchange Closing. The obligations of PubCo, New SubCo, the Company and the Sellers to consummate, or cause to be consummated, the Share Exchange is subject to the satisfaction of the following conditions, any one or more of which may be waived in writing by all of such parties:

(a) the Merger Closing shall have occurred;

(b) since the Merger Effective Time, no stop order suspending the effectiveness of the Proxy/Registration Statement shall have been issued and no proceedings for that purpose shall have been initiated or threatened by the SEC and not withdrawn;

(c) since the Merger Effective Time, (i) PubCo shall continue to satisfy any applicable initial and continuing listing requirements of the Nasdaq and PubCo shall not have received any written notice of non-compliance therewith, and (ii) the PubCo Shares to be issued in connection with the Share Exchange shall continue to be approved for listing on the Nasdaq, subject to official notice of issuance; and

(d) since the Merger Effective Time, no Governmental Authority shall have enacted, issued, promulgated, enforced or entered any Law (whether temporary, preliminary or permanent) or Governmental Order that is then in effect and which has the effect of making the Share Exchange Closing illegal or which otherwise prevents or prohibits consummation of the Share Exchange Closing (any of the foregoing, a “share exchange restraint”), other than any such share exchange restraint that is immaterial or for which the relevant Governmental Authority does not have jurisdiction over any of the parties hereto with respect to the Transactions.

Section 11.4. Additional Conditions to the Obligations of PubCo and New SubCo at Share Exchange Closing. The obligations of PubCo and New SubCo to consummate, or cause to be consummated, the Share Exchange is subject to the satisfaction of the following additional conditions, any one or more of which may be waived in writing by PubCo:

(a) each of the representations and warranties of the Sellers contained in Article IV, and of the Company contained in Article V shall be true and correct as of the Share Exchange Closing Date in all material respects, except with respect to such representations and warranties which speak as to an earlier date, which representations and warranties (disregarding any qualifications and exceptions contained therein relating to materiality, material adverse effect or any similar qualification or exception) shall be true and correct in all material respects at and as of such date;

(b) each of the covenants of the Company to be performed as of or prior to the Share Exchange Closing shall have been performed in all material respects;

(c) with respect to each Seller, (i) each of the representations and warranties of such Seller contained in Article IV shall be true and correct as of the Share Exchange Closing Date in all material respects, except with respect to such representations and warranties which speak as to an earlier date, which representations and warranties (disregarding any qualifications and exceptions contained therein relating to materiality, material adverse effect or any similar qualification or exception) shall be true and correct in all material respects at and as of such date, except for, in each case under this Section 11.4(c), inaccuracies or omissions that would not reasonably be expected to have, individually or in the aggregate, a material adverse effect on the ability of such Seller to enter into and perform its obligations under this Agreement; and (ii) each of the covenants of such Seller to be performed as of or prior to the Share Exchange Closing shall have been performed in all material respects; and

(d) all Transaction Documents shall have been executed and delivered by the other parties thereto and been in full force and effect in accordance with the terms thereof as of the Share Exchange Closing

Section 11.5. Additional Conditions to the Obligations of the Company and the Sellers at Share Exchange Closing. The obligations of the Sellers and the Company to consummate, or cause to be consummated, the Share Exchange is subject to the satisfaction of the following additional conditions, any one or more of which may be waived in writing by the Company:



(a) each of the representations and warranties of Acquiror contained in Article VI, and of Acquisition Entities contained in Article VII shall be true and correct as of the Share Exchange Closing Date in all material respects (disregarding any qualifications and exceptions contained therein relating to materiality, material adverse effect or any similar qualification or exception), except with respect to such representations and warranties which speak as to an earlier date, which representations and warranties (disregarding any qualifications and exceptions contained therein relating to materiality, material adverse effect or any similar qualification or exception) shall be true and correct at and as of such date, except for, in each case under this Section 11.5(a), inaccuracies or omissions that would not reasonably be expected to have, individually or in the aggregate, a material adverse effect on the ability of Acquiror or Acquisition Entities to enter into and perform its obligations under this Agreement;

(b) each of the covenants of Acquiror, PubCo and New SubCo to be performed as of or prior to the Share Exchange Closing shall have been performed in all material respects;

(c) the Available Acquiror Cash shall be at least \$20,000,000 immediately prior to or upon the Share Exchange Closing;

(d) the Post-Combination PubCo Charter and PubCo ESOP shall have been duly adopted and shall have remained in full force and effect;

(e) each of the Acquiror Parties shall have delivered to the Company a good standing certificate (or similar documents applicable for the relevant Acquiror Party in its jurisdiction of incorporation) for such Acquiror Party certified as of a date no earlier than twenty (20) days prior to the Share Exchange Closing Date from the proper Governmental Authority of such Acquisition Entity's jurisdiction of organization and from each other jurisdiction in which such Acquisition Entity is qualified to do business as a foreign entity as of the Share Exchange Closing, in each case to the extent that good standing certificates or similar documents are generally available in such jurisdictions;

(f) the Company and PubCo shall have received copies of the executed Transaction Financing Agreements from the investors in connection with the Transaction Financing, in each case in such form satisfactory to the Company.

(g) all Transaction Documents shall have been executed and delivered by the other parties thereto and been in full force and effect in accordance with the terms thereof as of the Share Exchange Closing.

Section 11.6. Frustration of Conditions Notwithstanding anything contained herein to the contrary, no party hereto may rely on the failure of any condition set forth in this Article IX to be satisfied if such failure was caused by the failure of such party hereto or its Affiliates to comply with or perform any of its covenants or obligations set forth in this Agreement. For the avoidance of doubt, the occurrence of any Company Material Adverse Effect shall not be the fault of any party unless such Company Material Adverse Effect is a result of the breach of this Agreement or any other Transaction Document by any particular party hereto, in which case such breaching party cannot rely on the non-satisfaction of Section 11.1(f) to not proceed with the Combination.

## ARTICLE XII

### TERMINATION/EFFECTIVENESS

Section 12.1. Termination. This Agreement may be terminated and the transactions contemplated hereby abandoned:

(a) by mutual written consent of the Company and Acquiror;

(b) by the Company or Acquiror if any Governmental Authority shall have enacted, issued, promulgated, enforced or entered any Law (whether temporary, preliminary or permanent) or Governmental Order that is then in effect and which has the effect of making the Merger Closing or Share Exchange Closing illegal or which otherwise prevents or prohibits consummation of the Merger Closing or Share Exchange Closing, other than any such restraint that is immaterial;

(c) by the Company if the Acquiror Shareholder Approval shall not have been obtained by reason of the failure to obtain the required vote at the Acquiror Shareholders' Meeting duly convened therefor or at any adjournment or postponement thereof; and

(d) prior to the Merger Closing by written notice to the Company from Acquiror if (i) there is any breach of any representation, warranty, covenant or agreement on the part of the Company set forth in this Agreement, such that the conditions specified in Section 11.2(a) or Section 11.2(b) would not be satisfied at the Merger Closing (a "Terminating Company Breach"), except that, if such Terminating Company Breach is curable by the Company through the exercise of its reasonable best efforts, then, for a period of up to thirty (30) days after receipt by the Company of notice from Acquiror of such breach, but only as long as the Company continues to use its reasonable best efforts to cure such Terminating Company Breach (the "Company Cure Period"), such termination shall not be effective, and such termination shall become effective only if (i) the Terminating Company Breach is not cured within the Company Cure Period, or (ii) the Merger Closing has not occurred on or before the Long Stop Date, unless any Acquiror Party is in material breach of this Agreement.

(e) prior to the Merger Closing by written notice to Acquiror from the Company if (i) there is any breach of any representation, warranty, covenant or agreement on the part of any Acquiror Party set forth in this Agreement, such that the conditions specified in Section 11.5(a) and Section 11.5(b) would not be satisfied at the Share Exchange Closing (a "Terminating Acquiror Breach"), except that, if any such Terminating Acquiror Breach is curable by the relevant Acquiror Party, PubCo or New SubCo, as applicable, through the exercise of its reasonable best efforts, then, for a period of up to thirty (30) days after receipt by Acquiror of notice from the Company of such breach, but only as long as the relevant Acquiror Party continues to exercise such reasonable best efforts to cure such Terminating Acquiror Breach (the "Acquiror Cure Period"), such termination shall not be effective, and such termination shall become effective only if (i) the Terminating Acquiror Breach is not cured within the Acquiror Cure Period, or (ii) the Merger Closing has not occurred on or before the Long Stop Date, unless the Company or a Seller is in material breach of this Agreement.

Section 12.2. Effect of Termination. In the event of the termination of this Agreement pursuant to Section 12.1, this Agreement shall forthwith become void and have no effect, without any liability on the part of any party hereto or its respective Affiliates, officers, directors or shareholders, other than liability of the Company, any Acquiror Party or any Seller, as the case may be, for any willful and material breach of this Agreement occurring prior to such termination, except that the provisions of Section 10.4, Section 10.5, Section 10.6, this Section 12.2 and Article XIII shall survive any termination of this Agreement.

### ARTICLE XIII

#### MISCELLANEOUS

Section 13.1. Trust Account Waiver. Each of the Sellers, the Company, PubCo, Merger Sub and New SubCo hereby represents and warrants that it has read Acquiror IPO Prospectus available at [www.sec.report](http://www.sec.report), and understands that Acquiror has established a trust account (the "Trust Account") containing the proceeds of its initial public offering (the "IPO") and the over-allotment shares acquired by its underwriters and from certain private placements occurring simultaneously with the IPO (including interest accrued from time to time thereon) for the benefit of Acquiror's public shareholders (including the public shareholders of the over-allotment shares acquired by Acquiror's underwriters, the "Public Shareholders"), and that, except as otherwise described in the Acquiror IPO Prospectus, Acquiror may disburse monies from the Trust Account only: (a) to the Public Shareholders with respect to Acquiror Share Redemptions, (b) to the Public Shareholders if Acquiror fails to consummate a Business Combination within 12 months after the closing of the IPO, subject to extension by an amendment to Acquiror's organizational documents, (c) with respect to any interest earned on the amounts held in the Trust Account, amounts necessary to pay for any taxes and up to \$100,000 in dissolution expenses or (d) to Acquiror after or concurrently with the consummation of a Business Combination. Each of the Sellers, the Company, PubCo, Merger Sub and New SubCo hereby agrees on behalf of itself and its Affiliates that, notwithstanding anything to the contrary in this Agreement (other than in Section 9.1), none of the Sellers, the Company, PubCo, Merger Sub and New SubCo or any of their respective Affiliates do now or shall at any time hereafter have any right, title, interest or claim of any kind in or to any monies in the Trust Account or distributions therefrom, or make any claim against the Trust Account (including any distributions therefrom) in connection with any claim that arises as a result of, in connection with, or relating to this Agreement or any other Transaction Document, regardless of whether such claim arises based on contract, tort, equity or any other theory of legal liability under any Transaction Document (collectively, the "Released Claims"). Each of the Sellers, the Company, PubCo, Merger Sub and New SubCo, on behalf of itself and its Affiliates, hereby irrevocably waives any Released Claims Each of the Sellers, the Company, PubCo, Merger Sub and New SubCo or any of their respective Affiliates may have against the Trust Account (including any distributions therefrom) now or in the future and will not seek recourse against the Trust Account (including any distributions therefrom) in connection with any Released Claims (including for an alleged breach of this Agreement or any other Transaction Document). Each of the Sellers, the Company, PubCo, Merger Sub and New SubCo agrees and acknowledges that such irrevocable waiver is material to this Agreement and specifically relied upon by Acquiror and its Affiliates to induce Acquiror to enter into the Transaction Documents, and each of the Sellers, the Company, PubCo, Merger Sub and New SubCo further intends and understands such waiver to be valid, binding and enforceable against the Sellers, the Company, PubCo, Merger Sub and New SubCo and each of their respective Affiliates under applicable Law. To the extent the Sellers, the Company, PubCo, Merger Sub and New SubCo or any of their respective Affiliates commences any action or proceeding based upon, in connection with or relating to any Released Claim, which action or proceeding seeks, in whole or in part, monetary relief against Acquiror or its Representatives, each of the Sellers, the Company, PubCo, Merger Sub and New SubCo hereby acknowledges and agrees that each such Sellers, the Company's, PubCo's, Merger Sub's, New SubCo's and each of their respective Affiliates' sole remedy shall be against funds held outside of the Trust Account and that such claim shall not permit the Sellers, the Company, PubCo, Merger Sub and New SubCo or any of their respective Affiliates (or any person claiming on any of their behalves or in lieu of any of them) to have any claim against the Trust Account (including any distributions therefrom) or any amounts contained therein. In the event the Sellers, the Company, PubCo, Merger Sub and New SubCo or any of their respective Affiliates commences any action or proceeding based upon, in connection with or relating to any Released Claim, which proceeding seeks, in whole or in part, relief against the Trust Account (including any distributions therefrom) or the Public Shareholders, whether in the form of money damages or injunctive relief or otherwise, Acquiror and its Representatives, as applicable, shall be entitled to recover Sellers, the Company, PubCo, Merger Sub and New SubCo and their respective Affiliates the associated legal fees and costs in connection with any such action, in the event Acquiror or its Representatives, as applicable, prevails in such action or proceeding.

Section 13.2. Waiver. Any party to this Agreement may, at any time prior to the Share Exchange Closing, by action taken by its board of directors or other officers or Persons thereunto duly authorized, (a) extend the time for the performance of the obligations or acts of the other parties hereto, (b) waive any inaccuracies in the representations and warranties (of another party hereto) that are contained in this Agreement or (c) waive compliance by the other parties hereto with any of the agreements or conditions contained in this Agreement, but such extension or waiver shall be valid only if set forth in an instrument in writing signed by the party granting such extension or waiver.

Section 13.3. Notices. All general notices, demands or other communications required or permitted to be given or made hereunder shall be in writing and delivered personally or sent by courier or sent by registered post or sent by electronic mail to the intended recipient thereof at its address or at its email address set out below (or to such other address or email address as a party may from time to time notify the other parties). Any such notice, demand or communication shall be deemed to have been duly served (a) if given personally or sent by courier, upon delivery during normal business hours at the location of delivery or, if later, then on the next Business Day after the day of delivery; (b) if sent by electronic mail during normal business hours at the location of delivery, immediately, or, if later, then on the next Business Day after the day of delivery; (c) the third Business Day following the day sent by reputable international overnight courier (with written confirmation of receipt); and (d) if sent by registered post, five (5) days after posting. The initial addresses and email addresses of the parties for the purpose of this Agreement are:

- (a) If to Acquiror, Merger Sub, PubCo (prior to the Combination) or New SubCo (prior to the Combination) to:

Prime Number Acquisition I Corp.  
1129 Northern Blvd., Suite 404  
Manhasset, NY 11030  
Attention: Dongfeng Wang  
Email: 161160@gmail.com

with copies to (which shall not constitute notice):

Robinson & Cole LLP  
666 Third Avenue, 20<sup>th</sup> Floor  
New York, NY 10017  
Attention: Arila E. Zhou  
Email: azhou@rc.com

- (b) If to PubCo (after the Combination) or New SubCo (after the Combination), to:

Noco-Noco Pte. Ltd.  
#04-06 SGX Centre 2, Singapore  
Attention: Kenneth Lim  
Email: kenneth.lim@3dom.co.jp

(c) If to the Company or the Sellers, to:

Noco-Noco Pte. Ltd.  
#04-06 SGX Centre 2, Singapore  
Attention: Kenneth Lim  
Email: kenneth.lim@3dom.co.jp

with copies to (which shall not constitute notice):

Sidley Austin LLP  
39/F, Two Int'l Finance Centre  
Central, Hong Kong  
Attention: Raymond Oh  
Email: roh@sidley.com

or to such other address or addresses as the parties may from time to time designate in writing. Copies delivered solely to outside counsel shall not constitute notice.

Section 13.4. Assignment. Subject to Section 10.10, no party hereto shall assign this Agreement or any part hereof without the prior written consent of the other parties and any such transfer without the prior written consent shall be void. Subject to the foregoing, this Agreement shall be binding upon and inure to the benefit of the parties hereto and their respective permitted successors and assigns.

Section 13.5. Rights of Third Parties. Nothing expressed or implied in this Agreement is intended or shall be construed to confer upon or give any Person, other than the parties hereto, any right or remedies under or by reason of this Agreement; provided, that (a) the D&O Indemnified Parties may enforce Section 10.13; and (b) the Non-Recourse Parties may enforce Section 13.16.

Section 13.6. Expenses. Except as otherwise set forth in this Agreement, each party hereto shall be responsible for and pay its own expenses incurred in connection with this Agreement and the transactions contemplated hereby, including all fees of its legal counsel, financial advisers and accountants; provided, that if the Share Exchange Closing shall occur, the Company shall pay or cause to be paid the Acquiror Transaction Expenses and the Company Transaction Expenses in accordance with Section 3.5.

Section 13.7. Headings; Counterparts. The headings in this Agreement are for convenience only and shall not be considered a part of or affect the construction or interpretation of any provision of this Agreement. This Agreement may be executed in two or more counterparts, each of which shall be deemed an original, but all of which together shall constitute one and the same instrument.

Section 13.8. Electronic Execution of the Agreement and Certain Other Documents. The words “execution,” “execute,” “signed,” “signature,” and words of like import in or related to this Agreement or any Transaction Document (including, without limitation, any related amendments, waivers and consents) shall be deemed to include electronic signatures, the electronic matching of assignment terms and contract formations on electronic platforms complying with applicable law, or the keeping of records in electronic form, each of which shall be of the same legal effect, validity or enforceability as a manually executed signature or the use of a paper-based recordkeeping system, as the case may be, to the extent and as provided for in any applicable law, including the Federal Electronic Signatures in Global and National Commerce Act, the Delaware Uniform Electronic Transactions Act, the New York State Electronic Signatures and Records Act, or any other similar state laws based on the Uniform Electronic Transactions Act.

Section 13.9. Company Disclosure Letter. The Company Disclosure Letter (including any section thereof) referenced herein are a part of this Agreement as if fully set forth herein. All references herein to the Company Disclosure Letter (including any section thereof) shall be deemed references to such parts of this Agreement, unless the context shall otherwise require. Any disclosure made in the Company Disclosure Letter, or any section thereof, with reference to any section of this Agreement or section of the Company Disclosure Letter shall be deemed to be a disclosure with respect to such other applicable sections of this Agreement or sections of the Company Disclosure Letter only if it is reasonably apparent on the face of such disclosure that such disclosure is responsive to such other section of this Agreement or section of the applicable Disclosure Letter. Certain information set forth in the Company Disclosure Letters is included solely for informational purposes and may not be required to be disclosed pursuant to this Agreement. The disclosure of any information shall not be deemed to constitute an acknowledgment that such information is required to be disclosed in connection with the representations and warranties made in this Agreement, nor shall such information be deemed to establish a standard of materiality.

Section 13.10. Entire Agreement. This Agreement (together with the Company Disclosure Letter) and the other Transaction Documents constitute the entire agreement among the parties to this Agreement relating to the transactions contemplated hereby and supersede any other agreements, whether written or oral, that may have been made or entered into by or among any of the parties hereto or any of their respective Subsidiaries relating to the transactions contemplated hereby. No representations, warranties, covenants, understandings, agreements, oral or otherwise, relating to the transactions contemplated hereby exist between such parties except as expressly set forth in this Agreement and the other Transaction Documents.

Section 13.11. Amendments. This Agreement may be amended or modified in whole or in part, only by a duly authorized agreement in writing executed in the same manner as this Agreement and which makes reference to this Agreement; provided, that after the Company Shareholder Approval or the Acquiror Shareholder Approval has been obtained, there shall be no amendment or waiver that by applicable Law requires further approval by the Company Shareholders or the Acquiror Shareholders, respectively, without such approval having been obtained.

Section 13.12. Severability. If any provision of this Agreement is held invalid or unenforceable by any court of competent jurisdiction, the other provisions of this Agreement shall remain in full force and effect. The parties further agree that if any provision contained herein is, to any extent, held invalid or unenforceable in any respect under the Laws governing this Agreement, they shall take any actions necessary to render the remaining provisions of this Agreement valid and enforceable to the fullest extent permitted by Law and, to the extent necessary, shall amend or otherwise modify this Agreement to replace any provision contained herein that is held invalid or unenforceable with a valid and enforceable provision giving effect to the intent of the parties.

Section 13.13. Governing Law. This Agreement, and all claims or causes of action based upon, arising out of, or related to this Agreement or the transactions contemplated hereby, shall be governed by, and construed in accordance with, the Laws of the State of Delaware, without giving effect to principles or rules of conflict of Laws to the extent such principles or rules would require or permit the application of Laws of another jurisdiction.

Section 13.14. Jurisdiction; Waiver of Jury Trial.

(a) Any proceeding or Action based upon, arising out of or related to this Agreement or the transactions contemplated hereby must be brought in the Court of Chancery of the State of Delaware (or, to the extent such court does not have subject matter jurisdiction, the Superior Court of the State of Delaware), or, if it has or can acquire jurisdiction, in the United States District Court for the District of Delaware, and each of the parties irrevocably (i) submits to the exclusive jurisdiction of each such court in any such proceeding or Action, (ii) waives any objection it may now or hereafter have to personal jurisdiction, venue or to convenience of forum, (iii) agrees that all claims in respect of the proceeding or Action shall be heard and determined only in any such court, and (iv) agrees not to bring any proceeding or Action arising out of or relating to this Agreement or the transactions contemplated hereby in any other court. Nothing herein contained shall be deemed to affect the right of any party to serve process in any manner permitted by Law or to commence Legal Proceedings or otherwise proceed against any other party in any other jurisdiction, in each case, to enforce judgments obtained in any Action, suit or proceeding brought pursuant to this Section 13.14.

(b) EACH PARTY HERETO ACKNOWLEDGES AND AGREES THAT ANY CONTROVERSY WHICH MAY ARISE UNDER THIS AGREEMENT AND THE TRANSACTIONS CONTEMPLATED HEREBY IS LIKELY TO INVOLVE COMPLICATED AND DIFFICULT ISSUES, AND THEREFORE EACH SUCH PARTY HEREBY IRREVOCABLY, UNCONDITIONALLY AND VOLUNTARILY WAIVES ANY RIGHT SUCH PARTY MAY HAVE TO A TRIAL BY JURY IN RESPECT OF ANY ACTION, SUIT OR PROCEEDING DIRECTLY OR INDIRECTLY ARISING OUT OF OR RELATING TO THIS AGREEMENT OR ANY OF THE TRANSACTIONS CONTEMPLATED HEREBY.

Section 13.15. Enforcement. The parties hereto agree that irreparable damage could occur in the event that any of the provisions of this Agreement were not performed in accordance with their specific terms or were otherwise breached. It is accordingly agreed that the parties shall be entitled to seek an injunction or injunctions to prevent breaches of this Agreement and to specific enforcement of the terms and provisions of this Agreement, in addition to any other remedy to which any party is entitled at law or in equity. In the event that any Action shall be brought in equity to enforce the provisions of this Agreement, no party shall allege, and each party hereby waives the defense, that there is an adequate remedy at law, and each party agrees to waive any requirement for the securing or posting of any bond in connection therewith.

Section 13.16. Non-Recourse. Except in the case of claims against a Person in respect of such Person's fraud:

(a) this Agreement may only be enforced against, and any claim or cause of action based upon, arising out of, or related to this Agreement or the transactions contemplated hereby may only be brought against, the Persons that are expressly named as parties hereto and then only with respect to the specific obligations set forth herein with respect to such party; and

(b) except to the extent a party hereto (and then only to the extent of the specific obligations undertaken by such party hereto), (i) no past, present or future director, commissioner, officer, employee, incorporator, member, partner, shareholder, Representative or Affiliate of the the Sellers, the Company, PubCo, Merger Sub and New SubCo and (ii) no past, present or future director, commissioner, officer, employee, incorporator, member, partner, shareholder, Representative or Affiliate of any of the foregoing (collectively, the "Non-Recourse Parties") shall have any liability (whether in Contract, tort, equity or otherwise) for any one or more of the representations, warranties, covenants, agreements or other obligations or liabilities of any one or more of the Parties under this Agreement for any claim based on, arising out of, or related to this Agreement or the transactions contemplated hereby.

Section 13.17. Non-Survival of Representations, Warranties and Covenants. Except (x) as otherwise contemplated by Section 12.2 or (y) in the case of claims against a Person in respect of such Person's actual fraud, none of the representations, warranties, covenants, obligations or other agreements in this Agreement or in any certificate, statement or instrument delivered pursuant to this Agreement, including any rights arising out of any breach of such representations, warranties, covenants, obligations, agreements and other provisions, shall survive the Share Exchange Closing and each such representation, warranty, covenant, obligation, agreement and provision shall terminate and expire upon the occurrence of the Share Exchange Closing (and there shall be no liability after the Share Exchange Closing in respect thereof), except for (a) those covenants and agreements contained herein that by their terms expressly apply in whole or in part after the Share Exchange Closing and then only with respect to any breaches occurring after the Share Exchange Closing and (b) this Article XIII.



Section 13.18. New SubCo. New SubCo shall become a party to this Agreement by executing and delivering an additional counterpart signature page to this Agreement, and thereafter shall be deemed an “Acquisition Entity” for all purposes hereunder. No action or consent by the Company, the Sellers or any other Acquiror Party shall be required for such joinder to this Agreement by New SubCo. By delivering a counterpart signature page to this Agreement, New SubCo agrees and consents to be bound by the rights and obligations as “New SubCo” hereunder.

Section 13.19. PubCo. PubCo shall become a party to this Agreement by executing and delivering an additional counterpart signature page to this Agreement, and thereafter shall be deemed an “Acquisition Entity” for all purposes hereunder. No action or consent by the Company, the Sellers or any other Acquiror Party shall be required for such joinder to this Agreement by PubCo. By delivering a counterpart signature page to this Agreement, PubCo agrees and consents to be bound by the rights and obligations as “PubCo” hereunder.

[Remainder of page intentionally left blank]

IN WITNESS WHEREOF the parties have hereunto caused this Agreement to be duly executed as of the date first above written.

Acquiror

**Prime Number Acquisition I Corp.**

By: /s/ Dongfeng Wang  
Name: Dongfeng Wang  
Title: CEO and Chairman

Merger Sub

**Prime Number Merger Sub Inc.**

By: /s/ Dongfeng Wang  
Name: Dongfeng Wang  
Title: CEO and Chairman

[SIGNATURE PAGE]

---

IN WITNESS WHEREOF the undersigned has duly executed this Agreement as PubCo.

PubCo

**PRIME NUMBER HOLDING LIMITED**

By: /s/ Dongfeng Wang  
Name: Dongfeng Wang  
Title: Director

Date: 2/3/2023

[SIGNATURE PAGE]

---

IN WITNESS WHEREOF the undersigned has duly executed this Agreement as New SubCo.

New SubCo

**PRIME NUMBER NEW SUB PTE. LTD.**

By: /s/ Weixiong (Jeff) Cheong  
Name: Weixiong (Jeff) Cheong  
Title: Director

Date: 2/3/2023

[SIGNATURE PAGE]

---

IN WITNESS WHEREOF the parties have hereunto caused this Agreement to be duly executed as of the date first above written.

Company

**NOCO-NOCO PTE. LTD.**

By: /s/ Masataka Matsumura  
Name: Masataka Matsumura  
Title: Director and CEO

[SIGNATURE PAGE]

---

IN WITNESS WHEREOF the parties have hereunto caused this Agreement to be duly executed as of the date first above written.

Seller

**3DOM ALLIANCE INC.**

By: /s/ Masataka Matsumura  
Name: Masataka Matsumura  
Title: Director and CEO

[SIGNATURE PAGE]

---

IN WITNESS WHEREOF the parties have hereunto caused this Agreement to be duly executed as of the date first above written.

Seller

**FUTURE SCIENCE RESEARCH INC.**

By: /s/ Masato Tomitaku

Name: Masato Tomitaku

Title: CEO

[SIGNATURE PAGE]

---

## Annex I

## Allocation Schedule

As of the date of this Agreement:

<b>Seller Name</b>	<b>No. of Purchased Shares</b>	<b>Pro Rata Portion*</b>	<b>No. of PubCo Ordinary Shares allocated</b>
3DOM ALLIANCE INC.	237,908	73.13%	to be calculated
FUTURE SCIENCE RESEARCH INC.	27,438	8.43%	to be calculated

\*assuming all holders of the Company Ordinary Shares are Sellers.

---



# Certificate Of Incorporation

I, **SHANIA TIBBETTS-LIGHTBODY** Acting Assistant Registrar of Companies of the Cayman Islands  
DO HEREBY CERTIFY, pursuant to the Companies Act, that all requirements of the said  
Act in respect of registration were complied with by

## Prime Number Holding Limited

an Exempted Company incorporated in the Cayman Islands with Limited Liability with effect from the  
28th day of December Two Thousand Twenty-Two

Given under my hand and Seal at George Town in the  
Island of Grand Cayman this 28th day of December  
Two Thousand Twenty-Two



Acting Assistant Registrar of Companies,  
Cayman Islands.





**EXEMPTED** Company Registered and  
filed as No. 396482 On 28-Dec-2022



Acting Assistant Registrar

Dated 28 December 2022

**Companies Act (Revised)**

**Company Limited by Shares**

**Prime Number Holding Limited**

---

**MEMORANDUM OF ASSOCIATION**

---

**Ogier**

#VPF:FRQ44389#

Auth Code: D68643119218  
[www.verify.gov.ky](http://www.verify.gov.ky)



**EXEMPTED** Company Registered and  
filed as No. 396482 On 28-Dec-2022



Acting Assistant Registrar

**Companies Act (Revised)**

**Company Limited by Shares**

**Memorandum of Association**

**of**

**Prime Number Holding Limited**

- 1 The name of the Company is Prime Number Holding Limited.
- 2 The Company's registered office will be situated at the office of Ogier Global (Cayman) Limited, 89 Nexus Way, Camana Bay, Grand Cayman, KY1-9009, Cayman Islands or at such other place in the Cayman Islands as the directors may at any time decide.
- 3 The Company's objects are unrestricted. As provided by section 7(4) of the Companies Act (Revised), the Company has full power and authority to carry out any object not prohibited by any law of the Cayman Islands.
- 4 The Company has unrestricted corporate capacity. Without limitation to the foregoing, as provided by section 27 (2) of the Companies Act (Revised), the Company has and is capable of exercising all the functions of a natural person of full capacity irrespective of any question of corporate benefit.
- 5 Nothing in any of the preceding paragraphs permits the Company to carry on any of the following businesses without being duly licensed, namely:
  - (a) the business of a bank or trust company without being licensed in that behalf under the Banks and Trust Companies Act (Revised); or
  - (b) insurance business from within the Cayman Islands or the business of an insurance manager, agent, sub-agent or broker without being licensed in that behalf under the Insurance Act (Revised); or
  - (c) the business of company management without being licensed in that behalf under the Companies Management Act (Revised).
- 6 Unless licensed to do so, the Company will not trade in the Cayman Islands with any person, firm or corporation except in furtherance of its business carried on outside the Cayman Islands. Despite this, the Company may effect and conclude contracts in the Cayman Islands and exercise in the Cayman Islands any of its powers necessary for the carrying on of its business outside the Cayman Islands.
- 7 The Company is a company limited by shares and accordingly the liability of each member is limited to the amount (if any) unpaid on that member's shares.

Auth Code: D68643119218  
[www.verify.gov.ky](http://www.verify.gov.ky)



**EXEMPTED** Company Registered and  
filed as No. 396482 On 28-Dec-2022



Acting Assistant Registrar

- 8 The share capital of the Company is USD50,000 divided into 500,000,000 Ordinary shares of par value USD0.0001 each. However, subject to the Companies Act (Revised) and the Company's articles of association, the Company has power to do any one or more of the following:
- (a) to redeem or repurchase any of its shares; and
  - (b) to increase or reduce its capital; and
  - (c) to issue any part of its capital (whether original, redeemed, increased or reduced):
    - (i) with or without any preferential, deferred, qualified or special rights, privileges or conditions; or
    - (ii) subject to any limitations or restrictionsand unless the condition of issue expressly declares otherwise, every issue of shares (whether declared to be ordinary, preference or otherwise) is subject to this power; or
  - (d) to alter any of those rights, privileges, conditions, limitations or restrictions.
- 9 The Company has power to register by way of continuation as a body corporate limited by shares under the laws of any jurisdiction outside the Cayman Islands and to be deregistered in the Cayman Islands.

Auth Code: D68643119218  
[www.verify.gov.ky](http://www.verify.gov.ky)



**EXEMPTED** Company Registered and  
filed as No. 396482 On 28-Dec-2022



Acting Assistant Registrar

We, the subscriber to this memorandum of association, wish to be formed into a company pursuant to this memorandum; and we agree to take the number of shares in the capital of the Company shown opposite our name in the table below.

Dated 28 December 2022

Name and address of Subscriber	Number of shares taken	Signature
Ogier Global Subscriber (Cayman) Limited 89 Nexus Way Camana Bay Grand Cayman, KY1-9009 Cayman Islands	1	per: /s/ Corinne Cellier Name: Corinne Cellier Authorised Signatory

**Witness to above signature**

/s/ Yanique Arthurs

Name: Yanique Arthurs

Ogier Global (Cayman) Limited  
89 Nexus Way  
Camana Bay  
Grand Cayman, KY1-9009  
Cayman Islands

Occupation: Administrator

Auth Code: D68643119218  
[www.verify.gov.ky](http://www.verify.gov.ky)



*EXEMPTED* Company Registered and  
filed as No. 396482 On 28-Dec-2022



Acting Assistant Registrar

**Dated 28 December 2022**

**Companies Act (Revised)**

**Company Limited by Shares**

**Prime Number Holding Limited**

---

**ARTICLES OF ASSOCIATION**

---

**Ogier**

#VPF:FRQ44386#

Auth Code: E79632663205  
[www.verify.gov.ky](http://www.verify.gov.ky)

---



**EXEMPTED** Company Registered and  
filed as No. 396482 On 28-Dec-2022



Acting Assistant Registrar

## CONTENTS

<b>1</b>	<b>Definitions, interpretation and exclusion of Table A</b>	<b>1</b>
	Definitions	1
	Interpretation	3
	Exclusion of Table A Articles	4
<b>2</b>	<b>Shares</b>	<b>4</b>
	Power to issue Shares and options, with or without special rights	4
	Power to issue fractions of a Share	4
	Power to pay commissions and brokerage fees	4
	Trusts not recognised	5
	Power to vary class rights	5
	Effect of new Share issue on existing class rights	5
	Capital contributions without issue of further Shares	6
	No bearer Shares or warrants	6
	Treasury Shares	6
	Rights attaching to Treasury Shares and related matters	6
<b>3</b>	<b>Share certificates</b>	<b>7</b>
	Issue of share certificates	7
	Renewal of lost or damaged share certificates	7
<b>4</b>	<b>Lien on Shares</b>	<b>8</b>
	Nature and scope of lien	8
	Company may sell Shares to satisfy lien	8
	Authority to execute instrument of transfer	8
	Consequences of sale of Shares to satisfy lien	9
	Application of proceeds of sale	9
<b>5</b>	<b>Calls on Shares and forfeiture</b>	<b>9</b>
	Power to make calls and effect of calls	9
	Time when call made	10
	Liability of joint holders	10
	Interest on unpaid calls	10
	Deemed calls	10
	Power to accept early payment	10
	Power to make different arrangements at time of issue of Shares	11
	Notice of default	11
	Forfeiture or surrender of Shares	11
	Disposal of forfeited or surrendered Share and power to cancel forfeiture or surrender	11
	Effect of forfeiture or surrender on former Member	12
	Evidence of forfeiture or surrender	12
	Sale of forfeited or surrendered Shares	12

Auth Code: E79632663205

[www.verify.gov.ky](http://www.verify.gov.ky)



**EXEMPTED** Company Registered and  
filed as No. 396482 On 28-Dec-2022



Acting Assistant Registrar

<b>6</b>	<b>Transfer of Shares</b>	<b>13</b>
	Form of transfer	13
	Power to refuse registration	13
	Notice of refusal to register	13
	Power to suspend registration	13
	Fee, if any, payable for registration	13
	Company may retain instrument of transfer	13
<b>7</b>	<b>Transmission of Shares</b>	<b>13</b>
	Persons entitled on death of a Member	13
	Registration of transfer of a Share following death or bankruptcy	14
	Indemnity	14
	Rights of person entitled to a Share following death or bankruptcy	14
<b>8</b>	<b>Alteration of capital</b>	<b>15</b>
	Increasing, consolidating, converting, dividing and cancelling share capital	15
	Dealing with fractions resulting from consolidation of Shares	15
	Reducing share capital	16
<b>9</b>	<b>Redemption and purchase of own Shares</b>	<b>16</b>
	Power to issue redeemable Shares and to purchase own Shares	16
	Power to pay for redemption or purchase in cash or in specie	16
	Effect of redemption or purchase of a Share	17
<b>10</b>	<b>Meetings of Members</b>	<b>17</b>
	Power to call meetings	17
	Content of notice	18
	Period of notice	18
	Persons entitled to receive notice	18
	Publication of notice on a website	19
	Time a website notice is deemed to be given	19
	Required duration of publication on a website	19
	Accidental omission to give notice or non-receipt of notice	19
<b>11</b>	<b>Proceedings at meetings of Members</b>	<b>20</b>
	Quorum	20
	Lack of quorum	20
	Use of technology	20
	Chairman	20
	Right of a director to attend and speak	21
	Adjournment	21
	Method of voting	21
	Outcome of vote by show of hands	21
	Withdrawal of demand for a poll	21
	Taking of a poll	22
	Chairman's casting vote	22
	Amendments to resolutions	22

Auth Code: E79632663205  
[www.verify.gov.ky](http://www.verify.gov.ky)





**EXEMPTED** Company Registered and  
filed as No. 396482 On 28-Dec-2022



Acting Assistant Registrar

Written resolutions	23
Sole-member company	23
<b>12 Voting rights of Members</b>	<b>24</b>
Right to vote	24
Rights of joint holders	24
Representation of corporate Members	24
Member with mental disorder	25
Objections to admissibility of votes	25
Form of proxy	25
How and when proxy is to be delivered	26
Voting by proxy	27
<b>13 Number of directors</b>	<b>27</b>
<b>14 Appointment, disqualification and removal of directors</b>	<b>27</b>
First directors	27
No age limit	27
Corporate directors	27
No shareholding qualification	27
Appointment of directors	28
Removal of directors	28
Resignation of directors	28
Termination of the office of director	29
<b>15 Alternate directors</b>	<b>29</b>
Appointment and removal	29
Notices	30
Rights of alternate director	30
Appointment ceases when the appointor ceases to be a director	31
Status of alternate director	31
Status of the director making the appointment	31
<b>16 Powers of directors</b>	<b>31</b>
Powers of directors	31
Appointments to office	31
Remuneration	32
Disclosure of information	33
<b>17 Delegation of powers</b>	<b>33</b>
Power to delegate any of the directors' powers to a committee	33
Power to appoint an agent of the Company	33
Power to appoint an attorney or authorised signatory of the Company	34
Power to appoint a proxy	34
<b>18 Meetings of directors</b>	<b>34</b>
Regulation of directors' meetings	34

Auth Code: E79632663205  
[www.verify.gov.ky](http://www.verify.gov.ky)



**EXEMPTED** Company Registered and  
filed as No. 396482 On 28-Dec-2022



Acting Assistant Registrar

Calling meetings	35
Notice of meetings	35
Period of notice	35
Use of technology	35
Place of meetings	35
Quorum	35
Voting	35
Validity	35
Recording of dissent	36
Written resolutions	36
Sole director's minute	36
<b>19 Permissible directors' interests and disclosure</b>	<b>36</b>
Permissible interests subject to disclosure	36
Notification of interests	37
Voting where a director is interested in a matter	37
<b>20 Minutes</b>	<b>38</b>
<b>21 Accounts and audit</b>	<b>38</b>
Accounting and other records	38
No automatic right of inspection	38
Sending of accounts and reports	38
Time of receipt if documents are published on a website	39
Validity despite accidental error in publication on website	39
When accounts are to be audited	39
<b>22 Financial year</b>	<b>39</b>
<b>23 Record dates</b>	<b>40</b>
<b>24 Dividends</b>	<b>40</b>
Declaration of dividends by Members	40
Payment of interim dividends and declaration of final dividends by directors	40
Apportionment of dividends	41
Right of set off	41
Power to pay other than in cash	41
How payments may be made	41
Dividends or other moneys not to bear interest in absence of special rights	42
Dividends unable to be paid or unclaimed	42
<b>25 Capitalisation of profits</b>	<b>43</b>
Capitalisation of profits or of any share premium account or capital redemption reserve	43
Applying an amount for the benefit of members	43
<b>26 Share premium account</b>	<b>43</b>
Directors to maintain share premium account	43
Debits to share premium account	43

Auth Code: E79632663205  
[www.verify.gov.ky](http://www.verify.gov.ky)



**EXEMPTED** Company Registered and  
filed as No. 396482 On 28-Dec-2022



Acting Assistant Registrar

<b>27</b>	<b>Seal</b>	<b>44</b>
	Company seal	44
	Duplicate seal	44
	When and how seal is to be used	44
	If no seal is adopted or used	44
	Power to allow non-manual signatures and facsimile printing of seal	44
	Validity of execution	45
<b>28</b>	<b>Indemnity</b>	<b>45</b>
	Indemnity	45
	Release	46
	Insurance	46
<b>29</b>	<b>Notices</b>	<b>46</b>
	Form of notices	46
	Electronic communications	47
	Persons authorised to give notices	47
	Delivery of written notices	47
	Joint holders	47
	Signatures	47
	Evidence of transmission	48
	Giving notice to a deceased or bankrupt Member	48
	Date of giving notices	48
	Saving provision	49
<b>30</b>	<b>Authentication of Electronic Records</b>	<b>49</b>
	Application of Articles	49
	Authentication of documents sent by Members by Electronic means	49
	Authentication of document sent by the Secretary or Officers of the Company by Electronic means	50
	Manner of signing	50
	Saving provision	50
<b>31</b>	<b>Transfer by way of continuation</b>	<b>51</b>
<b>32</b>	<b>Winding up</b>	<b>51</b>
	Distribution of assets in specie	51
	No obligation to accept liability	52
	The directors are authorised to present a winding up petition	52
<b>33</b>	<b>Amendment of Memorandum and Articles</b>	<b>52</b>
	Power to change name or amend Memorandum	52
	Power to amend these Articles	52

Auth Code: E79632663205

[www.verify.gov.ky](http://www.verify.gov.ky)



**EXEMPTED** Company Registered and  
filed as No. 396482 On 28-Dec-2022



Acting Assistant Registrar

**Companies Act (Revised)**  
**Company Limited by Shares**  
**Articles of Association**  
**of**  
**Prime Number Holding Limited**

**1 Definitions, interpretation and exclusion of Table A**

**Definitions**

1.1 In these Articles, the following definitions apply:

**Act** means the Companies Act (Revised).

**Articles** means, as appropriate:

- (a) these Articles of Association as amended from time to time: or
- (b) two or more particular Articles of these Articles;

and **Article** refers to a particular Article of these Articles.

**Business Day** means a day other than a public holiday in the place where the Company's registered office is located, a Saturday or a Sunday.

**Clear Days**, in relation to a period of notice, means that period excluding:

- (a) the day when the notice is given or deemed to be given; and
- (b) the day for which it is given or on which it is to take effect.

**Company** means the above-named company.

**Default Rate** means 10% (ten per cent) per annum.

**Electronic** has the meaning given to that term in the Electronic Transactions Act (Revised).

**Electronic Record** has the meaning given to that term in the Electronic Transactions Act (Revised).

#VPF:FRQ44386#

Auth Code: E79632663205  
[www.verify.gov.ky](http://www.verify.gov.ky)



**EXEMPTED** Company Registered and  
filed as No. 396482 On 28-Dec-2022



Acting Assistant Registrar

**Electronic Signature** has the meaning given to that term in the Electronic Transactions Act (Revised).

**Fully Paid and Paid Up:**

- (a) in relation to a Share with par value, means that the par value for that Share and any premium payable in respect of the issue of that Share, has been fully paid or credited as paid in money or money's worth;
- (b) in relation to a Share without par value, means that the agreed issue price for that Share has been fully paid or credited as paid in money or money's worth.

**Islands** means the British Overseas Territory of the Cayman Islands.

**Member** means any person or persons entered on the register of members from time to time as the holder of a Share.

**Memorandum** means the Memorandum of Association of the Company as amended from time to time.

**Officer** means a person appointed to hold an office in the Company; and the expression includes a director, alternate director or liquidator, but does not include the Secretary.

**Ordinary Resolution** means a resolution of a duly constituted general meeting of the Company passed by a simple majority of the votes cast by, or on behalf of, the Members entitled to vote. The expression also includes a unanimous written resolution.

**Secretary** means a person appointed to perform the duties of the secretary of the Company, including a joint, assistant or deputy secretary.

**Share** means a share in the share capital of the Company; and the expression:

- (a) includes stock (except where a distinction between shares and stock is expressed or implied); and
- (b) where the context permits, also includes a fraction of a share.

**Special Resolution** has the meaning given to that term in the Act; and the expression includes a unanimous written resolution.

**Treasury Shares** means Shares of the Company held in treasury pursuant to the Act and Article 2.12.

Auth Code: E79632663205  
[www.verify.gov.ky](http://www.verify.gov.ky)



**EXEMPTED** Company Registered and  
filed as No. 396482 On 28-Dec-2022



Acting Assistant Registrar

## Interpretation

1.2 In the interpretation of these Articles, the following provisions apply unless the context otherwise requires:

- (a) A reference in these Articles to a statute is a reference to a statute of the Islands as known by its short title, and includes:
  - (i) any statutory modification, amendment or re-enactment; and
  - (ii) any subordinate legislation or regulations issued under that statute.

Without limitation to the preceding sentence, a reference to a revised Act of the Cayman Islands is taken to be a reference to the revision of that Act in force from time to time as amended from time to time.

- (b) Headings are inserted for convenience only and do not affect the interpretation of these Articles, unless there is ambiguity.
- (c) If a day on which any act, matter or thing is to be done under these Articles is not a Business Day, the act, matter or thing must be done on the next Business Day.
- (d) A word which denotes the singular also denotes the plural, a word which denotes the plural also denotes the singular, and a reference to any gender also denotes the other genders.
- (e) A reference to a **person** includes, as appropriate, a company, trust, partnership, joint venture, association, body corporate or government agency.
- (f) Where a word or phrase is given a defined meaning another part of speech or grammatical form in respect to that word or phrase has a corresponding meaning.
- (g) All references to time are to be calculated by reference to time in the place where the Company's registered office is located.
- (h) The words **written** and **in writing** include all modes of representing or reproducing words in a visible form, but do not include an Electronic Record where the distinction between a document in writing and an Electronic Record is expressed or implied.
- (i) The words **including**, **include** and **in particular** or any similar expression are to be construed without limitation.

Auth Code: E79632663205  
[www.verify.gov.ky](http://www.verify.gov.ky)



**EXEMPTED** Company Registered and  
filed as No. 396482 On 28-Dec-2022



Acting Assistant Registrar

#### **Exclusion of Table A Articles**

1.3 The regulations contained in Table A in the First Schedule of the Act and any other regulations contained in any statute or subordinate legislation are expressly excluded and do not apply to the Company.

#### **2 Shares**

##### **Power to issue Shares and options, with or without special rights**

2.1 Subject to the provisions of the Act and the Articles about the redemption and purchase of the Company's own Shares, the directors have general and unconditional authority to allot (with or without confirming rights of renunciation), grant options over or otherwise deal with any unissued Shares of the Company to such persons, at such times and on such terms and conditions as they may decide. No Share may be issued at a discount except in accordance with the provisions of the Act.

2.2 Without limitation to the preceding Article, the directors may so deal with the unissued Shares of the Company:

- (a) either at a premium or at par;
- (b) with or without preferred, deferred or other special rights or restrictions whether in regard to dividend, voting, return of capital or otherwise.

##### **Power to issue fractions of a Share**

2.3 Subject to the Act, the Company may issue fractions of a Share of any class. A fraction of a Share shall be subject to and carry the corresponding fraction of liabilities (whether with respect to calls or otherwise), limitations, preferences, privileges, qualifications, restrictions, rights and other attributes of a Share of that class of Shares.

##### **Power to pay commissions and brokerage fees**

2.4 The Company may pay a commission to any person in consideration of that person:

- (a) subscribing or agreeing to subscribe, whether absolutely or conditionally; or
- (b) procuring or agreeing to procure subscriptions, whether absolute or conditional

for any Shares in the Company. That commission may be satisfied by the payment of cash or the allotment of Fully Paid or partly-paid Shares or partly in one way and partly in another.

2.5 The Company may employ a broker in the issue of its capital and pay him any proper commission or brokerage.

Auth Code: E79632663205  
[www.verify.gov.ky](http://www.verify.gov.ky)



**EXEMPTED** Company Registered and  
filed as No. 396482 On 28-Dec-2022



Acting Assistant Registrar

#### **Trusts not recognised**

2.6 Except as required by law:

- (a) no person shall be recognised by the Company as holding any Share on any trust; and
- (b) no person other than the Member shall be recognised by the Company as having any right in a Share.

#### **Power to vary class rights**

2.7 If the share capital is divided into different classes of Shares then, unless the terms on which a class of Shares was issued state otherwise, the rights attaching to a class of Shares may only be varied if one of the following applies:

- (a) the Members holding two thirds of the issued Shares of that class consent in writing to the variation; or
- (b) the variation is made with the sanction of a Special Resolution passed at a separate general meeting of the Members holding the issued Shares of that class.

2.8 For the purpose of paragraph (b) of the preceding Article, all the provisions of these Articles relating to general meetings apply, mutatis mutandis, to every such separate meeting except that:

- (a) the necessary quorum shall be one or more persons holding, or representing by proxy, not less than one third of the issued Shares of the class; and
- (b) any Member holding issued Shares of the class, present in person or by proxy or, in the case of a corporate Member, by its duly authorised representative, may demand a poll.

#### **Effect of new Share issue on existing class rights**

2.9 Unless the terms on which a class of Shares was issued state otherwise, the rights conferred on the Member holding Shares of any class shall not be deemed to be varied by the creation or issue of further Shares ranking pari passu with the existing Shares of that class.

Auth Code: E79632663205  
[www.verify.gov.ky](http://www.verify.gov.ky)





**EXEMPTED** Company Registered and  
filed as No. 396482 On 28-Dec-2022



Acting Assistant Registrar

#### **Capital contributions without issue of further Shares**

2.10 With the consent of a Member, the directors may accept a voluntary contribution to the capital of the Company from that Member without issuing Shares in consideration for that contribution. In that event, the contribution shall be dealt with in the following manner:

- (a) It shall be treated as if it were a share premium.
- (b) Unless the Member agrees otherwise:
  - (i) if the Member holds Shares in a single class of Shares - it shall be credited to the share premium account for that class of Shares;
  - (ii) if the Member holds Shares of more than one class - it shall be credited rateably to the share premium accounts for those classes of Shares (in the proportion that the sum of the issue prices for each class of Shares that the Member holds bears to the total issue prices for all classes of Shares that the Member holds).
- (c) It shall be subject to the provisions of the Act and these Articles applicable to share premiums.

#### **No bearer Shares or warrants**

2.11 The Company shall not issue Shares or warrants to bearers.

#### **Treasury Shares**

2.12 Shares that the Company purchases, redeems or acquires by way of surrender in accordance with the Act shall be held as Treasury Shares and not treated as cancelled if:

- (a) the directors so determine prior to the purchase, redemption or surrender of those shares; and
- (b) the relevant provisions of the Memorandum and Articles and the Act are otherwise complied with.

#### **Rights attaching to Treasury Shares and related matters**

2.13 No dividend may be declared or paid, and no other distribution (whether in cash or otherwise) of the Company's assets (including any distribution of assets to members on a winding up) may be made to the Company in respect of a Treasury Share.

2.14 The Company shall be entered in the Register as the holder of the Treasury Shares. However:

- (a) the Company shall not be treated as a member for any purpose and shall not exercise any right in respect of the Treasury Shares, and any purported exercise of such a right shall be void;
- (b) a Treasury Share shall not be voted, directly or indirectly, at any meeting of the Company and shall not be counted in determining the total number of issued shares at any given time, whether for the purposes of these Articles or the Act.

Auth Code: E79632663205  
[www.verify.gov.ky](http://www.verify.gov.ky)



**EXEMPTED** Company Registered and  
filed as No. 396482 On 28-Dec-2022



Acting Assistant Registrar

2.15 Nothing in the preceding Article prevents an allotment of Shares as fully paid bonus shares in respect of a Treasury Share and Shares allotted as fully paid bonus shares in respect of a Treasury Share shall be treated as Treasury Shares.

2.16 Treasury Shares may be disposed of by the Company in accordance with the Act and otherwise on such terms and conditions as the directors determine.

### **3 Share certificates**

#### **Issue of share certificates**

3.1 Upon being entered in the register of members as the holder of a Share, a Member shall be entitled:

- (a) without payment, to one certificate for all the Shares of each class held by that Member (and, upon transferring a part of the Member's holding of Shares of any class, to a certificate for the balance of that holding); and
- (b) upon payment of such reasonable sum as the directors may determine for every certificate after the first, to several certificates each for one or more of that Member's Shares.

3.2 Every certificate shall specify the number, class and distinguishing numbers (if any) of the Shares to which it relates and whether they are Fully Paid or partly paid up. A certificate may be executed under seal or executed in such other manner as the directors determine.

3.3 The Company shall not be bound to issue more than one certificate for Shares held jointly by several persons and delivery of a certificate for a Share to one joint holder shall be a sufficient delivery to all of them.

#### **Renewal of lost or damaged share certificates**

3.4 If a share certificate is defaced, worn-out, lost or destroyed, it may be renewed on such terms (if any) as to:

- (a) evidence;
- (b) indemnity;
- (c) payment of the expenses reasonably incurred by the Company in investigating the evidence; and
- (d) payment of a reasonable fee, if any, for issuing a replacement share certificate

as the directors may determine, and (in the case of defacement or wearing-out) on delivery to the Company of the old certificate.

Auth Code: E79632663205  
[www.verify.gov.ky](http://www.verify.gov.ky)



**EXEMPTED** Company Registered and  
filed as No. 396482 On 28-Dec-2022



Acting Assistant Registrar

#### **4 Lien on Shares**

##### **Nature and scope of lien**

- 4.1 The Company has a first and paramount lien on all Shares (whether Fully Paid or not) registered in the name of a Member (whether solely or jointly with others). The lien is for all moneys payable to the Company by the Member or the Member's estate:
- (a) either alone or jointly with any other person, whether or not that other person is a Member; and
  - (b) whether or not those moneys are presently payable.
- 4.2 At any time the directors may declare any Share to be wholly or partly exempt from the provisions of this Article.

##### **Company may sell Shares to satisfy lien**

- 4.3 The Company may sell any Shares over which it has a lien if all of the following conditions are met:
- (a) the sum in respect of which the lien exists is presently payable;
  - (b) the Company gives notice to the Member holding the Share (or to the person entitled to it in consequence of the death or bankruptcy of that Member) demanding payment and stating that if the notice is not complied with the Shares may be sold; and
  - (c) that sum is not paid within 14 Clear Days after that notice is deemed to be given under these Articles.
- 4.4 The Shares may be sold in such manner as the directors determine.
- 4.5 To the maximum extent permitted by law, the directors shall incur no personal liability to the Member concerned in respect of the sale.

##### **Authority to execute instrument of transfer**

- 4.6 To give effect to a sale, the directors may authorise any person to execute an instrument of transfer of the Shares sold to, or in accordance with the directions of, the purchaser. The title of the transferee of the Shares shall not be affected by any irregularity or invalidity in the proceedings in respect of the sale.

Auth Code: E79632663205  
[www.verify.gov.ky](http://www.verify.gov.ky)



**EXEMPTED** Company Registered and  
filed as No. 396482 On 28-Dec-2022



Acting Assistant Registrar

#### **Consequences of sale of Shares to satisfy lien**

4.7 On sale pursuant to the preceding Articles:

- (a) the name of the Member concerned shall be removed from the register of members as the holder of those Shares; and
- (b) that person shall deliver to the Company for cancellation the certificate for those Shares.

Despite this, that person shall remain liable to the Company for all monies which, at the date of sale, were presently payable by him to the Company in respect of those Shares. That person shall also be liable to pay interest on those monies from the date of sale until payment at the rate at which interest was payable before that sale or, failing that, at the Default Rate. The directors may waive payment wholly or in part or enforce payment without any allowance for the value of the Shares at the time of sale or for any consideration received on their disposal.

#### **Application of proceeds of sale**

4.8 The net proceeds of the sale, after payment of the costs, shall be applied in payment of so much of the sum for which the lien exists as is presently payable. Any residue shall be paid to the person whose Shares have been sold:

- (a) if no certificate for the Shares was issued, at the date of the sale; or
- (b) if a certificate for the Shares was issued, upon surrender to the Company of that certificate for cancellation

but, in either case, subject to the Company retaining a like lien for all sums not presently payable as existed on the Shares before the sale.

#### **5 Calls on Shares and forfeiture**

##### **Power to make calls and effect of calls**

5.1 Subject to the terms of allotment, the directors may make calls on the Members in respect of any moneys unpaid on their Shares including any premium. The call may provide for payment to be by instalments. Subject to receiving at least 14 Clear Days' notice specifying when and where payment is to be made, each Member shall pay to the Company the amount called on his Shares as required by the notice.

Auth Code: E79632663205  
[www.verify.gov.ky](http://www.verify.gov.ky)



**EXEMPTED** Company Registered and  
filed as No. 396482 On 28-Dec-2022



Acting Assistant Registrar

5.2 Before receipt by the Company of any sum due under a call, that call may be revoked in whole or in part and payment of a call may be postponed in whole or in part. Where a call is to be paid in instalments, the Company may revoke the call in respect of all or any remaining instalments in whole or in part and may postpone payment of all or any of the remaining instalments in whole or in part.

5.3 A Member on whom a call is made shall remain liable for that call notwithstanding the subsequent transfer of the Shares in respect of which the call was made. He shall not be liable for calls made after he is no longer registered as Member in respect of those Shares.

#### **Time when call made**

5.4 A call shall be deemed to have been made at the time when the resolution of the directors authorising the call was passed.

#### **Liability of joint holders**

5.5 Members registered as the joint holders of a Share shall be jointly and severally liable to pay all calls in respect of the Share.

#### **Interest on unpaid calls**

5.6 If a call remains unpaid after it has become due and payable the person from whom it is due and payable shall pay interest on the amount unpaid from the day it became due and payable until it is paid:

(a) at the rate fixed by the terms of allotment of the Share or in the notice of the call; or

(b) if no rate is fixed, at the Default Rate.

The directors may waive payment of the interest wholly or in part.

#### **Deemed calls**

5.7 Any amount payable in respect of a Share, whether on allotment or on a fixed date or otherwise, shall be deemed to be payable as a call. If the amount is not paid when due the provisions of these Articles shall apply as if the amount had become due and payable by virtue of a call.

#### **Power to accept early payment**

5.8 The Company may accept from a Member the whole or a part of the amount remaining unpaid on Shares held by him although no part of that amount has been called up.

Auth Code: E79632663205  
[www.verify.gov.ky](http://www.verify.gov.ky)



**EXEMPTED** Company Registered and  
filed as No. 396482 On 28-Dec-2022



Acting Assistant Registrar

**Power to make different arrangements at time of issue of Shares**

5.9 Subject to the terms of allotment, the directors may make arrangements on the issue of Shares to distinguish between Members in the amounts and times of payment of calls on their Shares.

**Notice of default**

5.10 If a call remains unpaid after it has become due and payable the directors may give to the person from whom it is due not less than 14 Clear Days' notice requiring payment of:

- (a) the amount unpaid;
- (b) any interest which may have accrued;
- (c) any expenses which have been incurred by the Company due to that person's default.

5.11 The notice shall state the following:

- (a) the place where payment is to be made; and
- (b) a warning that if the notice is not complied with the Shares in respect of which the call is made will be liable to be forfeited.

**Forfeiture or surrender of Shares**

5.12 If the notice under the preceding Article is not complied with, the directors may, before the payment required by the notice has been received, resolve that any Share the subject of that notice be forfeited. The forfeiture shall include all dividends or other moneys payable in respect of the forfeited Share and not paid before the forfeiture. Despite the foregoing, the directors may determine that any Share the subject of that notice be accepted by the Company as surrendered by the Member holding that Share in lieu of forfeiture.

**Disposal of forfeited or surrendered Share and power to cancel forfeiture or surrender**

5.13 A forfeited or surrendered Share may be sold, re-allotted or otherwise disposed of on such terms and in such manner as the directors determine either to the former Member who held that Share or to any other person. The forfeiture or surrender may be cancelled on such terms as the directors think fit at any time before a sale, re-allotment or other disposition. Where, for the purposes of its disposal, a forfeited or surrendered Share is to be transferred to any person, the directors may authorise some person to execute an instrument of transfer of the Share to the transferee.

Auth Code: E79632663205  
[www.verify.gov.ky](http://www.verify.gov.ky)



**EXEMPTED** Company Registered and  
filed as No. 396482 On 28-Dec-2022



Acting Assistant Registrar

#### **Effect of forfeiture or surrender on former Member**

5.14 On forfeiture or surrender:

- (a) the name of the Member concerned shall be removed from the register of members as the holder of those Shares and that person shall cease to be a Member in respect of those Shares; and
- (b) that person shall surrender to the Company for cancellation the certificate (if any) for the forfeited or surrendered Shares.

5.15 Despite the forfeiture or surrender of his Shares, that person shall remain liable to the Company for all moneys which at the date of forfeiture or surrender were presently payable by him to the Company in respect of those Shares together with:

- (a) all expenses; and
- (b) interest from the date of forfeiture or surrender until payment:
  - (i) at the rate of which interest was payable on those moneys before forfeiture; or
  - (ii) if no interest was so payable, at the Default Rate.

The directors, however, may waive payment wholly or in part.

#### **Evidence of forfeiture or surrender**

5.16 A declaration, whether statutory or under oath, made by a director or the Secretary shall be conclusive evidence of the following matters stated in it as against all persons claiming to be entitled to forfeited Shares:

- (a) that the person making the declaration is a director or Secretary of the Company, and
- (b) that the particular Shares have been forfeited or surrendered on a particular date.

Subject to the execution of an instrument of transfer, if necessary, the declaration shall constitute good title to the Shares.

#### **Sale of forfeited or surrendered Shares**

5.17 Any person to whom the forfeited or surrendered Shares are disposed of shall not be bound to see to the application of the consideration, if any, of those Shares nor shall his title to the Shares be affected by any irregularity in, or invalidity of the proceedings in respect of, the forfeiture, surrender or disposal of those Shares.

Auth Code: E79632663205

[www.verify.gov.ky](http://www.verify.gov.ky)



**EXEMPTED** Company Registered and  
filed as No. 396482 On 28-Dec-2022



Acting Assistant Registrar

## 6 Transfer of Shares

### Form of transfer

- 6.1 Subject to the following Articles about the transfer of Shares, a Member may transfer Shares to another person by completing an instrument of transfer, in a common form or in a form approved by the directors, executed:
- (a) where the Shares are Fully Paid, by or on behalf of that Member; and
  - (b) where the Shares are partly paid, by or on behalf of that Member and the transferee.

### Power to refuse registration

- 6.2 The directors may refuse to register the transfer of a Share to any person. They may do so in their absolute discretion, without giving any reason for their refusal, and irrespective of whether the Share is Fully Paid or the Company has no lien over it.

### Notice of refusal to register

- 6.3 If the directors refuse to register a transfer of a Share, they must send notice of their refusal to the existing Member within two months after the date on which the transfer was lodged with the Company.

### Power to suspend registration

- 6.4 The directors may suspend registration of the transfer of Shares at such times and for such periods, not exceeding 30 days in any calendar year, as they determine.

### Fee, if any, payable for registration

- 6.5 If the directors so decide, the Company may charge a reasonable fee for the registration of any instrument of transfer or other document relating to the title to a Share.

### Company may retain instrument of transfer

- 6.6 The Company shall be entitled to retain any instrument of transfer which is registered; but an instrument of transfer which the directors refuse to register shall be returned to the person lodging it when notice of the refusal is given.

## 7 Transmission of Shares

### Persons entitled on death of a Member

- 7.1 If a Member dies, the only persons recognised by the Company as having any title to the deceased Members' interest are the following:
- (a) where the deceased Member was a joint holder, the survivor or survivors; and
  - (b) where the deceased Member was a sole holder, that Member's personal representative or representatives.

Auth Code: E79632663205  
[www.verify.gov.ky](http://www.verify.gov.ky)





**EXEMPTED** Company Registered and  
filed as No. 396482 On 28-Dec-2022



Acting Assistant Registrar

7.2 Nothing in these Articles shall release the deceased Member's estate from any liability in respect of any Share, whether the deceased was a sole holder or a joint holder.

**Registration of transfer of a Share following death or bankruptcy**

7.3 A person becoming entitled to a Share in consequence of the death or bankruptcy of a Member may elect to do either of the following:

- (a) to become the holder of the Share; or
- (b) to transfer the Share to another person.

7.4 That person must produce such evidence of his entitlement as the directors may properly require.

7.5 If the person elects to become the holder of the Share, he must give notice to the Company to that effect. For the purposes of these Articles, that notice shall be treated as though it were an executed instrument of transfer.

7.6 If the person elects to transfer the Share to another person then:

- (a) if the Share is Fully Paid, the transferor must execute an instrument of transfer; and
- (b) if the Share is partly paid, the transferor and the transferee must execute an instrument of transfer.

7.7 All the Articles relating to the transfer of Shares shall apply to the notice or, as appropriate, the instrument of transfer.

**Indemnity**

7.8 A person registered as a Member by reason of the death or bankruptcy of another Member shall indemnify the Company and the directors against any loss or damage suffered by the Company or the directors as a result of that registration.

**Rights of person entitled to a Share following death or bankruptcy**

7.9 A person becoming entitled to a Share by reason of the death or bankruptcy of a Member shall have the rights to which he would be entitled if he were registered as the holder of the Share. But, until he is registered as Member in respect of the Share, he shall not be entitled to attend or vote at any meeting of the Company or at any separate meeting of the holders of that class of Shares in the Company.

Auth Code: E79632663205  
[www.verify.gov.ky](http://www.verify.gov.ky)



**EXEMPTED** Company Registered and  
filed as No. 396482 On 28-Dec-2022



Acting Assistant Registrar

## 8 Alteration of capital

### Increasing, consolidating, converting, dividing and cancelling share capital

- 8.1 To the fullest extent permitted by the Act, the Company may by Ordinary Resolution do any of the following and amend its Memorandum for that purpose:
- (a) increase its share capital by new Shares of the amount fixed by that Ordinary Resolution and with the attached rights, priorities and privileges set out in that Ordinary Resolution;
  - (b) consolidate and divide all or any of its share capital into Shares of larger amount than its existing Shares;
  - (c) convert all or any of its Paid Up Shares into stock, and reconvert that stock into Paid Up Shares of any denomination;
  - (d) sub-divide its Shares or any of them into Shares of an amount smaller than that fixed by the Memorandum, so, however, that in the sub-division, the proportion between the amount paid and the amount, if any, unpaid on each reduced Share shall be the same as it was in case of the Share from which the reduced Share is derived; and
  - (e) cancel Shares which, at the date of the passing of that Ordinary Resolution, have not been taken or agreed to be taken by any person, and diminish the amount of its share capital by the amount of the Shares so cancelled or, in the case of Shares without nominal par value, diminish the number of Shares into which its capital is divided.

### Dealing with fractions resulting from consolidation of Shares

- 8.2 Whenever, as a result of a consolidation of Shares, any Members would become entitled to fractions of a Share the directors may on behalf of those Members:
- (a) sell the Shares representing the fractions for the best price reasonably obtainable to any person (including, subject to the provisions of the Act, the Company); and
  - (b) distribute the net proceeds in due proportion among those Members.

For that purpose, the directors may authorise some person to execute an instrument of transfer of the Shares to, or in accordance with the directions of, the purchaser. The transferee shall not be bound to see to the application of the purchase money nor shall the transferee's title to the Shares be affected by any irregularity in, or invalidity of, the proceedings in respect of the sale.

Auth Code: E79632663205  
[www.verify.gov.ky](http://www.verify.gov.ky)



**EXEMPTED** Company Registered and  
filed as No. 396482 On 28-Dec-2022



Acting Assistant Registrar

### **Reducing share capital**

8.3 Subject to the Act and to any rights for the time being conferred on the Members holding a particular class of Shares, the Company may, by Special Resolution, reduce its share capital in any way.

### **9 Redemption and purchase of own Shares**

#### **Power to issue redeemable Shares and to purchase own Shares**

9.1 Subject to the Act, and to any rights for the time being conferred on the Members holding a particular class of Shares, the Company may by its directors:

- (a) issue Shares that are to be redeemed or liable to be redeemed, at the option of the Company or the Member holding those redeemable Shares, on the terms and in the manner its directors determine before the issue of those Shares;
- (b) with the consent by Special Resolution of the Members holding Shares of a particular class, vary the rights attaching to that class of Shares so as to provide that those Shares are to be redeemed or are liable to be redeemed at the option of the Company on the terms and in the manner which the directors determine at the time of such variation; and
- (c) purchase all or any of its own Shares of any class including any redeemable Shares on the terms and in the manner which the directors determine at the time of such purchase.

The Company may make a payment in respect of the redemption or purchase of its own Shares in any manner authorised by the Act, including out of any combination of the following: capital, its profits and the proceeds of a fresh issue of Shares.

#### **Power to pay for redemption or purchase in cash or in specie**

9.2 When making a payment in respect of the redemption or purchase of Shares, the directors may make the payment in cash or in specie (or partly in one and partly in the other) if so authorised by the terms of the allotment of those Shares, or by the terms applying to those Shares in accordance with Article 9.1, or otherwise by agreement with the Member holding those Shares.

Auth Code: E79632663205  
[www.verify.gov.ky](http://www.verify.gov.ky)



**EXEMPTED** Company Registered and  
filed as No. 396482 On 28-Dec-2022



Acting Assistant Registrar

### **Effect of redemption or purchase of a Share**

9.3 Upon the date of redemption or purchase of a Share:

- (a) the Member holding that Share shall cease to be entitled to any rights in respect of the Share other than the right to receive:
  - (i) the price for the Share; and
  - (ii) any dividend declared in respect of the Share prior to the date of redemption or purchase;
- (b) the Member's name shall be removed from the register of members with respect to the Share; and
- (c) the Share shall be cancelled or held as a Treasury Shares, as the directors may determine.

For the purpose of this Article, the date of redemption or purchase is the date when the redemption or purchase falls due.

### **10 Meetings of Members**

#### **Power to call meetings**

10.1 The directors may call a general meeting at any time.

10.2 If there are insufficient directors to constitute a quorum and the remaining directors are unable to agree on the appointment of additional directors, the directors must call a general meeting for the purpose of appointing additional directors.

10.3 The directors must also call a general meeting if requisitioned in the manner set out in the next two Articles.

10.4 The requisition must be in writing and given by one or more Members who together hold at least 10% of the rights to vote at such general meeting.

10.5 The requisition must also:

- (a) specify the purpose of the meeting.
- (b) be signed by or on behalf of each requisitioner (and for this purpose each joint holder shall be obliged to sign). The requisition may consist of several documents in like form signed by one or more of the requisitioners.
- (c) be delivered in accordance with the notice provisions.

10.6 Should the directors fail to call a general meeting within 21 Clear Days from the date of receipt of a requisition, the requisitioners or any of them may call a general meeting within three months after the end of that period.

Auth Code: E79632663205  
[www.verify.gov.ky](http://www.verify.gov.ky)



**EXEMPTED** Company Registered and  
filed as No. 396482 On 28-Dec-2022



Acting Assistant Registrar

10.7 Without limitation to the foregoing, if there are insufficient directors to constitute a quorum and the remaining directors are unable to agree on the appointment of additional directors, any one or more Members who together hold at least 10% of the rights to vote at a general meeting may call a general meeting for the purpose of considering the business specified in the notice of meeting which shall include as an item of business the appointment of additional directors.

10.8 If the Members call a meeting under the above provisions, the Company shall reimburse their reasonable expenses.

**Content of notice**

10.9 Notice of a general meeting shall specify each of the following:

- (a) the place, the date and the hour of the meeting;
- (b) if the meeting is to be held in two or more places, the technology that will be used to facilitate the meeting;
- (c) subject to paragraph (d), the general nature of the business to be transacted; and
- (d) if a resolution is proposed as a Special Resolution, the text of that resolution.

10.10 In each notice there shall appear with reasonable prominence the following statements:

- (a) that a Member who is entitled to attend and vote is entitled to appoint one or more proxies to attend and vote instead of that Member; and
- (b) that a proxyholder need not be a Member.

**Period of notice**

10.11 At least five Clear Days' notice of a general meeting must be given to Members. But a meeting may be convened on shorter notice with the consent of the Member or Members who, individually or collectively, hold at least 90% of the voting rights of all those who have a right to vote at that meeting.

**Persons entitled to receive notice**

10.12 Subject to the provisions of these Articles and to any restrictions imposed on any Shares, the notice shall be given to the following people:

- (a) the Members;
- (b) persons entitled to a Share in consequence of the death or bankruptcy of a Member; and
- (c) the directors.

Auth Code: E79632663205  
[www.verify.gov.ky](http://www.verify.gov.ky)



**EXEMPTED** Company Registered and  
filed as No. 396482 On 28-Dec-2022



Acting Assistant Registrar

**Publication of notice on a website**

10.13 Subject to the Act, a notice of a general meeting may be published on a website providing the recipient is given separate notice of:

- (a) the publication of the notice on the website;
- (b) the place on the website where the notice may be accessed;
- (c) how it may be accessed; and
- (d) the place, date and time of the general meeting.

10.14 If a Member notifies the Company that he is unable for any reason to access the website, the Company must as soon as practicable give notice of the meeting to that Member by any other means permitted by these Articles. But this will not affect when that Member is deemed to have received notice of the meeting.

**Time a website notice is deemed to be given**

10.15 A website notice is deemed to be given when the Member is given notice of its publication.

**Required duration of publication on a website**

10.16 Where the notice of meeting is published on a website, it shall continue to be published in the same place on that website from the date of the notification until the conclusion of the meeting to which the notice relates.

**Accidental omission to give notice or non-receipt of notice**

10.17 Proceedings at a meeting shall not be invalidated by the following:

- (a) an accidental failure to give notice of the meeting to any person entitled to notice; or
- (b) non-receipt of notice of the meeting by any person entitled to notice.

10.18 In addition, where a notice of meeting is published on a website, proceedings at the meeting shall not be invalidated merely because it is accidentally published:

- (a) in a different place on the website; or
- (b) for part only of the period from the date of the notification until the conclusion of the meeting to which the notice relates.

Auth Code: E79632663205

[www.verify.gov.ky](http://www.verify.gov.ky)



**EXEMPTED** Company Registered and  
filed as No. 396482 On 28-Dec-2022



Acting Assistant Registrar

## 11 Proceedings at meetings of Members

### Quorum

- 11.1 Save as provided in the following Article, no business shall be transacted at any meeting unless a quorum is present in person or by proxy. A quorum is as follows:
- (a) if the Company has only one Member: that Member;
  - (b) if the Company has more than one Member: two Members.

### Lack of quorum

- 11.2 If a quorum is not present within 15 minutes of the time appointed for the meeting, or if at any time during the meeting it becomes inquorate, then the following provisions apply:
- (a) If the meeting was requisitioned by Members, it shall be cancelled.
  - (b) In any other case, the meeting shall stand adjourned to the same time and place seven days hence, or to such other time or place as is determined by the directors. If a quorum is not present within 15 minutes of the time appointed for the adjourned meeting, then the Members present in person or by proxy shall constitute a quorum.

### Use of technology

- 11.3 A person may participate in a general meeting through the medium of conference telephone, video or any other form of communications equipment providing all persons participating in the meeting are able to hear and speak to each other throughout the meeting. A person participating in this way is deemed to be present in person at the meeting.

### Chairman

- 11.4 The chairman of a general meeting shall be the chairman of the board or such other director as the directors have nominated to chair board meetings in the absence of the chairman of the board. Absent any such person being present within 15 minutes of the time appointed for the meeting, the directors present shall elect one of their number to chair the meeting.
- 11.5 If no director is present within 15 minutes of the time appointed for the meeting, or if no director is willing to act as chairman, the Members present in person or by proxy and entitled to vote shall choose one of their number to chair the meeting.

Auth Code: E79632663205  
[www.verify.gov.ky](http://www.verify.gov.ky)



**EXEMPTED** Company Registered and  
filed as No. 396482 On 28-Dec-2022



Acting Assistant Registrar

#### **Right of a director to attend and speak**

- 11.6 Even if a director is not a Member, he shall be entitled to attend and speak at any general meeting and at any separate meeting of Members holding a particular class of Shares in the Company.

#### **Adjournment**

- 11.7 The chairman may at any time adjourn a meeting with the consent of the Members constituting a quorum. The chairman must adjourn the meeting if so directed by the meeting. No business, however, can be transacted at an adjourned meeting other than business which might properly have been transacted at the original meeting.
- 11.8 Should a meeting be adjourned for more than seven Clear Days, whether because of a lack of quorum or otherwise, Members shall be given at least seven Clear Days' notice of the date, time and place of the adjourned meeting and the general nature of the business to be transacted. Otherwise it shall not be necessary to give any notice of the adjournment.

#### **Method of voting**

- 11.9 A resolution put to the vote of the meeting shall be decided on a show of hands unless before, or on the declaration of the result of the show of hands, a poll is duly demanded. A poll may be demanded:
- (a) by the chairman; or
  - (b) by any Member or Members present who, individually or collectively, hold at least 10% of the voting rights of all those who have a right to vote on the resolution.

#### **Outcome of vote by show of hands**

- 11.10 Unless a poll is duly demanded, a declaration by the chairman as to the result of a resolution and an entry to that effect in the minutes of the meeting shall be conclusive evidence of the outcome of a show of hands without proof of the number or proportion of the votes recorded in favour of or against the resolution.

#### **Withdrawal of demand for a poll**

- 11.11 The demand for a poll may be withdrawn before the poll is taken, but only with the consent of the chairman. The chairman shall announce any such withdrawal to the meeting and, unless another person forthwith demands a poll, any earlier show of hands on that resolution shall be treated as the vote on that resolution; if there has been no earlier show of hands, then the resolution shall be put to the vote of the meeting.

Auth Code: E79632663205  
[www.verify.gov.ky](http://www.verify.gov.ky)





**EXEMPTED** Company Registered and  
filed as No. 396482 On 28-Dec-2022



Acting Assistant Registrar

#### **Taking of a poll**

- 11.12 A poll demanded on the question of adjournment shall be taken immediately.
- 11.13 A poll demanded on any other question shall be taken either immediately or at an adjourned meeting at such time and place as the chairman directs, not being more than 30 Clear Days after the poll was demanded.
- 11.14 The demand for a poll shall not prevent the meeting continuing to transact any business other than the question on which the poll was demanded.
- 11.15 A poll shall be taken in such manner as the chairman directs. He may appoint scrutineers (who need not be Members) and fix a place and time for declaring the result of the poll. If, through the aid of technology, the meeting is held in more than place, the chairman may appoint scrutineers in more than place; but if he considers that the poll cannot be effectively monitored at that meeting, the chairman shall adjourn the holding of the poll to a date, place and time when that can occur.

#### **Chairman's casting vote**

- 11.16 If the votes on a resolution, whether on a show of hands or on a poll, are equal the chairman may if he wishes exercise a casting vote.

#### **Amendments to resolutions**

- 11.17 An Ordinary Resolution to be proposed at a general meeting may be amended by Ordinary Resolution if:
- (a) not less than 48 hours before the meeting is to take place (or such later time as the chairman of the meeting may determine), notice of the proposed amendment is given to the Company in writing by a Member entitled to vote at that meeting; and
  - (b) the proposed amendment does not, in the reasonable opinion of the chairman of the meeting, materially alter the scope of the resolution.
- 11.18 A Special Resolution to be proposed at a general meeting may be amended by Ordinary Resolution, if:
- (a) the chairman of the meeting proposes the amendment at the general meeting at which the resolution is to be proposed, and
  - (b) the amendment does not go beyond what the chairman considers is necessary to correct a grammatical or other non-substantive error in the resolution.

Auth Code: E79632663205  
[www.verify.gov.ky](http://www.verify.gov.ky)



**EXEMPTED** Company Registered and  
filed as No. 396482 On 28-Dec-2022



Acting Assistant Registrar

- 11.19 If the chairman of the meeting, acting in good faith, wrongly decides that an amendment to a resolution is out of order, the chairman's error does not invalidate the vote on that resolution.

**Written resolutions**

- 11.20 Members may pass a resolution in writing without holding a meeting if the following conditions are met:

- (a) all Members entitled to vote are given notice of the resolution as if the same were being proposed at a meeting of Members;
- (b) all Members entitled so to vote :
  - (i) sign a document; or
  - (ii) sign several documents in the like form each signed by one or more of those Members; and
- (c) the signed document or documents is or are delivered to the Company, including, if the Company so nominates, by delivery of an Electronic Record by Electronic means to the address specified for that purpose.

Such written resolution shall be as effective as if it had been passed at a meeting of the Members entitled to vote duly convened and held.

- 11.21 If a written resolution is described as a Special Resolution or as an Ordinary Resolution, it has effect accordingly.

- 11.22 The directors may determine the manner in which written resolutions shall be put to Members. In particular, they may provide, in the form of any written resolution, for each Member to indicate, out of the number of votes the Member would have been entitled to cast at a meeting to consider the resolution, how many votes he wishes to cast in favour of the resolution and how many against the resolution or to be treated as abstentions. The result of any such written resolution shall be determined on the same basis as on a poll.

**Sole-member company**

- 11.23 If the Company has only one Member, and the Member records in writing his decision on a question, that record shall constitute both the passing of a resolution and the minute of it.

Auth Code: E79632663205  
[www.verify.gov.ky](http://www.verify.gov.ky)



**EXEMPTED** Company Registered and  
filed as No. 396482 On 28-Dec-2022



Acting Assistant Registrar

## 12 Voting rights of Members

### Right to vote

- 12.1 Unless their Shares carry no right to vote, or unless a call or other amount presently payable has not been paid, all Members are entitled to vote at a general meeting, whether on a show of hands or on a poll, and all Members holding Shares of a particular class of Shares are entitled to vote at a meeting of the holders of that class of Shares.
- 12.2 Members may vote in person or by proxy.
- 12.3 On a show of hands, every Member shall have one vote. For the avoidance of doubt, an individual who represents two or more Members, including a Member in that individual's own right, that individual shall be entitled to a separate vote for each Member.
- 12.4 On a poll a Member shall have one vote for each Share he holds, unless any Share carries special voting rights.
- 12.5 A fraction of a Share shall entitle its holder to an equivalent fraction of one vote.
- 12.6 No Member is bound to vote on his Shares or any of them; nor is he bound to vote each of his Shares in the same way.

### Rights of joint holders

- 12.7 If Shares are held jointly, only one of the joint holders may vote. If more than one of the joint holders tenders a vote, the vote of the holder whose name in respect of those Shares appears first in the register of members shall be accepted to the exclusion of the votes of the other joint holder.

### Representation of corporate Members

- 12.8 Save where otherwise provided, a corporate Member must act by a duly authorised representative.
- 12.9 A corporate Member wishing to act by a duly authorised representative must identify that person to the Company by notice in writing.
- 12.10 The authorisation may be for any period of time, and must be delivered to the Company not less than two hours before the commencement of the meeting at which it is first used.
- 12.11 The directors of the Company may require the production of any evidence which they consider necessary to determine the validity of the notice.

Auth Code: E79632663205  
[www.verify.gov.ky](http://www.verify.gov.ky)



**EXEMPTED** Company Registered and  
filed as No. 396482 On 28-Dec-2022



Acting Assistant Registrar

- 12.12 Where a duly authorised representative is present at a meeting that Member is deemed to be present in person; and the acts of the duly authorised representative are personal acts of that Member.
- 12.13 A corporate Member may revoke the appointment of a duly authorised representative at any time by notice to the Company; but such revocation will not affect the validity of any acts carried out by the duly authorised representative before the directors of the Company had actual notice of the revocation.

#### **Member with mental disorder**

- 12.14 A Member in respect of whom an order has been made by any court having jurisdiction (whether in the Islands or elsewhere) in matters concerning mental disorder may vote, whether on a show of hands or on a poll, by that Member's receiver, curator bonis or other person authorised in that behalf appointed by that court.
- 12.15 For the purpose of the preceding Article, evidence to the satisfaction of the directors of the authority of the person claiming to exercise the right to vote must be received not less than 24 hours before holding the relevant meeting or the adjourned meeting in any manner specified for the delivery of forms of appointment of a proxy, whether in writing or by Electronic means. In default, the right to vote shall not be exercisable.

#### **Objections to admissibility of votes**

- 12.16 An objection to the validity of a person's vote may only be raised at the meeting or at the adjourned meeting at which the vote is sought to be tendered. Any objection duly made shall be referred to the chairman whose decision shall be final and conclusive.

#### **Form of proxy**

- 12.17 An instrument appointing a proxy shall be in any common form or in any other form approved by the directors.
- 12.18 The instrument must be in writing and signed in one of the following ways:
- (a) by the Member; or
  - (b) by the Member's authorised attorney; or
  - (c) if the Member is a corporation or other body corporate, under seal or signed by an authorised officer, secretary or attorney.

If the directors so resolve, the Company may accept an Electronic Record of that instrument delivered in the manner specified below and otherwise satisfying the Articles about authentication of Electronic Records.

Auth Code: E79632663205  
[www.verify.gov.ky](http://www.verify.gov.ky)



**EXEMPTED** Company Registered and  
filed as No. 396482 On 28-Dec-2022



Acting Assistant Registrar

- 12.19 The directors may require the production of any evidence which they consider necessary to determine the validity of any appointment of a proxy.
- 12.20 A Member may revoke the appointment of a proxy at any time by notice to the Company duly signed in accordance with the Article above about signing proxies; but such revocation will not affect the validity of any acts carried out by the proxy before the directors of the Company had actual notice of the revocation.

**How and when proxy is to be delivered**

- 12.21 Subject to the following Articles, the form of appointment of a proxy and any authority under which it is signed (or a copy of the authority certified notarially or in any other way approved by the directors) must be delivered so that it is received by the Company at any time before the time for holding the meeting or adjourned meeting at which the person named in the form of appointment of proxy proposes to vote. They must be delivered in either of the following ways:
- (a) In the case of an instrument in writing, it must be left at or sent by post:
    - (i) to the registered office of the Company; or
    - (ii) to such other place within the Islands specified in the notice convening the meeting or in any form of appointment of proxy sent out by the Company in relation to the meeting.
  - (b) If, pursuant to the notice provisions, a notice may be given to the Company in an Electronic Record, an Electronic Record of an appointment of a proxy must be sent to the address specified pursuant to those provisions unless another address for that purpose is specified:
    - (i) in the notice convening the meeting; or
    - (ii) in any form of appointment of a proxy sent out by the Company in relation to the meeting; or
    - (iii) in any invitation to appoint a proxy issued by the Company in relation to the meeting.
- 12.22 Where a poll is taken:
- (a) if it is taken more than seven Clear Days after it is demanded, the form of appointment of a proxy and any accompanying authority (or an Electronic Record of the same) must be delivered as required under the preceding Article not less than 24 hours before the time appointed for the taking of the poll;

Auth Code: E79632663205  
[www.verify.gov.ky](http://www.verify.gov.ky)



**EXEMPTED** Company Registered and  
filed as No. 396482 On 28-Dec-2022



Acting Assistant Registrar

- (b) but if it to be taken within seven Clear Days after it was demanded, the form of appointment of a proxy and any accompanying authority (or an Electronic Record of the same) must be e delivered as required under the preceding Article not less than two hours before the time appointed for the taking of the poll.

12.23 If the form of appointment of proxy is not delivered on time, it is invalid.

#### **Voting by proxy**

12.24 A proxy shall have the same voting rights at a meeting or adjourned meeting as the Member would have had except to the extent that the instrument appointing him limits those rights. Notwithstanding the appointment of a proxy, a Member may attend and vote at a meeting or adjourned meeting. If a Member votes on any resolution a vote by his proxy on the same resolution, unless in respect of different Shares, shall be invalid.

#### **13 Number of directors**

Unless otherwise determined by Ordinary Resolution, the minimum number of directors shall be one and the maximum number shall be ten. There shall be no directors, however, until the first director is or the first directors are appointed by the subscriber or subscribers to the Memorandum.

#### **14 Appointment, disqualification and removal of directors**

##### **First directors**

14.1 The first directors shall be appointed in writing by the subscriber or subscribers to the Memorandum.

##### **No age limit**

14.2 There is no age limit for directors save that they must be aged at least 18 years.

##### **Corporate directors**

14.3 Unless prohibited by law, a body corporate may be a director. If a body corporate is a director, the Articles about representation of corporate Members at general meetings apply, mutatis mutandis, to the Articles about directors' meetings.

##### **No shareholding qualification**

14.4 Unless a shareholding qualification for directors is fixed by Ordinary Resolution, no director shall be required to own Shares as a condition of his appointment.

Auth Code: E79632663205  
[www.verify.gov.ky](http://www.verify.gov.ky)



**EXEMPTED** Company Registered and  
filed as No. 396482 On 28-Dec-2022



Acting Assistant Registrar

#### **Appointment of directors**

- 14.5 A director may be appointed by Ordinary Resolution or by the directors. Any appointment may be to fill a vacancy or as an additional director.
- 14.6 Notwithstanding the other provisions of these Articles, in any case where, as a result of death, the Company has no directors and no shareholders, the personal representatives of the last shareholder to have died have the power, by notice in writing to the Company, to appoint a person to be a director. For the purpose of this Article:
- (a) where two or more shareholders die in circumstances rendering it uncertain who was the last to die, a younger shareholder is deemed to have survived an older shareholder;
  - (b) if the last shareholder died leaving a will which disposes of that shareholder's shares in the Company (whether by way of specific gift, as part of the residuary estate, or otherwise):
    - (i) the expression personal representatives of the last shareholder means:
      - (A) until a grant of probate in respect of that will has been obtained from the Grand Court of the Cayman Islands, all of the executors named in that will who are living at the time the power of appointment under this Article is exercised; and
      - (B) after such grant of probate has been obtained, only such of those executors who have proved that will;
    - (ii) without derogating from section 3(1) of the Succession Act (Revised), the executors named in that will may exercise the power of appointment under this Article without first obtaining a grant of probate.
- 14.7 A remaining director may appoint a director even though there is not a quorum of directors.
- 14.8 No appointment can cause the number of directors to exceed the maximum; and any such appointment shall be invalid.

#### **Removal of directors**

- 14.9 A director may be removed by Ordinary Resolution.

#### **Resignation of directors**

- 14.10 A director may at any time resign office by giving to the Company notice in writing or, if permitted pursuant to the notice provisions, in an Electronic Record delivered in either case in accordance with those provisions.

Auth Code: E79632663205  
[www.verify.gov.ky](http://www.verify.gov.ky)



**EXEMPTED** Company Registered and  
filed as No. 396482 On 28-Dec-2022



Acting Assistant Registrar

14.11 Unless the notice specifies a different date, the director shall be deemed to have resigned on the date that the notice is delivered to the Company.

#### **Termination of the office of director**

14.12 A director's office shall be terminated forthwith if:

- (a) he is prohibited by the law of the Islands from acting as a director; or
- (b) he is made bankrupt or makes an arrangement or composition with his creditors generally; or
- (c) in the opinion of a registered medical practitioner by whom he is being treated he becomes physically or mentally incapable of acting as a director; or
- (d) he is made subject to any law relating to mental health or incompetence, whether by court order or otherwise; or
- (e) without the consent of the other directors, he is absent from meetings of directors for a continuous period of six months.

#### **15 Alternate directors**

##### **Appointment and removal**

15.1 Any director may appoint any other person, including another director, to act in his place as an alternate director. No appointment shall take effect until the director has given notice of the appointment to the other directors. Such notice must be given to each other director by either of the following methods:

- (a) by notice in writing in accordance with the notice provisions;
- (b) if the other director has an email address, by emailing to that address a scanned copy of the notice as a PDF attachment (the PDF version being deemed to be the notice unless Article 30.7 applies), in which event notice shall be taken to be given on the date of receipt by the recipient in readable form. For the avoidance of doubt, the same email may be sent to the email address of more than one director (and to the email address of the Company pursuant to Article 15.4(c)).

15.2 Without limitation to the preceding Article, a director may appoint an alternate for a particular meeting by sending an email to his fellow directors informing them that they are to take such email as notice of such appointment for such meeting. Such appointment shall be effective without the need for a signed notice of appointment or the giving of notice to the Company in accordance with Article 15.4.

Auth Code: E79632663205  
[www.verify.gov.ky](http://www.verify.gov.ky)





**EXEMPTED** Company Registered and  
filed as No. 396482 On 28-Dec-2022



Acting Assistant Registrar

- 15.3 A director may revoke his appointment of an alternate at any time. No revocation shall take effect until the director has given notice of the revocation to the other directors. Such notice must be given by either of the methods specified in Article 15.1.
- 15.4 A notice of appointment or removal of an alternate director must also be given to the Company by any of the following methods:
- (a) by notice in writing in accordance with the notice provisions;
  - (b) if the Company has a facsimile address for the time being, by sending by facsimile transmission to that facsimile address a facsimile copy or, otherwise, by sending by facsimile transmission to the facsimile address of the Company's registered office a facsimile copy (in either case, the facsimile copy being deemed to be the notice unless Article 30.7 applies), in which event notice shall be taken to be given on the date of an error-free transmission report from the sender's fax machine;
  - (c) if the Company has an email address for the time being, by emailing to that email address a scanned copy of the notice as a PDF attachment or, otherwise, by emailing to the email address provided by the Company's registered office a scanned copy of the notice as a PDF attachment (in either case, the PDF version being deemed to be the notice unless Article 30.7 applies), in which event notice shall be taken to be given on the date of receipt by the Company or the Company's registered office (as appropriate) in readable form; or
  - (d) if permitted pursuant to the notice provisions, in some other form of approved Electronic Record delivered in accordance with those provisions in writing.

#### Notices

- 15.5 All notices of meetings of directors shall continue to be given to the appointing director and not to the alternate.

#### Rights of alternate director

- 15.6 An alternate director shall be entitled to attend and vote at any board meeting or meeting of a committee of the directors at which the appointing director is not personally present, and generally to perform all the functions of the appointing director in his absence.
- 15.7 For the avoidance of doubt:
- (a) if another director has been appointed an alternate director for one or more directors, he shall be entitled to a separate vote in his own right as a director and in right of each other director for whom he has been appointed an alternate; and

Auth Code: E79632663205  
[www.verify.gov.ky](http://www.verify.gov.ky)



**EXEMPTED** Company Registered and  
filed as No. 396482 On 28-Dec-2022



Acting Assistant Registrar

(b) if a person other than a director has been appointed an alternate director for more than one director, he shall be entitled to a separate vote in right of each director for whom he has been appointed an alternate.

15.8 An alternate director, however, is not entitled to receive any remuneration from the Company for services rendered as an alternate director.

**Appointment ceases when the appointor ceases to be a director**

15.9 An alternate director shall cease to be an alternate director if the director who appointed him ceases to be a director.

**Status of alternate director**

15.10 An alternate director shall carry out all functions of the director who made the appointment.

15.11 Save where otherwise expressed, an alternate director shall be treated as a director under these Articles.

15.12 An alternate director is not the agent of the director appointing him.

15.13 An alternate director is not entitled to any remuneration for acting as alternate director.

**Status of the director making the appointment**

15.14 A director who has appointed an alternate is not thereby relieved from the duties which he owes the Company.

**16 Powers of directors**

**Powers of directors**

16.1 Subject to the provisions of the Act, the Memorandum and these Articles, the business of the Company shall be managed by the directors who may for that purpose exercise all the powers of the Company.

16.2 No prior act of the directors shall be invalidated by any subsequent alteration of the Memorandum or these Articles. However, to the extent allowed by the Act, Members may by Special Resolution validate any prior or future act of the directors which would otherwise be in breach of their duties.

**Appointments to office**

16.3 The directors may appoint a director:

(a) as chairman of the board of directors;

Auth Code: E79632663205  
[www.verify.gov.ky](http://www.verify.gov.ky)



**EXEMPTED** Company Registered and  
filed as No. 396482 On 28-Dec-2022



Acting Assistant Registrar

(b) as managing director;

(c) to any other executive office

for such period and on such terms, including as to remuneration, as they think fit.

16.4 The appointee must consent in writing to holding that office.

16.5 Where a chairman is appointed he shall, unless unable to do so, preside at every meeting of directors.

16.6 If there is no chairman, or if the chairman is unable to preside at a meeting, that meeting may select its own chairman; or the directors may nominate one of their number to act in place of the chairman should he ever not be available.

16.7 Subject to the provisions of the Act, the directors may also appoint any person, who need not be a director:

(a) as Secretary; and

(b) to any office that may be required

for such period and on such terms, including as to remuneration, as they think fit. In the case of an Officer, that Officer may be given any title the directors decide.

16.8 The Secretary or Officer must consent in writing to holding that office.

16.9 A director, Secretary or other Officer of the Company may not hold the office, or perform the services, of auditor.

#### **Remuneration**

16.10 Every director may be remunerated by the Company for the services he provides for the benefit of the Company, whether as director, employee or otherwise, and shall be entitled to be paid for the expenses incurred in the Company's business including attendance at directors' meetings.

16.11 A director's remuneration shall be fixed by the Company by Ordinary Resolution. Unless that resolution provides otherwise, the remuneration shall be deemed to accrue from day to day.

16.12 Remuneration may take any form and may include arrangements to pay pensions, health insurance, death or sickness benefits, whether to the director or to any other person connected to or related to him.

Auth Code: E79632663205  
[www.verify.gov.ky](http://www.verify.gov.ky)



**EXEMPTED** Company Registered and  
filed as No. 396482 On 28-Dec-2022



Acting Assistant Registrar

- 16.13 Unless his fellow directors determine otherwise, a director is not accountable to the Company for remuneration or other benefits received from any other company which is in the same group as the Company or which has common shareholdings.

**Disclosure of information**

- 16.14 The directors may release or disclose to a third party any information regarding the affairs of the Company, including any information contained in the register of members relating to a Member, (and they may authorise any director, Officer or other authorised agent of the Company to release or disclose to a third party any such information in his possession) if:
- (a) the Company or that person, as the case may be, is lawfully required to do so under the laws of any jurisdiction to which the Company is subject; or
  - (b) such disclosure is in compliance with the rules of any stock exchange upon which the Company's shares are listed; or
  - (c) such disclosure is in accordance with any contract entered into by the Company; or
  - (d) the directors are of the opinion such disclosure would assist or facilitate the Company's operations.

**17 Delegation of powers**

**Power to delegate any of the directors' powers to a committee**

- 17.1 The directors may delegate any of their powers to any committee consisting of one or more persons who need not be Members. Persons on the committee may include non-directors so long as the majority of those persons are directors.
- 17.2 The delegation may be collateral with, or to the exclusion of, the directors' own powers.
- 17.3 The delegation may be on such terms as the directors think fit, including provision for the committee itself to delegate to a sub-committee; save that any delegation must be capable of being revoked or altered by the directors at will.
- 17.4 Unless otherwise permitted by the directors, a committee must follow the procedures prescribed for the taking of decisions by directors.

**Power to appoint an agent of the Company**

- 17.5 The directors may appoint any person, either generally or in respect of any specific matter, to be the agent of the Company with or without authority for that person to delegate all or any of that person's powers. The directors may make that appointment:
- (a) by causing the Company to enter into a power of attorney or agreement; or

Auth Code: E79632663205  
[www.verify.gov.ky](http://www.verify.gov.ky)



**EXEMPTED** Company Registered and  
filed as No. 396482 On 28-Dec-2022



Acting Assistant Registrar

(b) in any other manner they determine.

**Power to appoint an attorney or authorised signatory of the Company**

17.6 The directors may appoint any person, whether nominated directly or indirectly by the directors, to be the attorney or the authorised signatory of the Company. The appointment may be:

- (a) for any purpose;
- (b) with the powers, authorities and discretions;
- (c) for the period; and
- (d) subject to such conditions

as they think fit. The powers, authorities and discretions, however, must not exceed those vested in, or exercisable, by the directors under these Articles. The directors may do so by power of attorney or any other manner they think fit.

17.7 Any power of attorney or other appointment may contain such provision for the protection and convenience for persons dealing with the attorney or authorised signatory as the directors think fit. Any power of attorney or other appointment may also authorise the attorney or authorised signatory to delegate all or any of the powers, authorities and discretions vested in that person.

**Power to appoint a proxy**

17.8 Any director may appoint any other person, including another director, to represent him at any meeting of the directors. If a director appoints a proxy, then for all purposes the presence or vote of the proxy shall be deemed to be that of the appointing director.

17.9 Articles 15.1 to 15.4 inclusive (relating to the appointment by directors of alternate directors) apply, mutatis mutandis, to the appointment of proxies by directors.

17.10 A proxy is an agent of the director appointing him and is not an officer of the Company.

**18 Meetings of directors**

**Regulation of directors' meetings**

18.1 Subject to the provisions of these Articles, the directors may regulate their proceedings as they think fit.

Auth Code: E79632663205  
[www.verify.gov.ky](http://www.verify.gov.ky)



**EXEMPTED** Company Registered and  
filed as No. 396482 On 28-Dec-2022



Acting Assistant Registrar

#### **Calling meetings**

18.2 Any director may call a meeting of directors at any time. The Secretary, if any, must call a meeting of the directors if requested to do so by a director.

#### **Notice of meetings**

18.3 Every director shall be given notice of a meeting, although a director may waive retrospectively the requirement to be given notice. Notice may be oral.

#### **Period of notice**

18.4 At least five Clear Days' notice of a meeting of directors must be given to directors. But a meeting may be convened on shorter notice with the consent of all directors.

#### **Use of technology**

18.5 A director may participate in a meeting of directors through the medium of conference telephone, video or any other form of communications equipment providing all persons participating in the meeting are able to hear and speak to each other throughout the meeting.

18.6 A director participating in this way is deemed to be present in person at the meeting.

#### **Place of meetings**

18.7 If all the directors participating in a meeting are not in the same place, they may decide that the meeting is to be treated as taking place wherever any of them is.

#### **Quorum**

18.8 The quorum for the transaction of business at a meeting of directors shall be two unless the directors fix some other number or unless the Company has only one director.

#### **Voting**

18.9 A question which arises at a board meeting shall be decided by a majority of votes. If votes are equal the chairman may, if he wishes, exercise a casting vote.

#### **Validity**

18.10 Anything done at a meeting of directors is unaffected by the fact that it is later discovered that any person was not properly appointed, or had ceased to be a director, or was otherwise not entitled to vote.

Auth Code: E79632663205

[www.verify.gov.ky](http://www.verify.gov.ky)



**EXEMPTED** Company Registered and  
filed as No. 396482 On 28-Dec-2022



Acting Assistant Registrar

#### **Recording of dissent**

18.11 A director present at a meeting of directors shall be presumed to have assented to any action taken at that meeting unless:

- (a) his dissent is entered in the minutes of the meeting; or
- (b) he has filed with the meeting before it is concluded signed dissent from that action; or
- (c) he has forwarded to the Company as soon as practical following the conclusion of that meeting signed dissent.

A director who votes in favour of an action is not entitled to record his dissent to it.

#### **Written resolutions**

18.12 The directors may pass a resolution in writing without holding a meeting if all directors sign a document or sign several documents in the like form each signed by one or more of those directors.

18.13 Despite the foregoing, a resolution in writing signed by a validly appointed alternate director or by a validly appointed proxy need not also be signed by the appointing director. But if a written resolution is signed personally by the appointing director, it need not also be signed by his alternate or proxy.

18.14 Such written resolution shall be as effective as if it had been passed at a meeting of the directors duly convened and held; and it shall be treated as having been passed on the day and at the time that the last director signs.

#### **Sole director's minute**

18.15 Where a sole director signs a minute recording his decision on a question, that record shall constitute the passing of a resolution in those terms.

#### **19 Permissible directors' interests and disclosure**

##### **Permissible interests subject to disclosure**

19.1 Save as expressly permitted by these Articles or as set out below, a director may not have a direct or indirect interest or duty which conflicts or may possibly conflict with the interests of the Company.

19.2 If, notwithstanding the prohibition in the preceding Article, a director discloses to his fellow directors the nature and extent of any material interest or duty in accordance with the next Article, he may:

Auth Code: E79632663205

[www.verify.gov.ky](http://www.verify.gov.ky)



**EXEMPTED** Company Registered and  
filed as No. 396482 On 28-Dec-2022



Acting Assistant Registrar

- (a) be a party to, or otherwise interested in, any transaction or arrangement with the Company or in which the Company is or may otherwise be interested;
  - (b) be interested in another body corporate promoted by the Company or in which the Company is otherwise interested. In particular, the director may be a director, secretary or officer of, or employed by, or be a party to any transaction or arrangement with, or otherwise interested in, that other body corporate.
- 19.3 Such disclosure may be made at a meeting of the board or otherwise (and, if otherwise, it must be made in writing). The director must disclose the nature and extent of his direct or indirect interest in or duty in relation to a transaction or arrangement or series of transactions or arrangements with the Company or in which the Company has any material interest.
- 19.4 If a director has made disclosure in accordance with the preceding Article, then he shall not, by reason only of his office, be accountable to the Company for any benefit that he derives from any such transaction or arrangement or from any such office or employment or from any interest in any such body corporate, and no such transaction or arrangement shall be liable to be avoided on the ground of any such interest or benefit.

#### **Notification of interests**

- 19.5 For the purposes of the preceding Articles:
- (a) a general notice that a director gives to the other directors that he is to be regarded as having an interest of the nature and extent specified in the notice in any transaction or arrangement in which a specified person or class of persons is interested shall be deemed to be a disclosure that he has an interest in or duty in relation to any such transaction of the nature and extent so specified; and
  - (b) an interest of which a director has no knowledge and of which it is unreasonable to expect him to have knowledge shall not be treated as an interest of his.
- 19.6 A director shall not be treated as having an interest in a transaction or arrangement if he has no knowledge of that interest and it is unreasonable to expect the director to have that knowledge.

#### **Voting where a director is interested in a matter**

- 19.7 A director may vote at a meeting of directors on any resolution concerning a matter in which that director has an interest or duty, whether directly or indirectly, so long as that director discloses any material interest pursuant to these Articles. The director shall be counted towards a quorum of those present at the meeting. If the director votes on the resolution, his vote shall be counted.

Auth Code: E79632663205  
[www.verify.gov.ky](http://www.verify.gov.ky)





**EXEMPTED** Company Registered and  
filed as No. 396482 On 28-Dec-2022



Acting Assistant Registrar

19.8 Where proposals are under consideration concerning the appointment of two or more directors to offices or employment with the Company or any body corporate in which the Company is interested, the proposals may be divided and considered in relation to each director separately and each of the directors concerned shall be entitled to vote and be counted in the quorum in respect of each resolution except that concerning his or her own appointment.

## **20 Minutes**

The Company shall cause minutes to be made in books kept for the purpose in accordance with the Act.

## **21 Accounts and audit**

### **Accounting and other records**

21.1 The directors must ensure that proper accounting and other records are kept, and that accounts and associated reports are distributed in accordance with the requirements of the Act.

### **No automatic right of inspection**

21.2 Members are only entitled to inspect the Company's records if they are expressly entitled to do so by law, or by resolution made by the directors or passed by Ordinary Resolution.

### **Sending of accounts and reports**

21.3 The Company's accounts and associated directors' report or auditor's report that are required or permitted to be sent to any person pursuant to any law shall be treated as properly sent to that person if:

- (a) they are sent to that person in accordance with the notice provisions: or
- (b) they are published on a website providing that person is given separate notice of:
  - (i) the fact that publication of the documents has been published on the website;
  - (ii) the address of the website; and
  - (iii) the place on the website where the documents may be accessed; and
  - (iv) how they may be accessed.

21.4 If, for any reason, a person notifies the Company that he is unable to access the website, the Company must, as soon as practicable, send the documents to that person by any other means permitted by these Articles. This, however, will not affect when that person is taken to have received the documents under the next Article.

Auth Code: E79632663205  
[www.verify.gov.ky](http://www.verify.gov.ky)



**EXEMPTED** Company Registered and  
filed as No. 396482 On 28-Dec-2022



Acting Assistant Registrar

**Time of receipt if documents are published on a website**

- 21.5 Documents sent by being published on a website in accordance with the preceding two Articles are only treated as sent at least five Clear Days before the date of the meeting at which they are to be laid if:
- (a) the documents are published on the website throughout a period beginning at least five Clear Days before the date of the meeting and ending with the conclusion of the meeting; and
  - (b) the person is given at least five Clear Days' notice of the hearing.

**Validity despite accidental error in publication on website**

- 21.6 If, for the purpose of a meeting, documents are sent by being published on a website in accordance with the preceding Articles, the proceedings at that meeting are not invalidated merely because:
- (a) those documents are, by accident, published in a different place on the website to the place notified; or
  - (b) they are published for part only of the period from the date of notification until the conclusion of that meeting.

**When accounts are to be audited**

- 21.7 Unless the directors or the Members, by Ordinary Resolution, so resolve or unless the Act so requires, the Company's accounts will not be audited. If the Members so resolve, the Company's accounts shall be audited in the manner determined by Ordinary Resolution. Alternatively, if the directors so resolve, they shall be audited in the manner they determine.

**22 Financial year**

Unless the directors otherwise specify, the financial year of the Company:

- (a) shall end on 31st December in the year of its incorporation and each following year; and
- (b) shall begin when it was incorporated and on 1st January each following year.

Auth Code: E79632663205  
[www.verify.gov.ky](http://www.verify.gov.ky)



**EXEMPTED** Company Registered and  
filed as No. 396482 On 28-Dec-2022



Acting Assistant Registrar

### 23 Record dates

Except to the extent of any conflicting rights attached to Shares, the directors may fix any time and date as the record date for declaring or paying a dividend or making or issuing an allotment of Shares. The record date may be before or after the date on which a dividend, allotment or issue is declared, paid or made.

### 24 Dividends

#### Declaration of dividends by Members

24.1 Subject to the provisions of the Act, the Company may by Ordinary Resolution declare dividends in accordance with the respective rights of the Members but no dividend shall exceed the amount recommended by the directors.

#### Payment of interim dividends and declaration of final dividends by directors

24.2 The directors may pay interim dividends or declare final dividends in accordance with the respective rights of the Members if it appears to them that they are justified by the financial position of the Company and that such dividends may lawfully be paid.

24.3 Subject to the provisions of the Act, in relation to the distinction between interim dividends and final dividends, the following applies:

- (a) Upon determination to pay a dividend or dividends described as interim by the directors in the dividend resolution, no debt shall be created by the declaration until such time as payment is made.
- (b) Upon declaration of a dividend or dividends described as final by the directors in the dividend resolution, a debt shall be created immediately following the declaration, the due date to be the date the dividend is stated to be payable in the resolution.

If the resolution fails to specify whether a dividend is final or interim, it shall be assumed to be interim.

24.4 In relation to Shares carrying differing rights to dividends or rights to dividends at a fixed rate, the following applies:

- (a) If the share capital is divided into different classes, the directors may pay dividends on Shares which confer deferred or non-preferred rights with regard to dividends as well as on Shares which confer preferential rights with regard to dividends but no dividend shall be paid on Shares carrying deferred or non-preferred rights if, at the time of payment, any preferential dividend is in arrears.

Auth Code: E79632663205  
[www.verify.gov.ky](http://www.verify.gov.ky)



**EXEMPTED** Company Registered and  
filed as No. 396482 On 28-Dec-2022



Acting Assistant Registrar

- (b) The directors may also pay, at intervals settled by them, any dividend payable at a fixed rate if it appears to them that there are sufficient funds of the Company lawfully available for distribution to justify the payment.
- (c) If the directors act in good faith, they shall not incur any liability to the Members holding Shares conferring preferred rights for any loss those Members may suffer by the lawful payment of the dividend on any Shares having deferred or non-preferred rights.

#### **Apportionment of dividends**

- 24.5 Except as otherwise provided by the rights attached to Shares, all dividends shall be declared and paid according to the amounts paid up on the Shares on which the dividend is paid. All dividends shall be apportioned and paid proportionately to the amount paid up on the Shares during the time or part of the time in respect of which the dividend is paid. But if a Share is issued on terms providing that it shall rank for dividend as from a particular date, that Share shall rank for dividend accordingly.

#### **Right of set off**

- 24.6 The directors may deduct from a dividend or any other amount payable to a person in respect of a Share any amount due by that person to the Company on a call or otherwise in relation to a Share.

#### **Power to pay other than in cash**

- 24.7 If the directors so determine, any resolution declaring a dividend may direct that it shall be satisfied wholly or partly by the distribution of assets. If a difficulty arises in relation to the distribution, the directors may settle that difficulty in any way they consider appropriate. For example, they may do any one or more of the following:
- (a) issue fractional Shares;
  - (b) fix the value of assets for distribution and make cash payments to some Members on the footing of the value so fixed in order to adjust the rights of Members; and
  - (c) vest some assets in trustees.

#### **How payments may be made**

- 24.8 A dividend or other monies payable on or in respect of a Share may be paid in any of the following ways:
- (a) if the Member holding that Share or other person entitled to that Share nominates a bank account for that purpose - by wire transfer to that bank account;  
or

Auth Code: E79632663205

[www.verify.gov.ky](http://www.verify.gov.ky)



**EXEMPTED** Company Registered and  
filed as No. 396482 On 28-Dec-2022



Acting Assistant Registrar

(b) by cheque or warrant sent by post to the registered address of the Member holding that Share or other person entitled to that Share.

24.9 For the purpose of paragraph (a) of the preceding Article, the nomination may be in writing or in an Electronic Record and the bank account nominated may be the bank account of another person. For the purpose of paragraph (b) of the preceding Article, subject to any applicable law or regulation, the cheque or warrant shall be made to the order of the Member holding that Share or other person entitled to the Share or to his nominee, whether nominated in writing or in an Electronic Record, and payment of the cheque or warrant shall be a good discharge to the Company.

24.10 If two or more persons are registered as the holders of the Share or are jointly entitled to it by reason of the death or bankruptcy of the registered holder (**Joint Holders**), a dividend (or other amount) payable on or in respect of that Share may be paid as follows:

(a) to the registered address of the Joint Holder of the Share who is named first on the register of members or to the registered address of the deceased or bankrupt holder, as the case may be; or

(b) to the address or bank account of another person nominated by the Joint Holders, whether that nomination is in writing or in an Electronic Record.

24.11 Any Joint Holder of a Share may give a valid receipt for a dividend (or other amount) payable in respect of that Share.

**Dividends or other moneys not to bear interest in absence of special rights**

24.12 Unless provided for by the rights attached to a Share, no dividend or other monies payable by the Company in respect of a Share shall bear interest.

**Dividends unable to be paid or unclaimed**

24.13 If a dividend cannot be paid to a Member or remains unclaimed within six weeks after it was declared or both, the directors may pay it into a separate account in the Company's name. If a dividend is paid into a separate account, the Company shall not be constituted trustee in respect of that account and the dividend shall remain a debt due to the Member.

24.14 A dividend that remains unclaimed for a period of six years after it became due for payment shall be forfeited to, and shall cease to remain owing by, the Company.

Auth Code: E79632663205  
[www.verify.gov.ky](http://www.verify.gov.ky)



**EXEMPTED** Company Registered and  
filed as No. 396482 On 28-Dec-2022



Acting Assistant Registrar

## 25 Capitalisation of profits

### Capitalisation of profits or of any share premium account or capital redemption reserve

25.1 The directors may resolve to capitalise:

- (a) any part of the Company's profits not required for paying any preferential dividend (whether or not those profits are available for distribution); or
- (b) any sum standing to the credit of the Company's share premium account or capital redemption reserve, if any.

The amount resolved to be capitalised must be appropriated to the Members who would have been entitled to it had it been distributed by way of dividend and in the same proportions. The benefit to each Member so entitled must be given in either or both of the following ways:

- (a) by paying up the amounts unpaid on that Member's Shares;
- (b) by issuing Fully Paid Shares, debentures or other securities of the Company to that Member or as that Member directs. The directors may resolve that any Shares issued to the Member in respect of partly paid Shares (**Original Shares**) rank for dividend only to the extent that the Original Shares rank for dividend while those Original Shares remain partly paid.

### Applying an amount for the benefit of members

25.2 The amount capitalised must be applied to the benefit of Members in the proportions to which the Members would have been entitled to dividends if the amount capitalised had been distributed as a dividend.

25.3 Subject to the Act, if a fraction of a Share, a debenture, or other security is allocated to a Member, the directors may issue a fractional certificate to that Member or pay him the cash equivalent of the fraction.

## 26 Share premium account

### Directors to maintain share premium account

26.1 The directors shall establish a share premium account in accordance with the Act. They shall carry to the credit of that account from time to time an amount equal to the amount or value of the premium paid on the issue of any Share or capital contributed or such other amounts required by the Act.

### Debits to share premium account

26.2 The following amounts shall be debited to any share premium account:

- (a) on the redemption or purchase of a Share, the difference between the nominal value of that Share and the redemption or purchase price; and
- (b) any other amount paid out of a share premium account as permitted by the Act. 43

Auth Code: E79632663205  
[www.verify.gov.ky](http://www.verify.gov.ky)



**EXEMPTED** Company Registered and  
filed as No. 396482 On 28-Dec-2022



Acting Assistant Registrar

26.3 Notwithstanding the preceding Article, on the redemption or purchase of a Share, the directors may pay the difference between the nominal value of that Share and the redemption purchase price out of the profits of the Company or, as permitted by the Act, out of capital.

## 27 Seal

### Company seal

27.1 The Company may have a seal if the directors so determine.

### Duplicate seal

27.2 Subject to the provisions of the Act, the Company may also have a duplicate seal or seals for use in any place or places outside the Islands. Each duplicate seal shall be a facsimile of the original seal of the Company. However, if the directors so determine, a duplicate seal shall have added on its face the name of the place where it is to be used.

### When and how seal is to be used

27.3 A seal may only be used by the authority of the directors. Unless the directors otherwise determine, a document to which a seal is affixed must be signed in one of the following ways:

- (a) by a director (or his alternate) and the Secretary; or
- (b) by a single director (or his alternate).

### If no seal is adopted or used

27.4 If the directors do not adopt a seal, or a seal is not used, a document may be executed in the following manner:

- (a) by a director (or his alternate) and the Secretary; or
- (b) by a single director (or his alternate); or
- (c) in any other manner permitted by the Act.

### Power to allow non-manual signatures and facsimile printing of seal

27.5 The directors may determine that either or both of the following applies:

- (a) that the seal or a duplicate seal need not be affixed manually but may be affixed by some other method or system of reproduction;

Auth Code: E79632663205  
[www.verify.gov.ky](http://www.verify.gov.ky)



**EXEMPTED** Company Registered and  
filed as No. 396482 On 28-Dec-2022



Acting Assistant Registrar

(b) that a signature required by these Articles need not be manual but may be a mechanical or Electronic Signature.

#### **Validity of execution**

27.6 If a document is duly executed and delivered by or on behalf of the Company, it shall not be regarded as invalid merely because, at the date of the delivery, the Secretary, or the director, or other Officer or person who signed the document or affixed the seal for and on behalf of the Company ceased to be the Secretary or hold that office and authority on behalf of the Company.

#### **28 Indemnity**

##### **Indemnity**

28.1 To the extent permitted by law, the Company shall indemnify each existing or former Secretary, director (including alternate director), and other Officer of the Company (including an investment adviser or an administrator or liquidator) and their personal representatives against:

- (a) all actions, proceedings, costs, charges, expenses, losses, damages or liabilities incurred or sustained by the existing or former Secretary or Officer in or about the conduct of the Company's business or affairs or in the execution or discharge of the existing or former Secretary's or Officer's duties, powers, authorities or discretions; and
- (b) without limitation to paragraph (a), all costs, expenses, losses or liabilities incurred by the existing or former Secretary or Officer in defending (whether successfully or otherwise) any civil, criminal, administrative or investigative proceedings (whether threatened, pending or completed) concerning the Company or its affairs in any court or tribunal, whether in the Islands or elsewhere.

No such existing or former Secretary or Officer, however, shall be indemnified in respect of any matter arising out of his own dishonesty.

28.2 To the extent permitted by law, the Company may make a payment, or agree to make a payment, whether by way of advance, loan or otherwise, for any legal costs incurred by an existing or former Secretary or Officer of the Company in respect of any matter identified in paragraph (a) or paragraph (b) of the preceding Article on condition that the Secretary or Officer must repay the amount paid by the Company to the extent that it is ultimately found not liable to indemnify the Secretary or that Officer for those legal costs.

Auth Code: E79632663205  
[www.verify.gov.ky](http://www.verify.gov.ky)





**EXEMPTED** Company Registered and  
filed as No. 396482 On 28-Dec-2022



Acting Assistant Registrar

## Release

28.3 To the extent permitted by law, the Company may by Special Resolution release any existing or former director (including alternate director), Secretary or other Officer of the Company from liability for any loss or damage or right to compensation which may arise out of or in connection with the execution or discharge of the duties, powers, authorities or discretions of his office; but there may be no release from liability arising out of or in connection with that person's own dishonesty.

## Insurance

28.4 To the extent permitted by law, the Company may pay, or agree to pay, a premium in respect of a contract insuring each of the following persons against risks determined by the directors, other than liability arising out of that person's own dishonesty:

- (a) an existing or former director (including alternate director), Secretary or Officer or auditor of:
  - (i) the Company;
  - (ii) a company which is or was a subsidiary of the Company;
  - (iii) a company in which the Company has or had an interest (whether direct or indirect); and
- (b) a trustee of an employee or retirement benefits scheme or other trust in which any of the persons referred to in paragraph (a) is or was interested.

## 29 Notices

### Form of notices

29.1 Save where these Articles provide otherwise, any notice to be given to or by any person pursuant to these Articles shall be:

- (a) in writing signed by or on behalf of the giver in the manner set out below for written notices; or
- (b) subject to the next Article, in an Electronic Record signed by or on behalf of the giver by Electronic Signature and authenticated in accordance with Articles about authentication of Electronic Records; or
- (c) where these Articles expressly permit, by the Company by means of a website.

Auth Code: E79632663205  
[www.verify.gov.ky](http://www.verify.gov.ky)



**EXEMPTED** Company Registered and  
filed as No. 396482 On 28-Dec-2022



Acting Assistant Registrar

#### **Electronic communications**

29.2 Without limitation to Articles 15.1 to 15.4 inclusive (relating to the appointment and removal by directors of alternate directors) and to Articles 17.8 to 17.10 inclusive (relating to the appointment by directors of proxies), a notice may only be given to the Company in an Electronic Record if:

- (a) the directors so resolve;
- (b) the resolution states how an Electronic Record may be given and, if applicable, specifies an email address for the Company; and
- (c) the terms of that resolution are notified to the Members for the time being and, if applicable, to those directors who were absent from the meeting at which the resolution was passed.

If the resolution is revoked or varied, the revocation or variation shall only become effective when its terms have been similarly notified.

29.3 A notice may not be given by Electronic Record to a person other than the Company unless the recipient has notified the giver of an Electronic address to which notice may be sent.

#### **Persons authorised to give notices**

29.4 A notice by either the Company or a Member pursuant to these Articles may be given on behalf of the Company or a Member by a director or company secretary of the Company or a Member.

#### **Delivery of written notices**

29.5 Save where these Articles provide otherwise, a notice in writing may be given personally to the recipient, or left at (as appropriate) the Member's or director's registered address or the Company's registered office, or posted to that registered address or registered office.

#### **Joint holders**

29.6 Where Members are joint holders of a Share, all notices shall be given to the Member whose name first appears in the register of members.

#### **Signatures**

29.7 A written notice shall be signed when it is autographed by or on behalf of the giver, or is marked in such a way as to indicate its execution or adoption by the giver.

29.8 An Electronic Record may be signed by an Electronic Signature.

Auth Code: E79632663205

[www.verify.gov.ky](http://www.verify.gov.ky)



**EXEMPTED** Company Registered and  
filed as No. 396482 On 28-Dec-2022



Acting Assistant Registrar

#### Evidence of transmission

- 29.9 A notice given by Electronic Record shall be deemed sent if an Electronic Record is kept demonstrating the time, date and content of the transmission, and if no notification of failure to transmit is received by the giver.
- 29.10 A notice given in writing shall be deemed sent if the giver can provide proof that the envelope containing the notice was properly addressed, pre-paid and posted, or that the written notice was otherwise properly transmitted to the recipient.

#### Giving notice to a deceased or bankrupt Member

- 29.11 A notice may be given by the Company to the persons entitled to a Share in consequence of the death or bankruptcy of a Member by sending or delivering it, in any manner authorised by these Articles for the giving of notice to a Member, addressed to them by name, or by the title of representatives of the deceased, or trustee of the bankrupt or by any like description, at the address, if any, supplied for that purpose by the persons claiming to be so entitled.
- 29.12 Until such an address has been supplied, a notice may be given in any manner in which it might have been given if the death or bankruptcy had not occurred.

#### Date of giving notices

- 29.13 A notice is given on the date identified in the following table.

Method for giving notices	When taken to be given
Personally	At the time and date of delivery
By leaving it at the member's registered address	At the time and date it was left
If the recipient has an address within the Islands, by posting it by prepaid post to the street or postal address of that recipient	48 hours after it was posted
If the recipient has an address outside the Islands, by posting it by prepaid airmail to	7 Clear Days after posting

Auth Code: E79632663205  
[www.verify.gov.ky](http://www.verify.gov.ky)



**EXEMPTED** Company Registered and  
filed as No. 396482 On 28-Dec-2022



Acting Assistant Registrar

the street or postal address of that recipient	
By Electronic Record (other than publication on a website), to recipient's Electronic address	Within 24 hours after it was sent
By publication on a website	See the Articles about the time when notice of a meeting of Members or accounts and reports, as the case may be, are published on a website

**Saving provision**

29.14 None of the preceding notice provisions shall derogate from the Articles about the delivery of written resolutions of directors and written resolutions of Members.

**30 Authentication of Electronic Records**

**Application of Articles**

30.1 Without limitation to any other provision of these Articles, any notice, written resolution or other document under these Articles that is sent by Electronic means by a Member, or by the Secretary, or by a director or other Officer of the Company, shall be deemed to be authentic if either Article 30.2 or Article 30.4 applies.

**Authentication of documents sent by Members by Electronic means**

30.2 An Electronic Record of a notice, written resolution or other document sent by Electronic means by or on behalf of one or more Members shall be deemed to be authentic if the following conditions are satisfied:

- (a) the Member or each Member, as the case may be, signed the original document, and for this purpose **Original Document** includes several documents in like form signed by one or more of those Members; and
- (b) the Electronic Record of the Original Document was sent by Electronic means by, or at the direction of, that Member to an address specified in accordance with these Articles for the purpose for which it was sent; and
- (c) Article 30.7 does not apply.

Auth Code: E79632663205  
[www.verify.gov.ky](http://www.verify.gov.ky)



**EXEMPTED** Company Registered and  
filed as No. 396482 On 28-Dec-2022



Acting Assistant Registrar

30.3 For example, where a sole Member signs a resolution and sends the Electronic Record of the original resolution, or causes it to be sent, by facsimile transmission to the address in these Articles specified for that purpose, the facsimile copy shall be deemed to be the written resolution of that Member unless Article 30.7 applies.

**Authentication of document sent by the Secretary or Officers of the Company by Electronic means**

30.4 An Electronic Record of a notice, written resolution or other document sent by or on behalf of the Secretary or an Officer or Officers of the Company shall be deemed to be authentic if the following conditions are satisfied:

- (a) the Secretary or the Officer or each Officer, as the case may be, signed the original document, and for this purpose **Original Document** includes several documents in like form signed by the Secretary or one or more of those Officers; and
- (b) the Electronic Record of the Original Document was sent by Electronic means by, or at the direction of, the Secretary or that Officer to an address specified in accordance with these Articles for the purpose for which it was sent; and
- (c) Article 30.7 does not apply.

This Article applies whether the document is sent by or on behalf of the Secretary or Officer in his own right or as a representative of the Company.

30.5 For example, where a sole director signs a resolution and scans the resolution, or causes it to be scanned, as a PDF version which is attached to an email sent to the address in these Articles specified for that purpose, the PDF version shall be deemed to be the written resolution of that director unless Article 30.7 applies.

**Manner of signing**

30.6 For the purposes of these Articles about the authentication of Electronic Records, a document will be taken to be signed if it is signed manually or in any other manner permitted by these Articles.

**Saving provision**

30.7 A notice, written resolution or other document under these Articles will not be deemed to be authentic if the recipient, acting reasonably:

- (a) believes that the signature of the signatory has been altered after the signatory had signed the original document; or

Auth Code: E79632663205  
[www.verify.gov.ky](http://www.verify.gov.ky)



**EXEMPTED** Company Registered and  
filed as No. 396482 On 28-Dec-2022



Acting Assistant Registrar

- (b) believes that the original document, or the Electronic Record of it, was altered, without the approval of the signatory, after the signatory signed the original document; or
- (c) otherwise doubts the authenticity of the Electronic Record of the document

and the recipient promptly gives notice to the sender setting the grounds of its objection. If the recipient invokes this Article, the sender may seek to establish the authenticity of the Electronic Record in any way the sender thinks fit.

### **31 Transfer by way of continuation**

31.1 The Company may, by Special Resolution, resolve to be registered by way of continuation in a jurisdiction outside:

- (a) the Islands; or
- (b) such other jurisdiction in which it is, for the time being, incorporated, registered or existing.

31.2 To give effect to any resolution made pursuant to the preceding Article, the directors may cause the following:

- (a) an application be made to the Registrar of Companies to deregister the Company in the Islands or in the other jurisdiction in which it is for the time being incorporated, registered or existing; and
- (b) all such further steps as they consider appropriate to be taken to effect the transfer by way of continuation of the Company.

### **32 Winding up**

#### **Distribution of assets in specie**

32.1 If the Company is wound up, the Members may, subject to these Articles and any other sanction required by the Act, pass a Special Resolution allowing the liquidator to do either or both of the following:

- (a) to divide in specie among the Members the whole or any part of the assets of the Company and, for that purpose, to value any assets and to determine how the division shall be carried out as between the Members or different classes of Members;
- (b) to vest the whole or any part of the assets in trustees for the benefit of Members and those liable to contribute to the winding up.

Auth Code: E79632663205  
[www.verify.gov.ky](http://www.verify.gov.ky)



**EXEMPTED** Company Registered and  
filed as No. 396482 On 28-Dec-2022



Acting Assistant Registrar

**No obligation to accept liability**

- 32.2 No Member shall be compelled to accept any assets if an obligation attaches to them. **The directors are authorised to present a winding up petition**
- 32.3 The directors have the authority to present a petition for the winding up of the Company to the Grand Court of the Cayman Islands on behalf of the Company without the sanction of a resolution passed at a general meeting.

**33 Amendment of Memorandum and Articles**

**Power to change name or amend Memorandum**

- 33.1 Subject to the Act, the Company may, by Special Resolution:
- (a) change its name; or
  - (b) change the provisions of its Memorandum with respect to its objects, powers or any other matter specified in the Memorandum.

**Power to amend these Articles**

- 33.2 Subject to the Act and as provided in these Articles, the Company may, by Special Resolution, amend these Articles in whole or in part.

Auth Code: E79632663205  
[www.verify.gov.ky](http://www.verify.gov.ky)



**EXEMPTED** Company Registered and  
filed as No. 396482 On 28-Dec-2022



Acting Assistant Registrar

Dated 28 December 2022

Name and address of Subscriber	Number of shares taken	Signature
Ogier Global Subscriber (Cayman) Limited  89 Nexus Way  Camana Bay  Grand Cayman, KY1-9009  Cayman Islands	1	per: Name: Corinne Cellier  Authorised Signatory
<b>Witness to above signature</b>	Name: Yanique Arthurs  Ogier Global (Cayman) Limited 89 Nexus Way Camana Bay Grand Cayman, KY1-9009 Cayman Islands  Occupation: Administrator	

Auth Code: E79632663205  
[www.verify.gov.ky](http://www.verify.gov.ky)



**Companies Act (Revised)  
Company Limited by Shares**

---

**AMENDED AND RESTATED  
MEMORANDUM OF ASSOCIATION  
OF  
NOCO-NOCO INC.**

---

(Adopted by special resolution passed on [●] 2023)



**Companies Act (Revised)**

**Company Limited by Shares**

**Amended and Restated Memorandum of Association**

**of**

**noco-noco Inc.**

(Adopted by special resolution passed on [●] 2023)

- 1 The name of the Company is **noco-noco Inc.**
  - 2 The Company's registered office will be situated at the office of Ogier Global (Cayman) Limited, 89 Nexus Way, Camana Bay, Grand Cayman, KY1-9009, Cayman Islands or at such other place in the Cayman Islands as the directors may at any time decide.
  - 3 The Company's objects are unrestricted. As provided by section 7(4) of the Companies Act (Revised), the Company has full power and authority to carry out any object not prohibited by any law of the Cayman Islands.
  - 4 The Company has unrestricted corporate capacity. Without limitation to the foregoing, as provided by section 27 (2) of the Companies Act (Revised), the Company has and is capable of exercising all the functions of a natural person of full capacity irrespective of any question of corporate benefit.
  - 5 Nothing in any of the preceding paragraphs permits the Company to carry on any of the following businesses without being duly licensed, namely:
    - (a) the business of a bank or trust company without being licensed in that behalf under the Banks and Trust Companies Act (Revised); or
    - (b) insurance business from within the Cayman Islands or the business of an insurance manager, agent, sub-agent or broker without being licensed in that behalf under the Insurance Act (Revised); or
    - (c) the business of company management without being licensed in that behalf under the Companies Management Act (Revised).
  - 6 Unless licensed to do so, the Company will not trade in the Cayman Islands with any person, firm or corporation except in furtherance of its business carried on outside the Cayman Islands. Despite this, the Company may effect and conclude contracts in the Cayman Islands and exercise in the Cayman Islands any of its powers necessary for the carrying on of its business outside the Cayman Islands.
-

- 7 The Company is a company limited by shares and accordingly the liability of each member is limited to the amount (if any) unpaid on that member's shares.
- 8 The share capital of the Company is USD50,000 divided into 500,000,000 Ordinary Shares of par value USD0.0001 each. However, subject to the Companies Act (Revised) and the Company's articles of association, the Company has power to do any one or more of the following:
- (a) to redeem or repurchase any of its shares; and
  - (b) to increase or reduce its capital; and
  - (c) to issue any part of its capital (whether original, redeemed, increased or reduced):
    - (i) with or without any preferential, deferred, qualified or special rights, privileges or conditions; or
    - (ii) subject to any limitations or restrictionsand unless the condition of issue expressly declares otherwise, every issue of shares (whether declared to be ordinary, preference or otherwise) is subject to this power; or
  - (d) to alter any of those rights, privileges, conditions, limitations or restrictions.
- 9 The Company has power to register by way of continuation as a body corporate limited by shares under the laws of any jurisdiction outside the Cayman Islands and to be deregistered in the Cayman Islands.
-

**Companies Act (Revised)**  
**Company Limited By Shares**

---

**AMENDED AND RESTATED  
ARTICLES OF ASSOCIATION  
OF  
NOCO-NOCO INC.**

---

(Adopted by special resolution passed on [●] 2023)



## Contents

1	Definitions, interpretation and exclusion of Table A	1
2	Shares	5
3	Share certificates	9
4	Lien on Shares	10
5	Calls on Shares and forfeiture	12
6	Transfer of Shares	15
7	Transmission of Shares	16
8	Alteration of capital	17
9	Redemption and purchase of own Shares	18
10	Meetings of Members	20
11	Proceedings at meetings of Members	22
12	Voting rights of Members	26
13	Number of Directors	30
14	Appointment, disqualification and removal of Directors	30
15	Alternate Directors	33
16	Powers of Directors	34
17	Delegation of powers	37
18	Meetings of Directors	39
19	Permissible Directors' interests and disclosure	41
20	Minutes	42
21	Accounts and audit; Financial year	43
22	Record dates	43
23	Dividends	44
24	Capitalisation of profits	46
25	Share Premium Account	47
26	Seal	48
27	Indemnity	49
28	Notices	50
29	Authentication of Electronic Records	54
30	Transfer by way of continuation	55
31	Winding up	56
32	Amendment of Memorandum and Articles	56
33	Mergers and Consolidations	57
34	Certain Tax Filings	57

---

**Companies Act (Revised)**  
**Company Limited by Shares**  
**Amended and Restated Articles of Association**  
**of**

**noco-noco Inc.** (Adopted by special resolution passed on [●] 2023)

**1 Definitions, interpretation and exclusion of Table A**

**Definitions**

1.1 In these Articles, the following definitions apply:

**Act** means the Companies Act (Revised) of the Cayman Islands, including any statutory modification or re-enactment thereof for the time being in force;

**Articles** means, as appropriate:

(a) these articles of association as amended from time to time; or

(b) two or more particular articles of these Articles;

and **Article** refers to a particular article of these Articles;

**Auditors** means the auditor or auditors for the time being of the Company;

**Board** means the board of Directors from time to time;

**Business Day** means a day, other than a day on which banking institutions or trust companies are authorised or obligated by law to close in New York City, Singapore or Japan, when banks in Grand Cayman, the Cayman Islands are open for the transaction of normal banking business and for the avoidance of doubt, shall not include a Saturday, Sunday or public holiday in the Cayman Islands;

**Cayman Islands** means the British Overseas Territory of the Cayman Islands;

**Clear Days**, in relation to a period of notice, means that period excluding:

(a) the day when the notice is given or deemed to be given; and

(b) the day for which it is given or on which it is to take effect;

**Clearing House** means a clearing house recognised by the laws of the jurisdiction in which the Shares (or depositary receipts therefor) are listed or quoted on a stock exchange or interdealer quotation system in such jurisdiction.

**Commission** means Securities and Exchange Commission of the United States of America or other federal agency for the time being administering the U.S. Securities Act;

**Company** means the above-named company;

**Default Rate** means ten per cent per annum;

**Designated Stock Exchanges** means the [Nasdaq Capital Market]<sup>1</sup> in the United States of America for so long as the Company's Shares are there listed and any other stock exchange on which the Company's Shares are listed for trading;

**Designated Stock Exchange Rules** means the relevant code, rules and regulations, as amended, from time to time, applicable as a result of the original and continued listing of any Shares on the Designated Stock Exchanges;

**Directors** means the directors for the time being of the Company and the expression Director shall be construed accordingly;

**Electronic** has the meaning given to that term in the Electronic Transactions Act (Revised) of the Cayman Islands;

**Electronic Record** has the meaning given to that term in the Electronic Transactions Act (Revised) of the Cayman Islands;

**Electronic Signature** has the meaning given to that term in the Electronic Transactions Act (Revised) of the Cayman Islands;

**Fully Paid Up** means:

- (a) in relation to a Share with par value, means that the par value for that Share and any premium payable in respect of the issue of that Share, has been fully paid or credited as paid in money or money's worth; and
- (b) in relation to a Share without par value, means that the agreed issue price for that Share has been fully paid or credited as paid in money or money's worth;

**General Meeting** means a general meeting of the Company duly constituted in accordance with the Articles;

**Independent Director** means a Director who is an independent director as defined in the Designated Stock Exchange Rules as determined by the Board;

**Member** means any person or persons entered on the register of Members from time to time as the holder of a Share;

---

<sup>1</sup> NTD: To confirm before adoption.

**Memorandum** means the memorandum of association of the Company as amended from time to time;

**month** means a calendar month;

**Officer** means a person appointed to hold an office in the Company including a Director, alternate Director or liquidator and excluding the Secretary;

**Ordinary Resolution** means a resolution of a General Meeting passed by a simple majority of Members who (being entitled to do so) vote in person or by proxy at that meeting. The expression includes a unanimous written resolution;

**Ordinary Share** means an ordinary share in the capital of the Company;

**Partly Paid Up** means:

- (a) in relation to a Share with par value, that the par value for that Share and any premium payable in respect of the issue of that Share, has not been fully paid or credited as paid in money or money's worth; and
- (b) in relation to a Share without par value, means that the agreed issue price for that Share has not been fully paid or credited as paid in money or money's worth;

**Secretary** means a person appointed to perform the duties of the secretary of the Company, including a joint, assistant or deputy secretary;

**Share** means a share in the capital of the Company and the expression:

- (a) includes stock (except where a distinction between shares and stock is expressed or implied); and
- (b) where the context permits, also includes a fraction of a Share;

**Special Resolution** means a resolution of a General Meeting or a resolution of a meeting of the holders of any class of Shares in a class meeting duly constituted in accordance with the Articles in each case passed by a majority of not less than two-thirds of Members who (being entitled to do so) vote in person or by proxy at that meeting. The expression includes a unanimous written resolution;

**Treasury Shares** means Shares held in treasury pursuant to the Act and Article 2.12; and

**U.S. Securities Act** means the Securities Act of 1933 of the United States of America, as amended, or any similar federal statute and the rules and regulations of the Commission thereunder, all as the same shall be in effect at the time.



## Interpretation

1.2 In the interpretation of these Articles, the following provisions apply unless the context otherwise requires:

- (a) A reference in these Articles to a statute is a reference to a statute of the Cayman Islands as known by its short title, and includes:
  - (i) any statutory modification, amendment or re-enactment; and
  - (ii) any subordinate legislation or regulations issued under that statute.

Without limitation to the preceding sentence, a reference to a revised Act of the Cayman Islands is taken to be a reference to the revision of that Act in force from time to time as amended from time to time.

- (b) Headings are inserted for convenience only and do not affect the interpretation of these Articles, unless there is ambiguity.
- (c) If a day on which any act, matter or thing is to be done under these Articles is not a Business Day, the act, matter or thing must be done on the next Business Day.
- (d) A word which denotes the singular also denotes the plural, a word which denotes the plural also denotes the singular, and a reference to any gender also denotes the other genders.
- (e) A reference to a **person** includes, as appropriate, a company, trust, partnership, joint venture, association, body corporate or government agency.
- (f) Where a word or phrase is given a defined meaning another part of speech or grammatical form in respect to that word or phrase has a corresponding meaning.
- (g) All references to time are to be calculated by reference to time in the place where the Company's registered office is located.
- (h) The words **written** and **in writing** include all modes of representing or reproducing words in a visible form, but do not include an Electronic Record where the distinction between a document in writing and an Electronic Record is expressed or implied.
- (i) The words **including**, **include** and **in particular** or any similar expression are to be construed without limitation.

1.3 The headings in these Articles are intended for convenience only and shall not affect the interpretation of these Articles.

## **Exclusion of Table A Articles**

1.4 The regulations contained in Table A in the First Schedule of the Act and any other regulations contained in any statute or subordinate legislation are expressly excluded and do not apply to the Company.

## **2 Shares**

### **Power to issue Shares and options, with or without special rights**

2.1 Subject to the provisions of the Act and these Articles about the redemption and purchase of the Shares, the Directors have general and unconditional authority to allot (with or without confirming rights of renunciation), issue, grant options over or otherwise deal with any unissued Shares to such persons, at such times and on such terms and conditions as they may decide. No Share may be issued at a discount except in accordance with the provisions of the Act.

2.2 Without limitation to the preceding Article, the Directors may so deal with the unissued Shares:

- (a) either at a premium or at par; or
- (b) with or without preferred, deferred or other special rights or restrictions, whether in regard to dividend, voting, return of capital or otherwise.

2.3 Without limitation to the two preceding Articles, the Directors may refuse to accept any application for Shares, and may accept any application in whole or in part, for any reason or for no reason.

2.4 The Company may issue rights, options, warrants or convertible securities or securities of similar nature conferring the right upon the holders thereof to subscribe for, purchase or receive any class of Shares or other securities in the Company at such times and on such terms and conditions as the Directors may decide.

2.5 The Company may issue units of securities in the Company, which may be comprised of Shares, rights, options, warrants or convertible securities or securities of similar nature conferring the right upon the holders thereof to subscribe for, purchase or receive any class of Shares or other securities in the Company, on such terms and conditions as the Directors may decide.

2.6 Subject to these Articles, each Share in the Company confers upon the Member:

- (a) the right to one vote at a meeting of the Members of the Company or on any resolution of Members;
- (b) a pro rata right in any dividend paid by the Company; and

- (c) a pro rata right in the distribution of the surplus assets of the Company on its liquidation.

**Power to issue fractions of a Share**

- 2.7 Subject to the Act, the Company may, but shall not otherwise be obliged to, issue fractions of a Share of any class or round up or down fractional holdings of Shares to its nearest whole number. A fraction of a Share shall be subject to and carry the corresponding fraction of liabilities (whether with respect to calls or otherwise), limitations, preferences, privileges, qualifications, restrictions, rights and other attributes of a Share of that class of Shares.

**Power to pay commissions and brokerage fees**

- 2.8 The Company may pay a commission to any person in consideration of that person:

- (a) subscribing or agreeing to subscribe, whether absolutely or conditionally; or  
(b) procuring or agreeing to procure subscriptions, whether absolute or conditional,

for any Shares. That commission may be satisfied by the payment of cash or the allotment of Fully Paid Up or Partly Paid Up Shares or partly in one way and partly in another.

- 2.9 The Company may employ a broker in the issue of its capital and pay such person any proper commission or brokerage.

**Trusts not recognised**

- 2.10 Except as required by Law:

- (a) the Company shall not be bound by or compelled to recognise in any way (even when notified) any equitable, contingent, future or partial interest in any Share, or (except only as is otherwise provided by the Articles) any other rights in respect of any Share other than an absolute right to the entirety thereof in the holder; and  
(b) no person other than the Member shall be recognised by the Company as having any right in a Share.

**Security interests**

- 2.11 Notwithstanding the preceding Article, the Company may (but shall not be obliged to) recognise a security interest of which it has actual notice over Shares. The Company shall not be treated as having recognised any such security interest unless it has so agreed in writing with the secured party.

### **Power to vary class rights**

- 2.12 If the share capital is divided into different classes of Shares then, unless the terms on which a class of Shares was issued state otherwise, the rights attaching to a class of Shares may only be varied if one of the following applies:
- (a) the Members holding not less than two-thirds of the issued Shares of that class consent in writing to the variation; or
  - (b) the variation is made with the sanction of a Special Resolution passed at a separate General Meeting of the Members holding the issued Shares of that class.
- 2.13 For the purpose of Article 2.12(b), all the provisions of these Articles relating to General Meetings apply, mutatis mutandis, to every such separate meeting except that:
- (a) the necessary quorum shall be one or more persons holding, or representing by proxy, not less than one third of the issued Shares of the class; and
  - (b) any Member holding issued Shares of the class, present in person or by proxy or, in the case of a corporate Member, by its duly authorised representative, may demand a poll.

### **Effect of new Share issue on existing class rights**

- 2.14 Unless the terms on which a class of Shares was issued state otherwise, the rights conferred on the Member holding Shares of any class shall not be deemed to be varied by the creation or issue of further Shares ranking *pari passu* with the existing Shares of that class.

### **Capital contributions without issue of further Shares**

- 2.15 With the consent of a Member, the Directors may accept a voluntary contribution to the capital of the Company from that Member without issuing Shares in consideration for that contribution. In that event, the contribution shall be dealt with in the following manner:
- (a) It shall be treated as if it were a share premium.
  - (b) Unless the Member agrees otherwise:
    - (i) if the Member holds Shares in a single class of Shares - it shall be credited to the share premium account for that class of Shares;
    - (ii) if the Member holds Shares of more than one class - it shall be credited rateably to the share premium accounts for those classes of Shares (in the proportion that the sum of the issue prices for each class of Shares that the Member holds bears to the total issue prices for all classes of Shares that the Member holds).

- (c) It shall be subject to the provisions of the Act and these Articles applicable to share premiums.

**No bearer Shares or warrants**

2.16 The Company shall not issue Shares or warrants to bearers.

**Treasury Shares**

2.17 Shares that the Company purchases, redeems or acquires by way of surrender in accordance with the Act shall be held as Treasury Shares and not treated as cancelled if:

- (a) the Directors so determine prior to the purchase, redemption or surrender of those shares; and
- (b) the relevant provisions of the Memorandum and Articles and the Act are otherwise complied with.

**Rights attaching to Treasury Shares and related matters**

2.18 No dividend may be declared or paid, and no other distribution (whether in cash or otherwise) of the Company's assets (including any distribution of assets to Members on a winding up) may be made to the Company in respect of a Treasury Share.

2.19 The Company shall be entered in the register of Members as the holder of the Treasury Shares. However:

- (a) the Company shall not be treated as a Member for any purpose and shall not exercise any right in respect of the Treasury Shares, and any purported exercise of such a right shall be void; and
- (b) a Treasury Share shall not be voted, directly or indirectly, at any meeting of the Company and shall not be counted in determining the total number of issued shares at any given time, whether for the purposes of these Articles or the Act.

2.20 Nothing in Article 2.19 prevents an allotment of Shares as Fully Paid Up bonus shares in respect of a Treasury Share and Shares allotted as Fully Paid Up bonus shares in respect of a Treasury Share shall be treated as Treasury Shares.

2.21 Treasury Shares may be disposed of by the Company in accordance with the Act and otherwise on such terms and conditions as the Directors determine.

**Register of Members**

2.22 The Company shall keep or cause to be kept a register of Members as required by the Act and the Directors may cause the Company to maintain one or more branch registers as contemplated by the Act, provided that where the Company is maintaining one or more branch registers, the Directors shall ensure that a duplicate of each branch register is kept with the Company's principal register of Members and updated within such number of days of any amendment having been made to such branch register as may be required by the Act.

- 2.23 For as long as the Shares are listed on any Designated Stock Exchange, the title to Shares may be evidenced and transferred in accordance with the laws applicable to the rules and regulations of the Designated Stock Exchange and, for these purposes, the Register of Members may be maintained in accordance with Section 40B of the Act.

### **Annual Return**

- 2.24 The Directors in each calendar year shall prepare or cause to be prepared an annual return and declaration setting forth the particulars required by the Act and shall deliver a copy thereof to the registrar of companies for the Cayman Islands.

## **3 Share certificates**

### **Issue of share certificates**

- 3.1 A Member shall only be entitled to a share certificate if the Directors resolve that share certificates shall be issued. Share certificates representing Shares, if any, shall be in such form as the Directors may determine. If the Directors resolve that share certificates shall be issued, upon being entered in the register of Members as the holder of a Share, the Directors may issue to any Member:
- (a) without payment, one certificate for all the Shares of each class held by that Member (and, upon transferring a part of the Member's holding of Shares of any class, to a certificate for the balance of that holding); and
  - (b) upon payment of such reasonable sum as the Directors may determine for every certificate after the first, several certificates each for one or more of that Member's Shares.
- 3.2 Every certificate shall specify the number, class and distinguishing numbers (if any) of the Shares to which it relates and whether they are Fully Paid Up or Partly Paid Up. A certificate may be executed under seal or executed in such other manner as the Directors determine.
- 3.3 Every certificate shall bear legends required under the applicable laws, including the U.S. Securities Act.
- 3.4 The Company shall not be bound to issue more than one certificate for Shares held jointly by several persons and delivery of a certificate for a Share to one joint holder shall be a sufficient delivery to all of them.

### **Renewal of lost or damaged share certificates**

3.5 If a share certificate is defaced, worn-out, lost or destroyed, it may be renewed on such terms (if any) as to:

- (a) evidence;
- (b) indemnity;
- (c) payment of the expenses reasonably incurred by the Company in investigating the evidence; and
- (d) payment of a reasonable fee, if any for issuing a replacement share certificate,

as the Directors may determine, and (in the case of defacement or wearing-out) on delivery to the Company of the old certificate.

## **4 Lien on Shares**

### **Nature and scope of lien**

4.1 The Company has a first and paramount lien on all Shares (whether Fully Paid Up or not) registered in the name of a Member (whether solely or jointly with others). The lien is for all monies payable to the Company by the Member or the Member's estate:

- (a) either alone or jointly with any other person, whether or not that other person is a Member; and
- (b) whether or not those monies are presently payable.

4.2 At any time the Board may declare any Share to be wholly or partly exempt from the provisions of this Article.

### **Company may sell Shares to satisfy lien**

4.3 The Company may sell any Shares over which it has a lien if all of the following conditions are met:

- (a) the sum in respect of which the lien exists is presently payable;
- (b) the Company gives notice to the Member holding the Share (or to the person entitled to it in consequence of the death or bankruptcy of that Member) demanding payment and stating that if the notice is not complied with the Shares may be sold; and
- (c) that sum is not paid within fourteen Clear Days after that notice is deemed to be given under these Articles,

and Shares to which this Article 4.3 applies shall be referred to as Lien Default Shares.

4.4 The Lien Default Shares may be sold in such manner as the Board determines.

4.5 To the maximum extent permitted by law, the Directors shall incur no personal liability to the Member concerned in respect of the sale.

**Authority to execute instrument of transfer**

4.6 To give effect to a sale, the Directors may authorise any person to execute an instrument of transfer of the Lien Default Shares sold to, or in accordance with the directions of, the purchaser.

4.7 The title of the transferee of the Lien Default Shares shall not be affected by any irregularity or invalidity in the proceedings in respect of the sale.

**Consequences of sale of Shares to satisfy lien**

4.8 On a sale pursuant to the preceding Articles:

- (a) the name of the Member concerned shall be removed from the register of Members as the holder of those Lien Default Shares; and
- (b) that person shall deliver to the Company for cancellation the certificate (if any) for those Lien Default Shares.

4.9 Notwithstanding the provisions of Article 4.8, such person shall remain liable to the Company for all monies which, at the date of sale, were presently payable by such person to the Company in respect of those Lien Default Shares. That person shall also be liable to pay interest on those monies from the date of sale until payment at the rate at which interest was payable before that sale or, failing that, at the Default Rate. The Board may waive payment wholly or in part or enforce payment without any allowance for the value of the Lien Default Shares at the time of sale or for any consideration received on their disposal.

**Application of proceeds of sale**

4.10 The net proceeds of the sale, after payment of the costs, shall be applied in payment of so much of the sum for which the lien exists as is presently payable. Any residue shall be paid to the person whose Lien Default Shares have been sold:

- (a) if no certificate for the Lien Default Shares was issued, at the date of the sale; or
- (b) if a certificate for the Lien Default Shares was issued, upon surrender to the Company of that certificate for cancellation

but, in either case, subject to the Company retaining a like lien for all sums not presently payable as existed on the Lien Default Shares before the sale.



## **5 Calls on Shares and forfeiture**

### **Power to make calls and effect of calls**

- 5.1 Subject to the terms of allotment, the Board may make calls on the Members in respect of any monies unpaid on their Shares including any premium. The call may provide for payment to be by instalments. Subject to receiving at least 14 Clear Days' notice specifying when and where payment is to be made, each Member shall pay to the Company the amount called on such Member's Shares as required by the notice.
- 5.2 Before receipt by the Company of any sum due under a call, that call may be revoked in whole or in part and payment of a call may be postponed in whole or in part. Where a call is to be paid in instalments, the Company may revoke the call in respect of all or any remaining instalments in whole or in part and may postpone payment of all or any of the remaining instalments in whole or in part.
- 5.3 A Member on whom a call is made shall remain liable for that call notwithstanding the subsequent transfer of the Shares in respect of which the call was made. A person shall not be liable for calls made after such person is no longer registered as Member in respect of those Shares.

### **Time when call made**

- 5.4 A call shall be deemed to have been made at the time when the resolution of the Directors authorising the call was passed.

### **Liability of joint holders**

- 5.5 Members registered as the joint holders of a Share shall be jointly and severally liable to pay all calls in respect of the Share.

### **Interest on unpaid calls**

- 5.6 If a call remains unpaid after it has become due and payable the person from whom it is due and payable shall pay interest on the amount unpaid from the day it became due and payable until it is paid:
- (a) at the rate fixed by the terms of allotment of the Share or in the notice of the call; or
  - (b) if no rate is fixed, at the Default Rate.

The Directors may waive payment of the interest wholly or in part.

### **Deemed calls**

- 5.7 Any amount payable in respect of a Share, whether on allotment or on a fixed date or otherwise, shall be deemed to be payable as a call. If the amount is not paid when due the provisions of these Articles shall apply as if the amount had become due and payable by virtue of a call.

**Power to accept early payment**

- 5.8 The Company may accept from a Member the whole or a part of the amount remaining unpaid on Shares held by such person although no part of that amount has been called up.

**Power to make different arrangements at time of issue of Shares**

- 5.9 Subject to the terms of allotment, the Directors may make arrangements on the issue of Shares to distinguish between Members in the amounts and times of payment of calls on their Shares.

**Notice of default**

- 5.10 If a call remains unpaid after it has become due and payable the Directors may give to the person from whom it is due not less than 14 Clear Days' notice requiring payment of:

- (a) the amount unpaid;
- (b) any interest which may have accrued;
- (c) any expenses which have been incurred by the Company due to that person's default.

- 5.11 The notice shall state the following:

- (a) the place where payment is to be made; and
- (b) a warning that if the notice is not complied with the Shares in respect of which the call is made will be liable to be forfeited.

**Forfeiture or surrender of Shares**

- 5.12 If the notice given pursuant to Article 5.10 is not complied with, the Directors may, before the payment required by the notice has been received, resolve that any Share the subject of that notice be forfeited. The forfeiture shall include all dividends or other monies payable in respect of the forfeited Share and not paid before the forfeiture. Despite the foregoing, the Board may determine that any Share the subject of that notice be accepted by the Company as surrendered by the Member holding that Share in lieu of forfeiture.

- 5.13 The Directors may accept the surrender for no consideration of any Fully Paid Up Share.

**Disposal of forfeited or surrendered Share and power to cancel forfeiture or surrender**

- 5.14 A forfeited or surrendered Share may be sold, re-allotted or otherwise disposed of on such terms and in such manner as the Board determine either to the former Member who held that Share or to any other person. The forfeiture or surrender may be cancelled on such terms as the Directors think fit at any time before a sale, re-allotment or other disposition. Where, for the purposes of its disposal, a forfeited or surrendered Share is to be transferred to any person, the Directors may authorise some person to execute an instrument of transfer of the Share to the transferee.

**Effect of forfeiture or surrender on former Member**

5.15 On forfeiture or surrender:

- (a) the name of the Member concerned shall be removed from the register of Members as the holder of those Shares and that person shall cease to be a Member in respect of those Shares; and
- (b) that person shall surrender to the Company for cancellation the certificate (if any) for the forfeited or surrendered Shares.

5.16 Despite the forfeiture or surrender of such Member's Shares, that person shall remain liable to the Company for all monies which at the date of forfeiture or surrender were presently payable by such person to the Company in respect of those Shares together with:

- (a) all expenses; and
- (b) interest from the date of forfeiture or surrender until payment:
  - (i) at the rate of which interest was payable on those monies before forfeiture; or
  - (ii) if no interest was so payable, at the Default Rate.

The Directors, however, may waive payment wholly or in part.

**Evidence of forfeiture or surrender**

5.17 A declaration, whether statutory or under oath, made by a Director or the Secretary shall be conclusive evidence of the following matters stated in it as against all persons claiming to be entitled to forfeited Shares:

- (a) that the person making the declaration is a Director or Secretary of the Company, and
- (b) that the particular Shares have been forfeited or surrendered on a particular date.

Subject to the execution of an instrument of transfer, if necessary, the declaration shall constitute good title to the Shares.

## **Sale of forfeited or surrendered Shares**

- 5.18 Any person to whom the forfeited or surrendered Shares are disposed of shall not be bound to see to the application of the consideration, if any, of those Shares nor shall such Member's title to the Shares be affected by any irregularity in, or invalidity of the proceedings in respect of, the forfeiture, surrender or disposal of those Shares.

## **6 Transfer of Shares**

### **Right to transfer**

- 6.1 The instrument of transfer of any Share shall be in writing and in any usual or common form or such other form as the Directors may, in their absolute discretion, approve and be executed by or on behalf of the transferor and if in respect of a nil or Partly Paid Up Share, or if so required by the Directors, shall also be executed on behalf of the transferee and shall be accompanied by the certificate (if any) of the Shares to which it relates and such other evidence as the Directors may reasonably require to show the right of the transferor to make the transfer. The transferor shall be deemed to remain a Member until the name of the transferee is entered in the register of Members in respect of the relevant Shares.
- 6.2 The Directors may in their absolute discretion decline to register any transfer of Shares which is not Fully Paid Up or on which the Company has a lien.
- 6.3 The Directors may also, but are not required to, decline to register any transfer of any Share unless:
- (a) the instrument of transfer is lodged with the Company, accompanied by the certificate (if any) for the Shares to which it relates and such other evidence as the Board may reasonably require to show the right of the transferor to make the transfer;
  - (b) the instrument of transfer is in respect of only one class of Shares;
  - (c) the instrument of transfer is properly stamped, if required;
  - (d) in the case of a transfer to joint holders, the number of joint holders to whom the Share is to be transferred does not exceed four;
  - (e) the Shares transferred are Fully Paid Up and free of any lien in favour of the Company; and
  - (f) any applicable fee of such maximum sum as the Designated Stock Exchanges may determine to be payable, or such lesser sum as the Board may from time to time require, related to the transfer is paid to the Company.

### **Suspension of transfers**

- 6.4 The registration of transfers may, on 14 days' notice being given by advertisement in such one or more newspapers or by electronic means, be suspended and the register of Members closed at such times and for such periods as the Directors may, in their absolute discretion, from time to time determine, provided always that such registration of transfer shall not be suspended nor the register of Members closed for more than 30 days in any year.

### **Company may retain instrument of transfer**

- 6.5 The Company shall be entitled to retain all instruments of transfer that are registered.

### **Notice of refusal to register**

- 6.6 If the Directors refuse to register a transfer of any Shares, they shall within three months after the date on which the instrument of transfer was lodged with the Company send to each of the transferor and the transferee notice of the refusal.

## **7 Transmission of Shares**

### **Persons entitled on death of a Member**

- 7.1 If a Member dies, the only persons recognised by the Company as having any title to the deceased Members' interest are the following:
- (a) where the deceased Member was a joint holder, the survivor or survivors; and
  - (b) where the deceased Member was a sole holder, that Member's personal representative or representatives.
- 7.2 Nothing in these Articles shall release the deceased Member's estate from any liability in respect of any Share, whether the deceased was a sole holder or a joint holder.

### **Registration of transfer of a Share following death or bankruptcy**

- 7.3 A person becoming entitled to a Share in consequence of the death or bankruptcy of a Member may elect to do either of the following:
- (a) to become the holder of the Share; or
  - (b) to transfer the Share to another person.
- 7.4 That person must produce such evidence of his/her/its entitlement as the Directors may properly require.

- 7.5 If the person elects to become the holder of the Share, such person must give notice to the Company to that effect. For the purposes of these Articles, that notice shall be treated as though it were an executed instrument of transfer.
- 7.6 If the person elects to transfer the Share to another person then:
- (a) if the Share is Fully Paid Up, the transferor must execute an instrument of transfer; and
  - (b) if the Share is nil or Partly Paid Up, the transferor and the transferee must execute an instrument of transfer.
- 7.7 All the Articles relating to the transfer of Shares shall apply to the notice or, as appropriate, the instrument of transfer.

#### **Indemnity**

- 7.8 A person registered as a Member by reason of the death or bankruptcy of another Member shall indemnify the Company and the Directors against any loss or damage suffered by the Company or the Directors as a result of that registration.

#### **Rights of person entitled to a Share following death or bankruptcy**

- 7.9 A person becoming entitled to a Share by reason of the death or bankruptcy of a Member shall have the rights to which such person would be entitled if such person were registered as the holder of the Share. But, until such person is registered as Member in respect of the Share, such person shall not be entitled to attend or vote at any meeting of the Company or at any separate meeting of the holders of that class of Shares.

### **8 Alteration of capital**

#### **Increasing, consolidating, converting, dividing and cancelling share capital**

- 8.1 To the fullest extent permitted by the Act, the Company may by Ordinary Resolution do any of the following and amend its Memorandum for that purpose:
- (a) increase its share capital by new Shares of the amount fixed by that Ordinary Resolution and with the attached rights, priorities and privileges set out in that Ordinary Resolution;
  - (b) consolidate and divide all or any of its share capital into Shares of larger amount than its existing Shares;
  - (c) convert all or any of its Paid Up Shares into stock, and reconvert that stock into Paid Up Shares of any denomination;

- (d) sub-divide its Shares or any of them into Shares of an amount smaller than that fixed by the Memorandum, so, however, that in the sub-division, the proportion between the amount paid and the amount, if any, unpaid on each reduced Share shall be the same as it was in case of the Share from which the reduced Share is derived; and
- (e) cancel Shares which, at the date of the passing of that Ordinary Resolution, have not been taken or agreed to be taken by any person, and diminish the amount of its share capital by the amount of the Shares so cancelled or, in the case of Shares without nominal par value, diminish the number of Shares into which its capital is divided.

#### **Dealing with fractions resulting from consolidation of Shares**

- 8.2 Whenever, as a result of a consolidation of Shares, any Members would become entitled to fractions of a Share the Directors may on behalf of those Members deal with the fractions as it thinks fit, including (without limitation):
- (a) sell the Shares representing the fractions for the best price reasonably obtainable to any person (including, subject to the provisions of the Act, the Company); and
  - (b) distribute the net proceeds in due proportion among those Members.
- 8.3 For the purposes of Article 8.2, the Directors may authorise some person to execute an instrument of transfer of the Shares to, in accordance with the directions of, the purchaser. The transferee shall not be bound to see to the application of the purchase money nor shall the transferee's title to the Shares be affected by any irregularity in, or invalidity of, the proceedings in respect of the sale.

#### **Reducing share capital**

- 8.4 Subject to the Act and to any rights for the time being conferred on the Members holding a particular class of Shares, the Company may, by Special Resolution, reduce its share capital in any way.

### **9 Redemption and purchase of own Shares**

#### **Power to issue redeemable Shares and to purchase own Shares**

- 9.1 Subject to the Act and to any rights for the time being conferred on the Members holding a particular class of Shares, and, where applicable, the rules and regulations of the Designated Stock Exchange, and/or other competent regulatory authority or otherwise under applicable law, the Company may by its Directors:
- (a) issue Shares that are to be redeemed or liable to be redeemed, at the option of the Company or the Member holding those redeemable Shares, on the terms and in the manner its Directors determine before the issue of those Shares;

- (b) with the consent by Special Resolution of the Members holding Shares of a particular class, vary the rights attaching to that class of Shares so as to provide that those Shares are to be redeemed or are liable to be redeemed at the option of the Company on the terms and in the manner which the Directors determine at the time of such variation; and
- (c) purchase all or any of its own Shares of any class including any redeemable Shares on the terms and in the manner which the Directors determine at the time of such purchase.

The Company may make a payment in respect of the redemption or purchase of its own Shares in any manner authorised by the Act, including out of any combination of the following: capital, its profits and the proceeds of a fresh issue of Shares.

**Power to pay for redemption or purchase in cash or in specie**

- 9.2 When making a payment in respect of the redemption or purchase of Shares, the Directors may make the payment in cash or *in specie* (or partly in one and partly in the other) if so authorised by the terms of the allotment of those Shares or by the terms applying to those Shares in accordance with Article 9.1, or otherwise by agreement with the Member holding those Shares.

**Effect of redemption or purchase of a Share**

- 9.3 Upon the date of redemption or purchase of a Share:

- (a) the Member holding that Share shall cease to be entitled to any rights in respect of the Share other than the right to receive:
  - (i) the price for the Share; and
  - (ii) any dividend declared in respect of the Share prior to the date of redemption or purchase;
- (b) the Member's name shall be removed from the register of Members with respect to the Share; and
- (c) the Share shall be cancelled or held as a Treasury Share, as the Directors may determine.

- 9.4 For the purpose of Article 9.3, the date of redemption or purchase is the date when the Member's name is removed from the register of Members with respect to the Shares the subject of the redemption or purchase.



## **10 Meetings of Members**

### **Annual and extraordinary General Meetings**

10.1 The Company may, but shall not (unless required by the Designated Stock Exchange Rules) be obligated to, in each year hold a General Meeting as an annual General Meeting, which, if held, shall be convened by the Board, in accordance with these Articles.

10.2 All General Meetings other than annual General Meetings shall be called extraordinary General Meetings.

### **Power to call meetings**

10.3 The Directors may call a General Meeting at any time.

10.4 If there are insufficient Directors to constitute a quorum and the remaining Directors are unable to agree on the appointment of additional Directors, the Directors must call a General Meeting for the purpose of appointing additional Directors.

10.5 The Directors must also call a General Meeting if requisitioned in the manner set out in the next two Articles.

10.6 The requisition must be in writing and given by one or more Members who together hold at least ten per cent of the rights to vote at such General Meeting.

10.7 The requisition must also:

- (a) specify the purpose of the meeting.
- (b) be signed by or on behalf of each requisitioner (and for this purpose each joint holder shall be obliged to sign). The requisition may consist of several documents in like form signed by one or more of the requisitioners; and
- (c) be delivered in accordance with the notice provisions.

10.8 Should the Directors fail to call a General Meeting within 21 Clear Days' from the date of receipt of a requisition, the requisitioners or any of them may call a General Meeting within three months after the end of that period.

10.9 Without limitation to the foregoing, if there are insufficient Directors to constitute a quorum and the remaining Directors are unable to agree on the appointment of additional Directors, any one or more Members who together hold at least ten per cent of the rights to vote at a General Meeting may call a General Meeting for the purpose of considering the business specified in the notice of meeting which shall include as an item of business the appointment of additional Directors.

- 10.10 Members seeking to bring business before the annual General Meeting or to nominate candidates for election as Directors at the annual General Meeting must deliver notice to the principal executive offices of the Company not later than the close of business on the 90th day nor earlier than the close of business on the 120th day prior to the scheduled date of the annual General Meeting.

**Content of notice**

- 10.11 Notice of a General Meeting shall specify each of the following:
- (a) the place, the date and the hour of the meeting;
  - (b) if the meeting is to be held in two or more places, the technology that will be used to facilitate the meeting;
  - (c) subject to paragraph (d) and the requirements of (to the extent applicable) the Designated Stock Exchange Rules, the general nature of the business to be transacted; and
  - (d) if a resolution is proposed as a Special Resolution, the text of that resolution.
- 10.12 In each notice there shall appear with reasonable prominence the following statements:
- (a) that a Member who is entitled to attend and vote is entitled to appoint one or more proxies to attend and vote instead of that Member; and
  - (b) that a proxyholder need not be a Member.

**Period of notice**

- 10.13 At least twenty-one Clear Days' notice of an annual General Meeting must be given to Members. For any other General Meeting, at least fourteen Clear Days' notice must be given to Members.
- 10.14 Subject to the Act, a meeting may be convened on shorter notice, subject to the Act with the consent of the Member or Members who, individually or collectively, hold at least ninety per cent of the voting rights of all those who have a right to vote at that meeting.

**Persons entitled to receive notice**

- 10.15 Subject to the provisions of these Articles and to any restrictions imposed on any Shares, the notice shall be given to the following people:
- (a) the Members
  - (b) persons entitled to a Share in consequence of the death or bankruptcy of a Member; and

(c) the Directors.

10.16 The Board may determine that the Members entitled to receive notice of a meeting are those persons entered on the register of Members at the close of business on a day determined by the Board.

**Accidental omission to give notice or non-receipt of notice**

10.17 Proceedings at a meeting shall not be invalidated by the following:

- (a) an accidental failure to give notice of the meeting to any person entitled to notice; or
- (b) non-receipt of notice of the meeting by any person entitled to notice.

10.18 In addition, where a notice of meeting is published on a website proceedings at the meeting shall not be invalidated merely because it is accidentally published:

- (a) in a different place on the website; or
- (b) for part only of the period from the date of the notification until the conclusion of the meeting to which the notice relates.

**11 Proceedings at meetings of Members**

**Quorum**

11.1 Save as provided in the following Article, no business shall be transacted at any meeting unless a quorum is present in person or by proxy. A quorum is as follows:

- (a) if the Company has only one Member: that Member;
- (b) if the Company has more than one Member: one or more Members holding Shares that represent not less than one-third of the outstanding Shares carrying the right to vote at such General Meeting.

**Lack of quorum**

11.2 If a quorum is not present within fifteen minutes of the time appointed for the meeting, or if at any time during the meeting it becomes inquorate, then the following provisions apply:

- (a) If the meeting was requisitioned by Members, it shall be cancelled.
- (b) In any other case, the meeting shall stand adjourned to the same time and place seven days hence, or to such other time or place as is determined by the Directors. If a quorum is not present within fifteen minutes of the time appointed for the adjourned meeting, then the Members present in person or by proxy shall constitute a quorum.

### **Use of technology**

- 11.3 A person may participate in a general meeting through the medium of conference telephone, video or any other form of communications equipment providing all persons participating in a meeting are able to hear and speak to each other throughout the meeting. A person participating in this way is deemed to be present in person at the meeting.

### **Chairman**

- 11.4 The chairman of a General Meeting shall be the chairman of the Board or such other Director as the Directors have nominated to chair Board meetings in the absence of the chairman of the Board. Absent any such person being present within fifteen minutes of the time appointed for the meeting, the Directors present shall elect one of their number to chair the meeting.
- 11.5 If no Director is present within fifteen minutes of the time appointed for the meeting, or if no Director is willing to act as chairman, the Members present in person or by proxy and entitled to vote shall choose one of their number to chair the meeting.

### **Right of a Director to attend and speak**

- 11.6 Even if a Director is not a Member, he/she shall be entitled to attend and speak at any General Meeting and at any separate meeting of Members holding a particular class of Shares.

### **Accommodation of Members at meeting**

- 11.7 If it appears to the chairman of the meeting that the meeting place specified in the notice convening the meeting is inadequate to accommodate all Members entitled and wishing to attend, the meeting will be duly constituted and its proceedings valid if the chairman is satisfied that adequate facilities are available to ensure that a Member who is unable to be accommodated is able (whether at the meeting place or elsewhere):
- (a) to participate in the business for which the meeting has been convened;
  - (b) to hear and see all persons present who speak (whether by the use of microphones, loud-speakers, audio-visual communications equipment or otherwise); and
  - (c) to be heard and seen by all other persons present in the same way.

### **Security**

- 11.8 In addition to any measures which the Board may be required to take due to the location or venue of the meeting, the Board may make any arrangement and impose any restriction it considers appropriate and reasonable in the circumstances to ensure the security of a meeting including, without limitation, the searching of any person attending the meeting and the imposing of restrictions on the items of personal property that may be taken into the meeting place. The Board may refuse entry to, or eject from, a meeting a person who refuses to comply with any such arrangements or restrictions.

**Adjournment**

- 11.9 The chairman may at any time adjourn a meeting with the consent of the Members constituting a quorum. The chairman must adjourn the meeting if so directed by the meeting. No business, however, can be transacted at an adjourned meeting other than business which might properly have been transacted at the original meeting.
- 11.10 Should a meeting be adjourned for more than 7 Clear Days, whether because of a lack of quorum or otherwise, Members shall be given at least seven Clear Days' notice of the date, time and place of the adjourned meeting and the general nature of the business to be transacted. Otherwise it shall not be necessary to give any notice of the adjournment.

**Method of voting**

- 11.11 A resolution put to the vote of the meeting shall be decided on a poll.

**Taking of a poll**

- 11.12 A poll demanded on the question of adjournment shall be taken immediately.
- 11.13 A poll demanded on any other question shall be taken either immediately or at an adjourned meeting at such time and place as the chairman directs, not being more than thirty Clear Days after the poll was demanded.
- 11.14 The demand for a poll shall not prevent the meeting continuing to transact any business other than the question on which the poll was demanded.
- 11.15 A poll shall be taken in such manner as the chairman directs. He/she may appoint scrutineers (who need not be Members) and fix a place and time for declaring the result of the poll. If, through the aid of technology, the meeting is held in more than place, the chairman may appoint scrutineers in more than place; but if he/she considers that the poll cannot be effectively monitored at that meeting, the chairman shall adjourn the holding of the poll to a date, place and time when that can occur.

**Chairman's casting vote**

- 11.16 In the case of an equality of votes, the chairman of the meeting shall be entitled to a second or casting vote.

### **Amendments to resolutions**

11.17 An Ordinary Resolution to be proposed at a General Meeting may be amended by Ordinary Resolution if:

- (a) not less than 48 hours before the meeting is to take place (or such later time as the chairman of the meeting may determine), notice of the proposed amendment is given to the Company in writing by a Member entitled to vote at that meeting; and
- (b) the proposed amendment does not, in the reasonable opinion of the chairman of the meeting, materially alter the scope of the resolution.

11.18 A Special Resolution to be proposed at a General Meeting may be amended by Ordinary Resolution, if:

- (a) the chairman of the meeting proposes the amendment at the General Meeting at which the resolution is to be proposed, and
- (b) the amendment does not go beyond what the chairman considers is necessary to correct a grammatical or other non-substantive error in the resolution.

11.19 If the chairman of the meeting, acting in good faith, wrongly decides that an amendment to a resolution is out of order, the chairman's error does not invalidate the vote on that resolution.

### **Written resolutions**

11.20 Members may pass a resolution in writing without holding a meeting if the following conditions are met:

- (a) all Members entitled to vote are given notice of the resolution as if the same were being proposed at a meeting of Members;
- (b) all Members entitled so to vote;
  - (i) sign a document; or
  - (ii) sign several documents in the like form each signed by one or more of those Members; and
- (c) the signed document or documents is or are delivered to the Company, including, if the Company so nominates, by delivery of an Electronic Record by Electronic means to the address specified for that purpose.
- (d) Such written resolution shall be as effective as if it had been passed at a meeting of the Members entitled to vote duly convened and held.

11.21 If a written resolution is described as a Special Resolution or as an Ordinary Resolution, it has effect accordingly.

11.22 The Directors may determine the manner in which written resolutions shall be put to Members. In particular, they may provide, in the form of any written resolution, for each Member to indicate, out of the number of votes the Member would have been entitled to cast at a meeting to consider the resolution, how many votes such person wishes to cast in favour of the resolution and how many against the resolution or to be treated as abstentions. The result of any such written resolution shall be determined on the same basis as on a poll.

### **Sole-Member Company**

- 11.23 If the Company has only one Member, and the Member records in writing such Member's decision on a question, that record shall constitute both the passing of a resolution and the minute of it.

### **12 Voting rights of Members**

#### **Right to vote**

- 12.1 Unless their Shares carry no right to vote, or unless a call or other amount presently payable has not been paid, all Members are entitled to vote at a General Meeting, and all Members holding Shares of a particular class of Shares are entitled to vote at a meeting of the holders of that class of Shares.
- 12.2 Members may vote in person or by proxy.
- 12.3 On a poll a Member shall have one vote for each Share such person holds, unless any Share carries special voting rights.
- 12.4 No Member is bound to vote on such Member's Shares or any of them; nor is a Member bound to vote each of such Member's Shares in the same way.

#### **Rights of joint holders**

- 12.5 If Shares are held jointly, only one of the joint holders may vote. If more than one of the joint holders tenders a vote, the vote of the holder whose name in respect of those Shares appears first in the register of Members shall be accepted to the exclusion of the votes of the other joint holder.

#### **Representation of corporate Members**

- 12.6 Save where otherwise provided, a corporate Member must act by a duly authorised representative.
- 12.7 A corporate Member wishing to act by a duly authorised representative must identify that person to the Company by notice in writing.
- 12.8 The authorisation may be for any period of time, and must be delivered to the Company before the commencement of the meeting at which it is first used.
- 12.9 The Directors of the Company may require the production of any evidence which they consider necessary to determine the validity of the notice.

- 12.10 Where a duly authorised representative is present at a meeting that Member is deemed to be present in person; and the acts of the duly authorised representative are personal acts of that Member.
- 12.11 A corporate Member may revoke the appointment of a duly authorised representative at any time by notice to the Company; but such revocation will not affect the validity of any acts carried out by the duly authorised representative before the Directors of the Company had actual notice of the revocation.
- 12.12 If a clearing house (or its nominee(s)), being a corporation, is a Member, it may authorise such persons as it sees fit to act as its representative at any meeting of the Company or at any meeting of any class of Members provided that the authorisation shall specify the number and class of Shares in respect of which each such representative is so authorised. Each person so authorised under the provisions of this Article shall be deemed to have been duly authorised without further evidence of the facts and be entitled to exercise the same rights and powers on behalf of the clearing house (or its nominee(s)) as if such person was the registered holder of such Shares held by the clearing house (or its nominee(s)).

#### **Member with mental disorder**

- 12.13 A Member in respect of whom an order has been made by any court having jurisdiction (whether in the Cayman Islands or elsewhere) in matters concerning mental disorder may vote, by that Member's receiver, *curator bonis* or other person authorised in that behalf appointed by that court.
- 12.14 For the purpose of the preceding Article, evidence to the satisfaction of the Directors of the authority of the person claiming to exercise the right to vote must be received not less than 24 hours before holding the relevant meeting or the adjourned meeting in any manner specified for the delivery of forms of appointment of a proxy, whether in writing or by Electronic means. In default, the right to vote shall not be exercisable.

#### **Objections to admissibility of votes**

- 12.15 An objection to the validity of a person's vote may only be raised at the meeting or at the adjourned meeting at which the vote is sought to be tendered. Any objection duly made shall be referred to the chairman whose decision shall be final and conclusive.

#### **Form of proxy**

- 12.16 An instrument appointing a proxy shall be in any common form or in any other form approved by the Directors.
- 12.17 The instrument must be in writing and signed in one of the following ways:
- (a) by the Member; or
  - (b) by the Member's authorised attorney; or



(c) if the Member is a corporation or other body corporate, under seal or signed by an authorised officer, secretary or attorney.

If the Directors so resolve, the Company may accept an Electronic Record of that instrument delivered in the manner specified below and otherwise satisfying the Articles about authentication of Electronic Records.

- 12.18 The Directors may require the production of any evidence which they consider necessary to determine the validity of any appointment of a proxy.
- 12.19 A Member may revoke the appointment of a proxy at any time by notice to the Company duly signed in accordance with Article 12.17.
- 12.20 No revocation by a Member of the appointment of a proxy made in accordance with Article 12.19 will affect the validity of any acts carried out by the relevant proxy before the Directors of the Company had actual notice of the revocation.

**How and when proxy is to be delivered**

- 12.21 Subject to the following Articles, the Directors may, in the notice convening any meeting or adjourned meeting, or in an instrument of proxy sent out by the Company, specify the manner by which the instrument appointing a proxy shall be deposited and the place and the time (being not later than the time appointed for the commencement of the meeting or adjourned meeting to which the proxy relates) at which the instrument appointing a proxy shall be deposited. In the absence of any such direction from the Directors in the notice convening any meeting or adjourned meeting or in an instrument of proxy sent out by the Company, the form of appointment of a proxy and any authority under which it is signed (or a copy of the authority certified notially or in any other way approved by the Directors) must be delivered so that it is received by the Company before the time for holding the meeting or adjourned meeting at which the person named in the form of appointment of proxy proposes to vote. They must be delivered in either of the following ways:
- (a) In the case of an instrument in writing, it must be left at or sent by post:
- (i) to the registered office of the Company; or
  - (ii) to such other place specified in the notice convening the meeting or in any form of appointment of proxy sent out by the Company in relation to the meeting.
- (b) If, pursuant to the notice provisions, a notice may be given to the Company in an Electronic Record, an Electronic Record of an appointment of a proxy must be sent to the address specified pursuant to those provisions unless another address for that purpose is specified:
- (i) in the notice convening the meeting; or

- (ii) in any form of appointment of a proxy sent out by the Company in relation to the meeting; or
  - (iii) in any invitation to appoint a proxy issued by the Company in relation to the meeting.
- (c) Notwithstanding Article 12.21(a) and Article 12.21(b), the chairman of the Company may, in any event at his/her discretion, direct that an instrument of proxy shall be deemed to have been duly deposited.

12.22 Where a poll is taken:

- (a) if it is taken more than seven Clear Days after it is demanded, the form of appointment of a proxy and any accompanying authority (or an Electronic Record of the same) must be delivered in accordance with Article 12.21 before the time appointed for the taking of the poll;
- (b) if it to be taken within seven Clear Days after it was demanded, the form of appointment of a proxy and any accompanying authority (or an Electronic Record of the same) must be delivered in accordance with Article 12.21 before the time appointed for the taking of the poll.

12.23 If the form of appointment of proxy is not delivered on time, it is invalid.

12.24 When two or more valid but differing appointments of proxy are delivered or received in respect of the same Share for use at the same meeting and in respect of the same matter, the one which is last validly delivered or received (regardless of its date or of the date of its execution) shall be treated as replacing and revoking the other or others as regards that Share. If the Company is unable to determine which appointment was last validly delivered or received, none of them shall be treated as valid in respect of that Share.

12.25 The Board may at the expense of the Company send forms of appointment of proxy to the Members by post (that is to say, pre-paying and posting a letter), or by Electronic communication or otherwise (with or without provision for their return by pre-paid post) for use at any General Meeting or at any separate meeting of the holders of any class of Shares, either blank or nominating as proxy in the alternative any one or more of the Directors or any other person. If for the purpose of any meeting invitations to appoint as proxy a person or one of a number of persons specified in the invitations are issued at the Company's expense, they shall be issued to all (and not to some only) of the Members entitled to be sent notice of the meeting and to vote at it. The accidental omission to send such a form of appointment or to give such an invitation to, or the non-receipt of such form of appointment by, any Member entitled to attend and vote at a meeting shall not invalidate the proceedings at that meeting

**Voting by proxy**

12.26 A proxy shall have the same voting rights at a meeting or adjourned meeting as the Member would have had except to the extent that the instrument appointing such person limits those rights. Notwithstanding the appointment of a proxy, a Member may attend and vote at a meeting or adjourned meeting. If a Member votes on any resolution a vote by such Member's proxy on the same resolution, unless in respect of different Shares, shall be invalid.

**13 Number of Directors**

13.1 There shall be a Board consisting of not less than three persons provided however that the Company may by Ordinary Resolution increase or reduce the limits in the number of Directors. Unless fixed by Ordinary Resolution, the maximum number of Directors shall be unlimited.

**14 Appointment, disqualification and removal of Directors****First Directors**

14.1 The first Directors shall be appointed in writing by the subscriber or subscribers to the Memorandum, or a majority of them.

**No age limit**

14.2 There is no age limit for Directors save that they must be at least eighteen years of age.

**Corporate Directors**

14.3 Unless prohibited by law, a body corporate may be a Director. If a body corporate is a Director, the Articles about representation of corporate Members at General Meetings apply, mutatis mutandis, to the Articles about Directors' meetings.

**No shareholding qualification**

14.4 Unless a shareholding qualification for Directors is fixed by Ordinary Resolution, no Director shall be required to own Shares as a condition of his/her appointment.

**Appointment of Directors**

14.5 A Director may be appointed by Ordinary Resolution or by the Directors. Any appointment may be to fill a vacancy or as an additional Director.

14.6 A remaining Director may appoint a Director even though there is not a quorum of Directors.

14.7 No appointment can cause the number of Directors to exceed the maximum (if one is set); and any such appointment shall be invalid.

14.8 Subject to Article 17.14, for so long as Shares are listed on a Designated Stock Exchange, the Directors shall include at least such number of Independent Directors as applicable law, rules or regulations or the Designated Stock Exchange Rules require as determined by the Board.

#### **Board's power to appoint Directors**

14.9 Without prejudice to the Company's power to appoint a person to be a Director pursuant to these Articles, the Board shall have power at any time to appoint any person who is willing to act as a Director, either to fill a vacancy or as an addition to the existing Board, subject to the total number of Directors not exceeding any maximum number fixed by or in accordance with these Articles.

14.10 Any Director so appointed shall, if still a Director, retire at the next annual General Meeting after his/her appointment and be eligible to stand for election as a Director at such meeting.

#### **Eligibility**

14.11 No person (other than a Director retiring in accordance with these Articles) shall be appointed or re-appointed a Director at any General Meeting unless:

- (a) such person is recommended by the Board; or
- (b) not less than seven nor more than forty-two Clear Days before the date appointed for the meeting, a Member (other than the person to be proposed) entitled to vote at the meeting has given to the Company notice of such Member's intention to propose a resolution for the appointment of that person, stating the particulars which would, if that person were so appointed, be required to be included in the Company's register of Directors and a notice executed by that person of his/her willingness to be appointed.

#### **Appointment at annual General Meeting**

14.12 Unless re-appointed pursuant to the provisions of Article 14.5 or removed from office pursuant to the provisions of Article 14.13, each Director shall be appointed for a term expiring at the next-following annual General Meeting of the Company. At any such annual General Meeting, Directors will be elected by Ordinary Resolution. At each annual General Meeting of the Company, each Director elected at such meeting shall be elected to hold office for a one-year term and until the election of their respective successors in office or removal pursuant to Articles 14.5 and 14.13.

#### **Removal of Directors**

14.13 A Director may be removed by Ordinary Resolution.

### **Resignation of Directors**

- 14.14 A Director may at any time resign office by giving to the Company notice in writing or, if permitted pursuant to the notice provisions, in an Electronic Record delivered in either case in accordance with those provisions.
- 14.15 Unless the notice specifies a different date, the Director shall be deemed to have resigned on the date that the notice is delivered to the Company.

### **Termination of the office of Director**

- 14.16 A Director may retire from office as a Director by giving notice in writing to that effect to the Company at the registered office, which notice shall be effective upon such date as may be specified in the notice, failing which upon delivery to the registered office.
- 14.17 Without prejudice to the provisions in these Articles for retirement (by rotation or otherwise), a Director's office shall be terminated forthwith if:
- (a) he/she is prohibited by the law of the Cayman Islands from acting as a Director; or
  - (b) he/she is made bankrupt or makes an arrangement or composition with his/her creditors generally; or
  - (c) he/she resigns his/her office by notice to the Company; or
  - (d) he/she only held office as a Director for a fixed term and such term expires; or
  - (e) in the opinion of a registered medical practitioner by whom he/she is being treated he/she becomes physically or mentally incapable of acting as a Director; or
  - (f) the majority of the other Directors (being not less than two in number) determine that he/she should be removed as a Director, either by a resolution passed by the majority of the other Directors at a meeting of the Directors duly convened and held in accordance with these Articles or by a resolution in writing signed by the majority of the other Directors; or
  - (g) he/she is made subject to any law relating to mental health or incompetence, whether by court order or otherwise; or
  - (h) without the consent of the other Directors, he/she is absent from meetings of Directors for a continuous period of six months.

## 15 Alternate Directors

### Appointment and removal

- 15.1 Any Director may appoint any other person, including another Director, to act in his/her place as an alternate Director. No appointment shall take effect until the Director has given notice of the appointment to the Board.
- 15.2 Without limitation to the preceding Article, a Director may appoint an alternate for a particular meeting by sending an email to his/her fellow Directors informing them that they are to take such email as notice of such appointment for such meeting. Such appointment shall be effective without the need for a signed notice of appointment or the giving of notice to the Company in accordance with Article 15.4.
- 15.3 A Director may revoke his/her appointment of an alternate at any time. No revocation shall take effect until the Director has given notice of the revocation to the Board.
- 15.4 Subject to Article 15.2, a notice of appointment or removal of an alternate Director shall be effective only if given to the Company by one or more of the following methods:
- (a) by notice in writing in accordance with the notice provisions contained in these Articles;
  - (b) if the Company has a facsimile address for the time being, by sending by facsimile transmission to that facsimile address a facsimile copy or, otherwise, by sending by facsimile transmission to the facsimile address of the Company's registered office a facsimile copy (in either case, the facsimile copy being deemed to be the notice unless Article 29.7 applies), in which event notice shall be taken to be given on the date of an error-free transmission report from the sender's fax machine;
  - (c) if the Company has an email address for the time being, by emailing to that email address a scanned copy of the notice as a PDF attachment or, otherwise, by emailing to the email address provided by the Company's registered office a scanned copy of the notice as a PDF attachment (in either case, the PDF version being deemed to be the notice unless Article 29.7 applies), in which event notice shall be taken to be given on the date of receipt by the Company or the Company's registered office (as appropriate) in readable form; or
  - (d) if permitted pursuant to the notice provisions, in some other form of approved Electronic Record delivered in accordance with those provisions in writing.

### Notices

- 15.5 All notices of meetings of Directors shall continue to be given to the appointing Director and not to the alternate.

### **Rights of alternate Director**

15.6 An alternate Director shall be entitled to attend and vote at any Board meeting or meeting of a committee of the Directors at which the appointing Director is not personally present, and generally to perform all the functions of the appointing Director in his/her absence. An alternate Director, however, is not entitled to receive any remuneration from the Company for services rendered as an alternate Director.

### **Appointment ceases when the appointor ceases to be a Director**

15.7 An alternate Director shall cease to be an alternate Director if:

- (a) the Director who appointed him/her ceases to be a Director; or
- (b) the Director who appointed him/her revokes his/her appointment by notice delivered to the Board or to the registered office of the Company or in any other manner approved by the Board; or
- (c) in any event happens in relation to him/her which, if he/she were a Director of the Company, would cause his/her office as Director to be vacated.

### **Status of alternate Director**

15.8 An alternate Director shall carry out all functions of the Director who made the appointment.

15.9 Save where otherwise expressed, an alternate Director shall be treated as a Director under these Articles.

15.10 An alternate Director is not the agent of the Director appointing him/her.

15.11 An alternate Director is not entitled to any remuneration for acting as alternate Director.

### **Status of the Director making the appointment**

15.12 A Director who has appointed an alternate is not thereby relieved from the duties which he/she owes the Company.

## **16 Powers of Directors**

### **Powers of Directors**

16.1 Subject to the provisions of the Act, the Memorandum and these Articles the business of the Company shall be managed by the Directors who may for that purpose exercise all the powers of the Company.

16.2 No prior act of the Directors shall be invalidated by any subsequent alteration of the Memorandum or these Articles. However, to the extent allowed by the Act, Members may, by Special Resolution, validate any prior or future act of the Directors which would otherwise be in breach of their duties.

### **Directors below the minimum number**

16.3 If the number of Directors is less than the minimum prescribed in accordance with these Articles, the remaining Director or Directors shall act only for the purposes of appointing an additional Director or Directors to make up such minimum or of convening a General Meeting of the Company for the purpose of making such appointment. If there are no Director or Directors able or willing to act, any two Members may summon a General Meeting for the purpose of appointing Directors. Any additional Director so appointed shall hold office (subject to these Articles) only until the dissolution of the annual General Meeting next following such appointment unless he/she is re-elected during such meeting.

### **Appointments to office**

16.4 The Directors may appoint a Director:

- (a) as chairman of the Board;
- (b) as managing Director;
- (c) to any other executive office,

for such period, and on such terms, including as to remuneration as they think fit.

16.5 The appointee must consent in writing to holding that office.

16.6 Where a chairman is appointed he/she shall, unless unable to do so, preside at every meeting of Directors.

16.7 If there is no chairman, or if the chairman is unable to preside at a meeting, that meeting may select its own chairman; or the Directors may nominate one of their member to act in place of the chairman should he/she ever not be available.

16.8 Subject to the provisions of the Act, the Directors may also appoint and remove any person, who need not be a Director:

- (a) as Secretary; and
- (b) to any office that may be required

for such period and on such terms, including as to remuneration, as they think fit. In the case of an Officer, that Officer may be given any title the Directors decide.

16.9 The Secretary or Officer must consent in writing to holding that office.



16.10 A Director, Secretary or other Officer of the Company may not hold the office, or perform the services, of auditor.

#### **Provisions for employees**

16.11 The Board may make provision for the benefit of any persons employed or formerly employed by the Company or any of its subsidiary undertakings (or any member of his/her family or any person who is dependent on him/her) in connection with the cessation or the transfer to any person of the whole or part of the undertaking of the Company or any of its subsidiary undertakings.

#### **Exercise of voting rights**

16.12 The Board may exercise the voting power conferred by the Shares in any body corporate held or owned by the Company in such manner in all respects as it thinks fit (including, without limitation, the exercise of that power in favour of any resolution appointing any Director as a director of such body corporate, or voting or providing for the payment of remuneration to the directors of such body corporate).

#### **Remuneration**

16.13 Every Director may be remunerated by the Company for the services he/she provides for the benefit of the Company, whether as Director, employee or otherwise, and shall be entitled to be paid for the expenses incurred in the Company's business including attendance at Directors' meetings.

16.14 Until otherwise determined by the Company by Ordinary Resolution, the Directors (other than alternate Directors) shall be entitled to such remuneration by way of fees for their services in the office of Director as the Directors may determine.

16.15 Remuneration may take any form and may include arrangements to pay pensions, health insurance, death or sickness benefits, whether to the Director or to any other person connected to or related to him/her.

16.16 Unless his/her fellow Directors determine otherwise, a Director is not accountable to the Company for remuneration or other benefits received from any other company which is in the same group as the Company or which has common shareholdings.

## **Disclosure of information**

- 16.17 The Directors may release or disclose to a third party any information regarding the affairs of the Company, including any information contained in the register of Members relating to a Member, (and they may authorise any Director, Officer or other authorised agent of the Company to release or disclose to a third party any such information in such person's possession) if:
- (a) the Company or that person, as the case may be, is lawfully required to do so under the laws of any jurisdiction to which the Company is subject; or
  - (b) such disclosure is in compliance with the Designated Stock Exchange Rules; or
  - (c) such disclosure is in accordance with any contract entered into by the Company; or
  - (d) the Directors are of the opinion such disclosure would assist or facilitate the Company's operations.

## **17 Delegation of powers**

### **Power to delegate any of the Directors' powers to a committee**

- 17.1 The Directors may delegate any of their powers to any committee consisting of one or more persons who need not be Members. Persons on the committee may include non-Directors so long as the majority of those persons are Directors. Any such committee shall be made up of such number of Independent Directors as required from time to time by the Designated Stock Exchange Rules or otherwise required by applicable law.
- 17.2 The delegation may be collateral with, or to the exclusion of, the Directors' own powers.
- 17.3 The delegation may be on such terms as the Directors think fit, including provision for the committee itself to delegate to a sub-committee; save that any delegation must be capable of being revoked or altered by the Directors at will.
- 17.4 Unless otherwise permitted by the Directors, a committee must follow the procedures prescribed for the taking of decisions by Directors.
- 17.5 Subject to Article 17.14, the Board shall be entitled to establish, among others, an audit committee, a compensation committee and a nominating and corporate governance committee. Each of these committees shall be empowered to do all things necessary to exercise the rights of such committee set forth in these Articles. Each of the audit committee, compensation committee and nominating and corporate governance committee shall consist of at least three Directors (or such larger minimum number as may be required from time to time by the Designated Stock Exchange Rules). Subject to Article 17.14, the majority of the committee members on each of the compensation committee and nominating and corporate governance committee shall be Independent Directors. The audit committee shall be made up of such number of Independent Directors as required from time to time by the Designated Stock Exchange Rules or otherwise required by applicable law.

### **Local boards**

- 17.6 The Board may establish any local or divisional board or agency for managing any of the affairs of the Company whether in the Cayman Islands or elsewhere and may appoint any persons to be members of a local or divisional Board, or to be managers or agents, and may fix their remuneration.

17.7 The Board may delegate to any local or divisional board, manager or agent any of its powers and authorities (with power to sub-delegate) and may authorise the members of any local or divisional board or any of them to fill any vacancies and to act notwithstanding vacancies.

17.8 Any appointment or delegation under this Article 17.8 may be made on such terms and subject to such conditions as the Board thinks fit and the Board may remove any person so appointed, and may revoke or vary any delegation.

**Power to appoint an agent of the Company**

17.9 The Directors may appoint any person, either generally or in respect of any specific matter, to be the agent of the Company with or without authority for that person to delegate all or any of that person's powers. The Directors may make that appointment:

- (a) by causing the Company to enter into a power of attorney or agreement; or
- (b) in any other manner they determine.

**Power to appoint an attorney or authorised signatory of the Company**

17.10 The Directors may appoint any person, whether nominated directly or indirectly by the Directors, to be the attorney or the authorised signatory of the Company. The appointment may be:

- (a) for any purpose;
- (b) with the powers, authorities and discretions;
- (c) for the period; and
- (d) subject to such conditions

as they think fit. The powers, authorities and discretions, however, must not exceed those vested in, or exercisable, by the Directors under these Articles. The Directors may do so by power of attorney or any other manner they think fit.

17.11 Any power of attorney or other appointment may contain such provision for the protection and convenience for persons dealing with the attorney or authorised signatory as the Directors think fit. Any power of attorney or other appointment may also authorise the attorney or authorised signatory to delegate all or any of the powers, authorities and discretions vested in that person.

17.12 The Board may remove any person appointed under Article 17.10 and may revoke or vary the delegation.

### **Borrowing Powers**

- 17.13 The Directors may exercise all the powers of the Company to borrow money and to mortgage or charge its undertaking, property and assets both present and future and uncalled capital, or any part thereof, and to issue debentures and other securities, whether outright or as collateral security for any debt, liability or obligation of the Company or its parent undertaking (if any) or any subsidiary undertaking of the Company or of any third party.

### **Corporate Governance**

- 17.14 The Board may, from time to time, and except as required by applicable law or the Designated Stock Exchange Rules, adopt, institute, amend, modify or revoke the corporate governance policies or initiatives of the Company, which shall be intended to set forth the guiding principles and policies of the Company and the Board on various corporate governance related matters as the Board shall determine by resolution from time to time.

### **18 Meetings of Directors**

#### **Regulation of Directors' meetings**

- 18.1 Subject to the provisions of these Articles, the Directors may regulate their proceedings as they think fit.

#### **Calling meetings**

- 18.2 Any Director may call a meeting of Directors at any time. The Secretary must call a meeting of the Directors if requested to do so by a Director.

#### **Notice of meetings**

- 18.3 Notice of a Board meeting may be given to a Director personally or by word of mouth or given in writing or by Electronic communications at such address as he/she may from time to time specify for this purpose (or, if he/she does not specify an address, at his/her last known address). A Director may waive his/her right to receive notice of any meeting either prospectively or retrospectively.
- 18.4 Every Director shall be given notice of a meeting, although a Director may waive retrospectively the requirement to be given notice. Attendance at a meeting without written objection shall be deemed to be a waiver of such notice requirement.

#### **Use of technology**

- 18.5 A Director may participate in a meeting of Directors through the medium of conference telephone, video or any other form of communications equipment providing all persons participating in the meeting are able to hear and speak to each other throughout the meeting.
- 18.6 A Director participating in this way is deemed to be present in person at the meeting.

**Quorum**

18.7 The quorum for the transaction of business at a meeting of Directors shall be two unless the Directors fix some other number.

**Chairman or deputy to preside**

18.8 The Board may appoint a chairman and one or more deputy chairman or chairmen and may at any time revoke any such appointment.

18.9 The chairman, or failing him/her any deputy chairman (the longest in office taking precedence if more than one is present), shall preside at all Board meetings. If no chairman or deputy chairman has been appointed, or if he/she is not present within five minutes after the time fixed for holding the meeting, or is unwilling to act as chairman of the meeting, the Directors present shall choose one of their member to act as chairman of the meeting.

**Voting**

18.10 A question which arises at a Board meeting shall be decided by a majority of votes. If votes are equal the chairman may, if he/she wishes, exercise a casting vote.

**Recording of dissent**

18.11 A Director present at a meeting of Directors shall be presumed to have assented to any action taken at that meeting unless:

- (a) his/her dissent is entered in the minutes of the meeting; or
- (b) he has filed with the meeting before it is concluded signed dissent from that action; or
- (c) he has forwarded to the Company as soon as practical following the conclusion of that meeting signed dissent.

A Director who votes in favour of an action is not entitled to record his/her dissent to it.

**Written resolutions**

18.12 The Directors may pass a resolution in writing without holding a meeting if all Directors sign a document or sign several documents in the like form each signed by one or more of those Directors.

18.13 A written resolution signed by a validly appointed alternate Director need not also be signed by the appointing Director.

18.14 A written resolution signed personally by the appointing Director need not also be signed by his/her alternate.

- 18.15 A resolution in writing passed pursuant to Article 18.12, Article 18.13 and/or Article 18.14 shall be as effective as if it had been passed at a meeting of the Directors duly convened and held; and it shall be treated as having been passed on the day and at the time that the last Director signs (and for the avoidance of doubt, such day may or may not be a Business Day).

**Validity of acts of Directors in spite of formal defect**

- 18.16 All acts done by a meeting of the Board, or of a committee of the Board, or by any person acting as a Director or an alternate Director, shall, notwithstanding that it is afterwards discovered that there was some defect in the appointment of any Director or alternate Director or member of the committee, or that any of them were disqualified or had vacated office or were not entitled to vote, be as valid as if every such person had been duly appointed and qualified and had continued to be a Director or alternate Director and had been entitled to vote.

**19 Permissible Directors' interests and disclosure**

**Permissible interests subject to disclosure**

- 19.1 Save as expressly permitted by these Articles or as set out below, a Director may not have a direct or indirect interest or duty which conflicts or may possibly conflict with the interests of the Company.
- 19.2 If, notwithstanding the prohibition in the preceding Article, a Director discloses to his/her fellow Directors the nature and extent of any material interest or duty in accordance with the next Article, he/she may:
- (a) be a party to, or otherwise interested in, any transaction or arrangement with the Company or in which the Company is or may otherwise be interested; or
  - (b) be interested in another body corporate promoted by the Company or in which the Company is otherwise interested. In particular, the Director may be a director, secretary or officer of, or employed by, or be a party to any transaction or arrangement with, or otherwise interested in, that other body corporate.
- 19.3 Such disclosure may be made at a meeting of the board or otherwise (and, if otherwise, it must be made in writing). The Director must disclose the nature and extent of his/her direct or indirect interest in or duty in relation to a transaction or arrangement or series of transactions or arrangements with the Company or in which the Company has any material interest.
- 19.4 If a Director has made disclosure in accordance with the preceding Article, then he/she shall not, by reason only of his/her office, be accountable to the Company for any benefit that he/she derives from any such transaction or arrangement or from any such office or employment or from any interest in any such body corporate, and no such transaction or arrangement shall be liable to be avoided on the ground of any such interest or benefit.

## **Notification of interests**

19.5 For the purposes of the preceding Articles:

- (a) a general notice that a Director gives to the other Directors that he/she is to be regarded as having an interest of the nature and extent specified in the notice in any transaction or arrangement in which a specified person or class of persons is interested shall be deemed to be a disclosure that he/she has an interest in or duty in relation to any such transaction of the nature and extent so specified; and
- (b) an interest of which a Director has no knowledge and of which it is unreasonable to expect such Director to have knowledge shall not be treated as an interest of his/her.

## **Voting where a Director is interested in a matter**

19.6 A Director may vote at a meeting of Directors on any resolution concerning a matter in which that Director has an interest or duty, whether directly or indirectly, so long as that Director discloses any material interest pursuant to these Articles. The Director shall be counted towards a quorum of those present at the meeting. If the Director votes on the resolution, his/her vote shall be counted.

19.7 Where proposals are under consideration concerning the appointment of two or more Directors to offices or employment with the Company or any body corporate in which the Company is interested, the proposals may be divided and considered in relation to each Director separately and each of the Directors concerned shall be entitled to vote and be counted in the quorum in respect of each resolution except that concerning his or her own appointment.

## **20 Minutes**

20.1 The Company shall cause minutes to be made in books of:

- (a) all appointments of Officers and committees made by the Board and of any such Officer's remuneration; and
- (b) the names of Directors present at every meeting of the Directors, a committee of the Board, the Company or the holders of any class of shares or debentures, and all orders, resolutions and proceedings of such meetings.

20.2 Any such minutes, if purporting to be signed by the chairman of the meeting at which the proceedings were held or by the chairman of the next succeeding meeting or the Secretary, shall be prima facie evidence of the matters stated in them.

## **21 Accounts and audit; Financial year**

- 21.1 The Directors must ensure that proper accounting and other records are kept, and that accounts and associated reports are distributed in accordance with the requirements of the Act.
- 21.2 Unless the Directors otherwise prescribe, the financial year of the Company shall end on 30 June in each year and begin on 1 July in each year.

### **Auditors**

- 21.3 The Directors may appoint an Auditor of the Company who shall hold office on such terms as the Directors determine.
- 21.4 At any General Meeting convened and held at any time in accordance with these Articles, the Members may, by Ordinary Resolution, remove the Auditor before the expiration of its term of office. If they do so, the Members shall, by Ordinary Resolution, at that meeting appoint another Auditor in its stead for the remainder of its term.
- 21.5 The Auditors shall examine such books, accounts and vouchers; as may be necessary for the performance of their duties.
- 21.6 The Auditors shall, if so requested by the Directors, make a report on the accounts of the Company during their tenure of office at the next annual General Meeting following their appointment, and at any time during their term of office, upon request of the Directors or any General Meeting of the Company.

## **22 Record dates**

- 22.1 Except to the extent of any conflicting rights attached to Shares, the resolution declaring a dividend on Shares of any class, whether it be an Ordinary Resolution of the Members or a Director's resolution, may specify that the dividend is payable or distributable to the persons registered as the holders of those Shares at the close of business on a particular date, notwithstanding that the date may be a date prior to that on which the resolution is passed.
- 22.2 If the resolution does so specify, the dividend shall be payable or distributable to the persons registered as the holders of those Shares at the close of business on the specified date in accordance with their respective holdings so registered, but without prejudice to the rights *inter se* in respect of the dividend of transferors and transferees of any of those Shares.
- 22.3 The provisions of this Article apply, *mutatis mutandis*, to bonuses, capitalisation issues, distributions of realised capital profits or offers or grants made by the Company to the Members.



## **23 Dividends**

### **Source of dividends**

- 23.1 Dividends may be declared and paid out of any funds of the Company lawfully available for distribution.
- 23.2 Subject to the requirements of the Act regarding the application of a company's Share premium account and with the sanction of an Ordinary Resolution, dividends may also be declared and paid out of any share premium account.

### **Declaration of dividends by Members**

- 23.3 Subject to the provisions of the Act, the Company may by Ordinary Resolution declare dividends in accordance with the respective rights of the Members but no dividend shall exceed the amount recommended by the Directors.

### **Payment of interim dividends and declaration of final dividends by Directors**

- 23.4 The Directors may declare and pay interim dividends or recommend final dividends in accordance with the respective rights of the Members if it appears to them that they are justified by the financial position of the Company and that such dividends may lawfully be paid.
- 23.5 Subject to the provisions of the Act, in relation to the distinction between interim dividends and final dividends, the following applies:
- (a) Upon determination to pay a dividend or dividends described as interim by the Directors in the dividend resolution, no debt shall be created by the declaration until such time as payment is made.
  - (b) Upon declaration of a dividend or dividends described as final by the Directors in the dividend resolution, a debt shall be created immediately following the declaration, the due date to be the date the dividend is stated to be payable in the resolution.

If the resolution fails to specify whether a dividend is final or interim, it shall be assumed to be interim.

- 23.6 In relation to Shares carrying differing rights to dividends or rights to dividends at a fixed rate, the following applies:
- (a) If the share capital is divided into different classes, the Directors may pay dividends on Shares which confer deferred or non-preferred rights with regard to dividends as well as on Shares which confer preferential rights with regard to dividends but no dividend shall be paid on Shares carrying deferred or non-preferred rights if, at the time of payment, any preferential dividend is in arrears.

- (b) The Directors may also pay, at intervals settled by them, any dividend payable at a fixed rate if it appears to them that there are sufficient funds of the Company lawfully available for distribution to justify the payment.
- (c) If the Directors act in good faith, they shall not incur any liability to the Members holding Shares conferring preferred rights for any loss those Members may suffer by the lawful payment of the dividend on any Shares having deferred or non-preferred rights.

#### **Apportionment of dividends**

- 23.7 Except as otherwise provided by the rights attached to Shares all dividends shall be declared and paid according to the amounts Paid Up on the Shares on which the dividend is paid. All dividends shall be apportioned and paid proportionately to the amount Paid Up on the Shares during the time or part of the time in respect of which the dividend is paid. But if a Share is issued on terms providing that it shall rank for dividend as from a particular date, that Share shall rank for dividend accordingly.

#### **Right of set off**

- 23.8 The Directors may deduct from a dividend or any other amount payable to a person in respect of a Share any amount due by that person to the Company on a call or otherwise in relation to a Share.

#### **Power to pay other than in cash**

- 23.9 If the Directors so determine, any resolution declaring a dividend may direct that it shall be satisfied wholly or partly by the distribution of assets. If a difficulty arises in relation to the distribution, the Directors may settle that difficulty in any way they consider appropriate. For example, they may do any one or more of the following:
- (a) issue fractional Shares;
  - (b) fix the value of assets for distribution and make cash payments to some Members on the footing of the value so fixed in order to adjust the rights of Members; and
  - (c) vest some assets in trustees.

#### **How payments may be made**

- 23.10 A dividend or other monies payable on or in respect of a Share may be paid in any of the following ways:
- (a) if the Member holding that Share or other person entitled to that Share nominates a bank account for that purpose - by wire transfer to that bank account;  
or

(b) by cheque or warrant sent by post to the registered address of the Member holding that Share or other person entitled to that Share.

23.11 For the purposes of Article 23.10(a), the nomination may be in writing or in an Electronic Record and the bank account nominated may be the bank account of another person. For the purposes of Article 23.10(b), subject to any applicable law or regulation, the cheque or warrant shall be made to the order of the Member holding that Share or other person entitled to the Share or to his nominee, whether nominated in writing or in an Electronic Record, and payment of the cheque or warrant shall be a good discharge to the Company.

23.12 If two or more persons are registered as the holders of the Share or are jointly entitled to it by reason of the death or bankruptcy of the registered holder (**Joint Holders**), a dividend (or other amount) payable on or in respect of that Share may be paid as follows:

(a) to the registered address of the Joint Holder of the Share who is named first on the register of Members or to the registered address of the deceased or bankrupt holder, as the case may be; or

(b) to the address or bank account of another person nominated by the Joint Holders, whether that nomination is in writing or in an Electronic Record.

23.13 Any Joint Holder of a Share may give a valid receipt for a dividend (or other amount) payable in respect of that Share.

#### **Dividends or other monies not to bear interest in absence of special rights**

23.14 Unless provided for by the rights attached to a Share, no dividend or other monies payable by the Company in respect of a Share shall bear interest.

#### **Dividends unable to be paid or unclaimed**

23.15 If a dividend cannot be paid to a Member or remains unclaimed within six weeks after it was declared or both, the Directors may pay it into a separate account in the Company's name. If a dividend is paid into a separate account, the Company shall not be constituted trustee in respect of that account and the dividend shall remain a debt due to the Member.

23.16 A dividend that remains unclaimed for a period of six years after it became due for payment shall be forfeited to, and shall cease to remain owing by, the Company.

### **24 Capitalisation of profits**

#### **Capitalisation of profits or of any share premium account or capital redemption reserve;**

24.1 The Directors may resolve to capitalise:

(a) any part of the Company's profits not required for paying any preferential dividend (whether or not those profits are available for distribution); or

(b) any sum standing to the credit of the Company's share premium account or capital redemption reserve, if any.

24.2 The amount resolved to be capitalised must be appropriated to the Members who would have been entitled to it had it been distributed by way of dividend and in the same proportions. The benefit to each Member so entitled must be given in either or both of the following ways::

(a) by paying up the amounts unpaid on that Member's Shares;

(b) by issuing Fully Paid Up Shares, debentures or other securities of the Company to that Member or as that Member directs. The Directors may resolve that any Shares issued to the Member in respect of Partly Paid Up Shares (**Original Shares**) rank for dividend only to the extent that the Original Shares rank for dividend while those Original Shares remain Partly Paid Up.

#### **Applying an amount for the benefit of Members**

24.3 The amount capitalised must be applied to the benefit of Members in the proportions to which the Members would have been entitled to dividends if the amount capitalised had been distributed as a dividend.

24.4 Subject to the Act, if a fraction of a Share, a debenture or other security is allocated to a Member, the Directors may issue a fractional certificate to that Member or pay such person the cash equivalent of the fraction.

#### **25 Share Premium Account**

##### **Directors to maintain share premium account**

25.1 The Directors shall establish a share premium account in accordance with the Act. They shall carry to the credit of that account from time to time an amount equal to the amount or value of the premium paid on the issue of any Share or capital contributed or such other amounts required by the Act.

##### **Debits to share premium account**

25.2 The following amounts shall be debited to any share premium account:

(a) on the redemption or purchase of a Share, the difference between the nominal value of that Share and the redemption or purchase price; and

(b) any other amount paid out of a share premium account as permitted by the Act.

25.3 Notwithstanding the preceding Article, on the redemption or purchase of a Share, the Directors may pay the difference between the nominal value of that Share and the redemption purchase price out of the profits of the Company or, as permitted by the Act, out of capital.

## 26 Seal

### Company seal

26.1 The Company may have a seal if the Directors so determine.

### Duplicate seal

26.2 Subject to the provisions of the Act, the Company may also have a duplicate seal or seals for use in any place or places outside the Cayman Islands. Each duplicate seal shall be a facsimile of the original seal of the Company. However, if the Directors so determine, a duplicate seal shall have added on its face the name of the place where it is to be used.

### When and how seal is to be used

26.3 A seal may only be used by the authority of the Directors. Unless the Directors otherwise determine, a document to which a seal is affixed must be signed in one of the following ways:

- (a) by a Director (or his/her alternate) and the Secretary; or
- (b) by a single Director (or his/her alternate).

### If no seal is adopted or used

26.4 If the Directors do not adopt a seal, or a seal is not used, a document may be executed in the following manner:

- (a) by a Director (or his/her alternate) or any Officer to which authority has been delegated by resolution duly adopted by the Directors; or
- (b) by a single Director (or his/her alternate); or
- (c) in any other manner permitted by the Act.

### Power to allow non-manual signatures and facsimile printing of seal

26.5 The Directors may determine that either or both of the following applies:

- (a) that the seal or a duplicate seal need not be affixed manually but may be affixed by some other method or system of reproduction;
- (b) that a signature required by these Articles need not be manual but may be a mechanical or Electronic Signature.

### Validity of execution

26.6 If a document is duly executed and delivered by or on behalf of the Company, it shall not be regarded as invalid merely because, at the date of the delivery, the Secretary, or the Director, or other Officer or person who signed the document or affixed the seal for and on behalf of the Company ceased to be the Secretary or hold that office and authority on behalf of the Company.

**27 Indemnity**

- 27.1 To the extent permitted by law, the Company shall indemnify each existing or former Director (including alternate Director), Secretary and other Officer of the Company (including an investment adviser or an administrator or liquidator) and their personal representatives against:
- (a) all actions, proceedings, costs, charges, expenses, losses, damages or liabilities incurred or sustained by the existing or former Director (including alternate Director), Secretary or Officer in or about the conduct of the Company's business or affairs or in the execution or discharge of the existing or former Director's (including alternate Director's), Secretary's or Officer's duties, powers, authorities or discretions; and
  - (b) without limitation to paragraph (a), all costs, expenses, losses or liabilities incurred by the existing or former Director (including alternate Director), Secretary or Officer in defending (whether successfully or otherwise) any civil, criminal, administrative or investigative proceedings (whether threatened, pending or completed) concerning the Company or its affairs in any court or tribunal, whether in the Cayman Islands or elsewhere.

Such indemnity only applies if the Directors are of the view that, in the absence of fraud, wilful default or wilful neglect, an existing or former Director (including alternate Director), Secretary or Officer acted honestly and in good faith with a view to what the person believes is in the best interests of the Company and, in the case of criminal proceedings, such person had no reasonable cause to believe that their conduct was unlawful. No such existing or former Director (including alternate Director), Secretary or Officer, however, shall be indemnified in respect of any matter arising out of his/her own actual fraud, wilful default or wilful neglect.

- 27.2 To the extent permitted by Act, the Company may make a payment, or agree to make a payment, whether by way of advance, loan or otherwise, for any legal costs incurred by an existing or former Director (including alternate Director), Secretary or Officer of the Company in respect of any matter identified in Article 27.1 on condition that the Director (including alternate Director), Secretary or Officer must repay the amount paid by the Company to the extent that it is ultimately found not liable to indemnify the Director (including alternate Director), Secretary or that Officer for those legal costs.

**Release**

- 27.3 To the extent permitted by Act, the Company may by Special Resolution release any existing or former Director (including alternate Director), Secretary or other Officer of the Company from liability for any loss or damage or right to compensation which may arise out of or in connection with the execution or discharge of the duties, powers, authorities or discretions of his/her office; but there may be no release from liability arising out of or in connection with that person's own actual fraud, wilful default or wilful neglect.

## **Insurance**

27.4 To the extent permitted by Act, the Company may pay, or agree to pay, a premium in respect of a contract insuring each of the following persons against risks determined by the Directors, other than liability arising out of that person's own dishonesty:

- (a) an existing or former Director (including alternate Director), Secretary or Officer of:
  - (i) the Company;
  - (ii) a company which is or was a subsidiary of the Company;
  - (iii) a company in which the Company has or had an interest (whether direct or indirect); and
- (b) a trustee of an employee or retirement benefits scheme or other trust in which any of the persons referred to in paragraph (a) is or was interested.

## **28 Notices**

### **Form of notices**

28.1 Save where these Articles provide otherwise, and subject to the Designated Stock Exchange Rules, any notice to be given to or by any person pursuant to these Articles shall be:

- (a) in writing signed by or on behalf of the giver in the manner set out below for written notices; or
- (b) subject to the next Article, in an Electronic Record signed by or on behalf of the giver by Electronic Signature and authenticated in accordance with Articles about authentication of Electronic Records; or
- (c) where these Articles expressly permit, by the Company by means of a website.

### **Electronic communications**

28.2 A notice may only be given to the Company in an Electronic Record if:

- (a) the Directors so resolve;
- (b) the resolution states how an Electronic Record may be given and, if applicable, specifies an email address for the Company; and

- (c) the terms of that resolution are notified to the Members for the time being and, if applicable, to those Directors who were absent from the meeting at which the resolution was passed.

If the resolution is revoked or varied, the revocation or variation shall only become effective when its terms have been similarly notified.

28.3 A notice may not be given by Electronic Record to a person other than the Company unless the recipient has notified the giver of an Electronic address to which notice may be sent.

28.4 Subject to the Act, the Designated Stock Exchange Rules and to any other rules which the Company is bound to follow, the Company may also send any notice or other document pursuant to these Articles to a Member by publishing that notice or other document on a website where:

- (a) the Company and the Member have agreed to his/her/its having access to the notice or document on a website (instead of it being sent to such person);
- (b) the notice or document is one to which that agreement applies;
- (c) the Member is notified (in accordance with any requirements laid down by the Act and, in a manner for the time being agreed between such person and the Company for the purpose) of:
  - (i) the publication of the notice or document on a website;
  - (ii) the address of that website; and
  - (iii) the place on that website where the notice or document may be accessed, and how it may be accessed; and
- (d) the notice or document is published on that website throughout the publication period, provided that, if the notice or document is published on that website for a part, but not all of, the publication period, the notice or document shall be treated as being published throughout that period if the failure to publish that notice or document throughout that period is wholly attributable to circumstances which it would not be reasonable to have expected the Company to prevent or avoid. For the purposes of this Article 28.4 "publication period" means a period of not less than twenty-one days, beginning on the day on which the notification referred to in Article 28.4(c) is deemed sent.

**Validity despite accidental error in publication on website**

28.5 If, for the purpose of a meeting, documents are sent by being published on a website in accordance with the preceding Articles, the proceedings at that meeting are not invalidated merely because:

- (a) those documents are, by accident, published in a different place on the website to the place notified; or
- (b) they are published for part only of the period from the date of notification until the conclusion of that meeting.



**Persons entitled to notices**

28.6 Any notice or other document to be given to a Member may be given by reference to the register of Members as it stands at any time within the period of twenty-one days before the day that the notice is given or (where and as applicable) within any other period permitted by, or in accordance with the requirements of, (to the extent applicable) the Designated Stock Exchange Rules and/or the Designated Stock Exchanges. No change in the register of Members after that time shall invalidate the giving of such notice or document or require the Company to give such item to any other person.

**Persons authorised to give notices**

28.7 A notice by either the Company or a Member pursuant to these Articles may be given on behalf of the Company or a Member by a Director or company secretary of the Company or a Member.

**Delivery of written notices**

28.8 Save where these Articles provide otherwise, a notice in writing may be given personally to the recipient, or left at (as appropriate) the Member's or Director's registered address or the Company's registered office, or posted to that registered address or registered office.

**Joint holders**

28.9 Where Members are joint holders of a Share, all notices shall be given to the Member whose name first appears in the register of Members.

**Signatures**

28.10 A written notice shall be signed when it is autographed by or on behalf of the giver, or is marked in such a way as to indicate its execution or adoption by the giver.

28.11 An Electronic Record may be signed by an Electronic Signature.

**Evidence of transmission**

28.12 A notice given by Electronic Record shall be deemed sent if an Electronic Record is kept demonstrating the time, date and content of the transmission, and if no notification of failure to transmit is received by the giver.

28.13 A notice given in writing shall be deemed sent if the giver can provide proof that the envelope containing the notice was properly addressed, pre-paid and posted, or that the written notice was otherwise properly transmitted to the recipient.

28.14 A Member present, either in person or by proxy, at any meeting of the Company or of the holders of any class of Shares shall be deemed to have received due notice of the meeting and, where requisite, of the purposes for which it was called.

**Giving notice to a deceased or bankrupt Member**

28.15 A notice may be given by the Company to the persons entitled to a Share in consequence of the death or bankruptcy of a Member by sending or delivering it, in any manner authorised by these Articles for the giving of notice to a Member, addressed to them by name, or by the title of representatives of the deceased, or trustee of the bankrupt or by any like description, at the address, if any, supplied for that purpose by the persons claiming to be so entitled.

28.16 Until such an address has been supplied, a notice may be given in any manner in which it might have been given if the death or bankruptcy had not occurred.

**Date of giving notices**

28.17 A notice is given on the date identified in the following table

<b>Method for giving notices</b>	<b>When taken to be given</b>
(A) Personally	At the time and date of delivery
(B) By leaving it at the Member's registered address	At the time and date it was left
(C) By posting it by prepaid post to the street or postal address of that recipient	48 hours after the date it was posted
(D) By Electronic Record (other than publication on a website), to recipient's Electronic address	48 hours after the date it was sent
(E) By publication on a website	24 hours after the date on which the Member is deemed to have been notified of the publication of the notice or document on the website

**Saving provision**

28.18 None of the preceding notice provisions shall derogate from the Articles about the delivery of written resolutions of Directors and written resolutions of Members.

## 29 Authentication of Electronic Records

### Application of Articles

29.1 Without limitation to any other provision of these Articles, any notice, written resolution or other document under these Articles that is sent by Electronic means by a Member, or by the Secretary, or by a Director or other Officer of the Company, shall be deemed to be authentic if either Article 29.2 or Article 29.4 applies.

### Authentication of documents sent by Members by Electronic means

29.2 An Electronic Record of a notice, written resolution or other document sent by Electronic means by or on behalf of one or more Members shall be deemed to be authentic if the following conditions are satisfied:

- (a) the Member or each Member, as the case may be, signed the original document, and for this purpose **Original Document** includes several documents in like form signed by one or more of those Members; and
- (b) the Electronic Record of the Original Document was sent by Electronic means by, or at the direction of, that Member to an address specified in accordance with these Articles for the purpose for which it was sent; and
- (c) Article 29.7 does not apply.

29.3 For example, where a sole Member signs a resolution and sends the Electronic Record of the original resolution, or causes it to be sent, by facsimile transmission to the address in these Articles specified for that purpose, the facsimile copy shall be deemed to be the written resolution of that Member unless Article 29.7 applies.

### Authentication of document sent by the Secretary or Officers of the Company by Electronic means

29.4 An Electronic Record of a notice, written resolution or other document sent by or on behalf of the Secretary or an Officer or Officers of the Company shall be deemed to be authentic if the following conditions are satisfied:

- (a) the Secretary or the Officer or each Officer, as the case may be, signed the original document, and for this purpose **Original Document** includes several documents in like form signed by the Secretary or one or more of those Officers; and
- (b) the Electronic Record of the Original Document was sent by Electronic means by, or at the direction of, the Secretary or that Officer to an address specified in accordance with these Articles for the purpose for which it was sent; and
- (c) Article 29.7 does not apply.

This Article 29.4 applies whether the document is sent by or on behalf of the Secretary or Officer in his/her own right or as a representative of the Company.

- 29.5 For example, where a sole Director signs a resolution and scans the resolution, or causes it to be scanned, as a PDF version which is attached to an email sent to the address in these Articles specified for that purpose, the PDF version shall be deemed to be the written resolution of that Director unless Article 29.7 applies.

**Manner of signing**

- 29.6 For the purposes of these Articles about the authentication of Electronic Records, a document will be taken to be signed if it is signed manually or in any other manner permitted by these Articles.

**Saving provision**

- 29.7 A notice, written resolution or other document under these Articles will not be deemed to be authentic if the recipient, acting reasonably:

- (a) believes that the signature of the signatory has been altered after the signatory had signed the original document; or
- (b) believes that the original document, or the Electronic Record of it, was altered, without the approval of the signatory, after the signatory signed the original document; or
- (c) otherwise doubts the authenticity of the Electronic Record of the document

and the recipient promptly gives notice to the sender setting the grounds of its objection. If the recipient invokes this Article, the sender may seek to establish the authenticity of the Electronic Record in any way the sender thinks fit.

**30 Transfer by way of continuation**

- 30.1 The Company may, by Special Resolution, resolve to be registered by way of continuation in a jurisdiction outside:

- (a) the Cayman Islands; or
- (b) such other jurisdiction in which it is, for the time being, incorporated, registered or existing.

- 30.2 To give effect to any resolution made pursuant to the preceding Article, the Directors may cause the following:

- (a) an application be made to the Registrar of Companies of the Cayman Islands to deregister the Company in the Cayman Islands or in the other jurisdiction in which it is for the time being incorporated, registered or existing; and

(b) all such further steps as they consider appropriate to be taken to effect the transfer by way of continuation of the Company.

### **31 Winding up**

#### **Distribution of assets in specie**

31.1 If the Company is wound up the Members may, subject to these Articles and any other sanction required by the Act, pass a Special Resolution allowing the liquidator to do either or both of the following:

- (a) to divide in specie among the Members the whole or any part of the assets of the Company and, for that purpose, to value any assets and to determine how the division shall be carried out as between the Members or different classes of Members; and/or
- (b) to vest the whole or any part of the assets in trustees for the benefit of Members and those liable to contribute to the winding up.

#### **No obligation to accept liability**

31.2 No Member shall be compelled to accept any assets if an obligation attaches to them.

31.3 The Directors are authorised to present a winding up petition

31.4 The Directors have the authority to present a petition for the winding up of the Company to the Grand Court of the Cayman Islands on behalf of the Company without the sanction of a resolution passed at a General Meeting.

### **32 Amendment of Memorandum and Articles**

#### **Power to change name or amend Memorandum**

32.1 Subject to the Act, the Company may, by Special Resolution:

- (a) change its name; or
- (b) change the provisions of its Memorandum with respect to its objects, powers or any other matter specified in the Memorandum.

#### **Power to amend these Articles**

32.2 Subject to the Act and as provided in these Articles, the Company may, by Special Resolution, amend these Articles in whole or in part.

**33 Mergers and Consolidations**

33.1 The Company shall have the power to merge or consolidate with one or more constituent companies (as defined in the Act) upon such terms as the Directors may determine and (to the extent required by the Act) with the approval of a Special Resolution.

**34 Certain Tax Filings**

34.1 Each Tax Filing Authorised Person and any such other person, acting alone, as any Director shall designate from time to time, are authorised to file tax forms SS-4, W-8 BEN, W-8 IMY, W-9, 8832 and 2553 and such other tax forms as are customary to file with any US state or federal governmental authorities or foreign governmental authorities in connection with the formation, activities and/or elections of the Company and such other tax forms as may be approved from time to time by any Director of the Company or an Officer. The Company further ratifies and approves any such filing made by any Tax Filing Authorised Person or such other person prior to the date of these Articles.

## WARRANT ASSUMPTION AGREEMENT

THIS WARRANT ASSUMPTION AGREEMENT (this “**Agreement**”) is entered into as of [\_\_], 2023, by among Prime Number Acquisition I Corp., a Delaware corporation (“**Company**”), Prime Number Holding Limited, a Cayman Islands exempted PubCo limited by shares (“**PubCo**”), and VStock Transfer, LLC, a California limited liability company (the “**Warrant Agent**”). Capitalized terms used and not otherwise defined herein shall have the meanings given such terms in the Warrant Agreement (as defined below).

## WITNESSETH:

WHEREAS, the Company and the Warrant Agent are parties to a certain Warrant Agreement, dated as of May 12, 2022 (the “**Warrant Agreement**”), pursuant to which Company issued warrants to purchase its shares of Class A common stock, par value \$0.0001 per share (the “**Warrants**”);

WHEREAS, the Company entered into a Business Combination Agreement, dated as of December [\_\_], 2022 (the “**Business Combination Agreement**”) with PubCo, Prime Number Acquisition Merger Sub Inc., a Delaware corporation and a wholly-owned subsidiary of PubCo, the (“**Merger Sub**”), and certain other parties;

WHEREAS, pursuant to the Business Combination Agreement and subject to the terms and conditions therein, Merger Sub will merge with and into the Company (the “**Merger**”), with the Company surviving the Merger as a wholly owned subsidiary of PubCo;

WHEREAS, pursuant to the Business Combination Agreement, at the effective time of the Merger, each Warrant outstanding immediately prior to the effective time of the Merger shall be automatically converted into one warrant issued by PubCo (“**PubCo Warrants**”), and all such converted Warrants shall thereupon cease to be outstanding and shall automatically be canceled and retired and shall cease to exist. Each of the PubCo Warrants shall have, and be subject to, substantially the same terms and conditions set forth in the Warrant Agreement, except that they shall represent the right to acquire ordinary shares of PubCo, par value \$0.0001 per share in lieu of shares of Class A common stock of the Company.

WHEREAS, Section 4.5 of the Warrant Agreement provides that, in the case of any merger or consolidation of the Company with or into another corporation (other than a consolidation or merger in which the Company is the continuing corporation and that does not result in any reclassification or reorganization of the issued and outstanding shares of Class A Common Stock) (a “**Merger Event**”), the Registered Holder of the Warrants shall thereafter have the right to purchase and receive, upon the basis and upon the terms and conditions specified in the Warrants and in lieu of the shares of Class A common stock of the Company immediately theretofore purchasable and receivable upon the exercise of the rights represented thereby, the kind and amount of shares of stock or other securities or property (including cash) receivable upon such reclassification, reorganization, merger or consolidation, that the holder of the Warrants would have received if such holder had exercised his, her or its Warrant(s) immediately prior to such event;

WHEREAS, pursuant to the Business Combination Agreement and the Warrant Agreement, PubCo desires to assume the obligations of the Company under the Warrant Agreement and the Warrants;

NOW, THEREFORE, in consideration of the foregoing and for other good and valuable consideration, the receipt of which is hereby acknowledged, the Company, PubCo, and the Warrant Agent covenant and agree for the benefit of the holders of Warrants as follows:

ARTICLE 1  
EFFECT OF MERGER EVENT ON WARRANT TERMS

Section 1.01. Warrant Terms. In accordance with Section 4.5 of the Warrant Agreement, at the effective time of the Merger, each Warrant that is outstanding as of the effective time of the Merger shall be exercisable, subject and pursuant to the terms of the Warrant Agreement, for one share of ordinary shares of PubCo for \$11.50 per share.

ARTICLE 2  
PUBCO ASSUMPTION

Section 2.01. Assumption. PubCo hereby assumes the obligations of the Company under the Warrant Agreement and the Warrants.

ARTICLE 3  
MISCELLANEOUS

Section 3.01. Governing Law. The validity, interpretation, and performance of this Agreement shall be governed in all respects by the laws of the State of New York, without giving effect to conflicts of law principles that would result in the application of the substantive laws of another jurisdiction.

Section 3.02. Counterparts. This Agreement may be executed in any number of counterparts, each of which shall be an original, but such counterparts shall together constitute but one and the same instrument. The exchange of copies of this Agreement and of signature pages by facsimile or PDF transmission shall constitute effective execution and delivery of this Agreement as to the parties hereto and signatures of the parties hereto transmitted by facsimile or PDF shall be deemed to be their original signatures for all purposes.

*[Signature Pages Follow]*



IN WITNESS WHEREOF, the parties have caused this Warrant Assumption Agreement to be duly executed as of the date first written above.

**Prime Number Acquisition I Corp.**  
as **Company**

By: \_\_\_\_\_  
Name: Dongfeng Wang  
Title: Director

**Prime Number Holding Limited**  
as **PubCo**

By: \_\_\_\_\_  
Name: Dongfeng Wang  
Title: Director

**VStock Transfer, LLC**  
as **Warrant Agent**

By: \_\_\_\_\_  
Name:  
Title:

[Signature Page to Warrant Assumption Agreement]

---

Agreed Form

Prime Number Acquisition I Corp. (the "Company")  
1129 Northern Blvd., Suite 404  
Manhasset, NY 11030

Prime Number Holding Limited (the "PubCo")  
1129 Northern Blvd., Suite 404  
Manhasset, NY 11030

**BY MAIL**

VStock Transfer, LLC  
18 Lafayette Place,  
Woodmere, NY 11598  
Attn: Chief Executive Officer

[\*], 2023

**RE: WARRANT AGREEMENT ENTERED INTO BETWEEN THE COMPANY AND VSTOCK TRANSFER, LLC (THE "WARRANT AGENT") DATED MAY 12, 2022 (THE "WARRANT AGREEMENT")**

On December [ ], 2022, Prime Number Acquisition I Corp. (the "Company"), Prime Number Holding Limited, a Cayman Islands exempted company limited by shares ("PubCo"), Prime Number Merger Sub Inc., a Delaware corporation and a wholly-owned subsidiary of PubCo ("Merger Sub"), [ ]<sup>1</sup>, a Singapore private company limited by shares and a direct wholly-owned Subsidiary of PubCo ("New SubCo"), NOCO-NOCO PTE. LTD., a Singapore private company limited by shares, with its Unique Entity Number being 201924194K ("Target"), and certain shareholders of Target entered into a business combination agreement (as may be amended, supplemented or otherwise modified from time to time, the "Business Combination Agreement"), pursuant to which (a) the Company shall merge with and into Merger Sub, with the Company continuing as the surviving entity (the "Merger"), as a result of which, (i) the Company shall become a wholly-owned subsidiary of PubCo and (ii) all of the issued and outstanding securities of the Company immediately prior to the effective time of the Merger shall no longer be outstanding and shall automatically be cancelled, in exchange for the right of the holders thereof to receive substantially equivalent securities of PubCo, and (b) New SubCo shall acquire all of the issued and outstanding Target Ordinary Shares from the shareholders of Target, and in exchange, PubCo shall issue to the selling shareholders of Target certain ordinary shares of PubCo, in each case, upon the terms and subject to the conditions set forth in the BCA and in accordance with applicable laws (the "Share Exchange").

Terms defined in the Warrant Agreement shall have the same meaning in this notice unless the context otherwise requires.

In accordance with Sections 4.5 of the Warrant Agreement, and pursuant to the terms of the Business Combination Agreement, we hereby give you notice that with effect from completion of the Merger, the Warrants (as defined in the Warrant Agreement) shall be exercisable, pursuant to the terms of the Warrant Agreement, for ordinary shares of PubCo ("PubCo Ordinary Shares"), on the basis that each Warrant shall give the holder the right to purchase from PubCo one PubCo Ordinary Share for a Warrant Price of \$11.50 per share.

---

<sup>1</sup> NTD: To insert New SubCo name

---

Yours sincerely

---

Dongfeng Wang  
Director  
For and on behalf of  
**Prime Number Acquisition I Corp.**

---

Dongfeng Wang  
Director  
For and on behalf of  
**Prime Number Holding Limited**

Copies:

Robinson & Cole LLP  
666 Third Avenue, 20th Floor  
New York, NY 10017  
Attention: Arila E. Zhou  
Email: azhou@rc.com

Sidley Austin LLP  
39/F, Two Int'l Finance Centre  
Central, Hong Kong  
Attention: Raymond Oh  
Email: roh@sidley.com

---

**Prime Number Holding Limited**

89 Nexus Way, Camana Bay  
 Grand Cayman, KY1-9009  
 Cayman Islands

**D** +852 3656 6054  
 +852 3656 6061  
**E** [nathan.powell@ogier.com](mailto:nathan.powell@ogier.com)  
[florence.chan@ogier.com](mailto:florence.chan@ogier.com)

Reference: FYC/AGA/504747.00001

[date] 2023

Dear Sirs

**Prime Number Holding Limited (the Company)**

We have been requested to provide you with an opinion on matters of Cayman Islands law in relation to the Company's registration statement filed with the Securities and Exchange Commission (the **Commission**) under the United States Securities Act of 1933, as amended (the **Securities Act**), on Form F-4, such registration statement including all amendments or supplements to such form filed with the Commission (the **Registration Statement**). The Registration Statement relates to the transactions contemplated in the business combination agreement dated as of 29 December 2022 (the **Agreement**) by and among (i) Prime Number Acquisition I Corp. (the **Acquiror**), (ii) the Company; (iii) Prime Number Merger Sub Inc. (the **Merger Sub**); (iv) Prime Number New Pte. Ltd. (the **New SubCo**); (v) NOCO-NOCO PTE. LTD. (the **Target**); and (vi) certain shareholders of the Target, pursuant to which the Company will issue the following securities (the **Securities**) as will be determined in accordance with the Agreement:

- (a) such number of ordinary shares with US\$0.0001 par value each of the Company (each an **Ordinary Share**) to the existing shareholders of the Acquiror (including, without limitation, the Ordinary Shares issuable to the existing rights holder of the Acquiror) (collectively, the **SPAC Shares**) as set out in the Registration Statement and in accordance with the terms of the Agreement;
- (b) up to an aggregate of [131,707,318] of Ordinary Shares to the existing shareholders of the Target (the **Consideration Shares**, and together with the SPAC Shares, the **Offering Shares**) in accordance with the terms of the Agreement; and
- (c) such number of warrants to purchase Ordinary Shares to the existing warrant holders of the Acquiror (the **Warrants**) in accordance with the terms of the Agreement and the Warrant Assumption Agreement (as defined below).

This opinion letter is given in accordance with the terms of the legal matters section of the Registration Statement.

Unless a contrary intention appears, all capitalised terms used in this opinion have the respective meanings set forth in the Registration Statement. A reference to a Schedule is a reference to a schedule to this opinion and the headings herein are for convenience only and do not affect the construction of this opinion.

**Ogier**

British Virgin Islands, Cayman Islands,  
 Guernsey, Jersey and Luxembourg practitioners

Floor 11 Central Tower  
 28 Queen's Road Central  
 Central  
 Hong Kong

T +852 3656 6000  
 F +852 3656 6001  
[ogier.com](http://ogier.com)

**Partners**

Nicholas Plowman  
 Nathan Powell  
 Anthony Oakes  
 Oliver Payne  
 Kate Hodson  
 David Nelson  
 Michael Snape  
 Justin Davis

Florence Chan  
 Lin Han  
 Cecilia Li  
 Rachel Huang  
 Richard Bennett  
 James Bergstrom  
 Marcus Leese

## 1 Documents examined

For the purposes of giving this opinion, we have examined the corporate and other documents and conducted the searches listed in Schedule 1. We have not made any searches or enquiries concerning, and have not examined any documents entered into by or affecting the Company or any other person, save for the searches, enquiries and examinations expressly referred to in Schedule 1.

## 2 Assumptions

In giving this opinion we have relied upon the assumptions set forth in this paragraph 2 without having carried out any independent investigation or verification in respect of those assumptions:

- (a) all original documents examined by us are authentic and complete;
- (b) all copy documents examined by us (whether in facsimile, electronic or other form) conform to the originals and those originals are authentic and complete;
- (c) all signatures, seals, dates, stamps and markings (whether on original or copy documents) are genuine;
- (d) each of the Good Standing Certificate, the Statutory Books and the Director's Certificate is accurate and complete as at the date of this opinion;
- (e) all copies of the Registration Statement are true and correct copies and the Registration Statement conform in every material respect to the latest drafts of the same produced to us and, where the Registration Statement has been provided to us in successive drafts marked-up to indicate changes to such documents, all such changes have been so indicated;
- (f) the Board Resolutions have not been amended, varied or revoked in any respect;
- (g) the Warrant Assumption Agreement will be duly executed, dated and delivered by all parties thereto in materially the same form as the last draft examined by us such that the Company will assume the obligations of the Acquiror under the Original Warrant Agreement;
- (h) neither the sole director of the Company (the **Sole Director**) or the sole shareholder of the Company have taken any steps to appoint a liquidator of the Company and no receiver has been appointed over any of the Company's property or assets;

- (i) the draft amended and restated articles of association appended to the Registration Statement will be adopted by the Company in accordance with the Memorandum and Articles of Association prior to the date that any Offering Shares are issued by the Company; and
- (j) there is no provision of the law of any jurisdiction, other than the Cayman Islands, which would have any implication in relation to the opinions expressed herein

### 3 Opinions

On the basis of the examinations and assumptions referred to above and subject to the qualifications set forth in Schedule 2 and the limitations set forth below, we are of the opinion that:

#### Corporate status

- (a) The Company has been duly incorporated as an exempted company and is validly existing and in good standing with the Registrar of Companies of the Cayman Islands (the **Registrar of Companies**).

#### Securities

- (b) The Offering Shares to be offered and issued by the Company as contemplated by the Registration Statement and the Agreement have been duly authorised for issue and when:
  - (i) issued by the Company against payment in full of the consideration thereof in accordance with the terms set out in the Registration Statement, the Agreement and the Company's then effective memorandum and articles association; and
  - (ii) such issuances of Offering Shares have been duly registered in the Company's register of members as fully paid shares,will be validly issued, fully paid and non-assessable.
- (c) The Warrants to be issued by the Company as contemplated by the Registration Statement, the Agreement and the Warrant Agreement have been duly authorised for issue and when issued by the Company against payment in full of the consideration thereof in accordance with the terms set out in the Registration Statement, the Agreement, the Warrant Agreement and the Company's then effective memorandum and articles association and all conditions set forth in the Warrant Agreement have been satisfied, will be validly issued and fully paid.
- (d) Any Ordinary Shares which are to be issued pursuant to the Warrants, in each case when the Warrants are exercisable under the terms of the Warrants and the Warrant Agreement as referred to within the Registration Statement, have been duly authorised for issue and, when:
  - (i) issued by the Company upon due exercise of the Warrants in accordance with the terms of the Warrants and the Warrant Agreement as referred to in the Registration Statement and in accordance with the Company's then effective memorandum and articles association; and
  - (ii) such issuances of Ordinary Shares have been duly registered in the Company's register of members as fully paid shares,will be, subject to payment of the exercise price therefor under the terms of the Warrants, validly issued, fully paid and non-assessable.

#### **4 Matters not covered**

We offer no opinion:

- (a) as to any laws other than the laws of the Cayman Islands, and we have not, for the purposes of this opinion, made any investigation of the laws of any other jurisdiction, and we express no opinion as to the meaning, validity, or effect of references in the Documents to statutes, rules, regulations, codes or judicial authority of any jurisdiction other than the Cayman Islands;
- (b) except to the extent that this opinion expressly provides otherwise, as to the commercial terms of, or the validity, enforceability or effect of the documents reviewed (or as to how the commercial terms of such documents reflect the intentions of the parties), the accuracy of representations, the fulfilment of warranties or conditions, the occurrence of events of default or terminating events or the existence of any conflicts or inconsistencies among the documents and any other agreements into which the Company may have entered or any other documents; or
- (c) as to whether the acceptance, execution or performance of the Company's obligations under the documents reviewed by us will result in the breach of or infringe any other agreement, deed or document (other than the Memorandum and Articles of Association) entered into by or binding on the Company.

#### **5 Governing law of this opinion**

5.1 This opinion is:

- (a) governed by, and shall be construed in accordance with, the laws of the Cayman Islands;
- (b) limited to the matters expressly stated in it; and
- (c) confined to, and given on the basis of, the laws and practice in the Cayman Islands at the date of this opinion.

5.2 Unless otherwise indicated, a reference to any specific Cayman Islands legislation is a reference to that legislation as amended to, and as in force at, the date of this opinion.

#### **6 Who can rely on this opinion**

6.1 This opinion is given for your benefit in connection with the Company. With the exception of your professional advisers (acting only in that capacity) and purchasers of the Offering Shares and Warrants pursuant to the Registration Statement, it may not be relied upon by any person, other than persons entitled to rely upon it pursuant to the provisions of the Act, without our prior written consent.

6.2 We hereby consent to the filing of this opinion as an exhibit to the Registration Statement. We also consent to the reference to this firm in the Registration Statement under the heading "Legal Matters" and "Enforcement of Civil Liabilities".

Yours faithfully

**Ogier**



## SCHEDULE 1

### List of Documents Examined

- 1 The certificate of incorporation of the Company dated 28 December 2022 issued by the Registrar of Companies.
- 2 The memorandum and articles of association of the Company dated 28 December 2022 (the **Memorandum and Articles of Association**).
- 3 The draft form of the amended and restated memorandum and articles of association of the Company appended to the Registration Statement to be adopted by the Company with effect from the closing of the Offering.
- 4 A certificate of good standing dated [date] 2023 issued by the Registrar of Companies in respect of the Company (the **Good Standing Certificate**).
- 5 The written resolutions of the Sole Director dated 3 February 2023 and [date] 2023 (together, the **Board Resolutions**).
- 6 The register of members of the Company as at 19 January 2023 (the **Register of Members**)
- 7 The register of directors and officers of the Company as at 19 January 2023 (the **Register of Directors**, and together with the Register of Members, the **Statutory Books**).
- 8 A certificate from a director of the Company dated [date] 2023 as to certain matters of fact (the **Director's Certificate**).
- 9 The Registration Statement.
- 10 The Agreement.
- 11 A draft warrant assumption agreement to be entered into by the Company, Acquiror and VStock Transfer, LLC, the form of which is annexed to the Agreement and exhibited in the Registration Statement (the **Warrant Assumption Agreement**).
- 12 The warrant agreement between the Acquiror and VStock Transfer, LLC dated 12 May 2022 (the **Original Warrant Agreement**, and together with the Warrant Assumption Agreement, the **Warrant Agreement**).
- 13 The Register of Writs maintained by the office of the Clerk of Courts in the Cayman Islands as inspected by us on [date] 2023.

## SCHEDULE 3

### Qualifications

#### Good Standing

- 1 Under the Companies Act, annual returns in respect of the Company must be filed with the Registrar of Companies, together with payment of annual filing fees. A failure to file annual returns and pay annual filing fees may result in the Company being struck off the Register of Companies, following which its assets will vest in the Financial Secretary of the Cayman Islands and will be subject to disposition or retention for the benefit of the public of the Cayman Islands.
- 2 **In good standing** means only that as of the date of the Good Standing Certificate the Company is up-to-date with the filing of its annual returns and payment of annual fees with the Registrar of Companies. We have made no enquiries into the Company's good standing with respect to any filings or payment of fees, or both, that it may be required to make under the laws of the Cayman Islands other than the Companies Act.

#### Register of Writs

- 3 Our examination of the Register of Writs cannot conclusively reveal whether or not there is:
  - (a) any current or pending litigation in the Cayman Islands against the Company; or
  - (b) any application for the winding up or dissolution of the Company or the appointment of any liquidator or trustee in bankruptcy in respect of the Company or any of its assets,

as notice of these matters might not be entered on the Register of Writs immediately or updated expeditiously or the court file associated with the matter or the matter itself may not be publicly available (for example, due to sealing orders having been made). Furthermore, we have not conducted a search of the summary court. Claims in the summary court are limited to a maximum of CI \$20,000.



Chrysler East Building  
666 Third Avenue, 20th floor  
New York, NY 10017

[ ], 2023

Prime Number Holding Limited  
1129 Northern Blvd., Suite 404  
Manhasset, NY 11030

Re: Registration Statement on Form F-4

Ladies and Gentlemen:

We have been engaged as U.S. securities counsel by Prime Number Acquisition I Corp., a Delaware company (the “Company”), in connection with the Registration Statement on Form F-4 of Prime Number Holding Limited, an exempted company limited by shares incorporated under the laws of the Cayman Islands (“PubCo”), as amended and supplemented through the date hereof (the “Registration Statement”), filed with the U.S. Securities and Exchange Commission under the Securities Act of 1933, as amended (the “Act”), including the proxy statement/prospectus forming a part thereof, relating to [138,963,568] ordinary shares of PubCo, par value \$0.0001 per share (the “Ordinary Shares”), and [3,225,000] warrants of PubCo (the “Warrants”), to be issued by PubCo pursuant to the business combination agreement dated December 29, 2022 (as amended, supplemented or modified from time to time, the “Business Combination Agreement”), by and among the Company, PubCo, Prime Number Merger Sub Inc., a Delaware corporation and subsidiary of PubCo (the “Merger Sub”), Prime Number New Sub Pte. Ltd., a Singapore private company limited by shares and subsidiary of PubCo (the “New SubCo”), NOCO-NOCO PTE. LTD., a Singapore private company limited by shares (“Noco-Noco”), and certain shareholders of Noco-Noco. Unless otherwise indicated, each capitalized term used herein has the meaning ascribed to it in the Registration Statement.

In rendering the opinions set forth below, we have examined originals or copies, certified or otherwise identified to our satisfaction, of: (i) the Registration Statement; (ii) the Business Combination Agreement; (iii) the board resolutions of the Company dated as of December 29, 2022 in connection with the Business Combination Agreement and the Business Combination; (iv) the form of a draft warrant assumption agreement to be entered into by the Company, PubCo and VStock Transfer, LLC (the “Warrant Assumption Agreement”), the form of which is attached as an annex to the Business Combination Agreement and included as an exhibit to the Registration Statement; and (v) the form of a letter notice from the Company and PubCo to VStock Transfer, LLC regarding the Warrant Agreement dated May 12, 2022 by and between the Company and VStock Transfer, LLC, the form of which is included as an exhibit to the Registration Statement. We have also examined originals or copies, certified or otherwise identified to our satisfaction, of such records of the Company and such agreements, certificates and receipts of public officials, certificates of officers or other representatives of the Company, PubCo and others, and such other documents, certificates and records as we have deemed necessary or appropriate as a basis for the opinions set forth below.

---

Boston | Hartford | New York | Providence | Miami | Stamford | Los Angeles | Wilmington | Philadelphia | Albany | New London | [rc.com](http://rc.com)

Robinson & Cole LLP

---



In our examination, we have assumed the legal capacity of all natural persons, the genuineness of all signatures, the authenticity of all documents submitted to us as originals, the conformity to original documents of all documents submitted to us as facsimile, electronic, certified or photostatic copies, and the authenticity of the originals of such copies. In making our examination of executed documents, we have assumed that the parties thereto had the power, corporate or other, to enter into and perform all obligations thereunder and have also assumed the due authorization by all requisite action, corporate or other, and the execution and delivery by such parties of such documents and the validity and binding effect thereof on such parties. As to any facts material to the opinions expressed herein that we did not independently establish or verify, we have relied upon statements and representations of officers and other representatives of the Company, PubCo and others, and of public officials.

Based upon the foregoing, we are of the opinion that: When the Registration Statement becomes effective under the Act and when the Warrants are issued, delivered and paid for as part of the Business Combination, as contemplated by the Registration Statement and in accordance with the terms of the Business Combination Agreement and the Warrant Assumption Agreement, such Warrants will be legally binding obligations of the PubCo enforceable in accordance with their terms except: (a) as such enforceability may be limited by bankruptcy, insolvency, reorganization or similar laws affecting creditors' rights generally and by general equitable principles (regardless of whether enforceability is considered in a proceeding in equity or at law); (b) as enforceability of any indemnification or contribution provision may be limited under the federal and state securities laws; (c) that the remedy of specific performance and injunctive and other forms of equitable relief may be subject to the equitable defenses and to the discretion of the court before which any proceeding therefor may be brought; (d) we express no opinion as to whether a state court outside of the State of New York or a federal court of the United States would give effect to the choice of New York law provided for in the Warrant Assumption Agreement; (e) with respect to the Ordinary Shares, we express no opinion to the extent that future issuances of securities, including the Ordinary Shares, of the PubCo and/or adjustments to outstanding securities, including the Warrants, of the PubCo may cause the Warrants to be exercisable for more Ordinary Shares than the number that remain authorized but unissued; and (f) we have assumed that the exercise price of the Warrants, as specified in the Warrant Assumption Agreement, will not be adjusted to an amount below the par value per Ordinary Share.

Our opinion herein is expressed solely with respect to the legally binding obligations of the Company with respect to the Warrants, solely with respect to the laws of the State of New York. Our opinion is based on these laws as in effect on the date hereof and as of the effective date of the Registration Statement, and we assume no obligation to revise or supplement this opinion after the effective date of the Registration Statement should the law be changed by legislative action, judicial decision or otherwise. Where our opinions expressed herein refer to events to occur at a future date, we have assumed that there will have been no changes in the relevant law or facts between the date hereof and such future date. Our opinions expressed herein are limited to the matters expressly stated herein and no opinion is implied or may be inferred beyond the matters expressly stated. Not in limitation of the foregoing, we are not rendering any opinion as to the compliance with any other federal or state law, rule or regulation relating to securities, or to the sale or issuance thereof.

---



We hereby consent to the use of this opinion as an exhibit to the Registration Statement, to the use of our name as U.S. securities counsel of the Company and to all references made to us under the caption “Legal Matters” in the Registration Statement and in the proxy statement/prospectus forming a part thereof. In giving this consent, we do not hereby admit that we are in the category of persons whose consent is required under Section 7 of the Act, or the rules and regulations promulgated thereunder.

Very truly yours,

[draft]  
ROBINSON + COLE LLP

---



Prime Number Capital LLC,  
FINRA/SIPC Member  
14 Myrtle Dr, Great Neck, New York, 11021  
(347) 329-1585  
[info@pncps.com](mailto:info@pncps.com)

---

April 30, 2023

Prime Number Acquisition I Corp.  
1129 Northern Blvd, Suite 404, Manhasset, NY

Attention: Mr. Dongfeng Wang, Mr. Weixiong (Jeff) Cheong

Re: Engagement of Services

Ladies and Gentlemen:

This letter will confirm our understanding that the company known to us as Prime Number Acquisition I Corp. (the "**Company**"), has engaged Prime Number Capital LLC ("**PNCPS**") (the "**Placement Agent**") to act as PIPE Placement Agent in connection with any private placement of securities (the "**Securities**") by the Company in connection with a Transaction (a "**Placement**"). The specific terms and conditions of the Transaction and Placement shall be determined by good faith negotiations between the Company and the counterparty(s) to the Transaction or Placement, as applicable. References herein to the "Company" shall be deemed to include any entity that the Company may form or utilize to effect any of the Transactions contemplated hereby.

**Section 1. Scope of Engagement and Services.** The Company hereby engages Placement Agent, for the period beginning on the date hereof and ending on the earlier of the close of the Transaction or the liquidation of the Company (the "**Engagement Period**").

It is expressly understood and acknowledged that Placement Agent's engagement as placement agent does not constitute any commitment, express or implied, on the part of Placement Agent or of any of its affiliates to purchase or place any Securities or to provide any type of financing and that the Placement will be made by Placement Agent on a reasonable effort basis. It is further understood that Placement Agent's services hereunder shall be subject to, among other things, satisfactory completion of due diligence by Placement Agent, market conditions, the absence of adverse changes to the Acquisition Target's business or financial condition, approval of Placement Agent's internal committee and any other conditions that Placement Agent may deem appropriate for placements of such nature.

It is expressly understood and agreed that Placement Agent is not undertaking to provide any advice relating thereof, the Company acknowledges and agrees that (a) it and its affiliates have relied and will continue to rely on the advice of its own legal, regulatory, accounting and tax advisors for all matters relating to any Transaction and Placement, and all other matters and (b) neither it, nor any of its affiliates, has received, or has relied upon, the advice of Placement Agent or any of its affiliates regarding matters of law, regulation, accounting or taxation.

---

**Section 2. Indemnification.** The Company agrees to indemnify Placement Agent in accordance with the provisions of **Exhibit A** hereto, which is incorporated by reference and made a part hereof.

**Section 3. Placement Agent's and the Company's Relationships with Others.** The Company acknowledges that Placement Agent and its affiliates are in the business of providing investment banking, financial advisory, and consulting services to others and agrees that the provision of such services shall not constitute a breach hereof of any duty owed to the Company by virtue of this Agreement. Nothing contained herein, other than Placement Agent's obligations relating to the Company's Confidential Material as provided in Section 4 hereof, shall be construed to limit or restrict Placement Agent or its respective affiliates in conducting such businesses with respect to others or in rendering such services to others.

**Section 4. Confidential Information.** In connection with the rendering of services hereunder, Placement Agent has been or will be furnished with certain confidential information of the Company including, but not limited to, financial statements and information, cost and expense data, scientific data, intellectual property, trade secrets, business strategies, marketing and customer data, and such other information not generally available from public or published information sources. Such information shall be deemed "Confidential Material", shall be used solely in connection with the provision of services contemplated hereby, and shall not be disclosed by Placement Agent without the prior written consent of the Company. In the event Placement Agent is required by applicable law or legal process to disclose any of the Confidential Material, Placement Agent will deliver to the Company prompt notice of such requirement (by fax or overnight courier promptly following Placement Agent's knowledge or determination of such requirement) prior to such disclosure so the Company may seek an appropriate protective order and/or waive compliance of this provision. If, in the absence of a protective order (because the Company elected to not seek such an order or it was denied by a court of competent jurisdiction) or receipt of written waiver, Placement Agent is nonetheless, in the written opinion of its counsel, compelled to disclose any Confidential Material, Placement Agent may do so without liability hereunder. Placement Agent may also, without prior notice to the Company, disclose Confidential Information pursuant to an ordinary course examination by, or other ordinary course interaction with, a regulator, bank examiner or self-regulatory organization (such as FINRA).

**Section 5. Limitation Upon the Use of Advice and Services**

- (a) No person or entity, other than the Company (including its directors, officers, and employees), shall be entitled to make use of, or rely upon any advice of Placement Agent to be given hereunder, and the Company shall not transmit such advice to, or encourage or facilitate the use or reliance upon such advice by others without the prior written consent of Placement Agent
  - (b) The Company hereby acknowledges that Placement Agent, for services rendered as contemplated by this Agreement, does not make any commitment whatsoever to make a market in any of the Company's securities on any stock exchange or in any electronic marketplace. Any decision by Placement Agent to make a market in any of the Company's securities shall be based solely on the independent judgment of Placement Agent's management, employees, and agents.
-

(c) Use of Placement Agent's name in annual reports or any other report of the Company or releases by the Company requires the prior written approval of Placement Agent unless the Company is required by law to include Placement Agent's name in such annual reports, other report or release of the Company, in which event the Company shall furnish to Placement Agent copies of such annual reports or other reports or releases using Placement Agent's names in advance of publication by the Company.

**Section 6. Public Announcements.** The Company agrees to include Placement Agent as PIPE placement agent to the Company in any public announcements associated with the Transaction and that Placement Agent may place announcements or advertisements or otherwise publicize Placement Agent's role hereunder.

**Section 7. No Conflicts with Finders or Other Brokers.** The Company represents that this Agreement does not conflict with any other finder or broker agreement entered into by Company, and that if another person or entity is entitled to payment by Company of a finder's fee or any type of brokerage commission in connection with any Transactions contemplated by this Agreement as a result of any agreement or understanding with the Company, this will not reduce Company's obligations to Placement Agent hereunder.

**Section 8. Right of First Refusal.** From the closing of the Transaction, Company shall give Placement Agent a right of first refusal to act as a book-running manager for the first two (2) public or private equity or debt offerings by the Company or any successor to or any subsidiary of the Company, or the surviving entity as a result of business combination.

**Section 9. Fees and Reimbursement.** As compensation for Placement Agent's services as Placement Agent, Placement Agent shall receive a placement fee (the "**Placement Fee**") of seven percent (7.0% of the aggregate gross proceeds received by the Company from the sale of the Securities in the Placement. The Placement Fee shall be payable in immediately available funds on the date that the Company receives payment (the "Closing Date") for the Securities (not subject to any escrow or similar arrangement, in which case the Placement Fee shall be payable on the date such funds are released to the Company from such escrow or similar relationship) from a purchaser (the "**Purchaser**") of the Securities.

The Company shall, whether or not any Transaction or Placement is consummated, reimburse Placement Agent for any reasonable out-of-pocket expenses reasonably incurred in connection with Placement Agent's obligations hereunder, including without limitation, (a) travel expenses and (b) the professional fees and expenses incurred by Placement Agent, including reasonable fees and expenses of counsel, up to \$50,000 in the aggregate.

The right of Placement Agent to receive the fees and reimbursements set forth in this Section 9 shall survive the termination of this Agreement for any reason.

---



**Section 10. Information; Cooperation.** The Company will cooperate with and will furnish Placement Agent with all reasonable information and data concerning the Company and the Transaction which Placement Agent deems appropriate and will provide Placement Agent with reasonable access to the Company's officers, directors, employees, independent accountants, and legal counsel. The Company represents that all information and any disclosure materials made available to Placement Agent for distribution to investors will be complete and correct in all material respects and will not contain any untrue statement of material fact or omit to state a material fact necessary in order to make the statements therein not misleading in light of the circumstances under which such statements are made. The Company further represents and warrants that to the extent any projections are furnished, such projections will have been prepared in good faith and will be based upon assumptions, which, in light of the circumstances under which they are made, are reasonable. Placement Agent shall not, and shall cause any of its selected sub-advisors not to, deliver to any prospective investors any information concerning the Company, unless the Company has previously consented to the distribution of such information.

**Section 11. Additional Agreements.** The Company agrees with Placement Agent that:

- (a) The Company (i) will not solicit offers to buy, or offer or sell, the Securities by any form of general solicitation or general advertising (as those terms are used in Regulation D under the Securities Act), or in any manner involving a public offering within the meaning of Section 4(a)(2) of the Securities Act, and (ii) will solicit offers for Securities only from, and will offer Securities only to, investors that it reasonably believes are institutional "accredited investors" within the meaning of Rule 501(a) under the Securities Act of 1933, as amended (the "Securities Act") or "qualified institutional buyers" within the meaning of Rule 144A under the Securities Act. In addition, the Company will take all other necessary steps to ensure that the offering and sale of the Securities are exempt from the registration requirements of the Securities Act and in compliance with all applicable state securities laws.
  - (b) The Company shall extend to all prospective purchasers the opportunity, prior to the closing of a Placement, to ask questions of, and receive answers from, the Company, and shall use commercially reasonable efforts to extend to all prospective purchasers and other interested parties the opportunity, prior to such closing, to ask questions of, and receive answers from the Acquisition Target, concerning the Securities and the terms and conditions of the offering thereof and to obtain any information that such prospective purchasers may consider necessary in making an informed investment decision or to verify the accuracy of the information set forth in any offering materials prepared and used by the Company in connection with a Placement (the "Offering Materials"), to the extent the Company possesses the same or can acquire it without unreasonable effort or expense.
  - (c) If any event occurs or condition exists as a result of which the Offering Materials or the information contained in any of the Company's reports filed under the Securities Exchange Act of 1934, as amended (the "Exchange Act"), would include an untrue statement of a material fact, or omit to state any material fact necessary to make the statements therein, in the light of the circumstances when the Offering Materials are delivered to a Purchaser or such filings were made, as the case may be, not misleading, or if, in the opinion of Placement Agent or the Company, it is necessary at any time to amend or supplement the Offering Materials or file a subsequent Exchange Act report, as the case may be, to comply with applicable law, the Company will immediately notify Placement Agent of any such event, condition or opinion of the Company and shall prepare an amendment or supplement to the Offering Materials or Exchange Act report, as the case may be, that will correct such statement or omission or effect such compliance and will supply such amended or supplemented Offering Materials or Exchange Act report, as the case may be, to Placement Agent, provided that in the case of any such opinion of Placement Agent, the Company would only be required to do so upon notice from Placement Agent.
-

- (d) Placement Agent shall be a third-party beneficiary of, and shall be entitled to rely on, the representations and warranties provided by the Company to the Purchasers, and by the Purchasers to the Company, in any definitive agreement (the “**Definitive Agreement**”) entered into regarding the Placement. The Definitive Agreement between the Company and the Purchasers will contain representations of each Purchaser (for itself and for each account for which such Purchaser is acquiring Securities) that such Purchaser has carefully reviewed any Offering Materials used in the Placement and has been furnished with all other materials that it considers relevant to an investment in the Securities, has had a full opportunity to ask questions of and receive answers from the Company or any person or persons acting on behalf of the Company concerning the terms and conditions of the Placement, and no statement or printed material which is contrary to the disclosure documents has been made or given to the Purchaser by or on behalf of the Company; and that the Purchaser is not relying upon, and has not relied upon, any statement, representation or warranty made by any person, including, without limitation, Placement Agent, except for the statements, representations and warranties contained in the Definitive Agreement. The Company will cause to be furnished to Placement Agent a copy of the closing documents with respect to the Placement. To the extent the Company’s counsel shall deliver a legal opinion in connection with the Placement to the Purchasers of the Securities, such opinion shall also be addressed to Placement Agent (or shall state that Placement Agent is entitled to rely on such opinion).

**Section 12. Miscellaneous.**

- (a) Any notice or communication between the parties hereto shall be sufficiently given if sent by certified or registered mail, postage prepaid and if to the Company, addressed to it at the address above, or if to Placement Agent, addressed to them at: 14 Myrtle Drive, Great Neck, NY, 11021; or delivered by facsimile transmission with a printed confirmation of receipt and confirmed, or by electronic transmission via PDF. Such notice or other communication shall be deemed to be given on the date of receipt.
- (b) This Agreement embodies the entire agreement and understanding between the Company and Placement Agent and supersedes any and all negotiations, prior discussions and preliminary and prior agreements and understandings that Placement Agent may have had with the Company related to the subject matter hereof, and may be modified only by a written instrument duly executed by each party. This Agreement shall inure to the benefit of and be binding upon the successors, assigns and personal representatives of each of the parties hereto. This Agreement has been duly authorized, executed and delivered by and on behalf of the Company and Placement Agent.
- (c) This Agreement shall be deemed to have been made and delivered in New York City and shall be governed as to validity, interpretation, construction, effect and in all other respects by the internal laws of the State of New York without regard to principles of conflicts of law thereof. Any and all disputes, controversies or claims arising out of or relating to this Agreement, or the breach, termination or invalidity thereof, shall be finally and exclusively resolved by arbitration in accordance with the Rules of FINRA as at present in force. The arbitration shall take place in New York City, the State of New York. The parties hereby submit themselves to the exclusive jurisdiction of the arbitration tribunal in the City of New York, the State of New York under the auspices of FINRA. To the extent permitted by law, the award of the arbitrators may include, without limitation, one or more of the following: a monetary award, a declaration of rights, an order of specific performance, an injunction, reformation of the contract. The decision of the arbitrators shall be final and binding upon the parties hereto, and judgment on the award may be entered in any court having jurisdiction over the subject matter thereof. Each party to the arbitration shall bear its own expenses of the arbitration (including without limitation reasonable fees and expenses of counsel, experts and consultants).
-

- (d) There is no relationship of partnership, agency, employment, franchise, or joint venture between the parties. No party has the authority to bind the other or incur any obligation on the other's behalf.
- (e) The Company hereby acknowledges that Placement Agent is not a fiduciary of the Company. Placement Agent makes no representations or warranties regarding the Company's ability to secure financing, whether now or in the future.
- (f) This Agreement and the rights hereunder may not be assigned by either party (except by operation of law).
- (g) Any term or provision of this Agreement which is invalid or unenforceable in any jurisdiction shall, as to that jurisdiction, be ineffective to the extent of such invalidity or unenforceability without rendering invalid or unenforceable the remaining terms and provisions of this Agreement or affecting the validity or enforceability of any of the terms or provisions of this Agreement in any other jurisdiction. If any provision of this Agreement is so broad as to be unenforceable, the provision shall be interpreted to be only as broad as is enforceable.

**Section 13. Termination.** The term (the "**Term**") of Placement Agent's engagement hereunder shall commence on the date hereof and shall end on the final closing of the Transaction or Placement; provided however that the Company, with written notice to Placement Agent, may terminate this Agreement for Cause. "Cause" means that the Company's board of directors, acting in good faith, has determined that there has been gross negligence or willful misconduct by Placement Agent or its affiliates.

In the event of any termination of this Agreement prior to the expiration of the Term, this Agreement shall become null and void, except for indemnity obligations of all parties hereunder.

In addition, in the event this Agreement shall be terminated in accordance with the provisions of this Section 13 or upon expiration of this Agreement, the provisions in the sections headed "Confidential Information," "Fees," "Indemnification," and "Miscellaneous" will survive.

*Signature page follows*

---

We are delighted to accept this engagement and look forward to working with you on this assignment. Please confirm that the foregoing is in accordance with your understanding by signing and returning to us one copy of this enclosed duplicate of this agreement.

PRIME NUMBER CAPITAL LLC

By: /s/ Xiaoyan Jiang

Name: Xiaoyan Jiang

Title: Chairwoman

AGREED AND ACCEPTED BY:

PRIME NUMBER ACQUISITION I CORP.

By: /s/ Dongfeng Wang

Name: Dongfeng Wang

Title: Chief Executive Officer

---

## Exhibit A

### INDEMNIFICATION

The Company agrees to indemnify and hold harmless Placement Agent and its affiliates and their respective officers, directors, employees, agents (including Selected Sub-Advisors and/or Dealers) and controlling persons (each such indemnified party or person being an "Indemnified Party"), from and against any losses, claims, damages and liabilities, joint or several, to which such Indemnified Party may become subject under any applicable law, or otherwise, which relate to or arise in any manner out of any transaction or any other matter (collectively, the "Matters") contemplated by the engagement letter, of which this Exhibit A forms a part, and the performance by Placement Agent of the services contemplated thereby, and will promptly reimburse each Indemnified Party for all reasonable expenses (including reasonable fees and expenses of legal counsel) as incurred in connection with the investigation of, preparation for or defense of any pending or threatened claim or any action or proceeding arising therefrom, whether or not such Indemnified Party is a party and whether or not such claim, action or proceeding is initiated or brought by or on behalf of the Company. Notwithstanding the foregoing, the Company shall not be liable under the foregoing to the extent that any loss, claim, damage, liability or expense is found in a final judgment by a court of competent jurisdiction to have resulted solely from Placement Agent's fraud or willful misconduct.

The Company also agrees that no Indemnified Party shall have any liability (whether direct or indirect, in contract or tort or otherwise, save and except that such liability shall be caused by the fraud or willful misconduct of the indemnified party.) to the Company or its security holders or creditors related to, arising out of, or in connection with, any Matters, the engagement of Placement Agent pursuant to, or the performance by Placement Agent of the services contemplated by, the engagement letter, except to the extent any loss, claim, damage or liability if found in a final judgment by a court of competent jurisdiction to have resulted solely from Placement Agent's fraud or willful misconduct.

If the indemnification of an Indemnified Party provided for this letter agreement is for any reason held unenforceable, although otherwise applicable in accordance with its terms, the Company agrees to contribute to the losses, claims, damages and liabilities for which such indemnification is held unenforceable (i) in such proportion as is appropriate to reflect the relative benefits to the Company, on the one hand, and Placement Agent, on the other hand, of any Matter (whether or not the Matter is consummated) or (ii) if (but only if) the allocation provided for in clause (i) is for any reason held unenforceable, in such proportion as is appropriate to reflect not only the relative benefits referred to in clause (i) but also the relative fault of the Company, on the one hand, and Placement Agent, on the other hand, as well as any other relevant equitable considerations. The Company agrees that for the purposes of this paragraph the relative benefits to the Company and Placement Agent of any contemplated Matter (whether or not such Matter is consummated) shall be deemed to be in the same proportion that the total value paid or received or to be paid or received by the Company as a result of or in connection with any Matter, bears to the fees paid or to be paid to Placement Agent under the engagement letter; provided, however, that, to the extent permitted by applicable law, in no event shall the Indemnified Parties be required to contribute an aggregate amount in excess of the aggregate fees actually paid to Placement Agent under the engagement letter of which this Exhibit A is a part.

---

Promptly after receipt by Placement Agent or any other Indemnified Party of any notice of any proceeding, or the commencement of any legal action or proceeding in respect of which indemnity may be sought against the Company, Placement Agent or such other Indemnified Party shall notify the Company promptly in writing of the receipt of any such notice or commencement of such an action or proceeding. In the event the Company shall be obligated under this Indemnification Exhibit to indemnify Placement Agent and/or such other Indemnified Party, the Company may assume and control all aspects of the defense of such proceeding, including, *inter alia*, selection of counsel (which counsel shall be reasonably acceptable to Placement Agent) and, subject to the next paragraph, settlement; provided, however, that the Indemnified Parties shall have the right to retain separate counsel, but the fees and expenses of such counsel shall be at the expense of the Indemnified Parties, unless (i) the employment of such counsel has been specifically authorized in writing by the Company, (ii) the Company has failed to assume the defense and employ reasonably acceptable counsel as required above, or (iii) the named parties to any such action (including any impleaded parties) include both (a) the Indemnified Parties and (b) the Company, and the Indemnified Parties shall have reasonably determined that the defenses available to them are not available to the Company and/or may not be consistent with the best interests of the Company or the Indemnified Parties (in which case the Company shall not have the right to assume the defense of such action on behalf of the Indemnified Parties); it being understood, however, that the Company shall not, in connection with any one such action or separate, substantially similar or related actions in the same jurisdiction arising out of the same general allegations or circumstances, be liable for the reasonable fees and expenses of more than one separate firm of attorneys for the Indemnified Parties, which firm shall be designated in writing by Placement Agent.

The Company agrees that it will not, without the prior written consent of Placement Agent, settle, compromise or consent to the entry of any judgment in any pending or threatened claim, action or proceeding in respect of which indemnification may be sought hereunder (whether or not Placement Agent or any other Indemnified Party is an actual or potential party to such claim, action or proceeding), unless such settlement, compromise or consent includes an unconditional release of such Placement Agent and each other Indemnified Party hereunder from all liability arising out of such claim, action or proceeding.

If Placement Agent or any other Indemnified Party is requested or required to appear as a witness in any action brought by or on behalf of or against the Company in which such party is not named as a defendant, the Company will reimburse Placement Agent for all reasonable expenses incurred in connection with such party's appearing and preparing to appear as such a witness, including, without limitation, the fees and disbursements of its legal counsel.

The provisions of this Exhibit A shall continue to apply and shall remain in full force and effect regardless of any modification or termination of the engagement or engagement letter of which this Exhibit A is a part or the completion of Placement Agent's services thereunder.

---

CONSENT OF INDEPENDENT REGISTERED PUBLIC ACCOUNTING FIRM

We hereby consent to the inclusion in the Registration Statement on Form F-4 Amendment No.1 of Prime Number Holding Limited of our report dated April 3, 2023 with respect to our audit of Prime Number Acquisition I Corp's financial statements as of December 31, 2022 and 2021, for year ended December 31, 2022, and for the period from February 25, 2021 (inception) to December 31, 2021, which appears in the Prospectus as part of this Registration Statement. Our report contained an explanatory paragraph regarding substantial doubt about Prime Number Acquisition I Corp's ability to continue as a going concern.

We also consent to the reference to our Firm under the caption "Experts" in such Prospectus.

/s/ UHY LLP

New York, New York  
June 21, 2023

---



INDEPENDENT REGISTERED PUBLIC ACCOUNTING FIRM'S CONSENT

We consent to the inclusion in this Registration Statement of PRIME NUMBER HOLDING LIMITED on Amendment No.1 to Form F-4 (File No. 333-271994), of our report dated February 10, 2023, with respect to our audits of the financial statements of noco-noco Ptd. Ltd. as of June 30, 2022 and 2021 and for each of the two years in the period ended June 30, 2022, which report appears in the Prospectus, which is part of this Registration Statement. We also consent to the reference to our Firm under the heading "Experts" in such Prospectus.

/s/ Marcum Asia CPAs LLP  
New York, USA  
June 21, 2023

NEW YORK OFFICE • 7 Penn Plaza • Suite 830 • New York, New York • 10001  
Phone 646.442.4845 • Fax 646.349.5200 • [www.marcumasia.com](http://www.marcumasia.com)

---